

DENTAL INSTRUMENTS CATALOGUE.

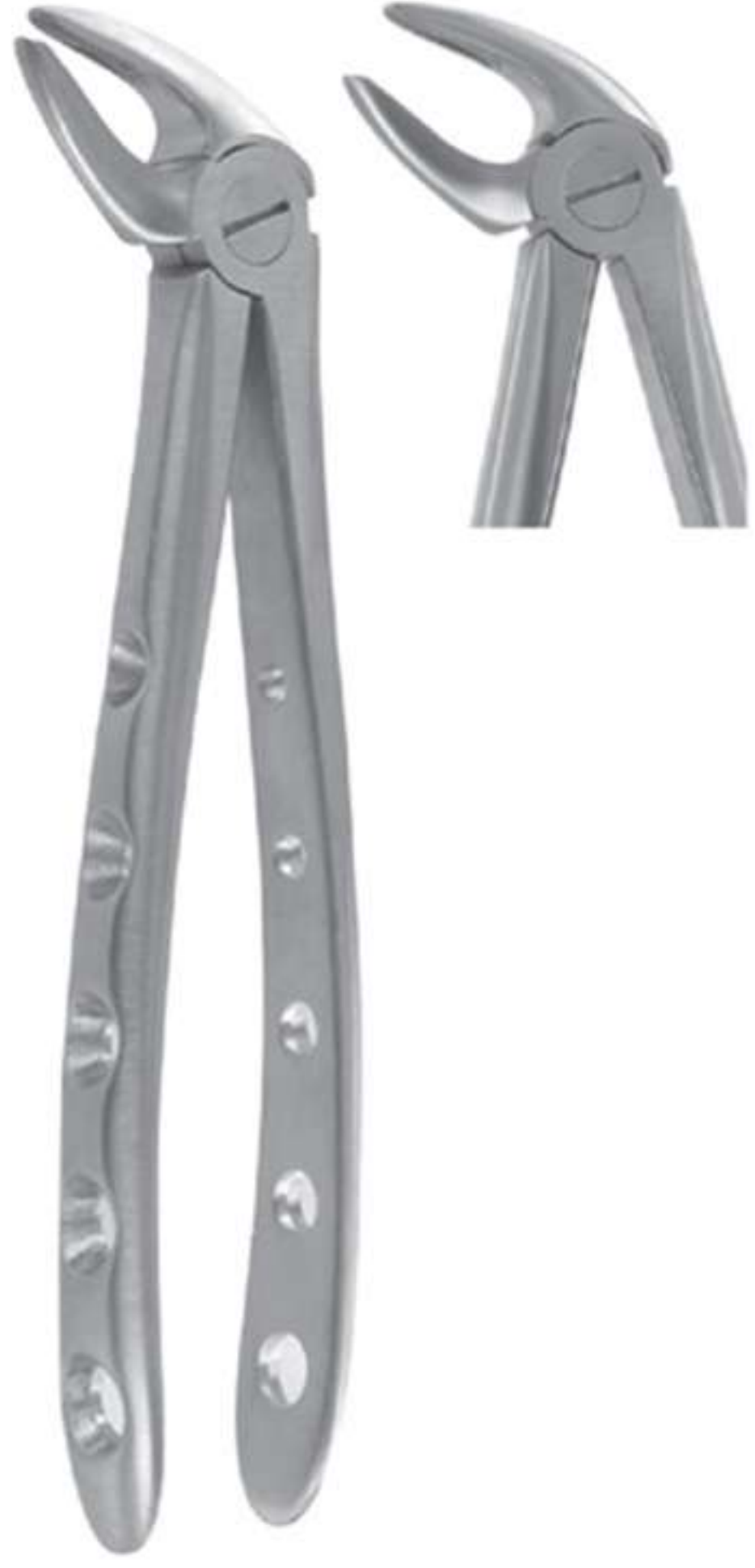

Dentalmountain
INSTRUMENTS

MANUFACTURER & EXPORTER OF DENTAL INSTRUMENTS,



DMI-2-1001
Fig.4, Lower Incisor



DMI-2-1002
Fig. 8, Lower Premolars



DMI-2-1003
Fig.1 Upper Centrals & Canines

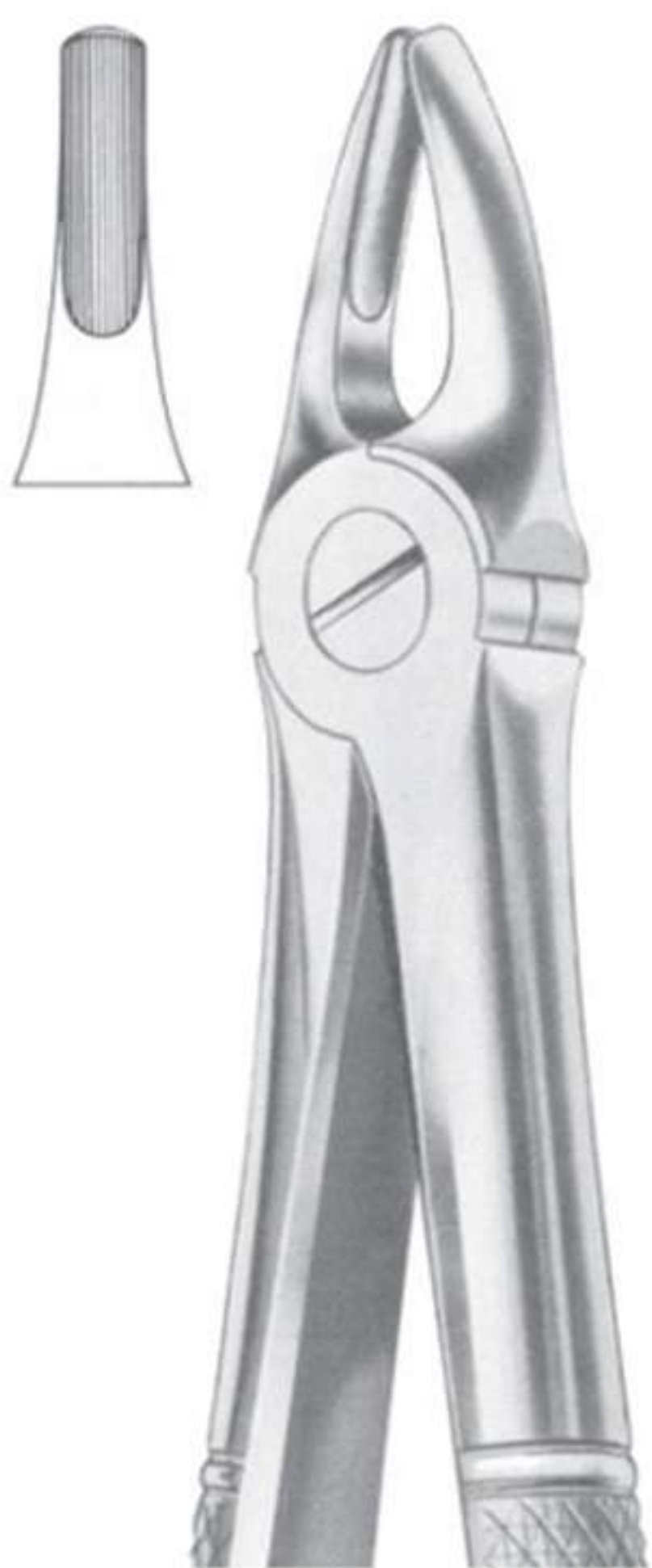

DMI-2-1004
Fig.2 Upper Laterals & Canines



DMI-2-1005
Fig. 3 upper incisors & canines

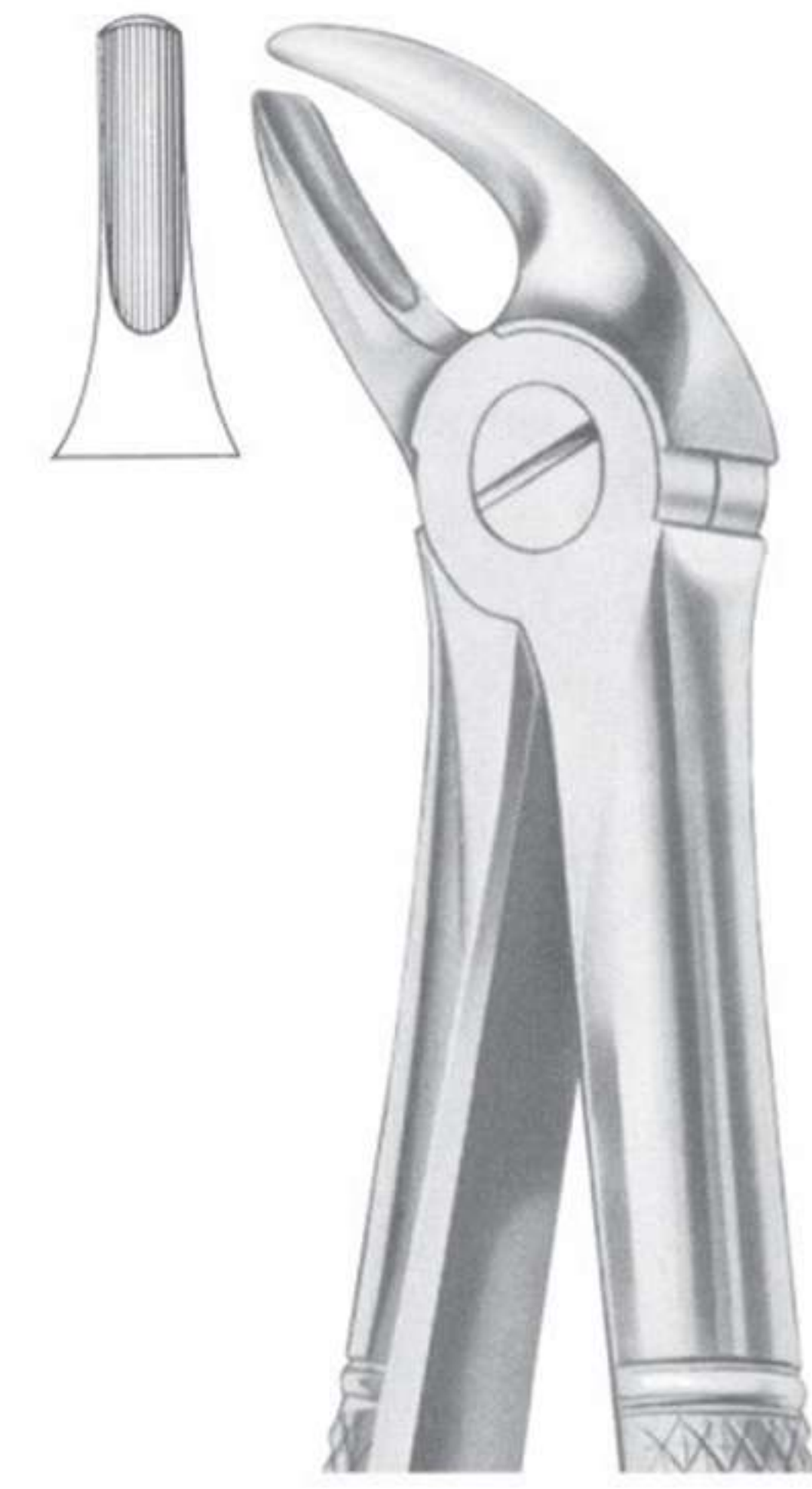

DMI-2-1006
Fig. 4 upper incisors & canines

Extracting Forceps

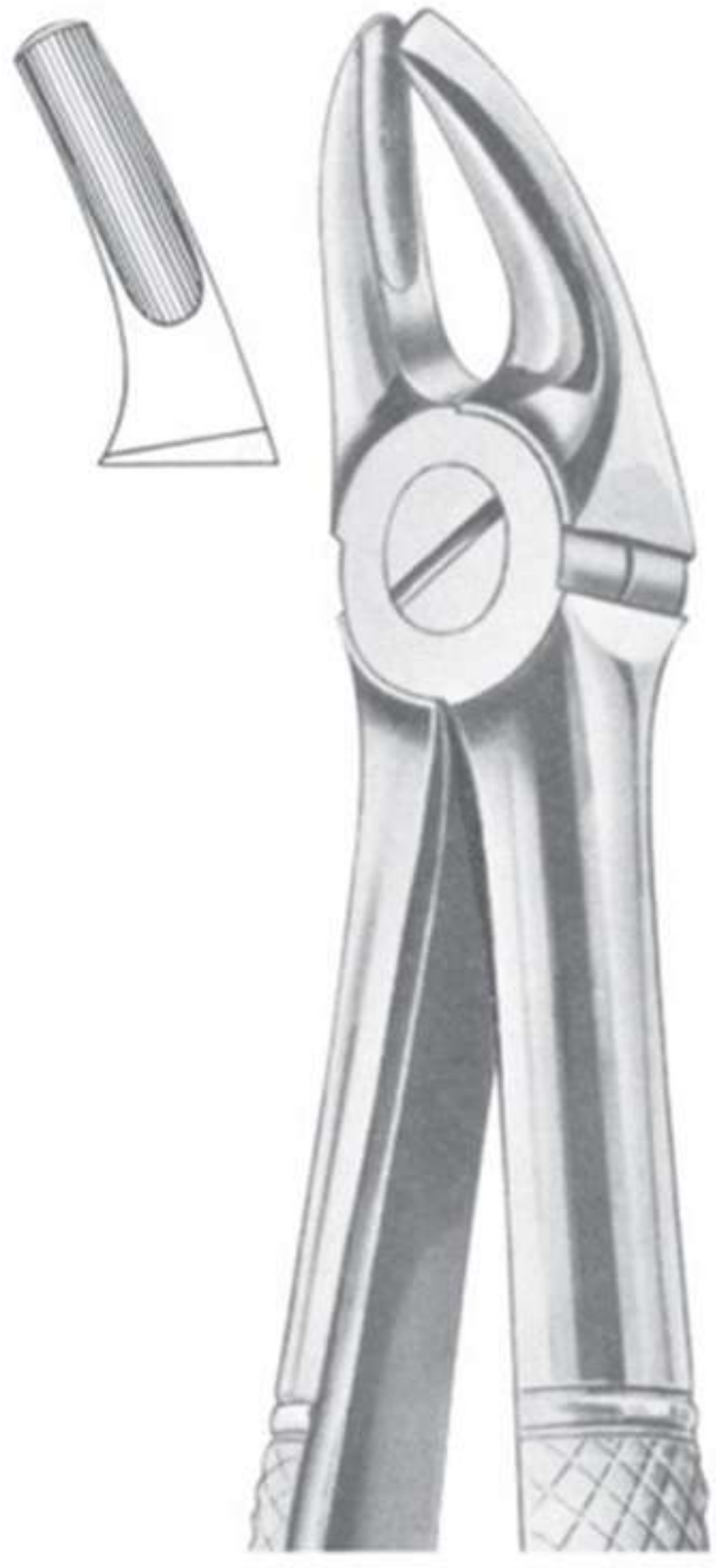

DMI-2-1007
Fig. 7 upper premolars



DMI-2-1008
Fig. 8 lower premolars



DMI-2-1009
Fig. 13 lower premolars



DMI-2-1010
Fig. 13S lower premolars
for children.



DMI-2-1011
FIG. 17 UPPER MOLARS,
RIGHT

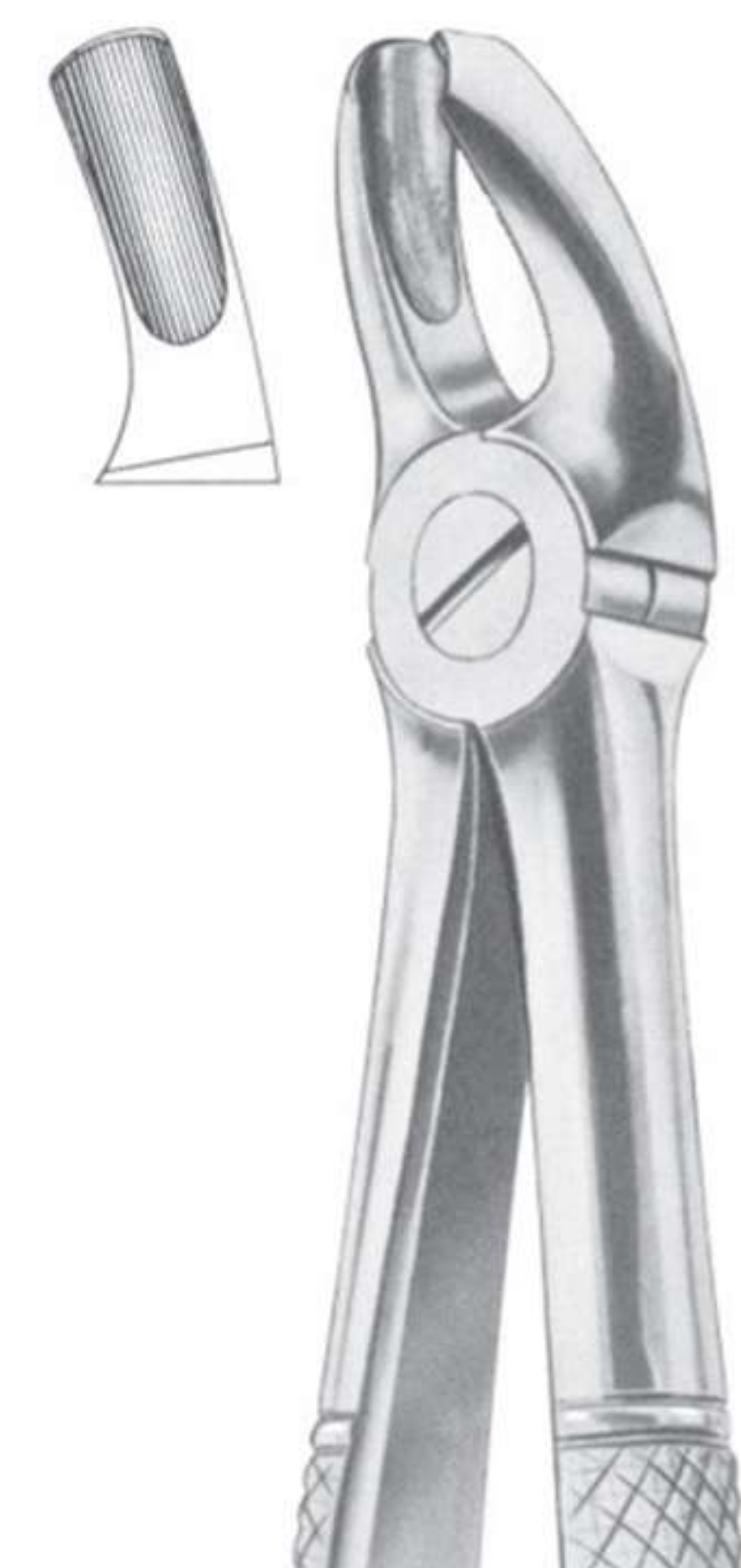

DMI-2-1012
Fig. 18 upper molars, left

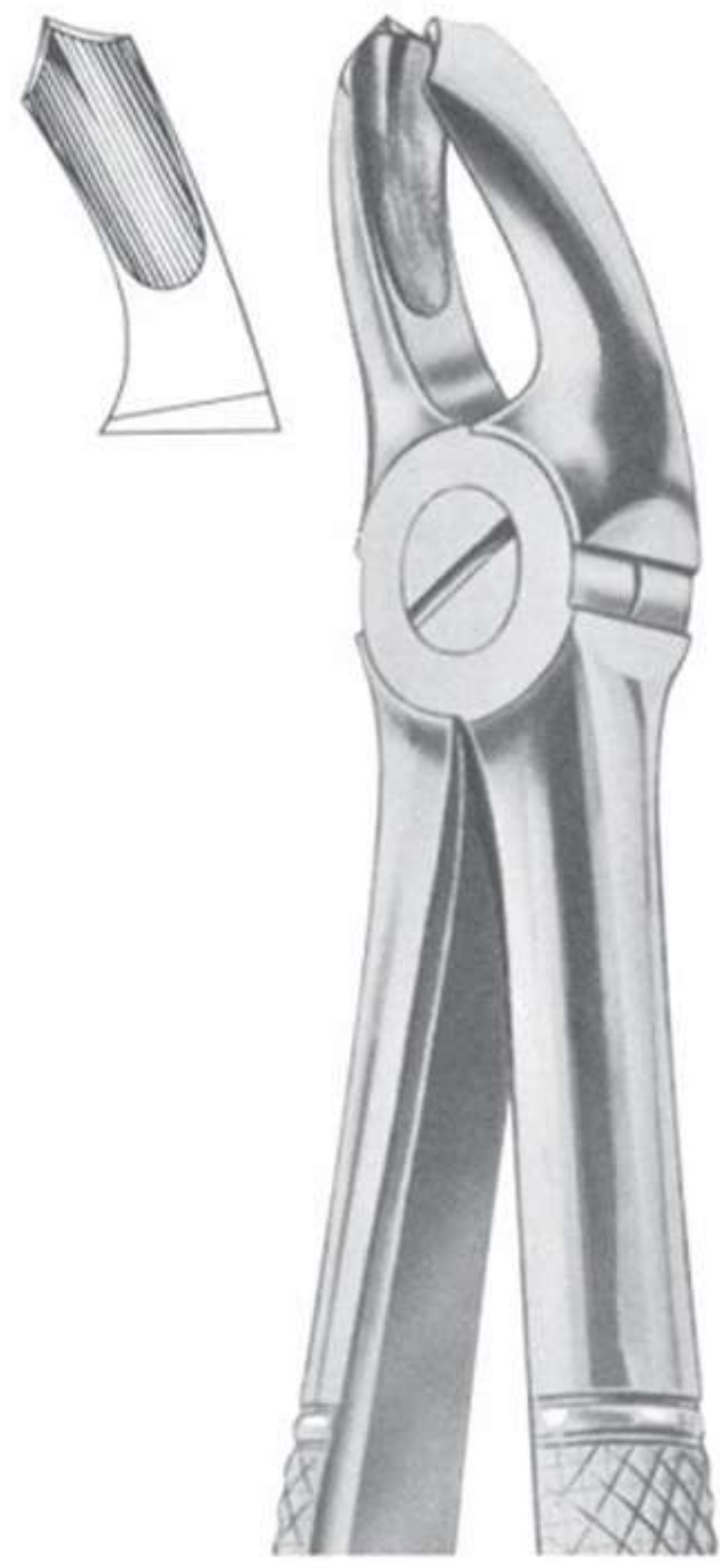

DMI-2-1013
Fig. 18A upper molars

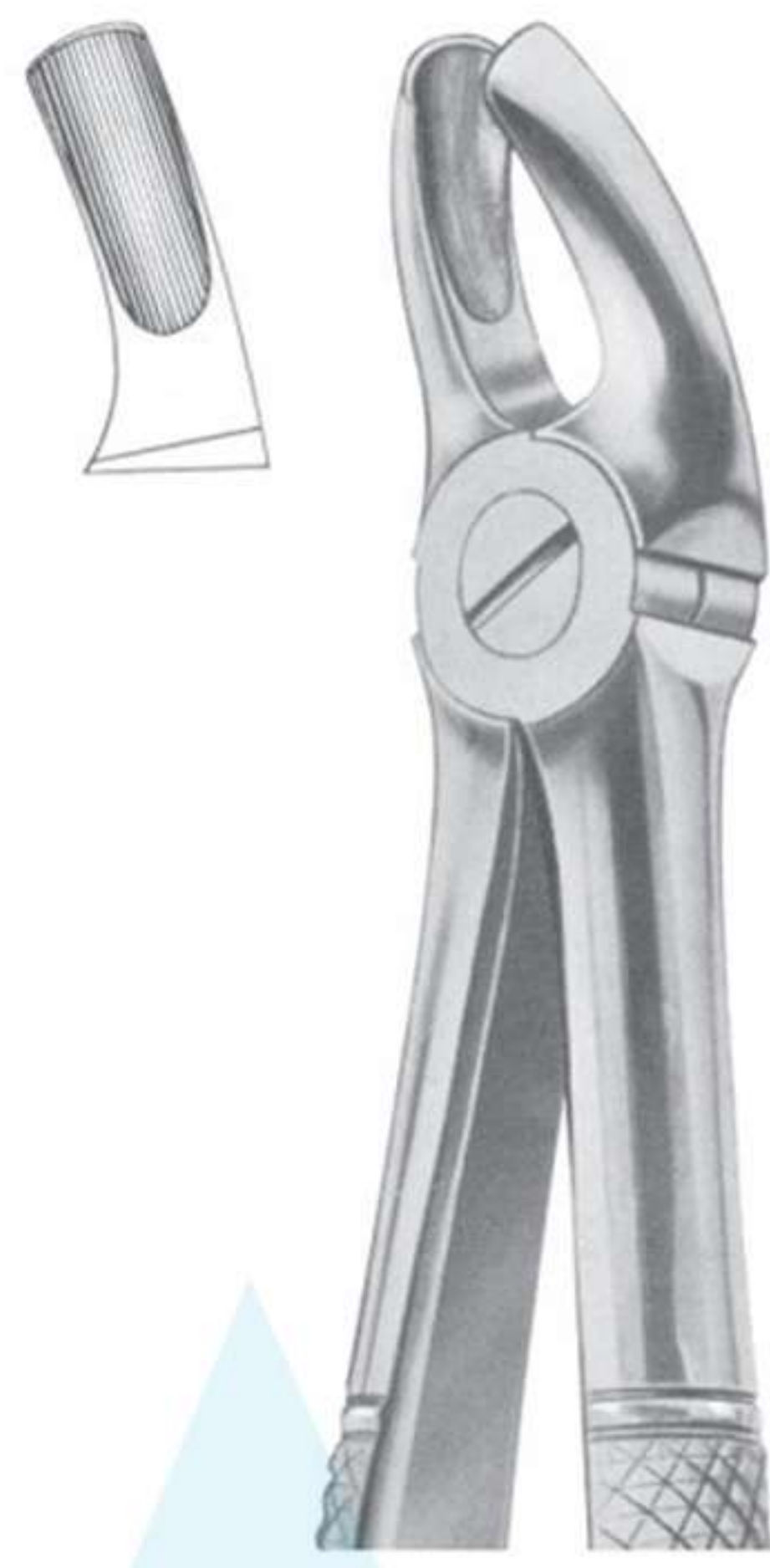

DMI-2-1014
Fig. 18B upper molars



DMI-2-1015
Fig. 19 upper third molars



DMI-2-1016
Fig. 20 upper third molars

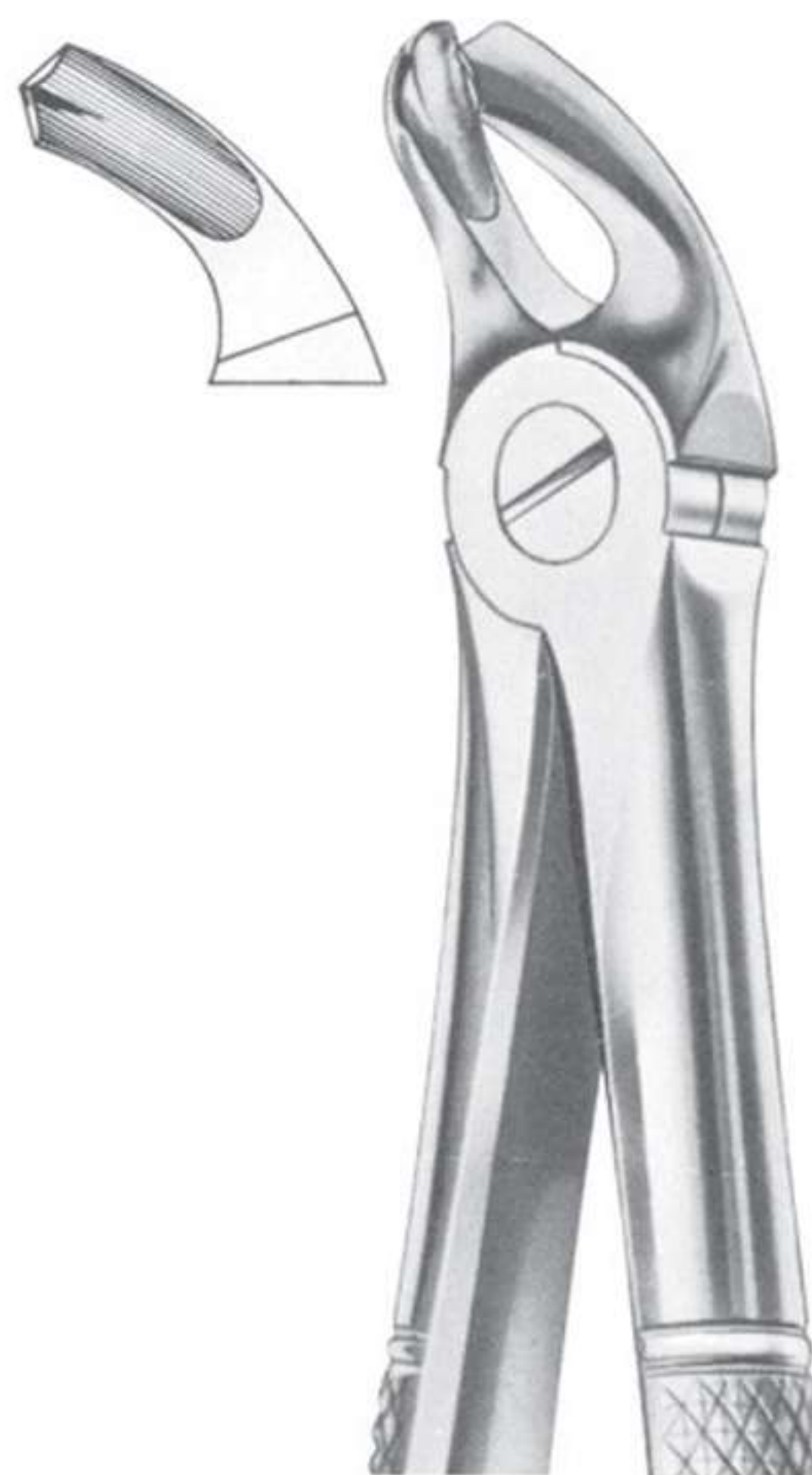

DMI-2-1017
Fig. 21 lower molars

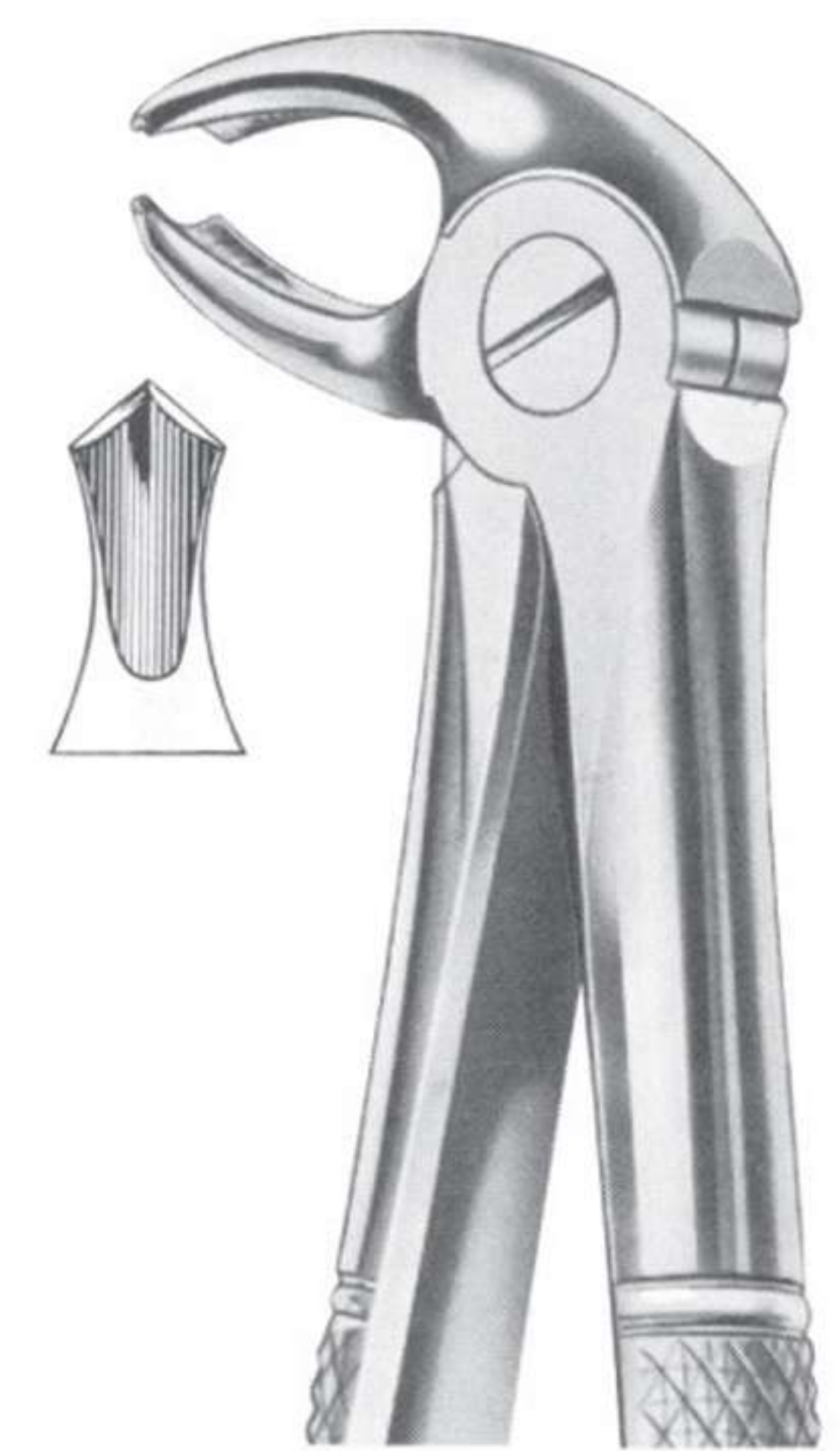

DMI-2-1018
Fig. 22 lower molars

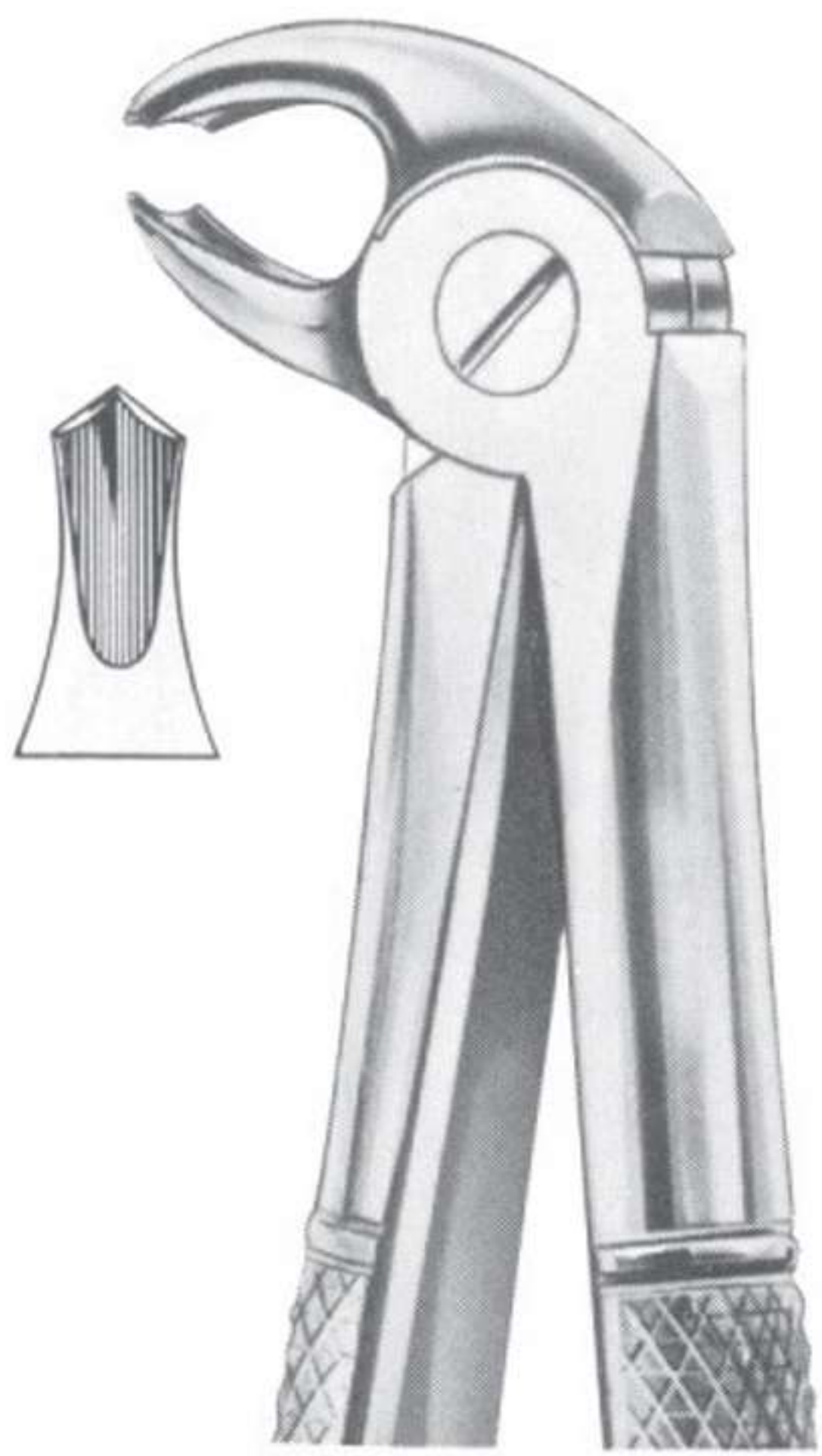

DMI-2-1019
Fig. 22S lower molars
for children

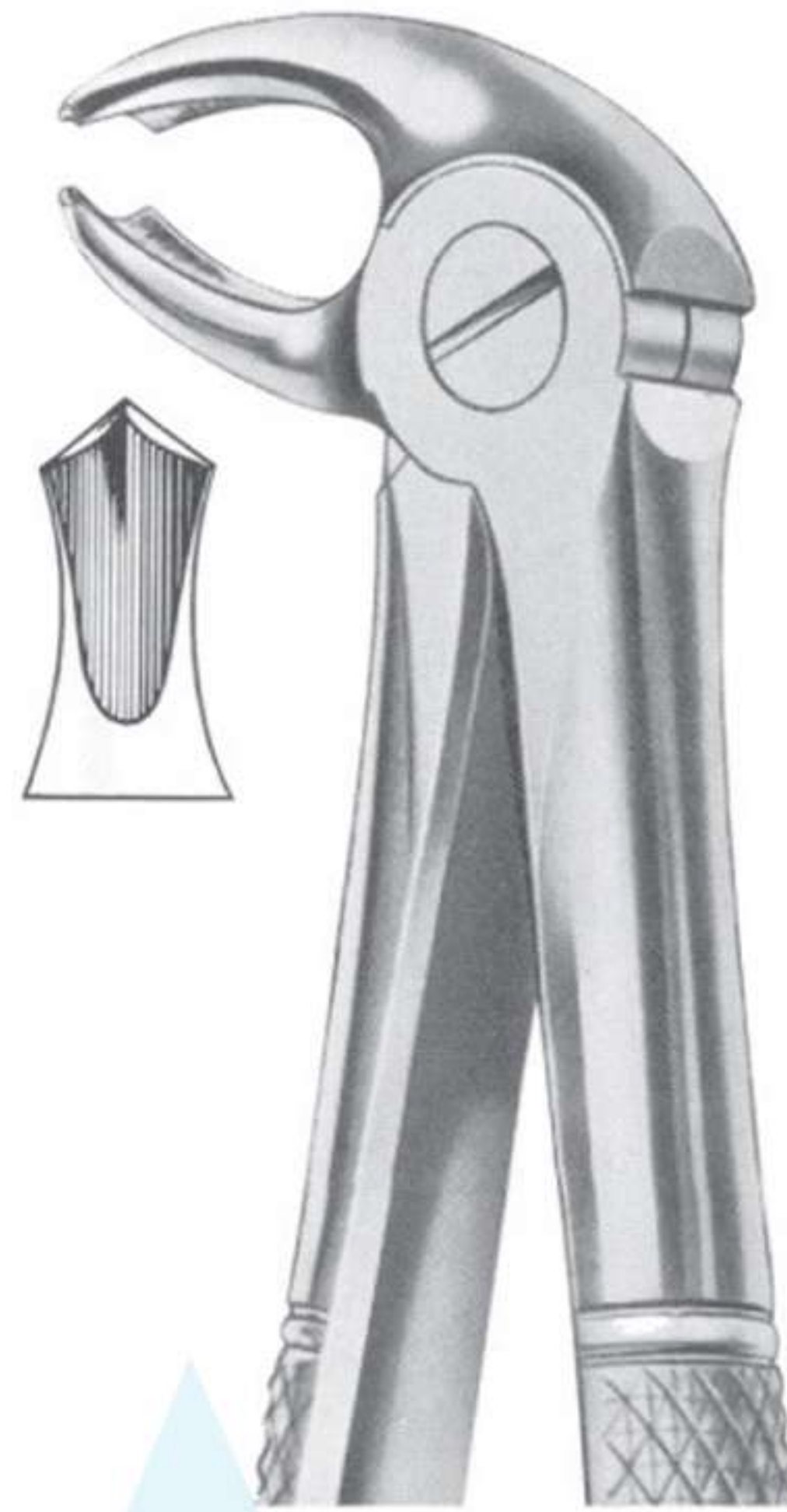

DMI-2-1020
Fig. 22G lower molars

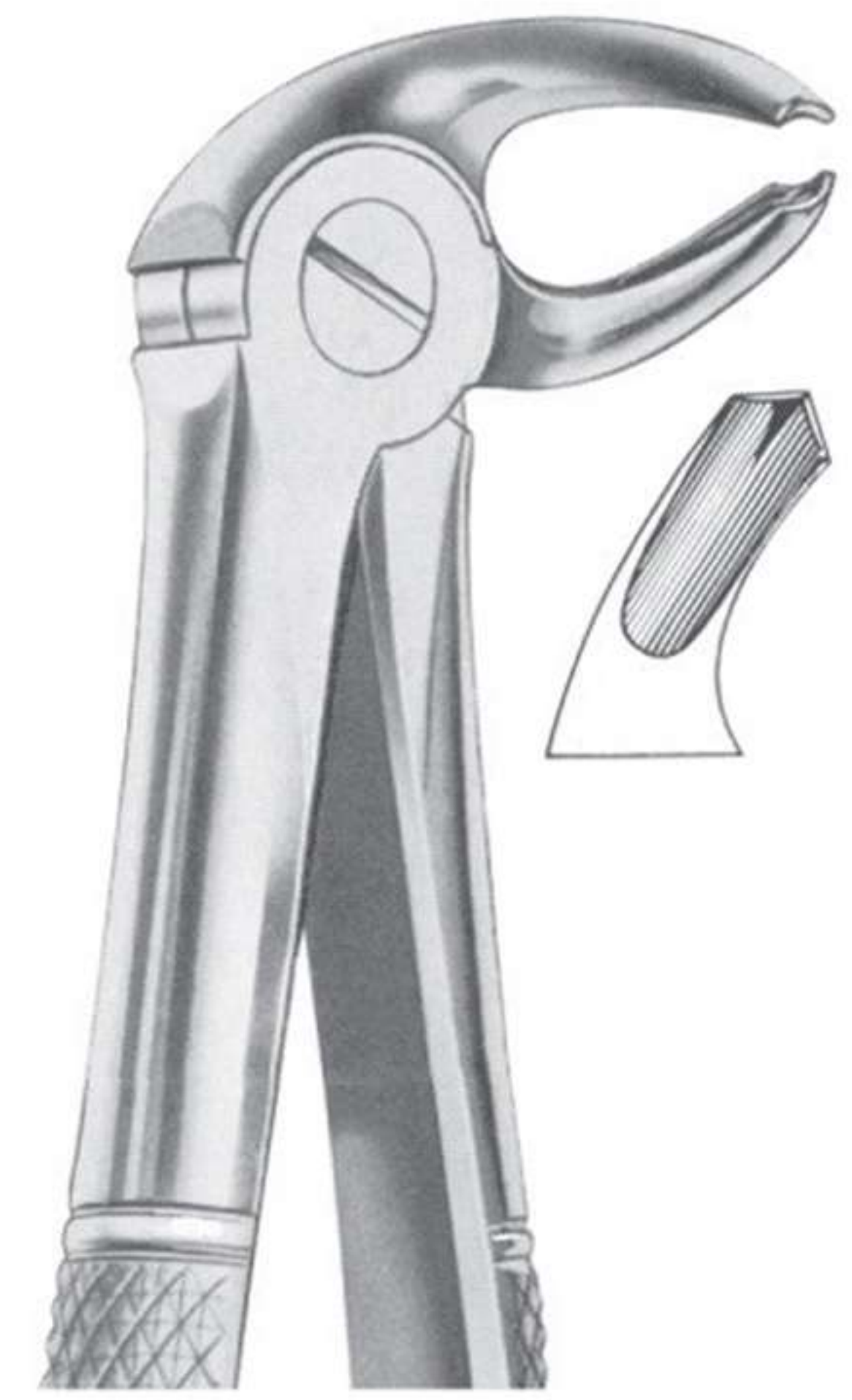

DMI-2-1021
Fig. 23 lower molars right

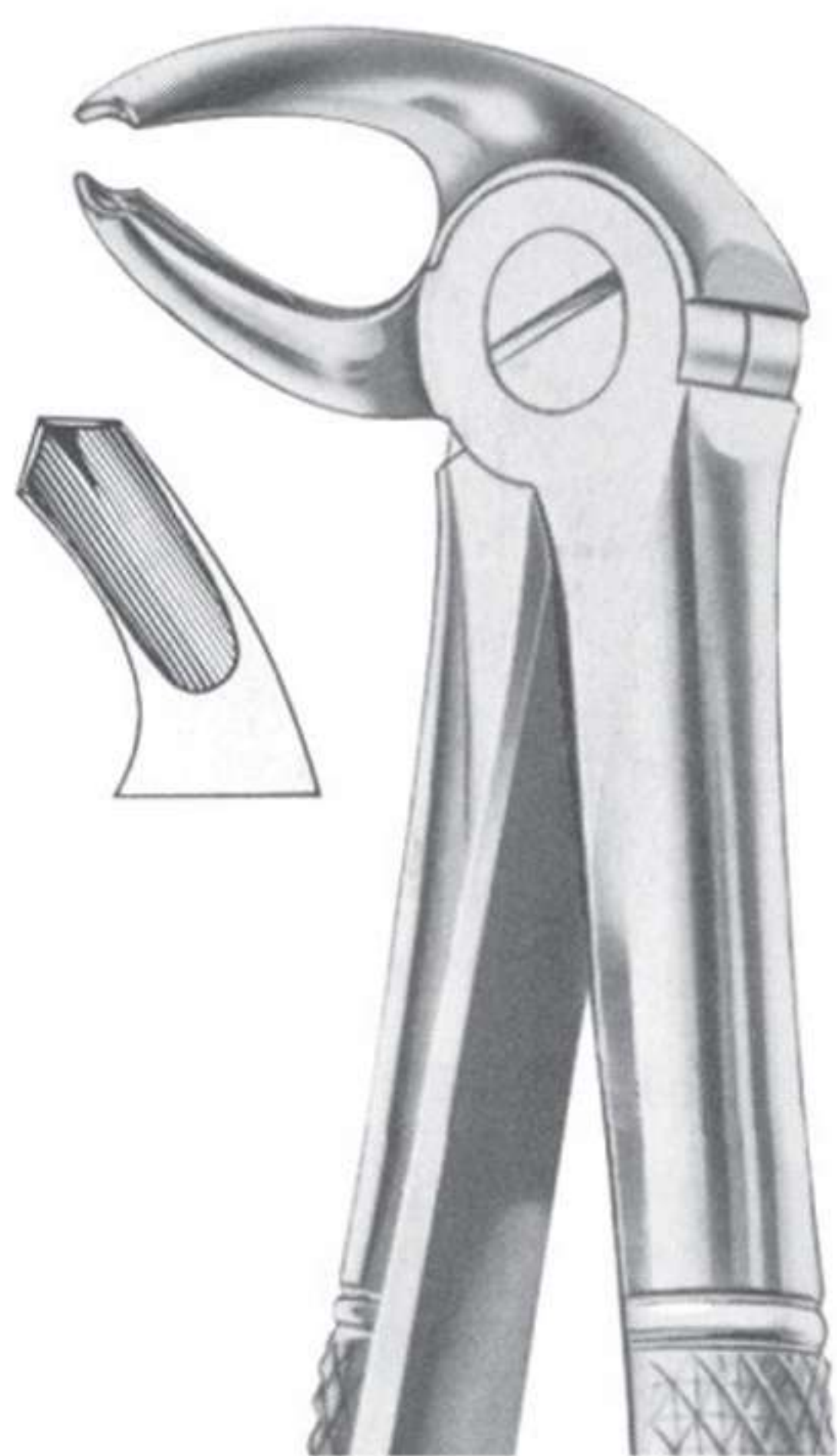

DMI-2-1022
Fig. 24 lower molars left



DMI-2-1023
Fig. 29 upper roots

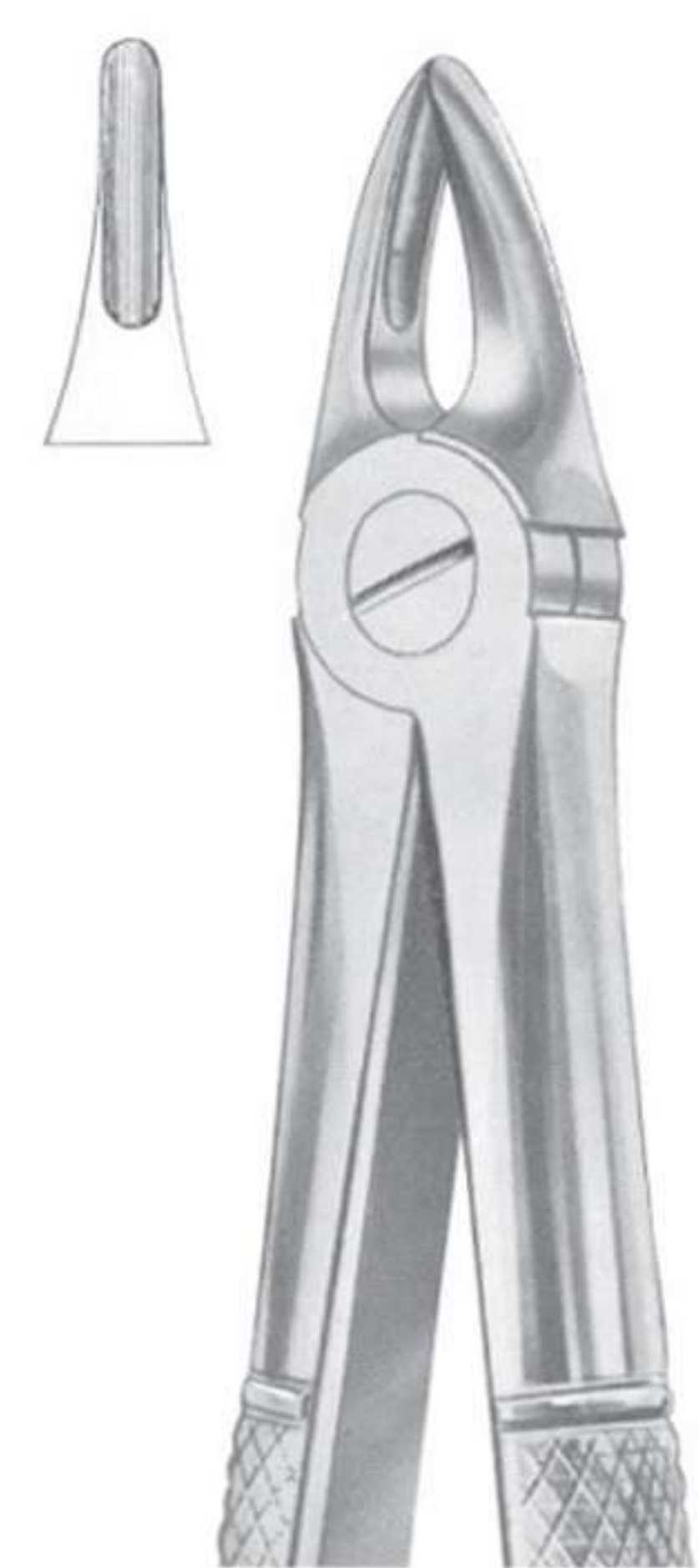

DMI-2-1024
Fig. 29S upper roots
for children

Extracting Forceps



DMI-2-1025
Fig. 30 upper roots

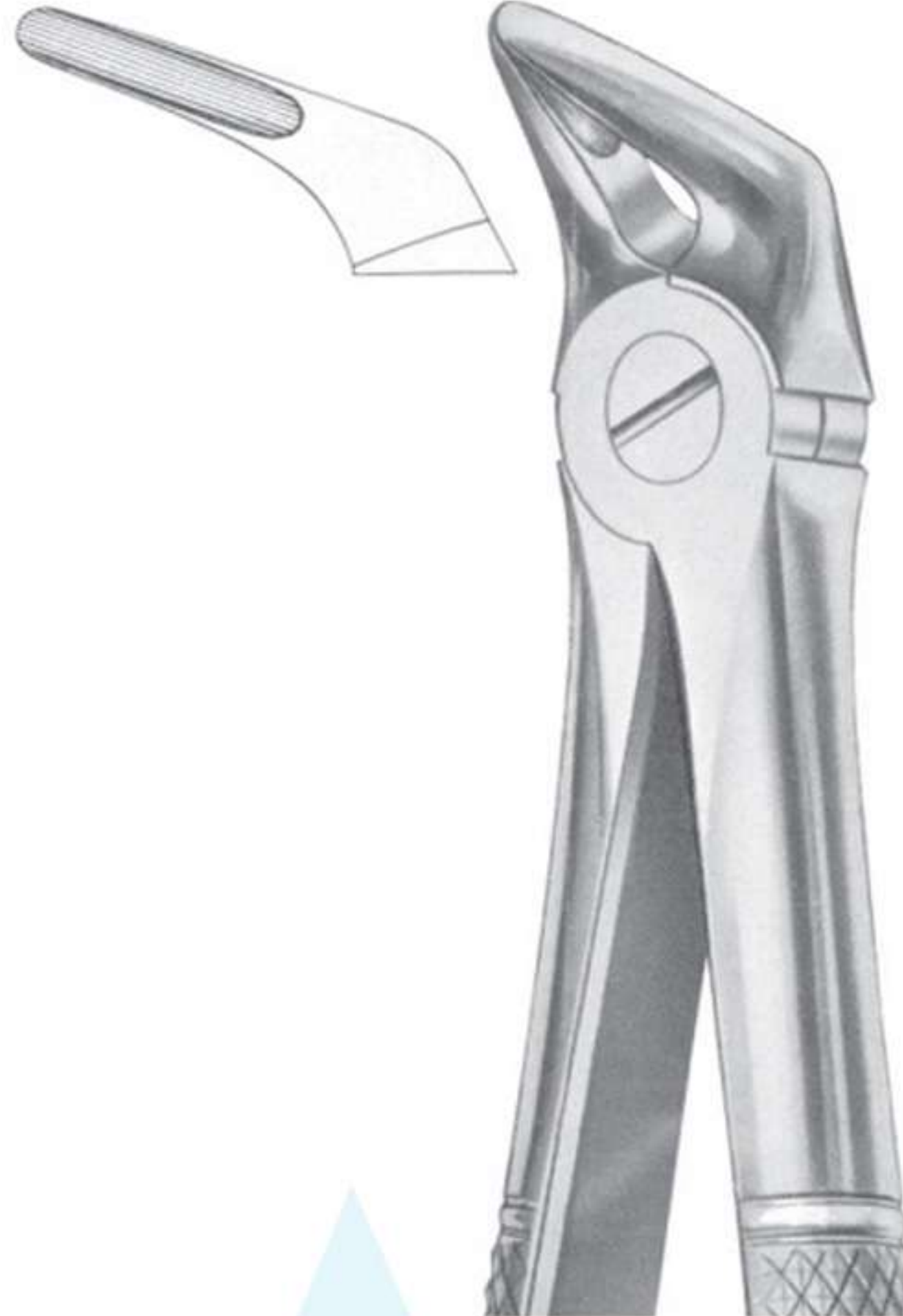

DMI-2-1026
Fig. 31 lower roots



DMI-2-1027
Fig. 32 lower molars



DMI-2-1028
Fig. 30S upper roots
for children



DMI-2-1029
Fig. 33 lower roots

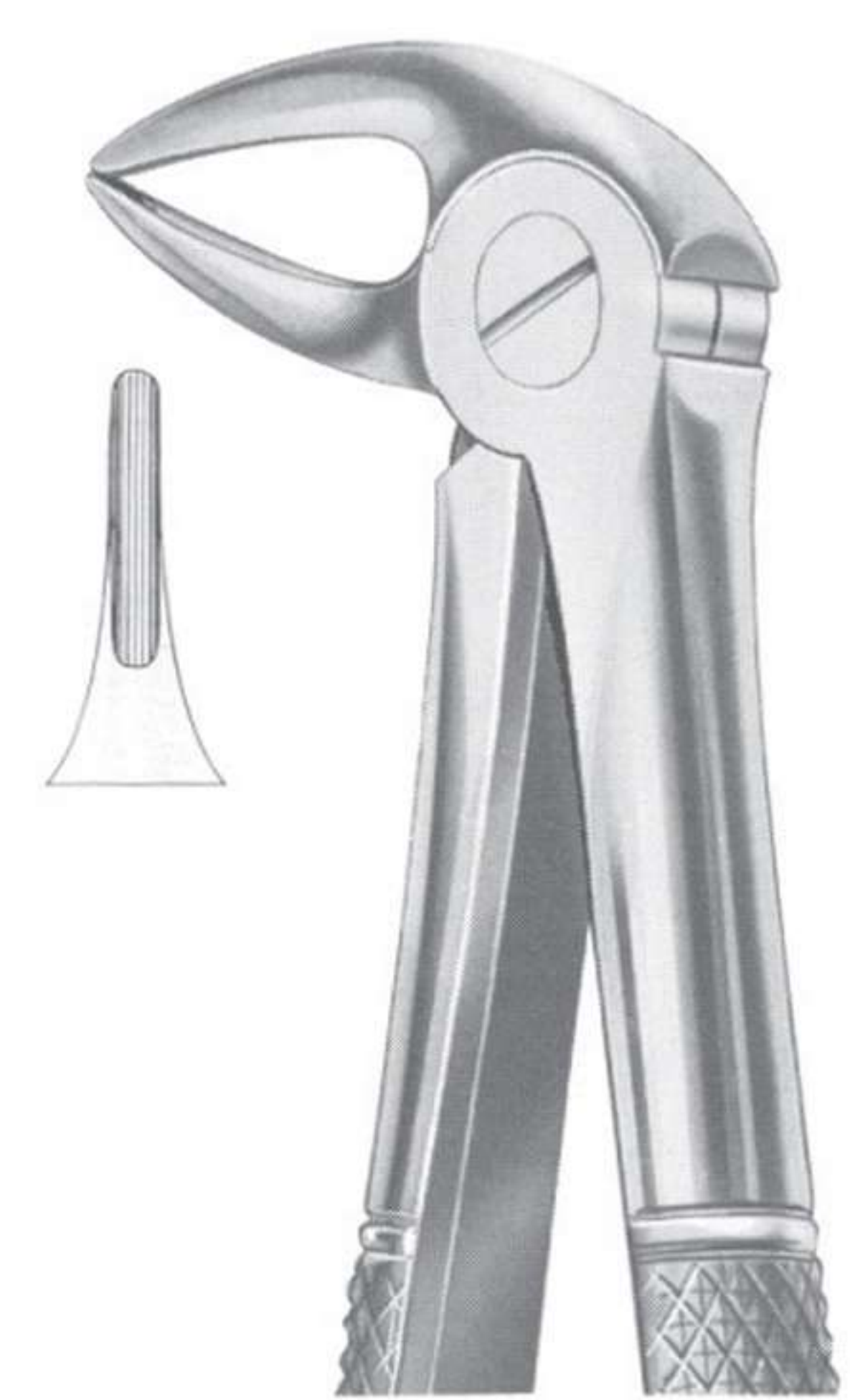

DMI-2-1030
Fig. 33A lower roots



DMI-2-1031
Fig. 33B lower roots



DMI-2-1032
Fig. 33L lower roots



DMI-2-1033
Fig. 37 upper incisors
for children



DMI-2-1034
Fig. 33S lower roots
for children



DMI-2-1035
Fig. 38 lower incisors & canines
for children

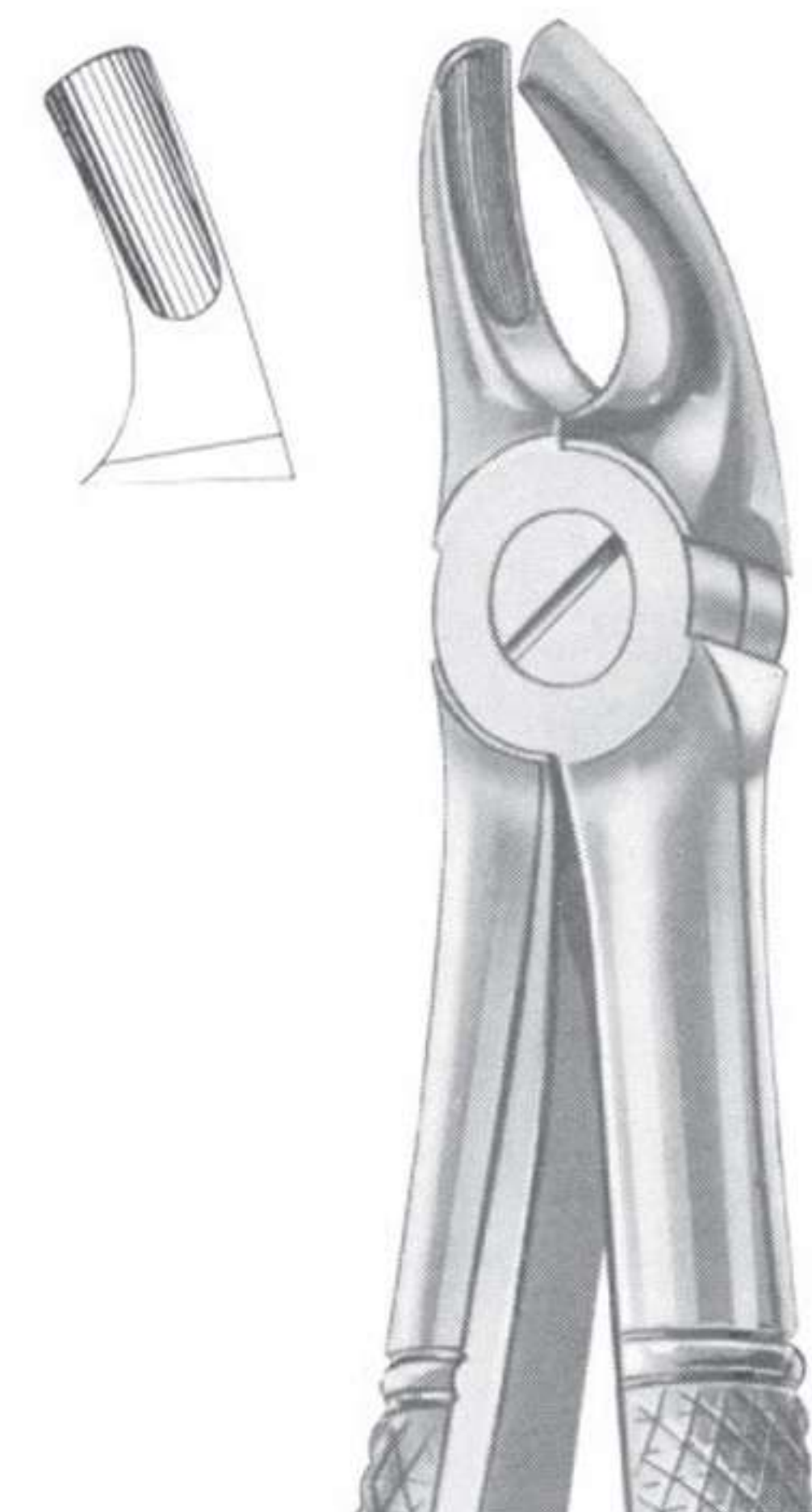

DMI-2-1036
Fig. 39 upper molars
for children

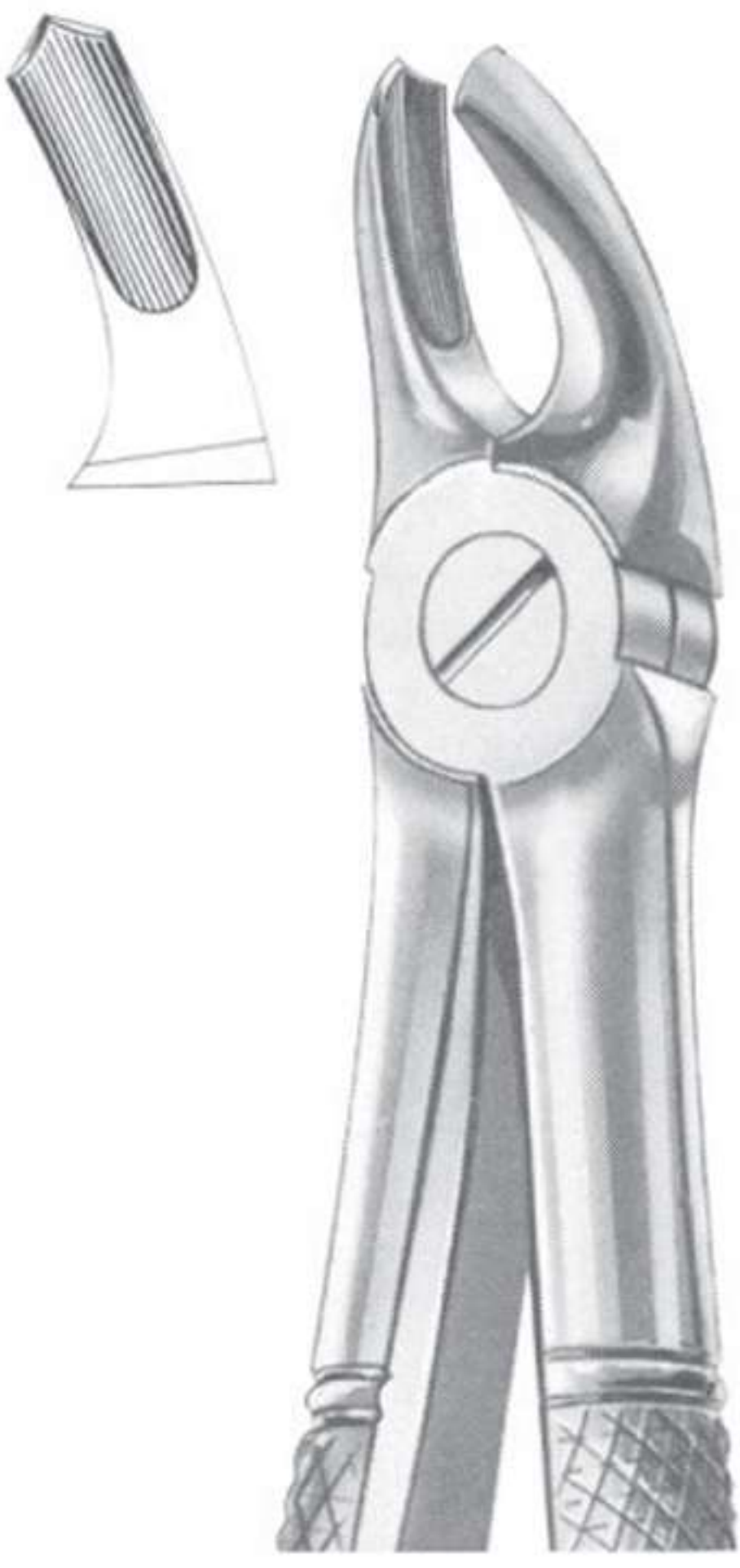

DMI-2-1037
Fig. 39R upper molars right
for children

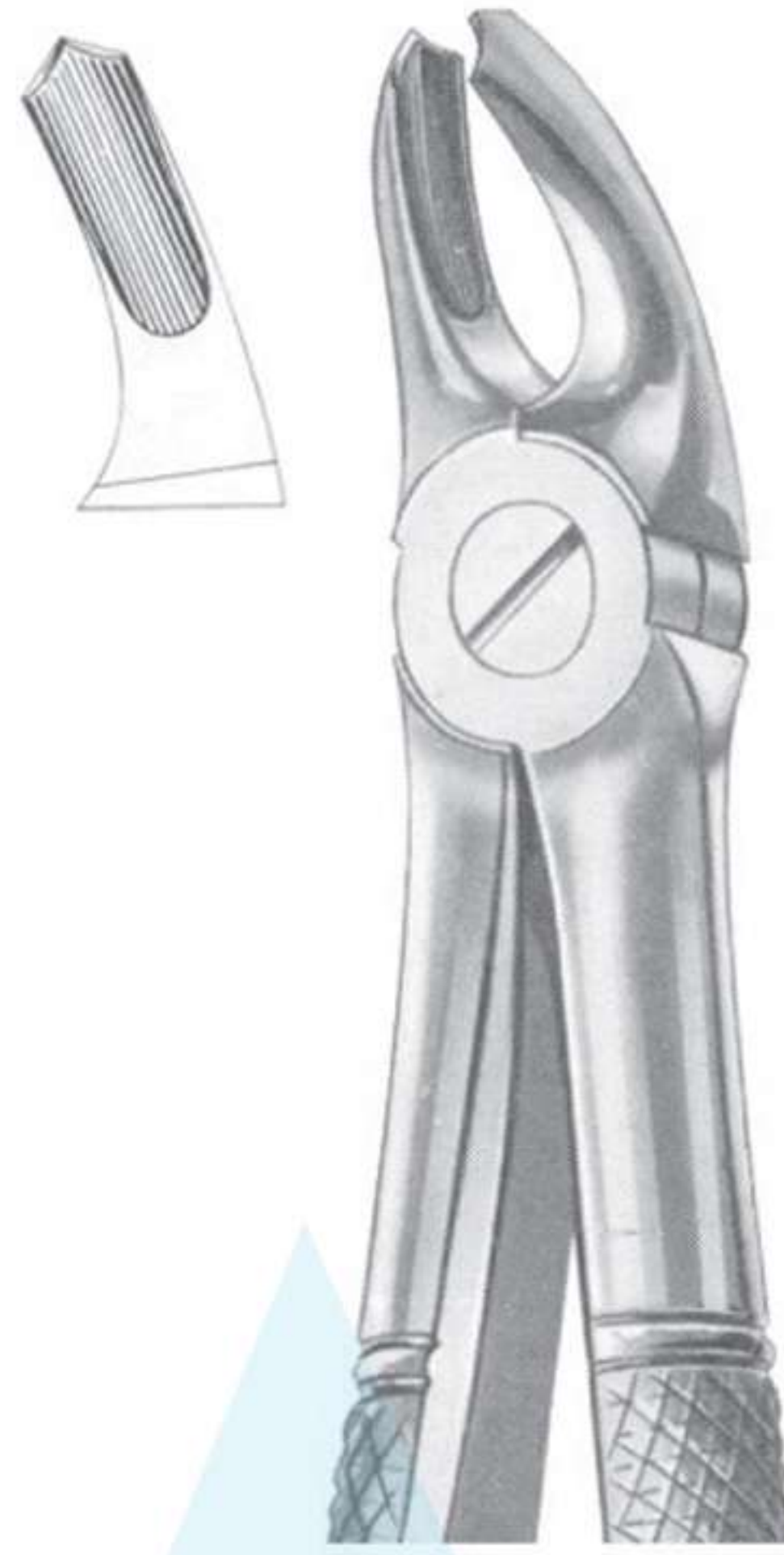

DMI-2-1038
Fig. 39A upper molars
for children

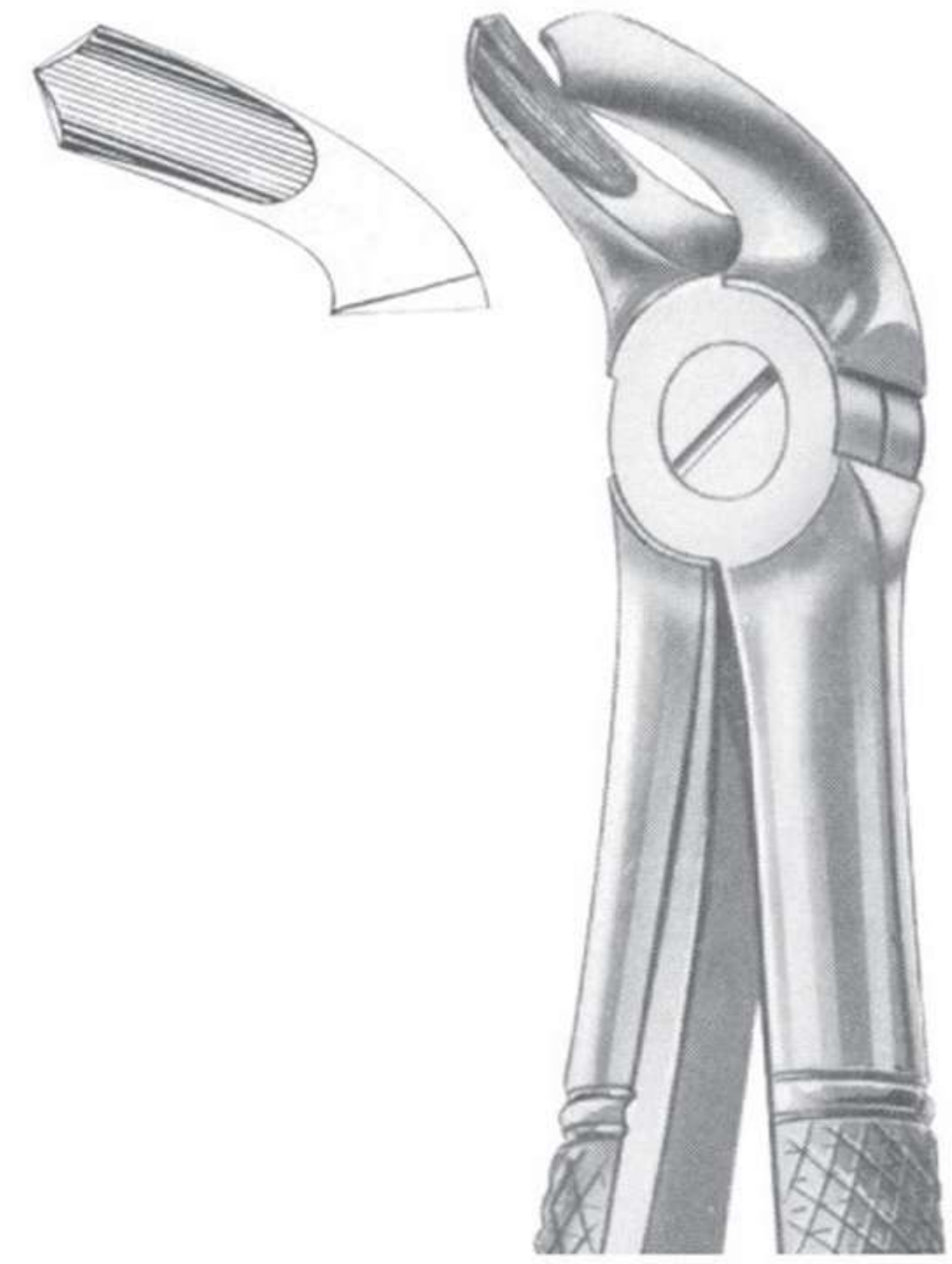

DMI-2-1039
Fig. 40 lower molars
for children



DMI-2-1040
Fig. 39L upper molars left
for children



DMI-2-1041
Fig. 41 upper roots



DMI-2-1042
Fig. 44 upper roots



DMI-2-1043
Fig. 45 lower roots

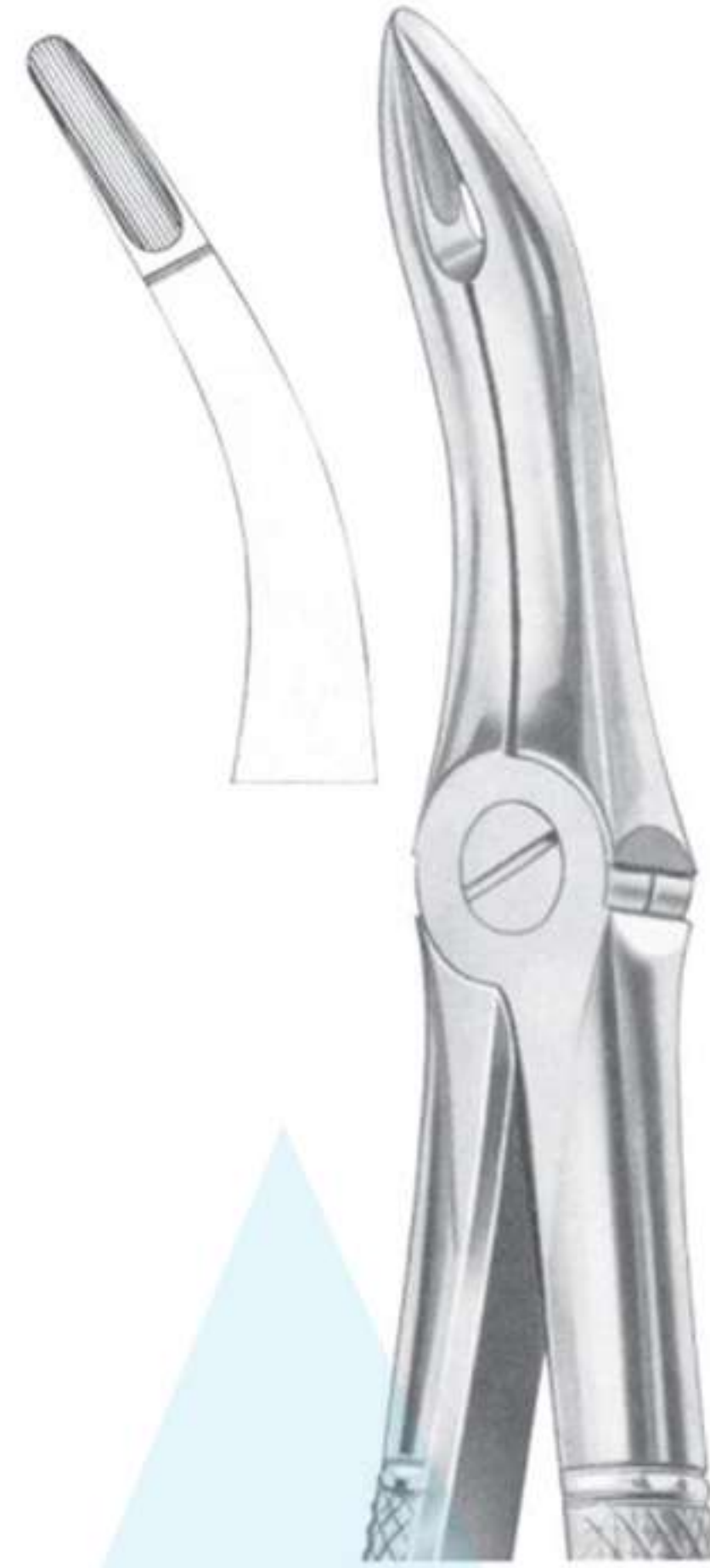

DMI-2-1044
Fig. 48 lower roots

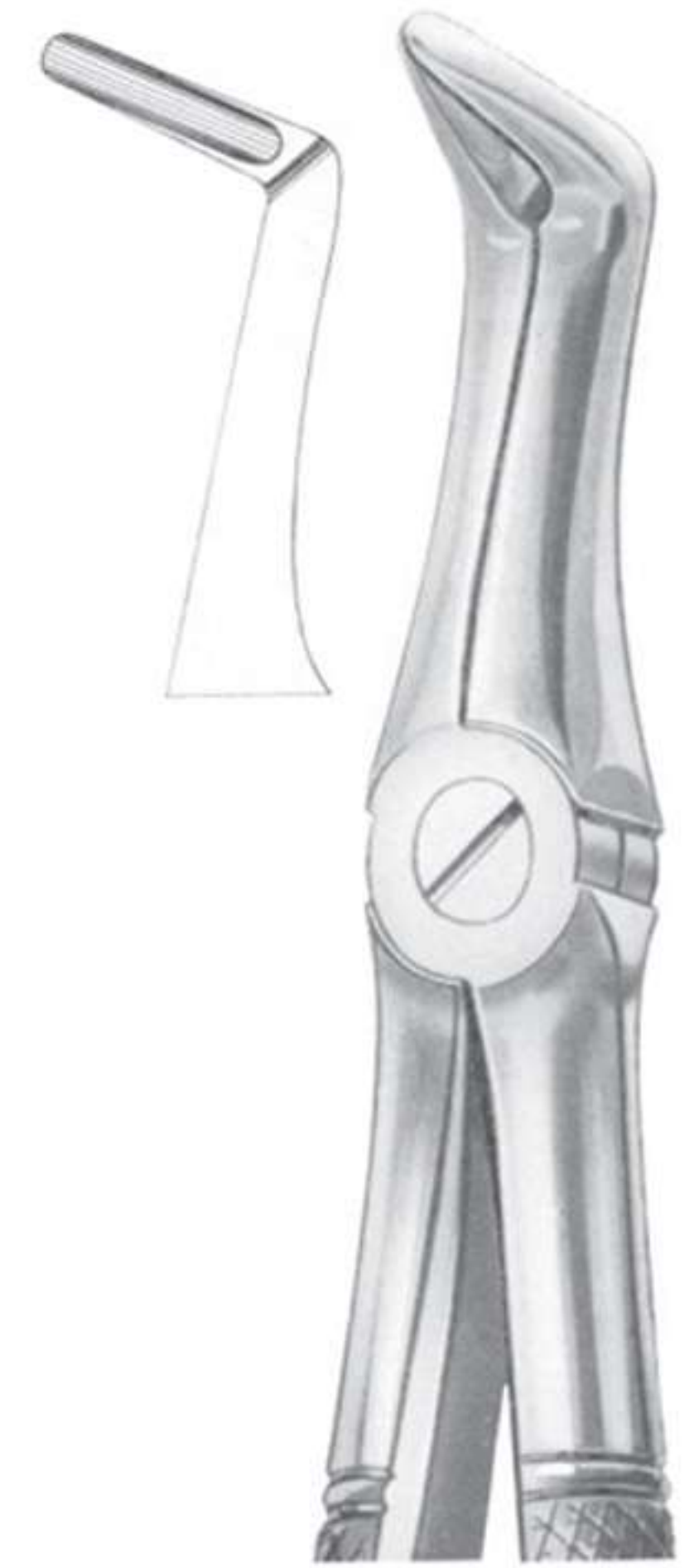

DMI-2-1045
Fig. 49 upper roots



DMI-2-1046
Fig. 50 upper roots



DMI-2-1047
Fig. 51 upper roots



DMI-2-1048
Fig. 51A upper roots



DMI-2-1049
Fig. 51L upper roots



DMI-2-1050
Fig. 52 upper roots



DMI-2-1051
Fig. 52A upper teeth
and resection



DMI-2-1052
Fig. 51S upper roots
for children



DMI-2-1053
Fig. 54 for separating
upper molars



DMI-2-1054
Fig. 55 for separating
upper molars



DMI-2-1055
Fig. 56 for separating
lower molars

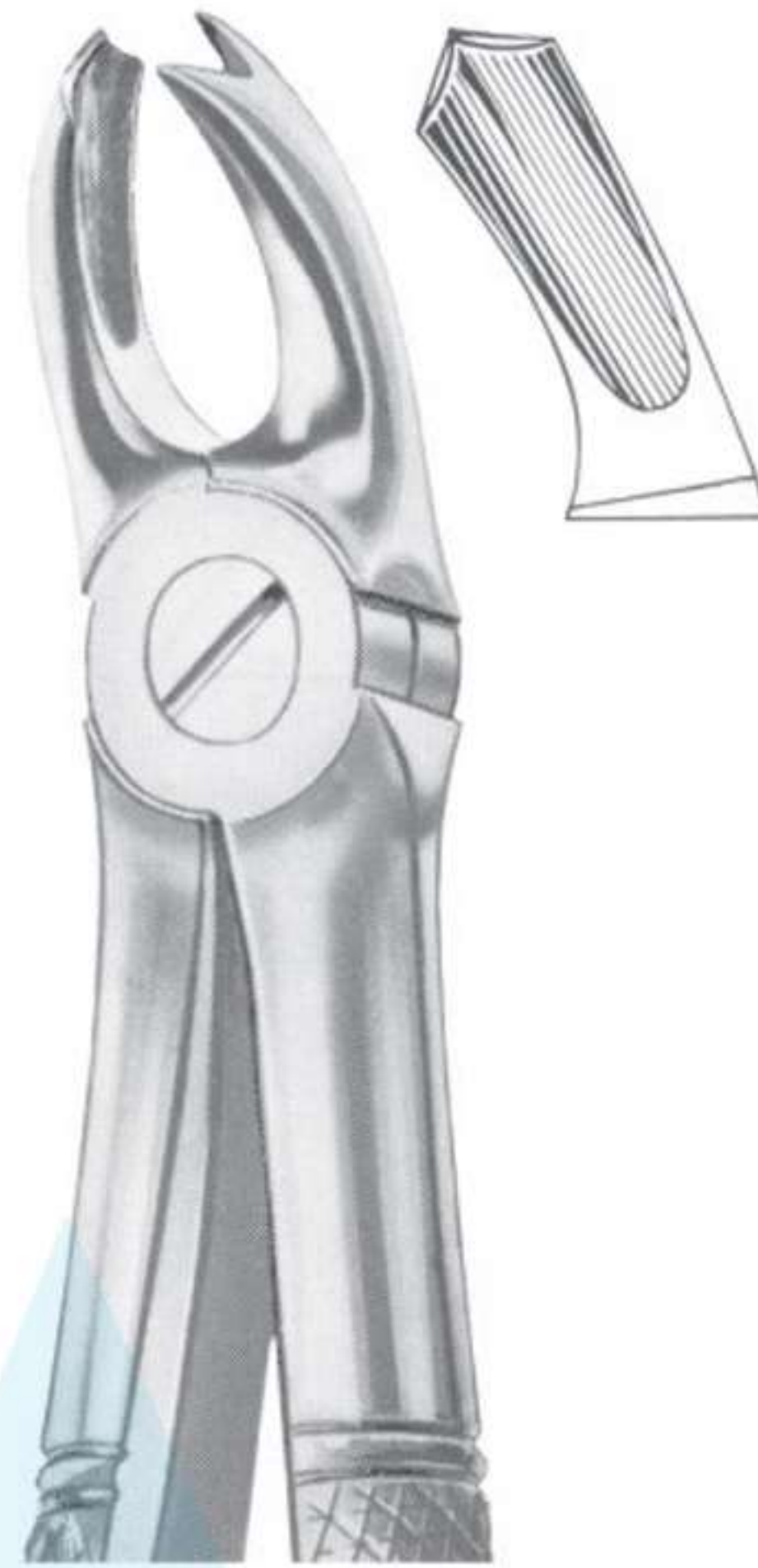

DMI-2-1056
Fig. 65R upper molars right

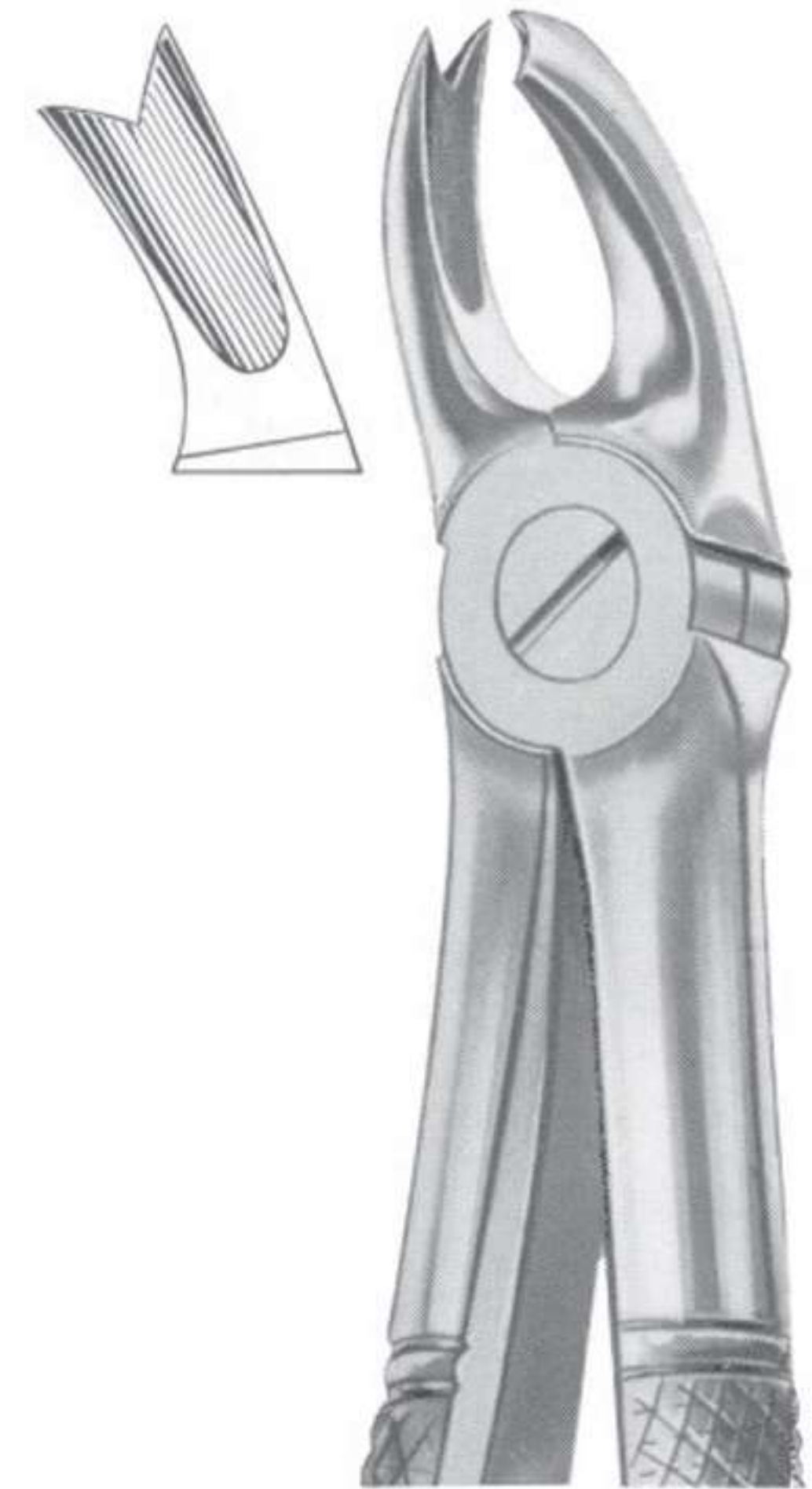

DMI-2-1057
Fig. 65L upper molars left



DMI-2-1058
Fig. 67 upper third molars



DMI-2-1059
Fig. 67A upper third molars



DMI-2-1060
Fig. 67 1/2R upper third
molars right



DMI-2-1061
Fig. 67 ½L upper third
molars left



DMI-2-1062
Fig. 68 lower roots



DMI-2-1063
Fig. 68A lower roots

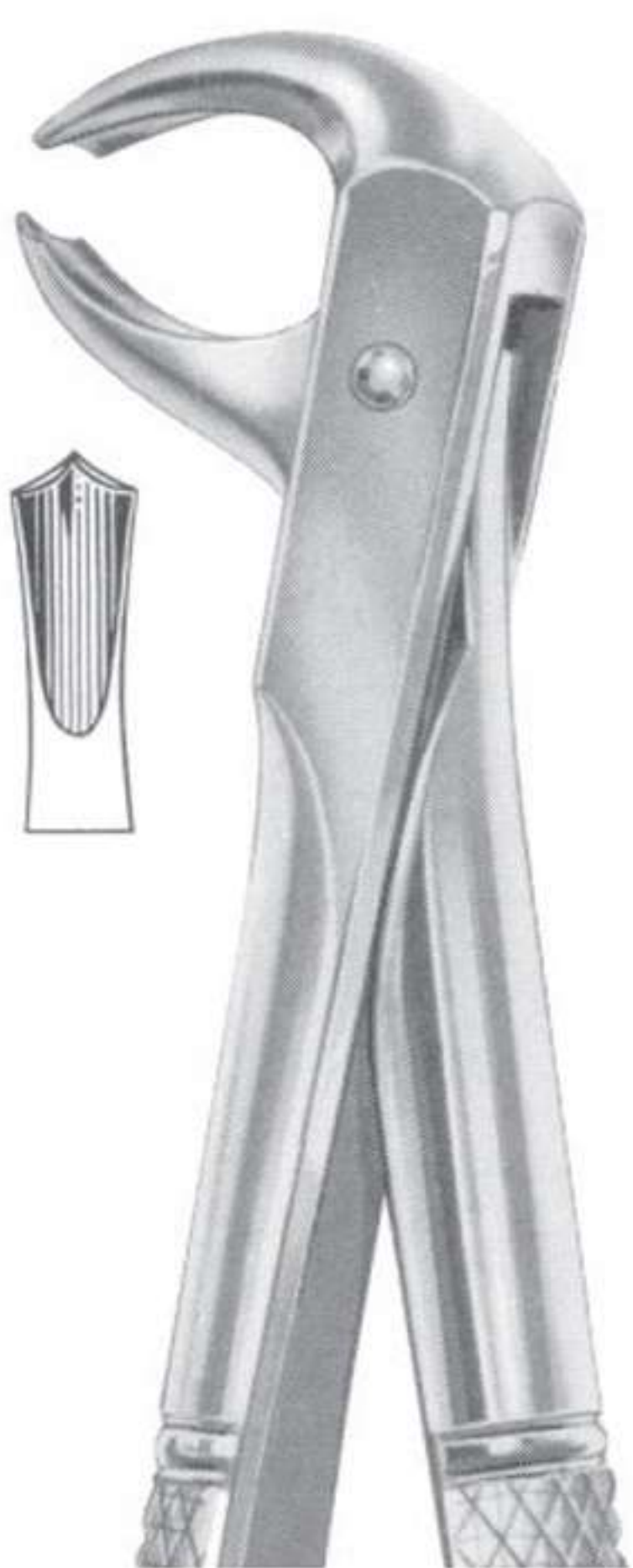

DMI-2-1064
Fig. 73 lower molars



DMI-2-1065
Fig. 73R lower molars right

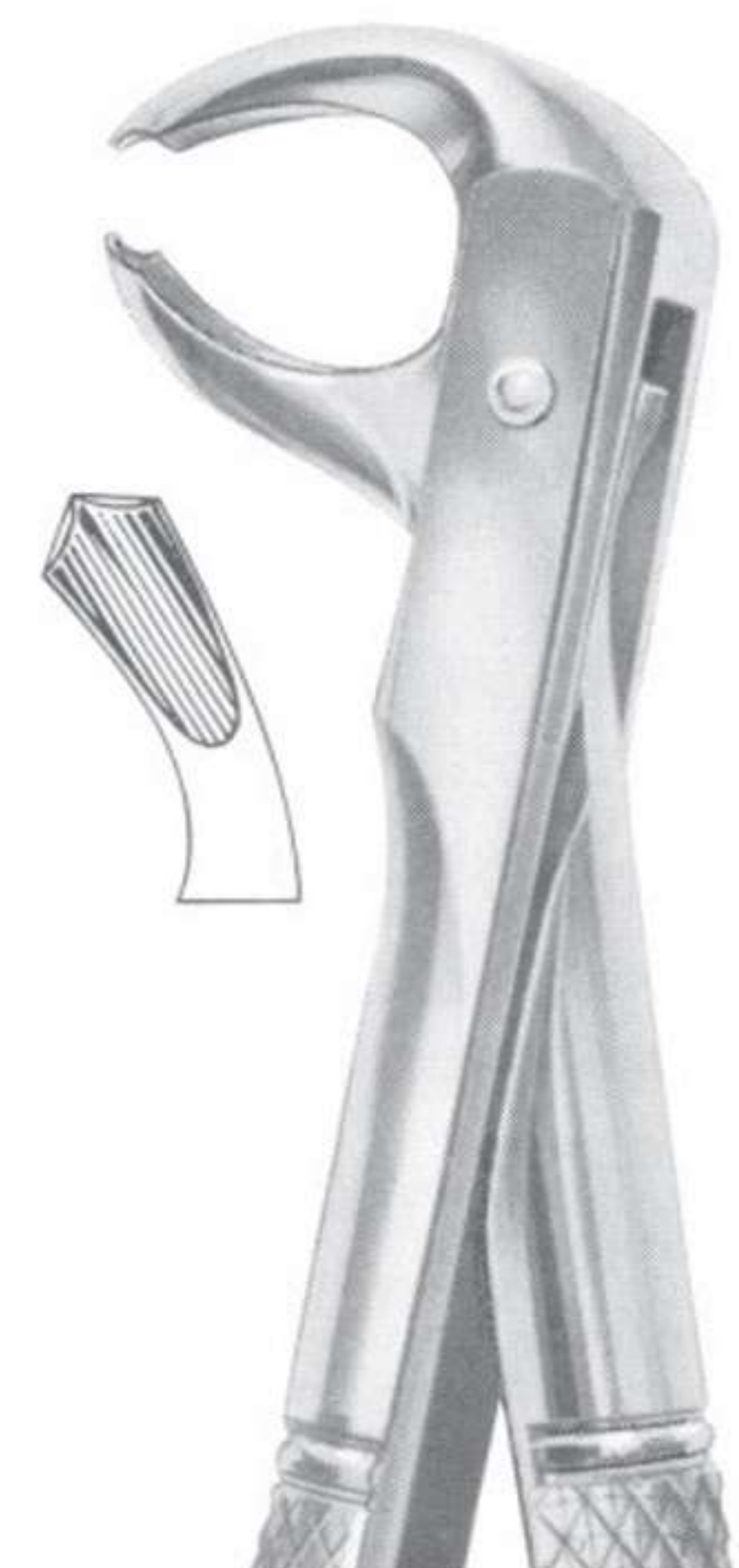

DMI-2-1066
Fig. 73L lower molars left



DMI-2-1067
Fig. 73A lower molars

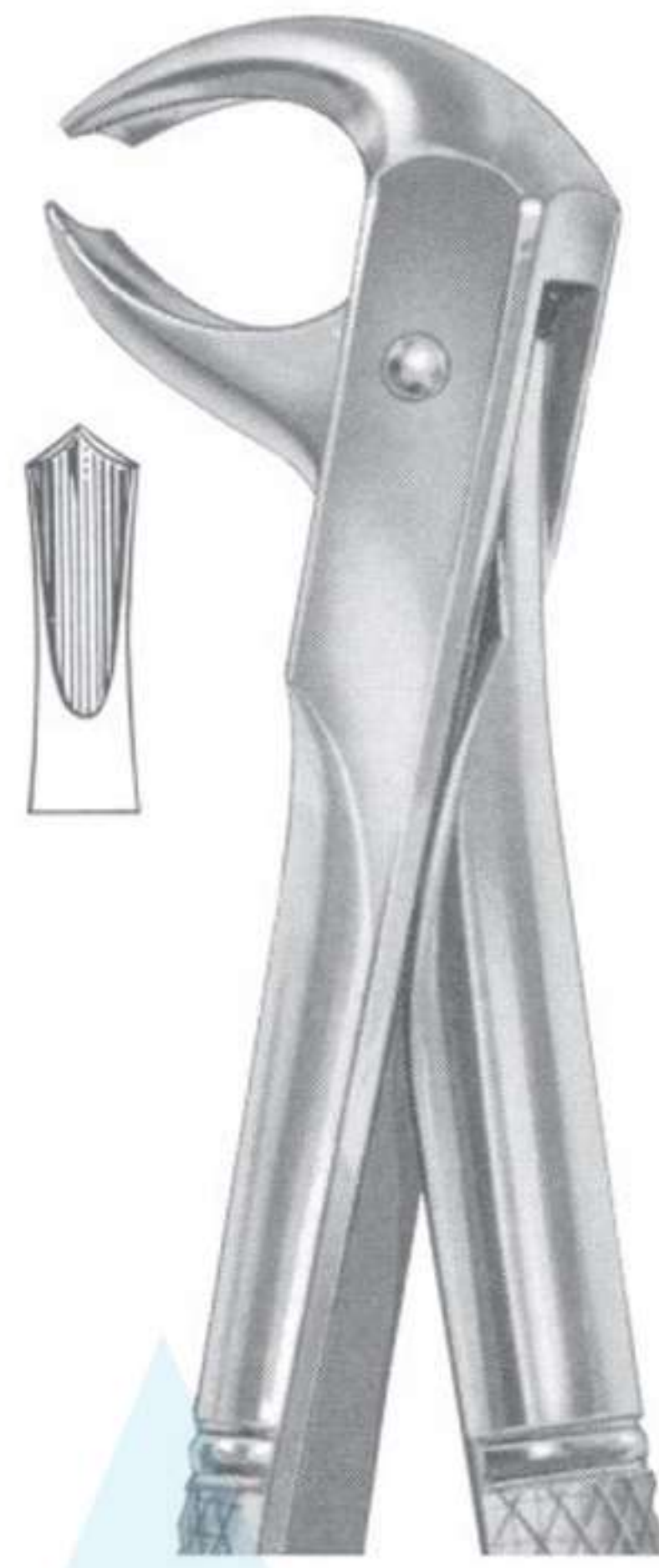

DMI-2-1068
Fig. 73S lower molars

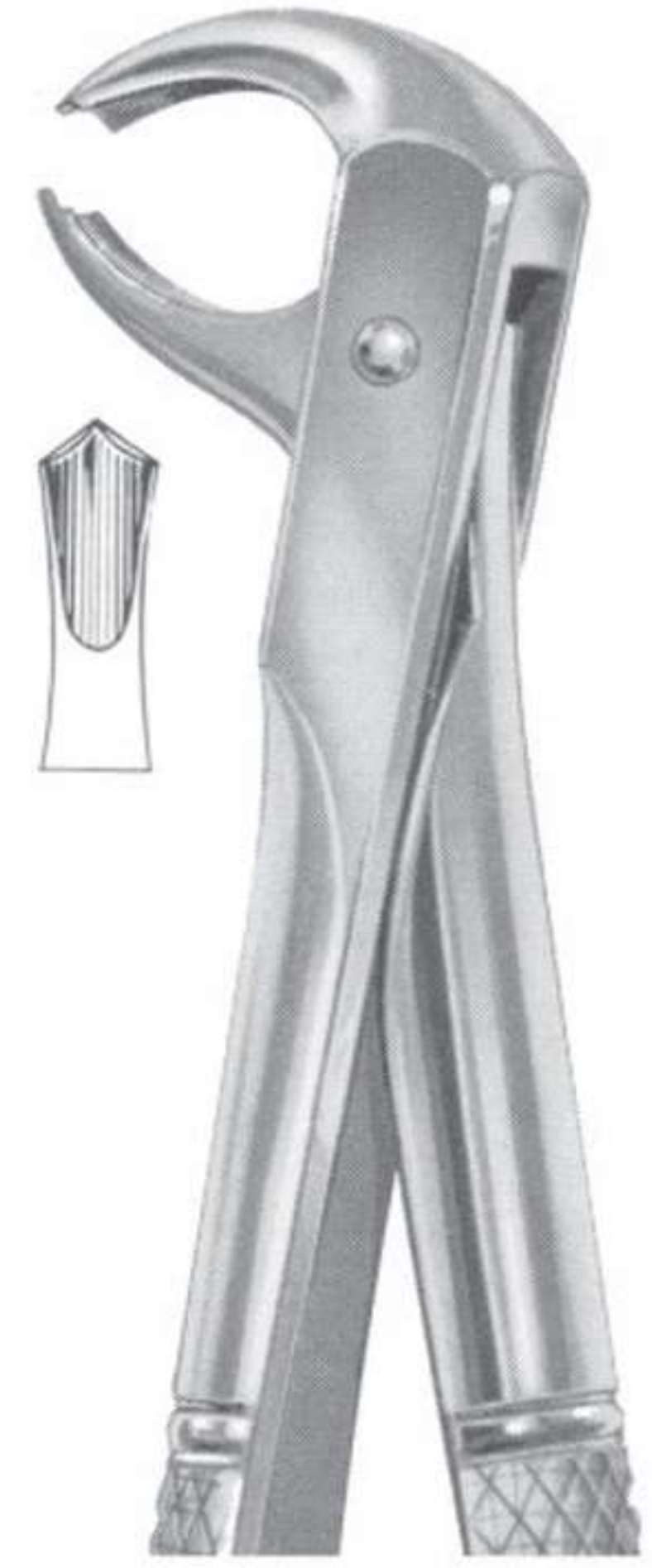

DMI-2-1069
Fig. 73B lower molars
for children

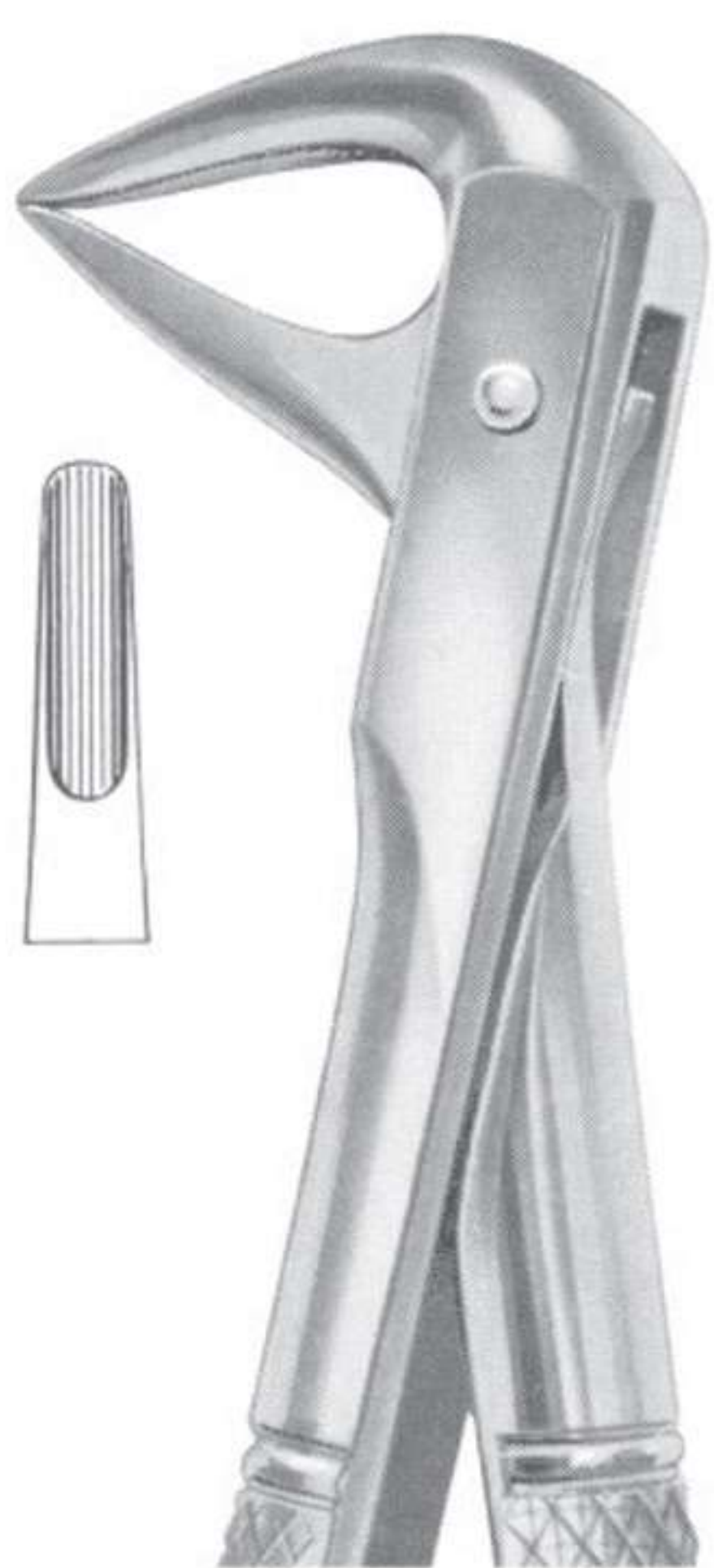

DMI-2-1070
Fig. 74 lower roots

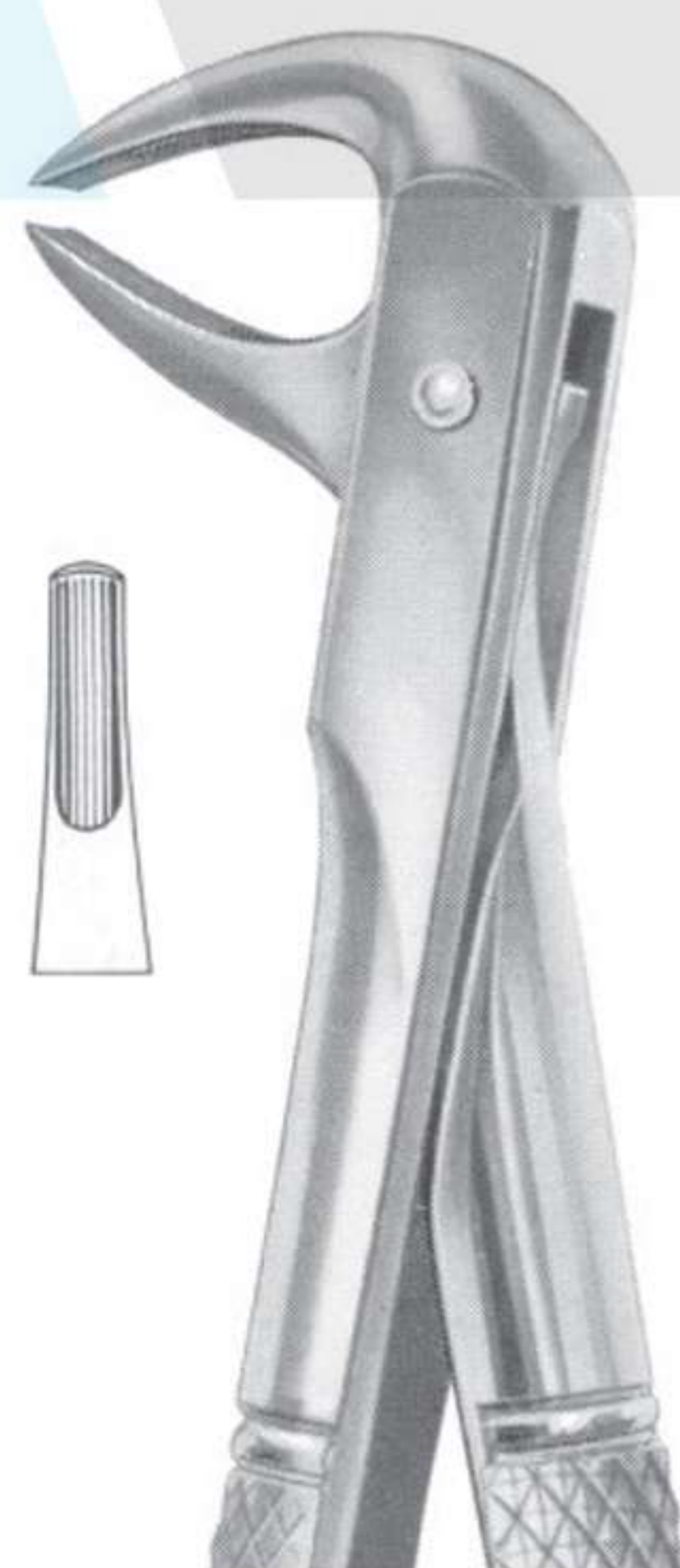

DMI-2-1071
Fig. 74D lower roots



DMI-2-1072
Fig. 73K lower molars
for children



DMI-2-1073
Fig. 73A lower molars

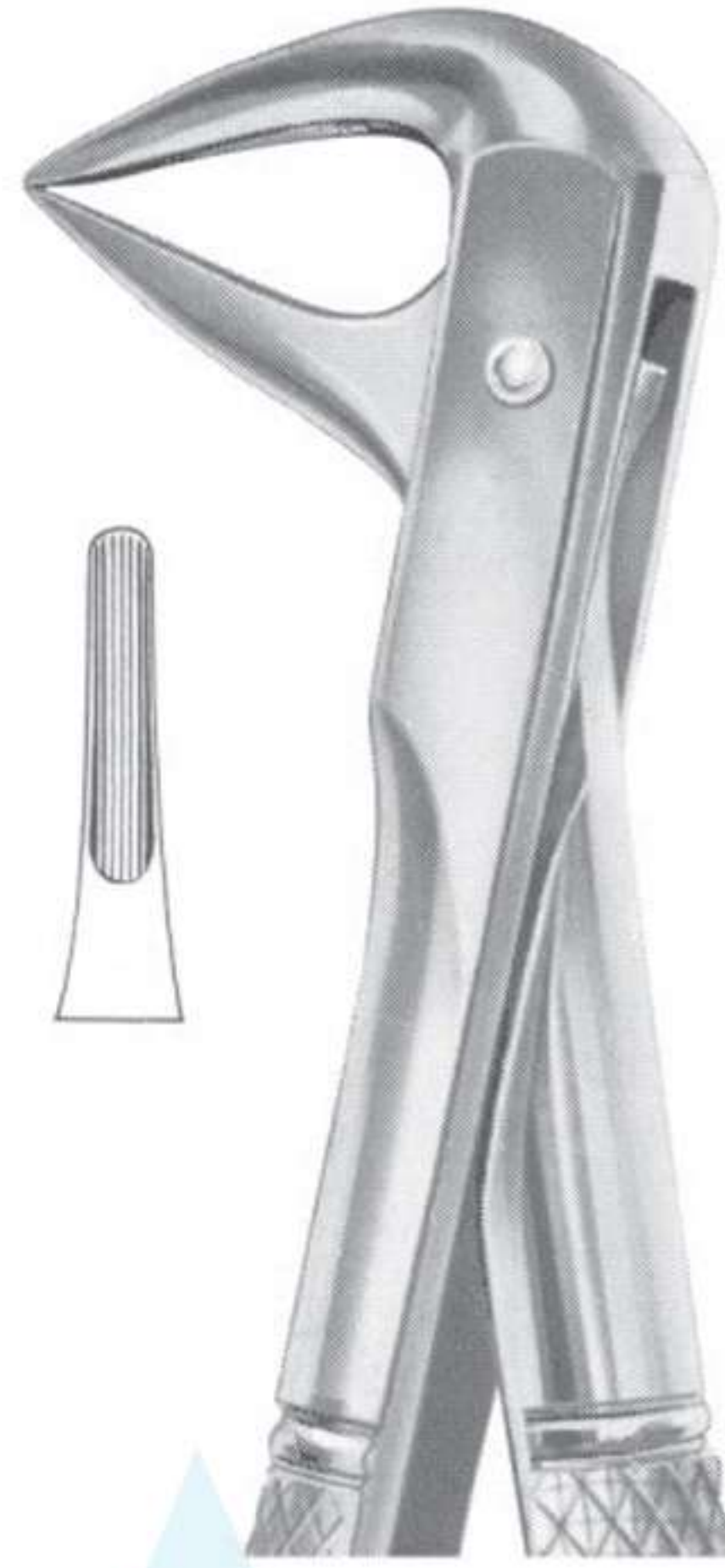

DMIC-2-1074
Fig. 74N lower roots



DMI-2-1075
Fig. 74XN lower roots and crowded incisors

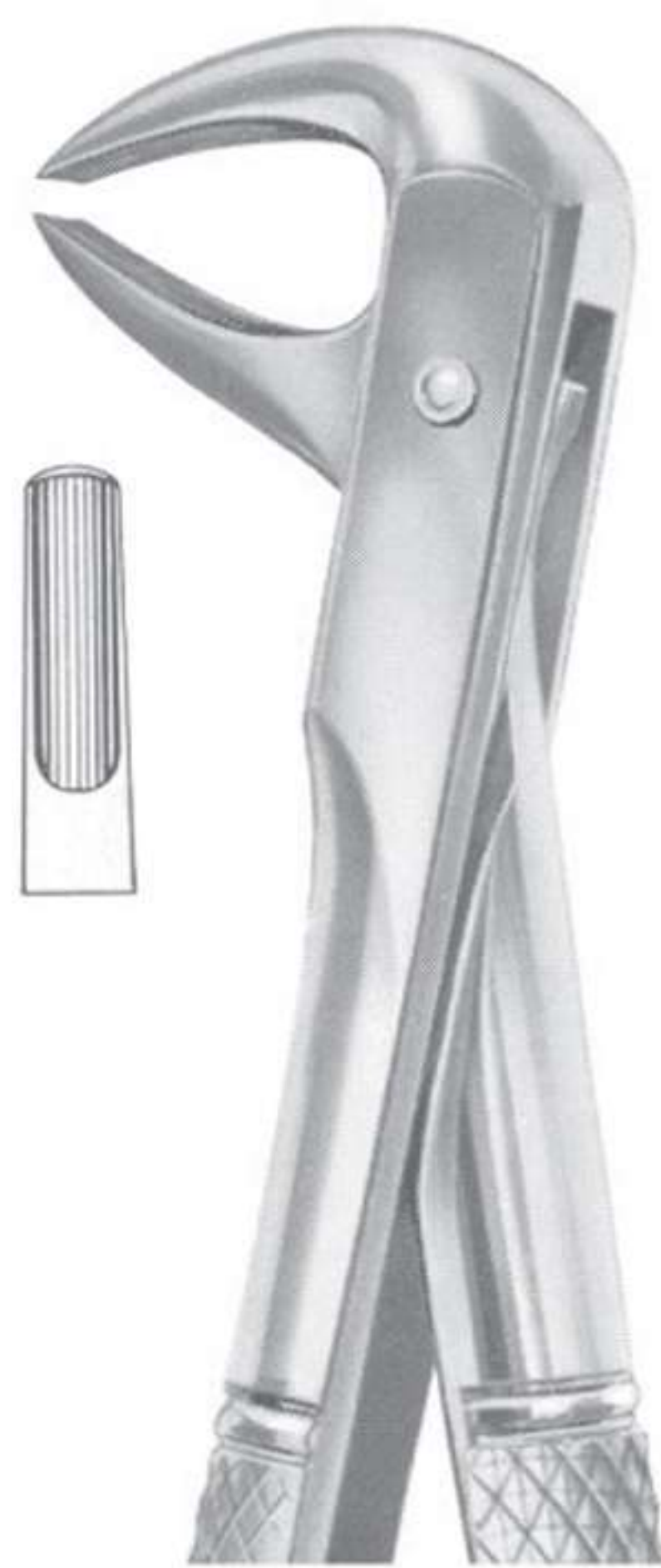

DMI-2-1076
Fig. 75 lower premolars



DMI-2-1077
Fig. 76 upper roots



DMI-2-1078
Fig. 76N upper roots



Extracting Forceps
Art: DSC-2-179
Fig. 73A lower molars



Extracting Forceps
ART-DSC-2-180
Fig. 73A lower molars



DMI-2-201
Fig. 1 upper laterals and canines



DMI-2-202
Fig. 2 upper laterals and canines



ART-DSC-2-203
Fig. 3 upper incisors and canines

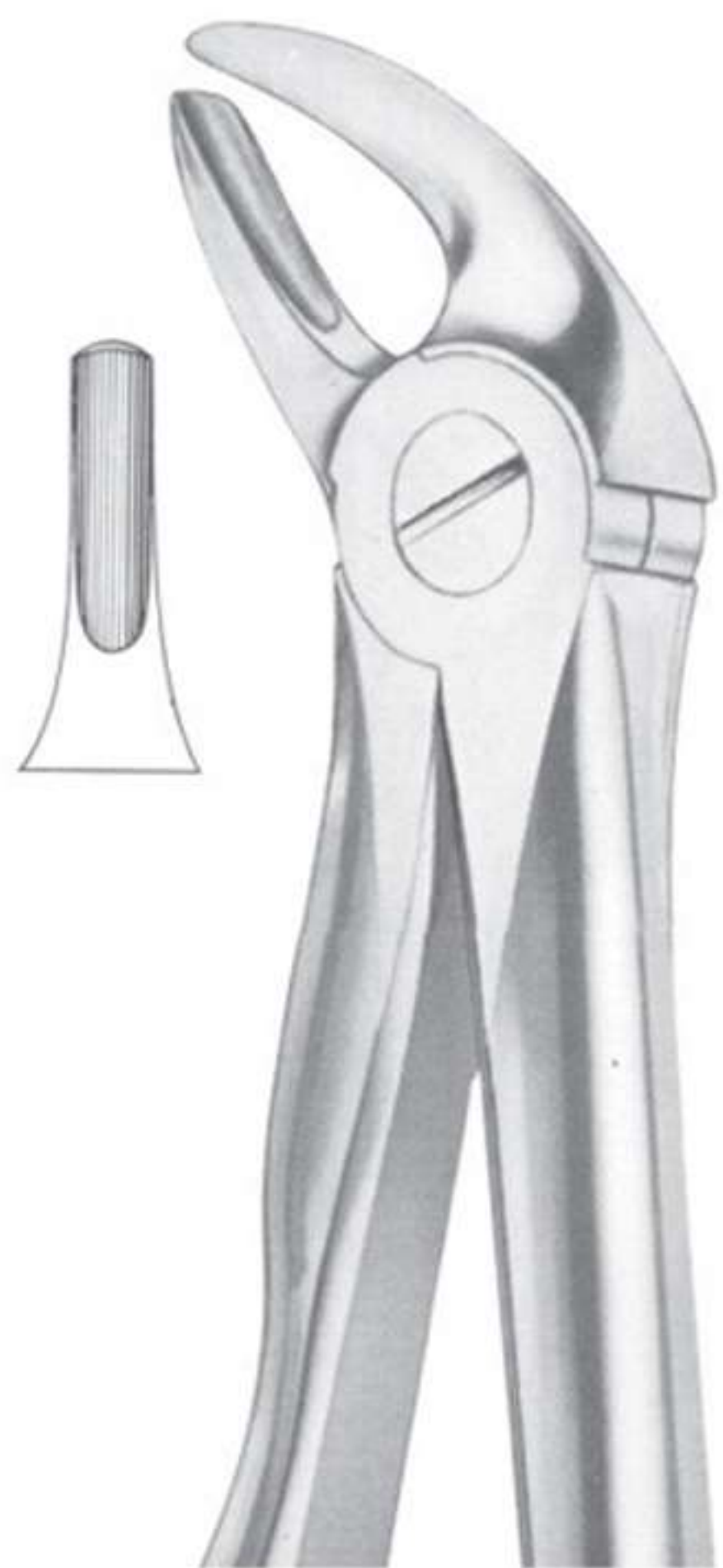

DMI-2-204
Fig. 4 lower incisors and canines



DMI-2-205
Fig. 7 upper premolars

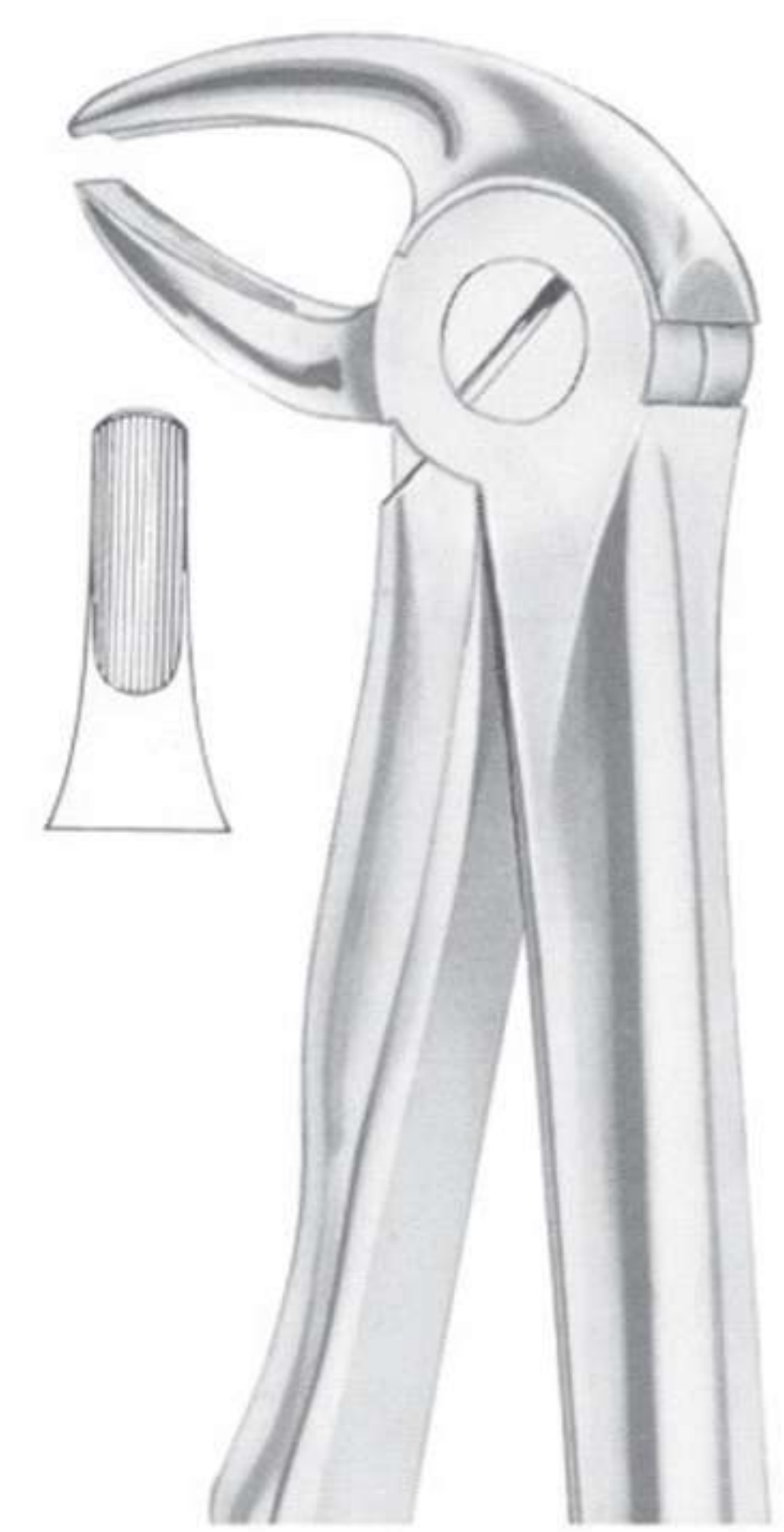

DMI-2-206
Fig. 13 lower premolars



DMI-2-207
Fig. 13S lower premolars
for children



DMI-2-208
Fig. 18 upper molars left



DMI-2-209
Fig. 18 upper molars left

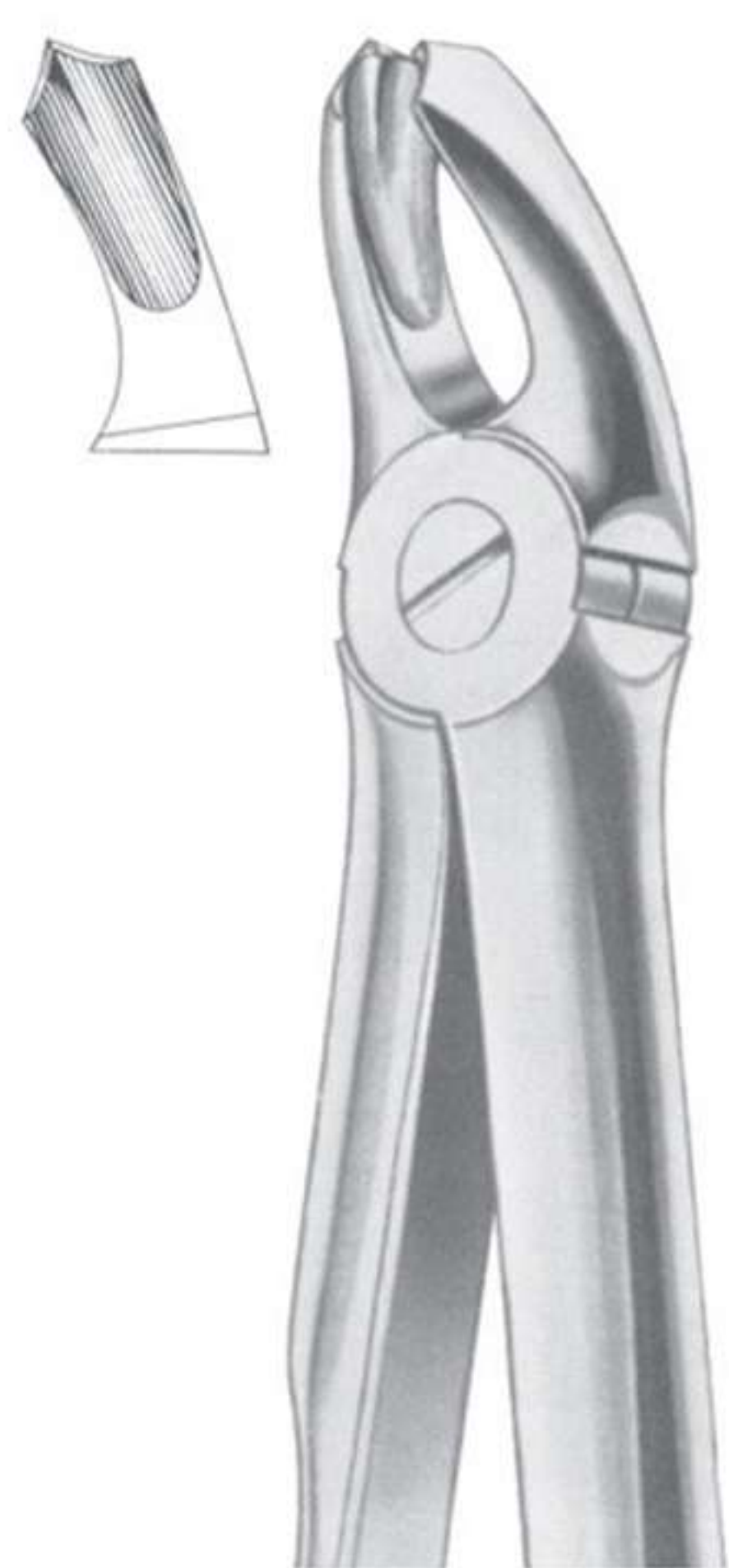

DMI-2-210
Fig. 18A upper molars

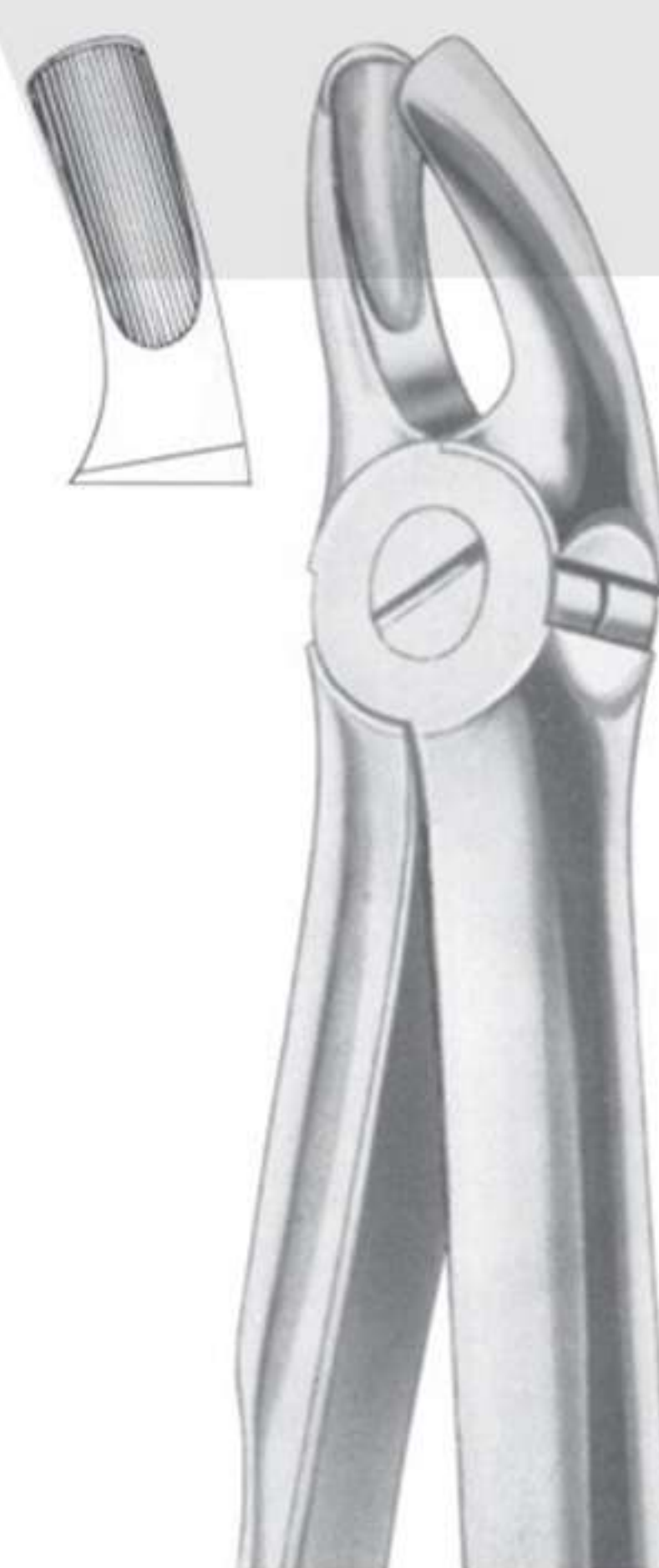

DMI-2-211
Fig. 18B upper molars

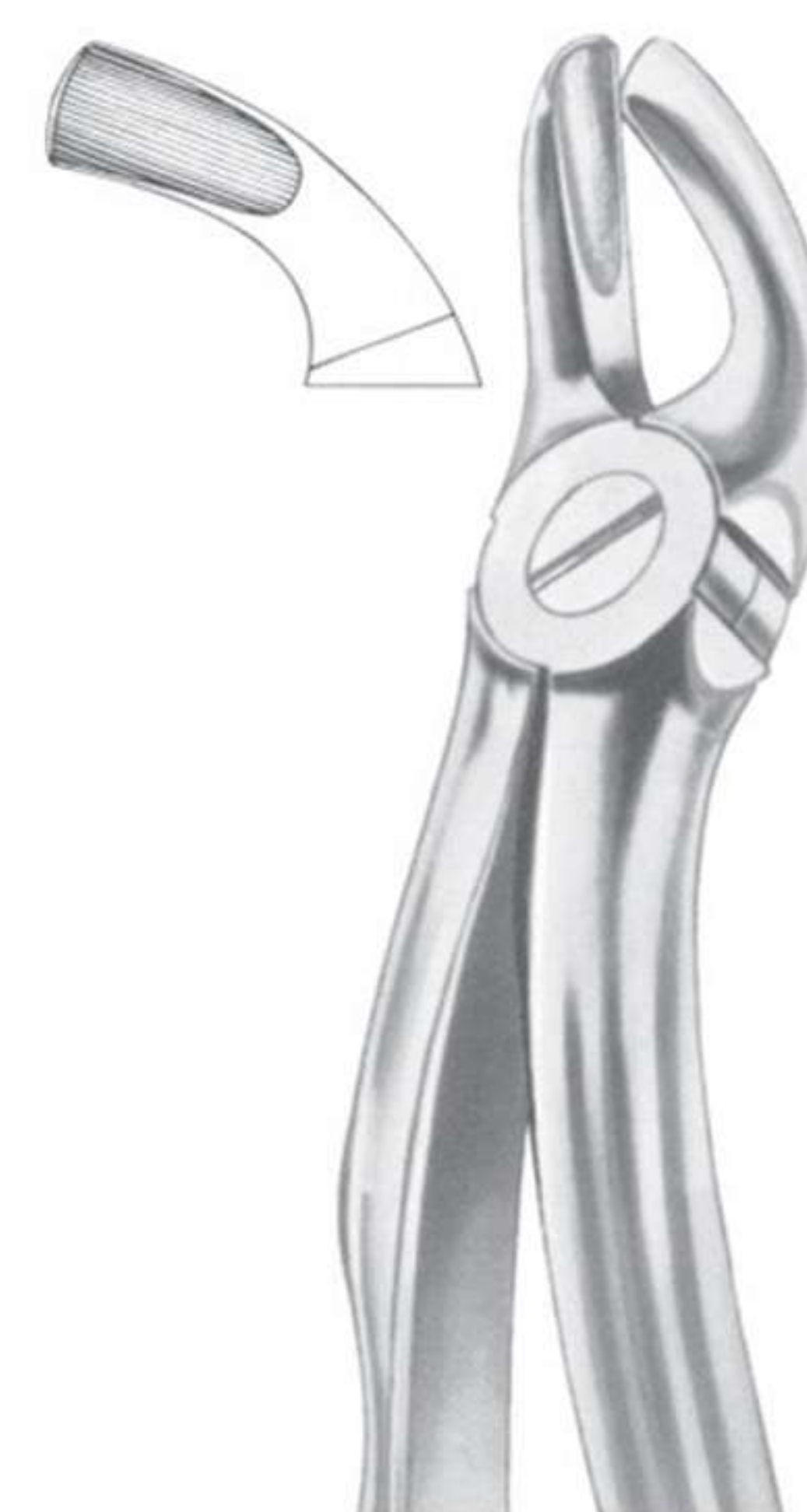

DMI-2-212
Fig. 19 upper third molars

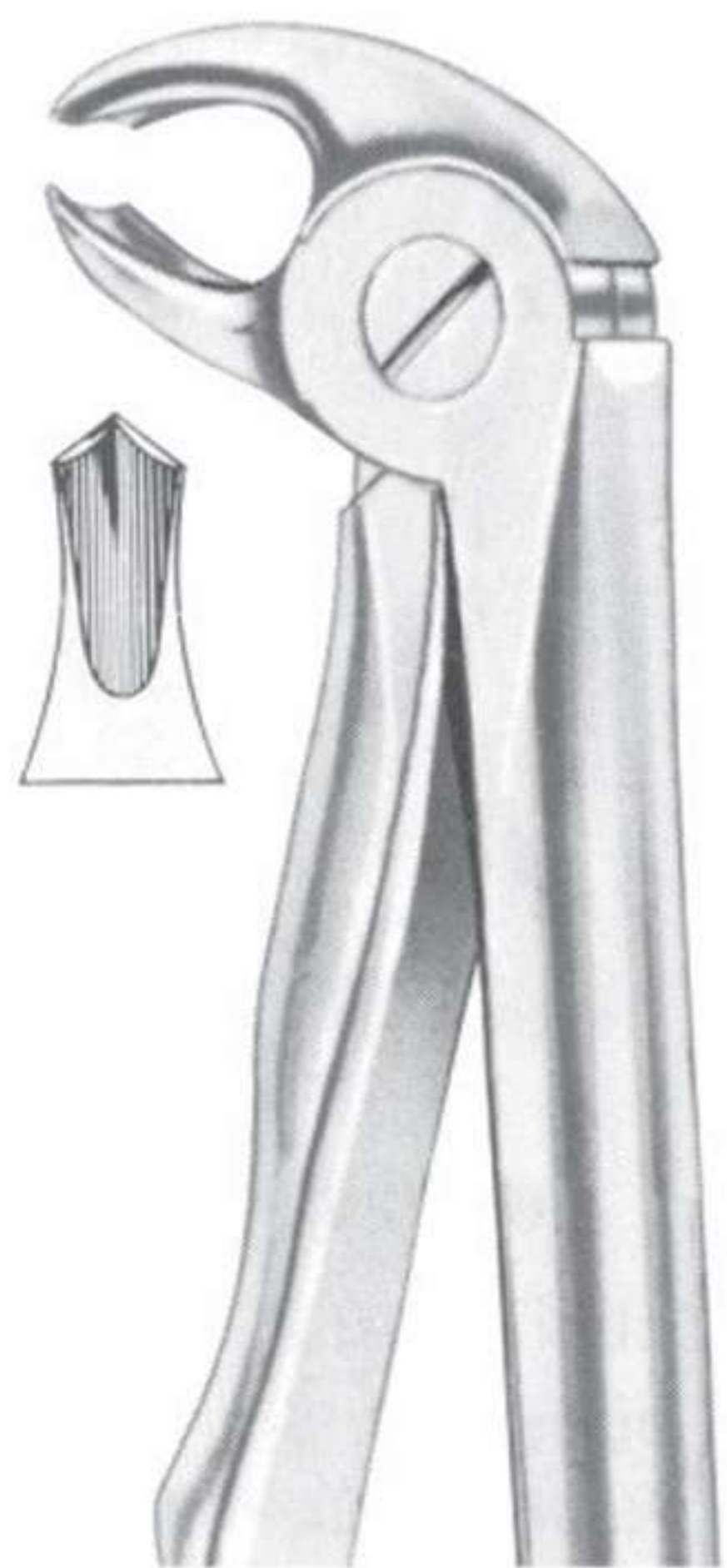

DMI-2-213
Fig. 22 lower molars



DMI-2-214
Fig. 22S lower molars
for children



DMI-2-215
Fig. 29 upper roots

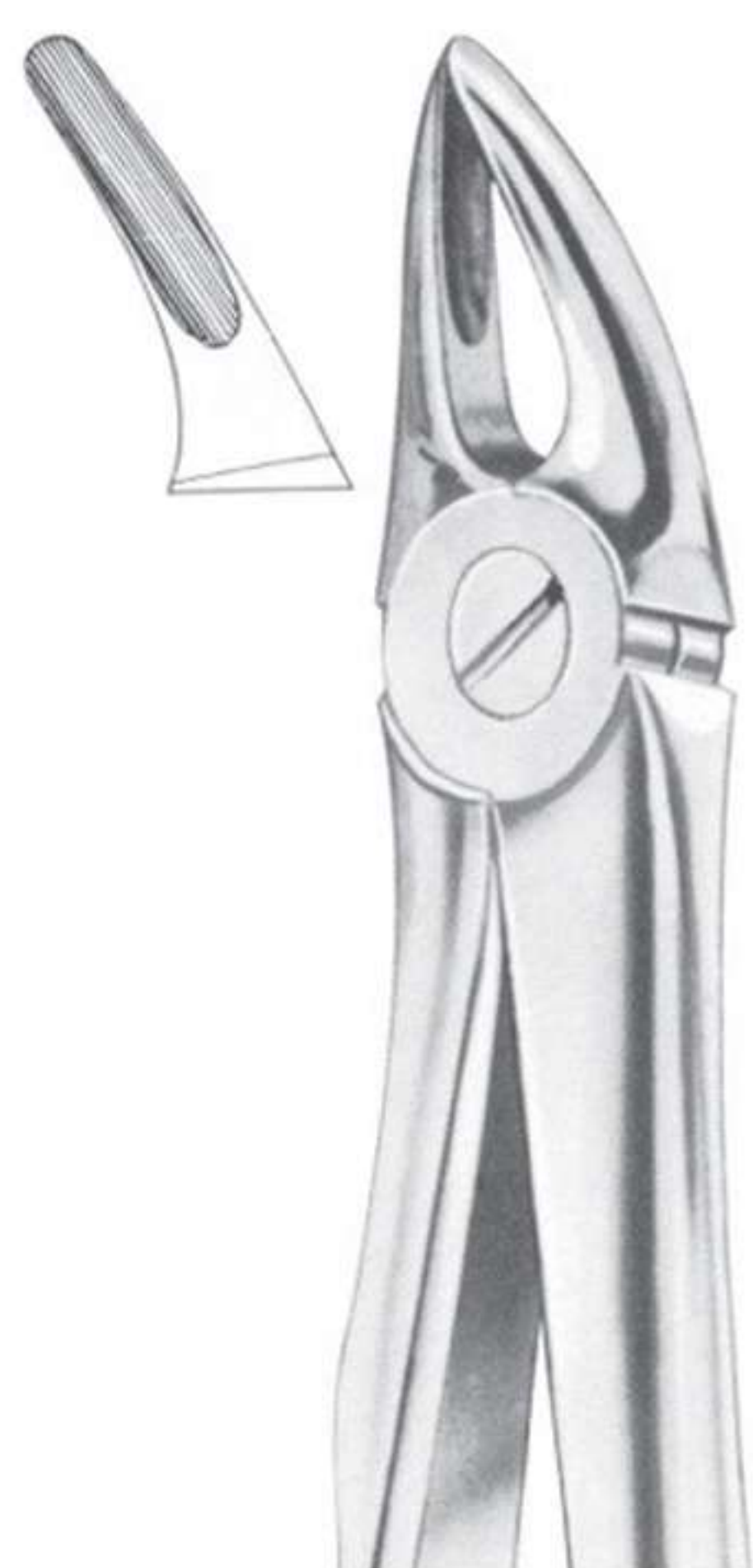

DMI-2-216
Extracting Forceps English Pattern



DMI-2-217
Fig. 30 upper roots

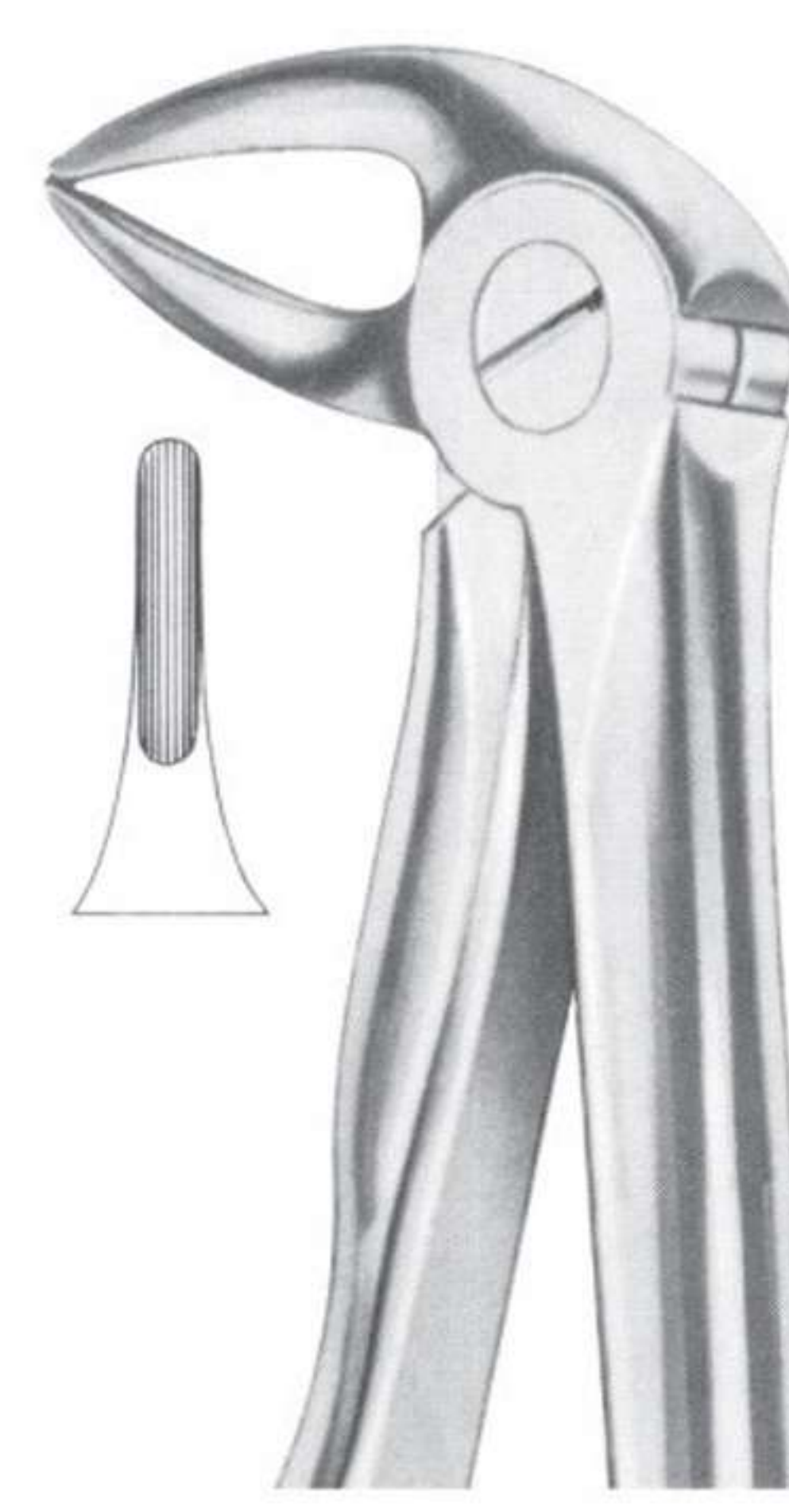

DMI-2-218
Fig. 30S upper roots for children

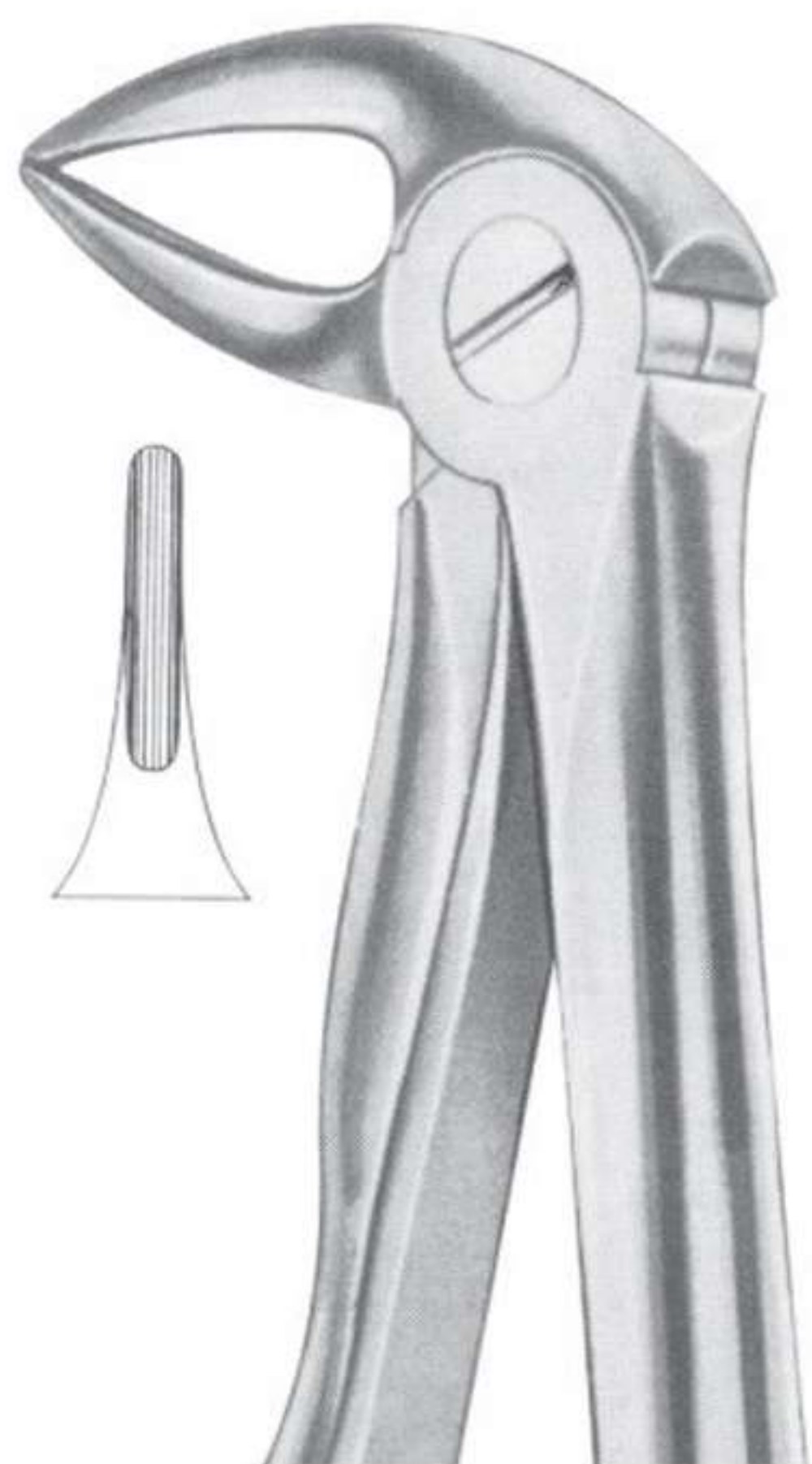

DMI-2-219
Fig. 33 lower roots

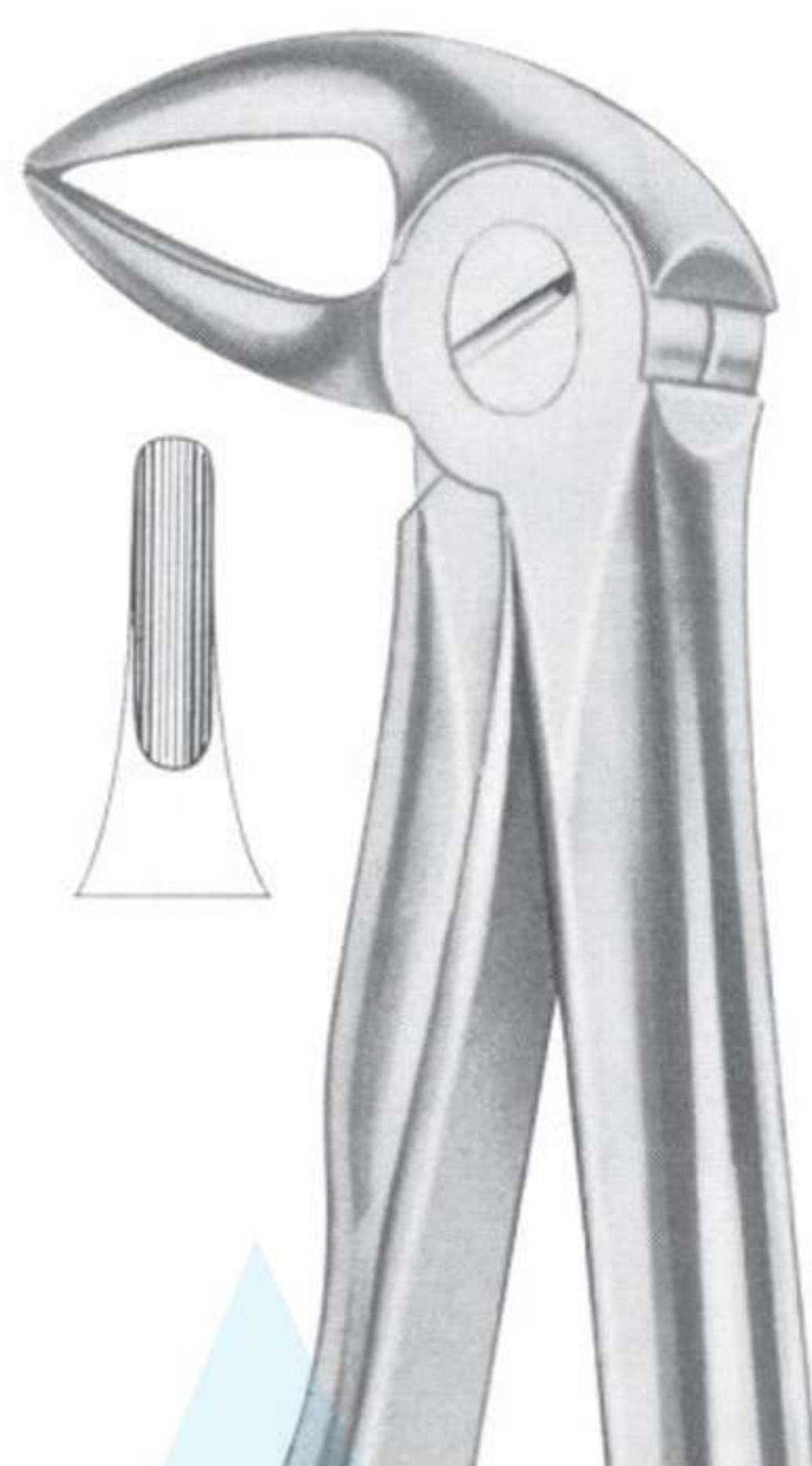

DMI-2-220
Fig. 33A lower roots



DMI-2-221
Fig. 33B lower roots

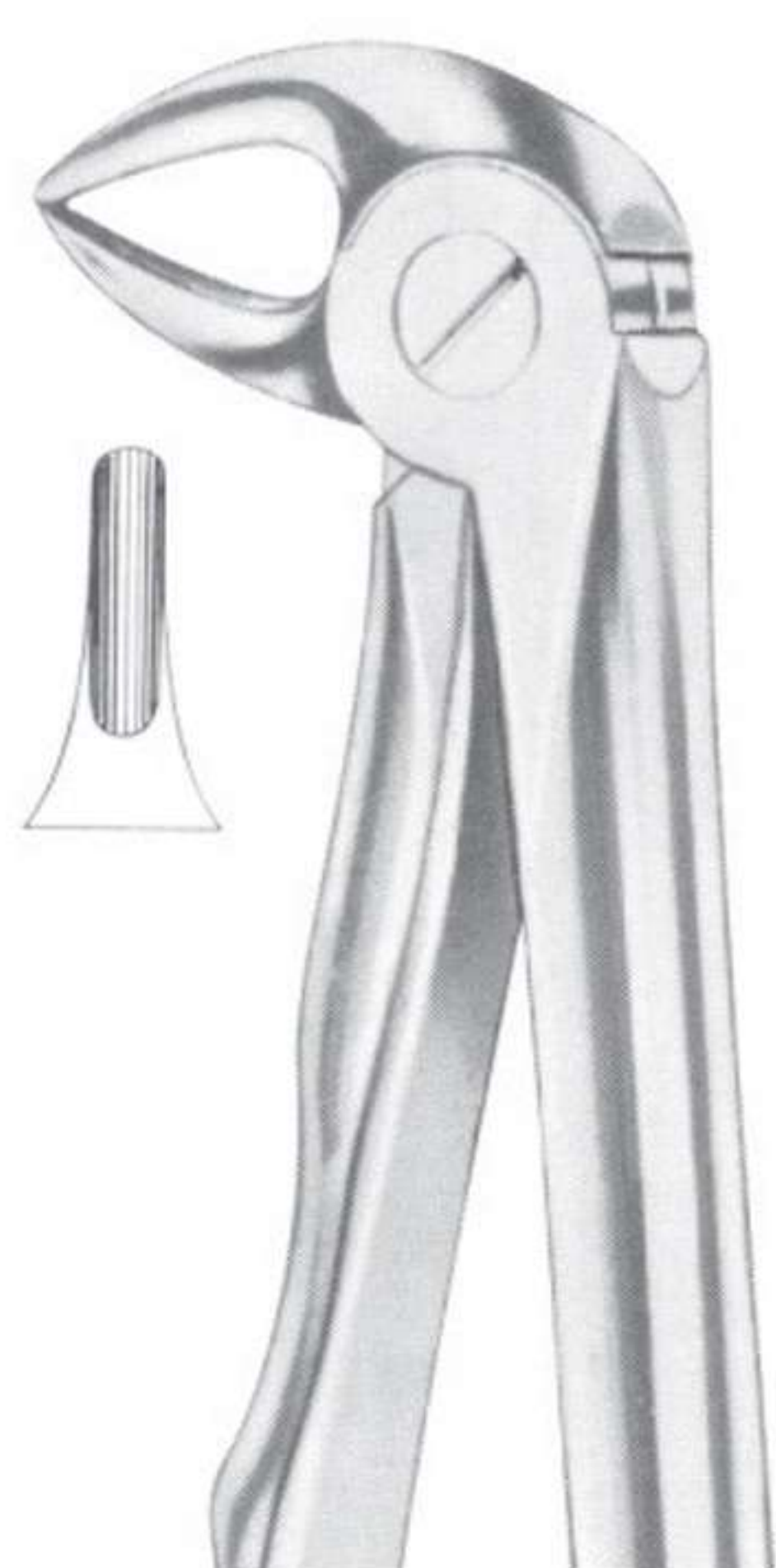

DMI-2-222
Fig. 33L lower roots

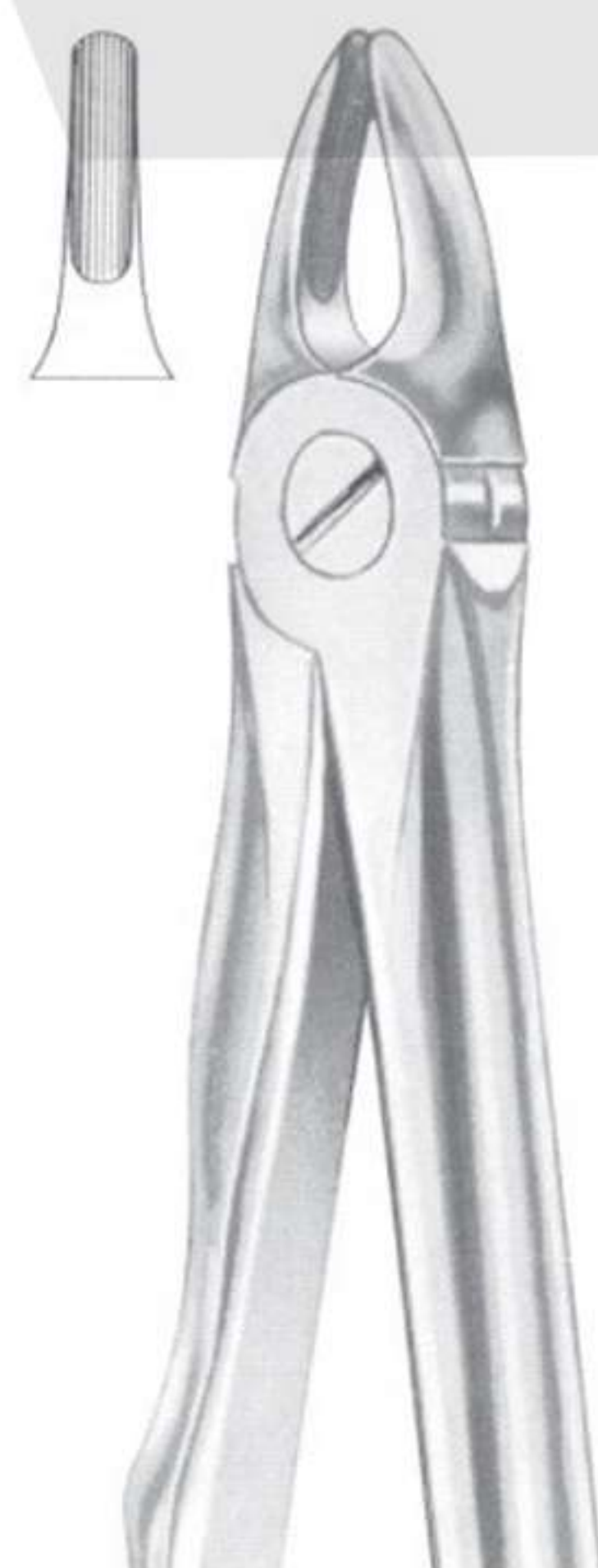

DMI-2-223
Fig. 33S lower roots for children



DMI-2-224
Fig. 37 upper incisors for children



DMI-2-225
Fig. 39 upper incisors
for children



DMI-2-226
Fig. 39L upper molars left
for children



DMI-2-227
Fig. 41 upper roots



DMI-2-228
Fig. 44 upper roots



DMI-2-229
Fig. 44 upper roots

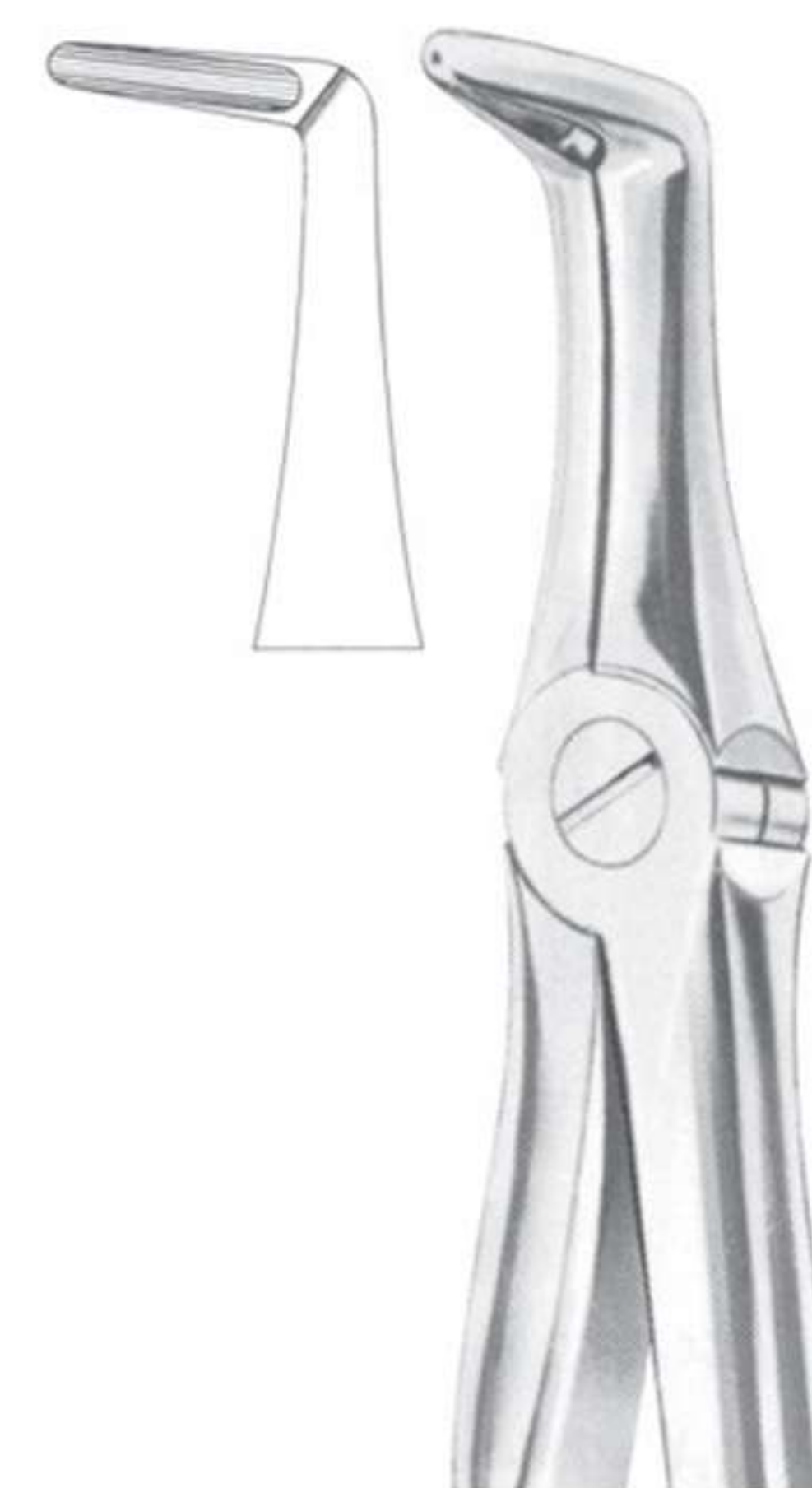

DMI-2-230
Fig. 45 lower roots

Extracting Forceps English Pattern

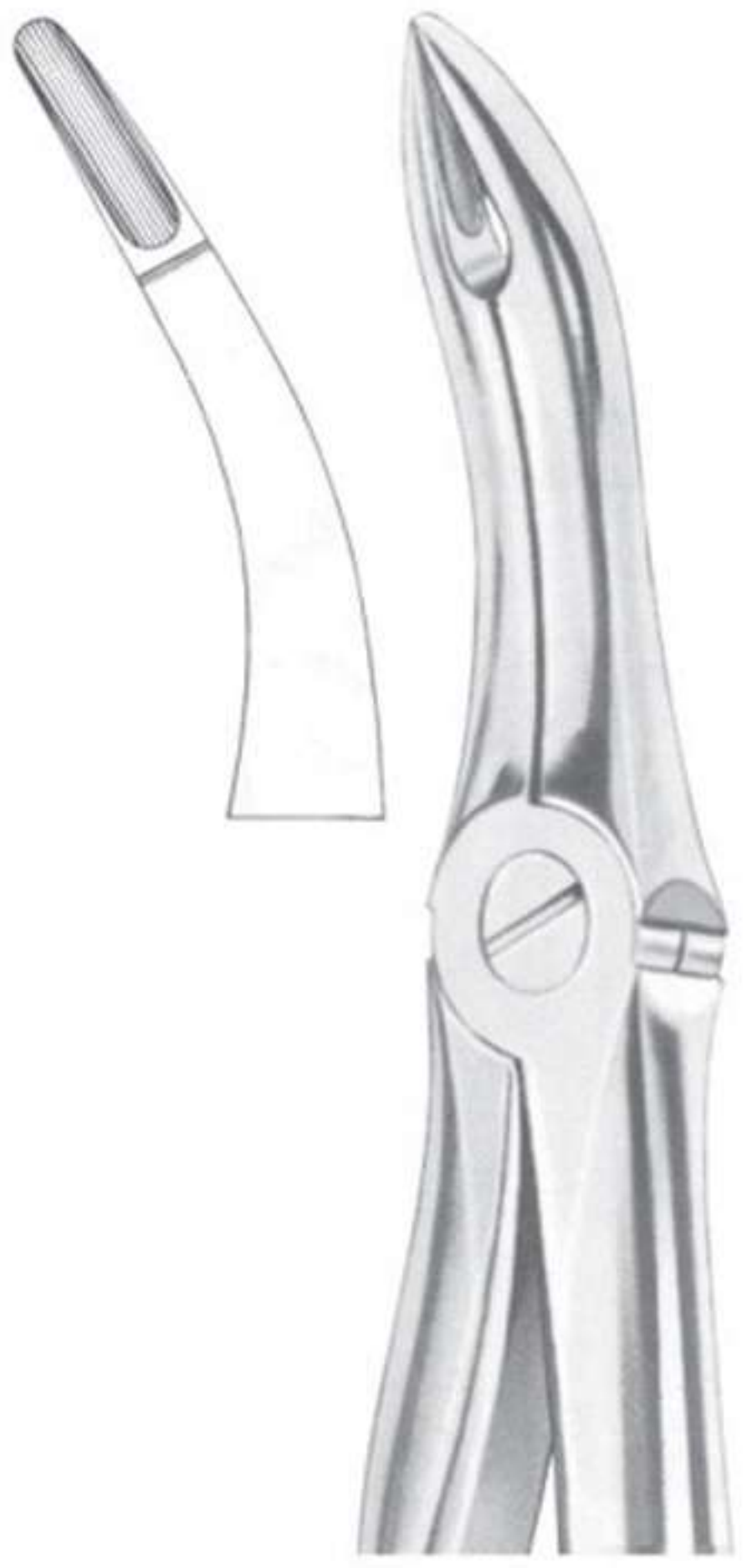

DMI-2-231
Fig. 48 lower roots

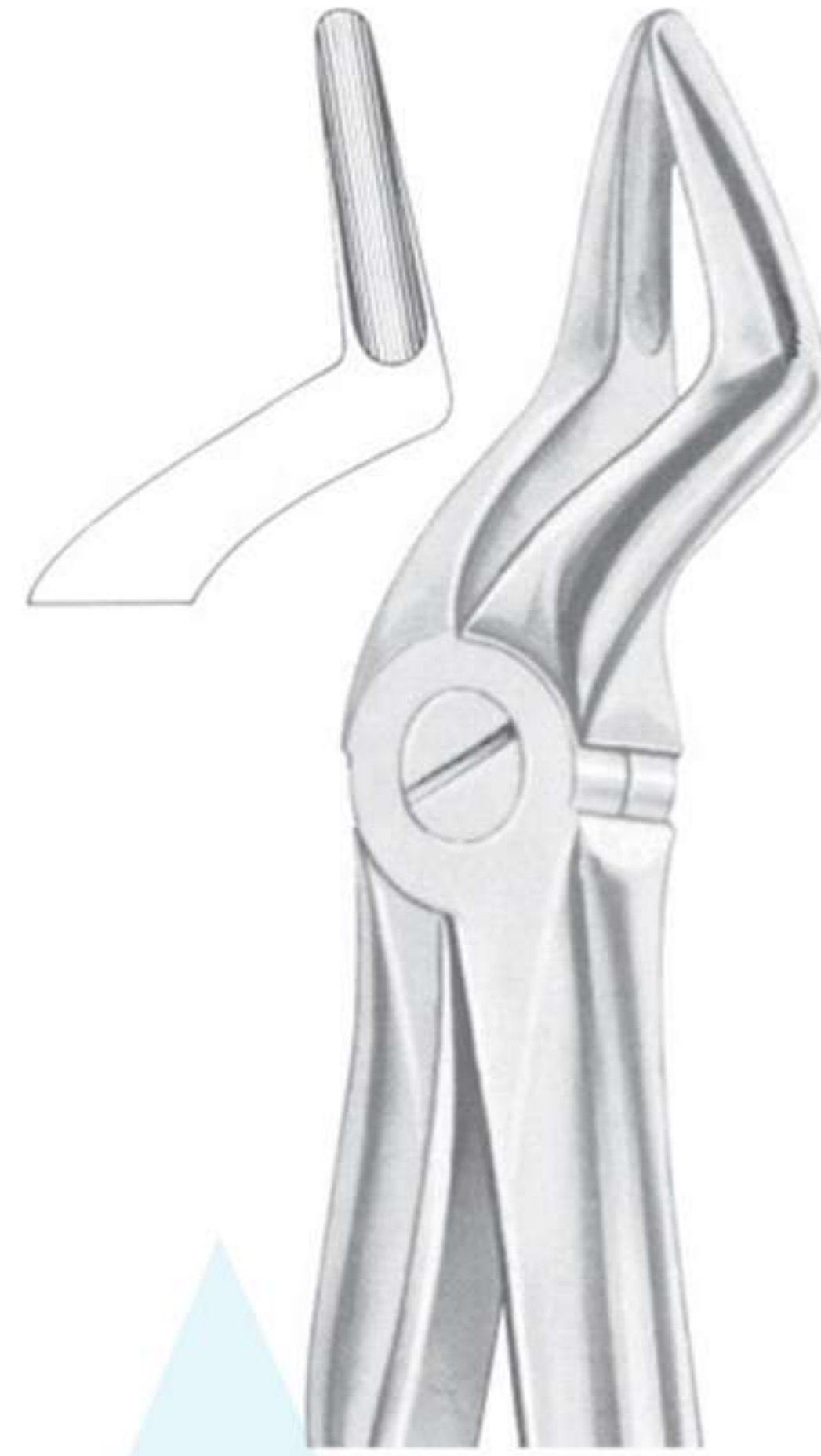

DMI-2-232
Fig. 51 upper roots



DMI-2-233
Fig. 51A upper roots



DMI-2-234
Fig. 51S upper roots
for children

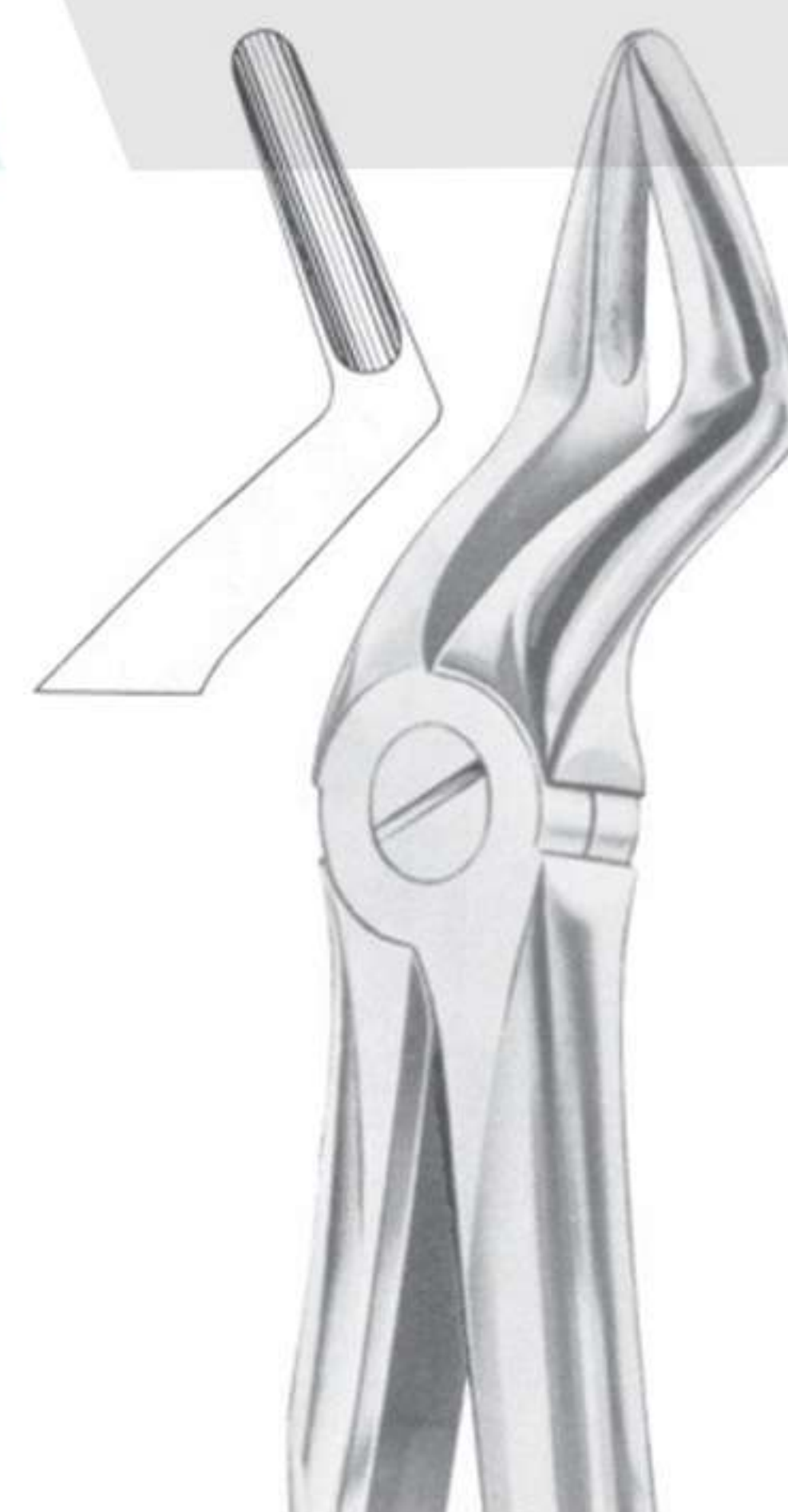

DMI-2-235
Fig. 51L upper roots

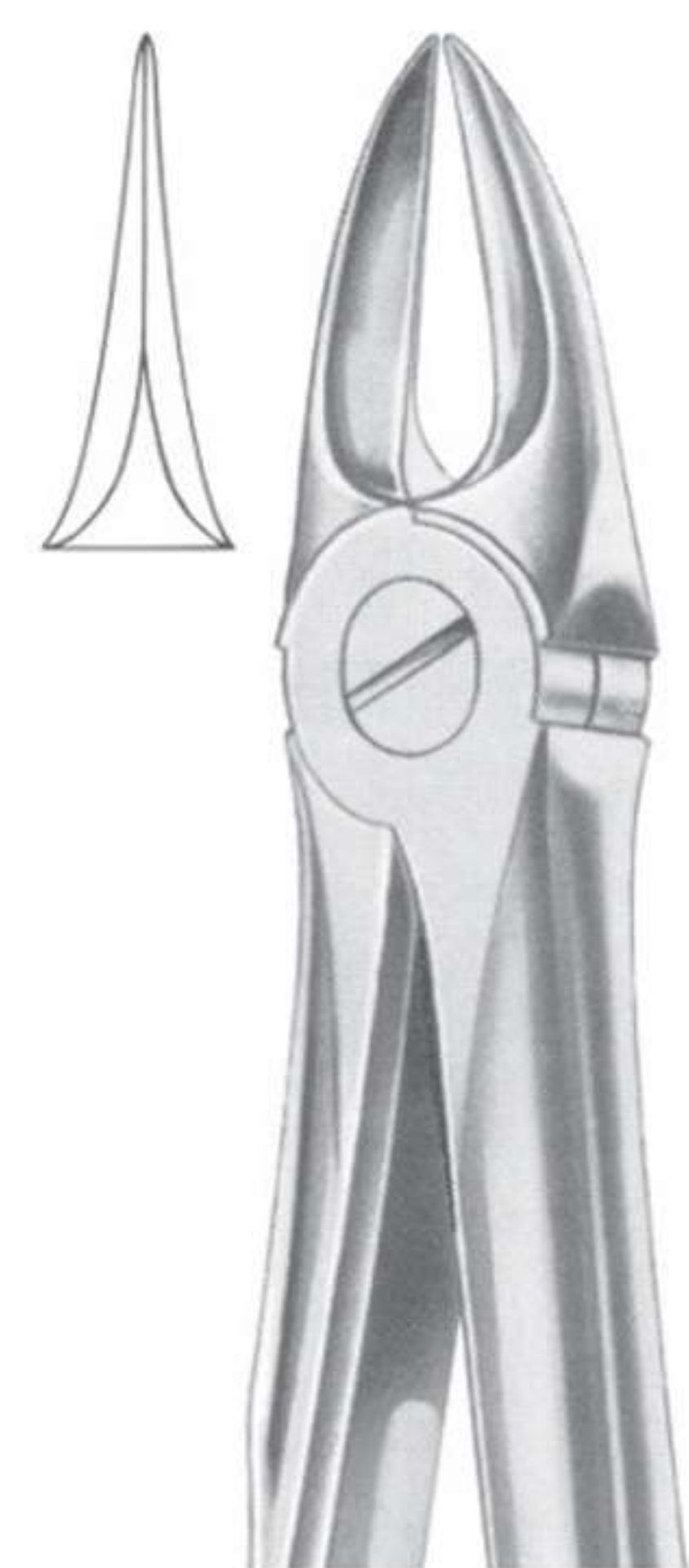

DMI-2-236
Fig. 52 upper roots

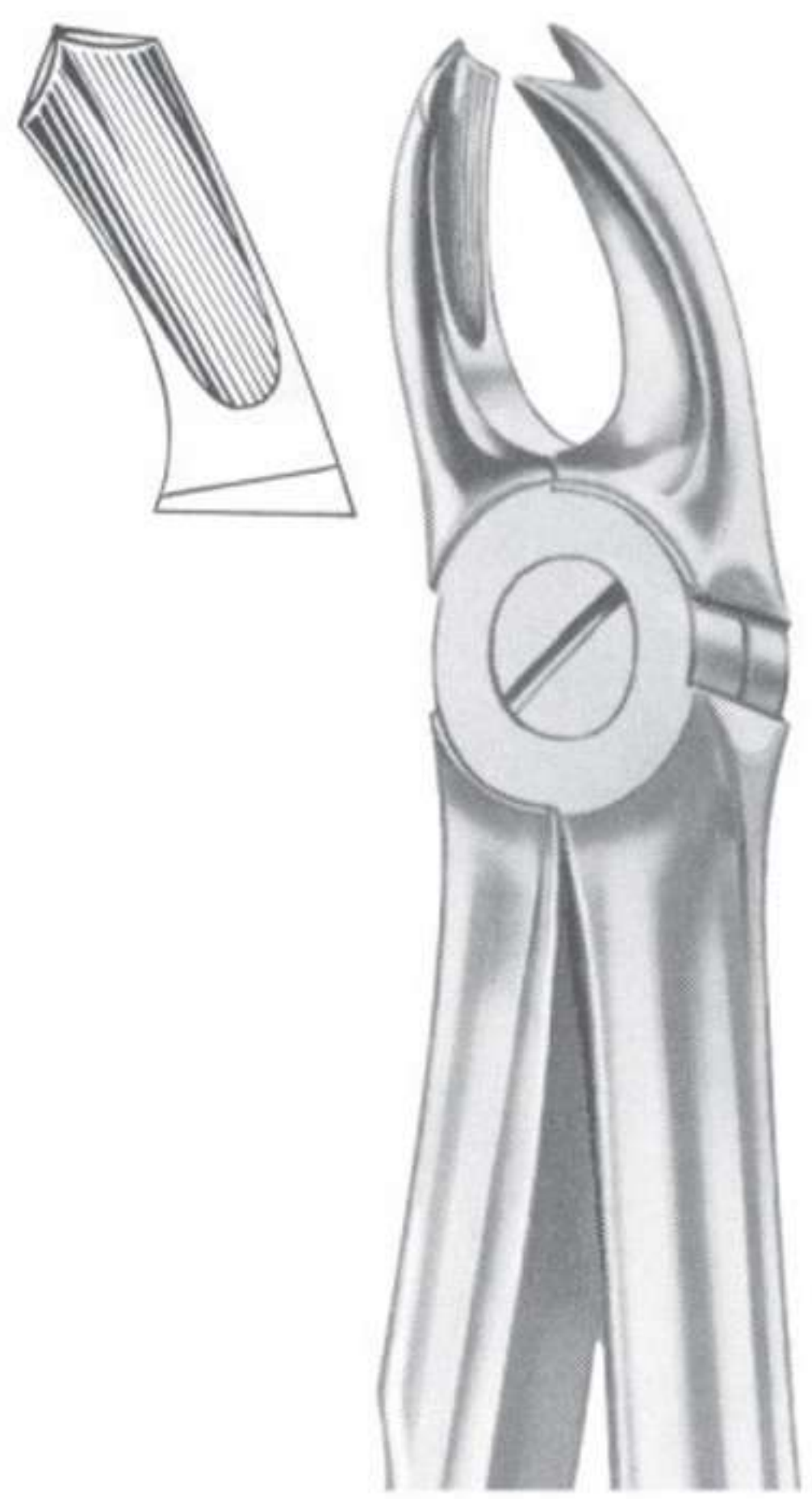

DMI-2-237
Fig. 65R upper molars right

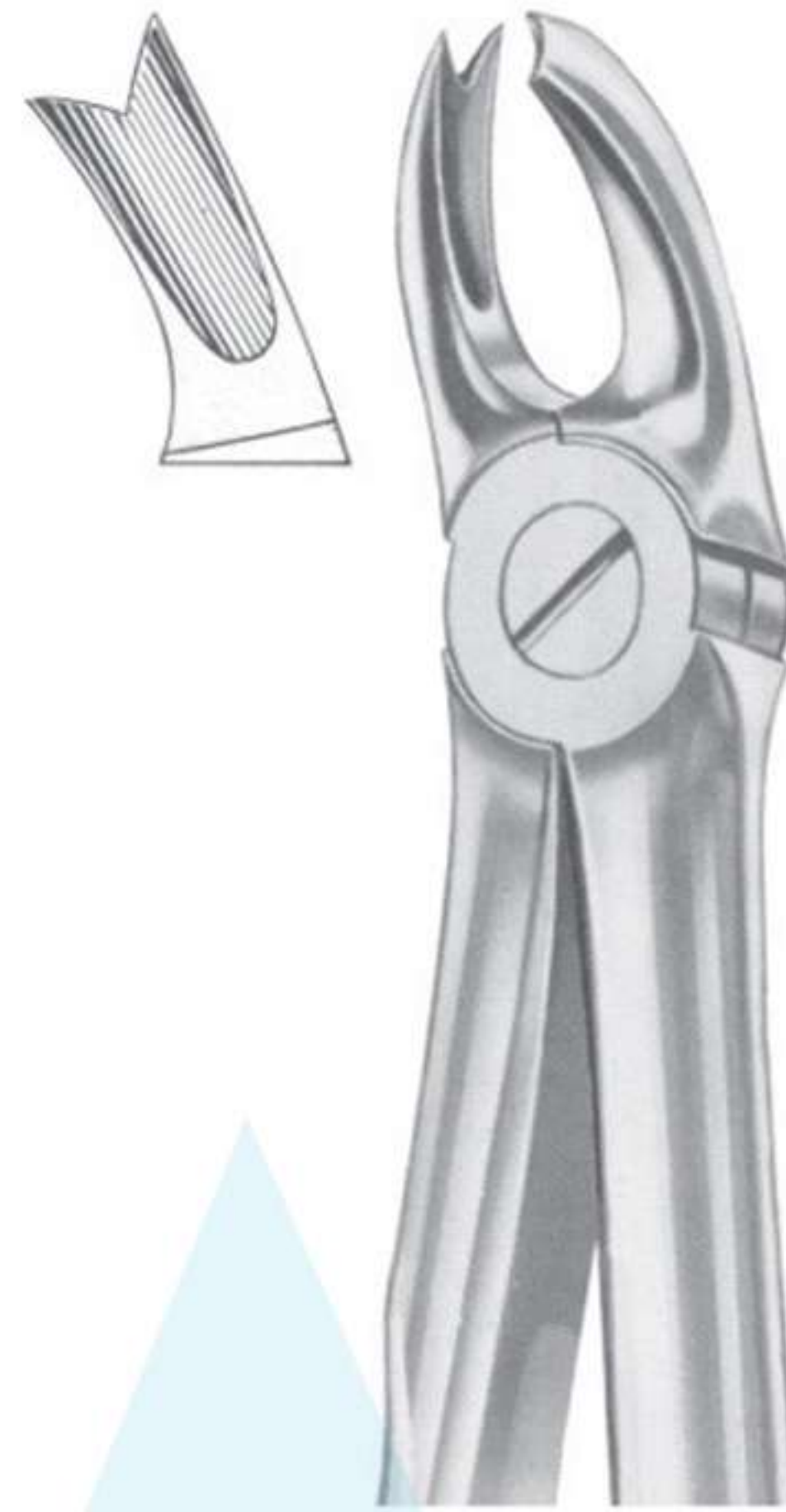

DMI-2-238
Fig. 65L upper molars left



DMI-2-239
Fig. 67 upper third molars

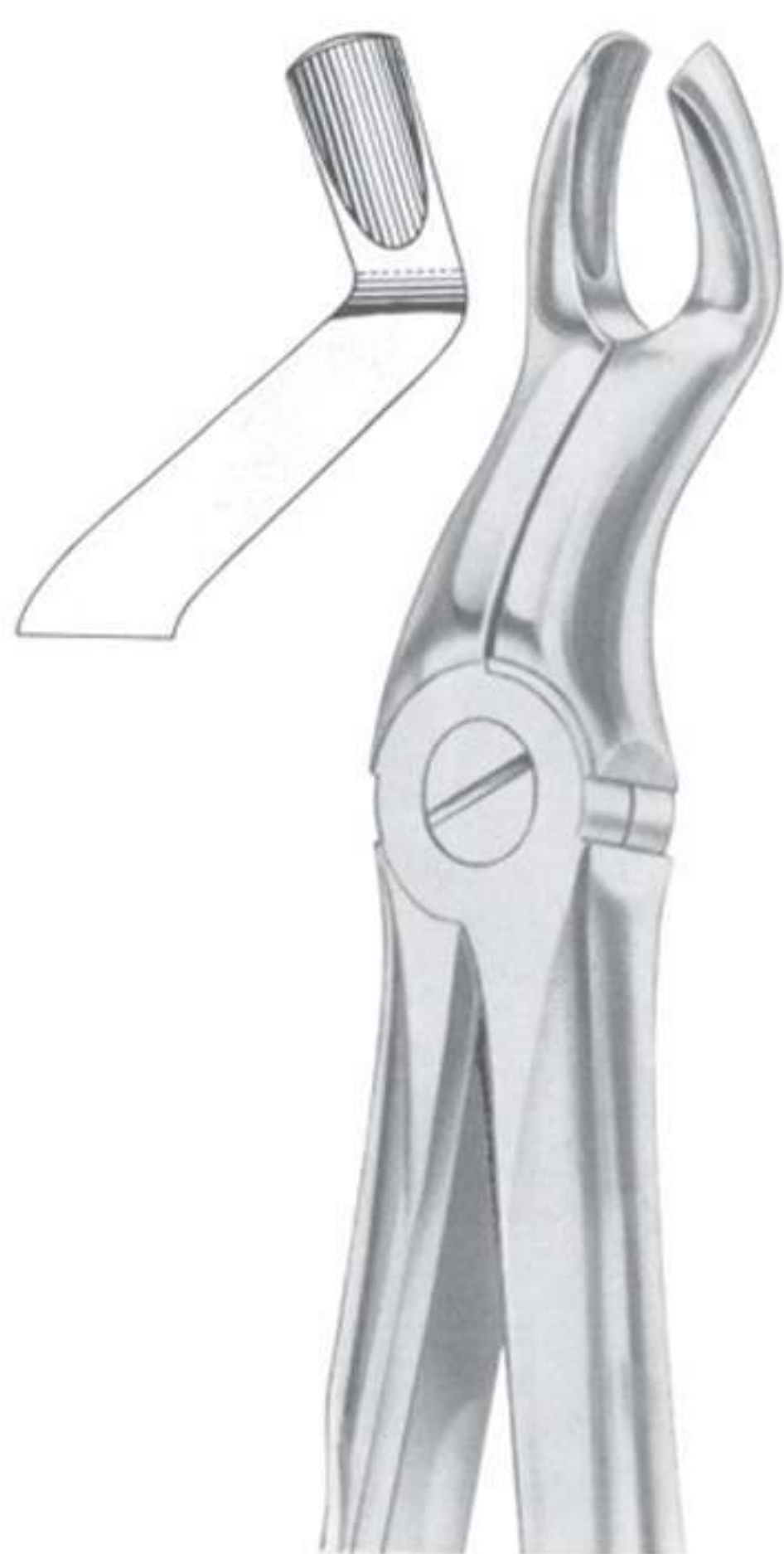
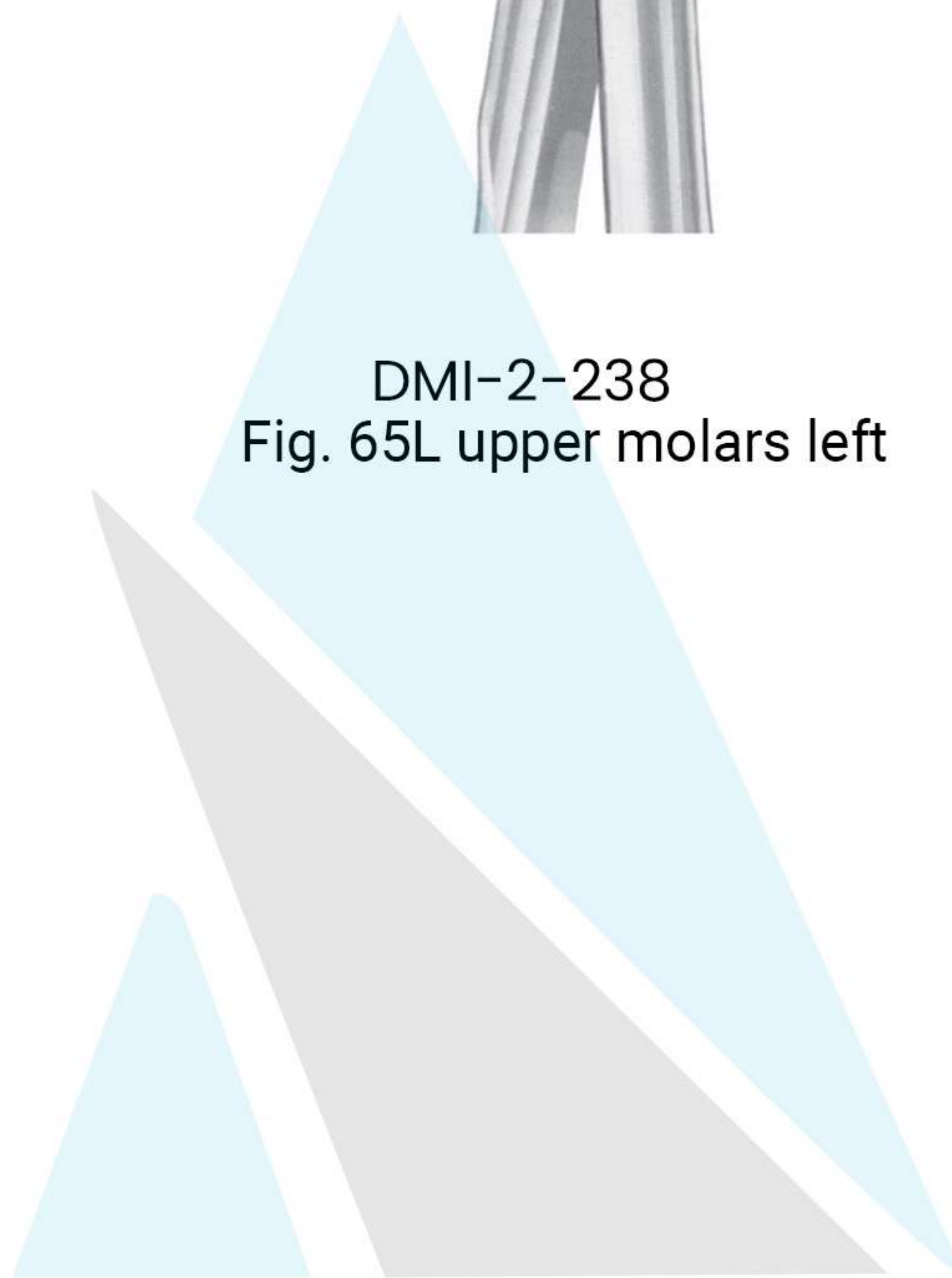

DMI-2-240
Fig. 67A upper third molars



DMI-2-241
Fig. 67 1/2 R upper third molars right

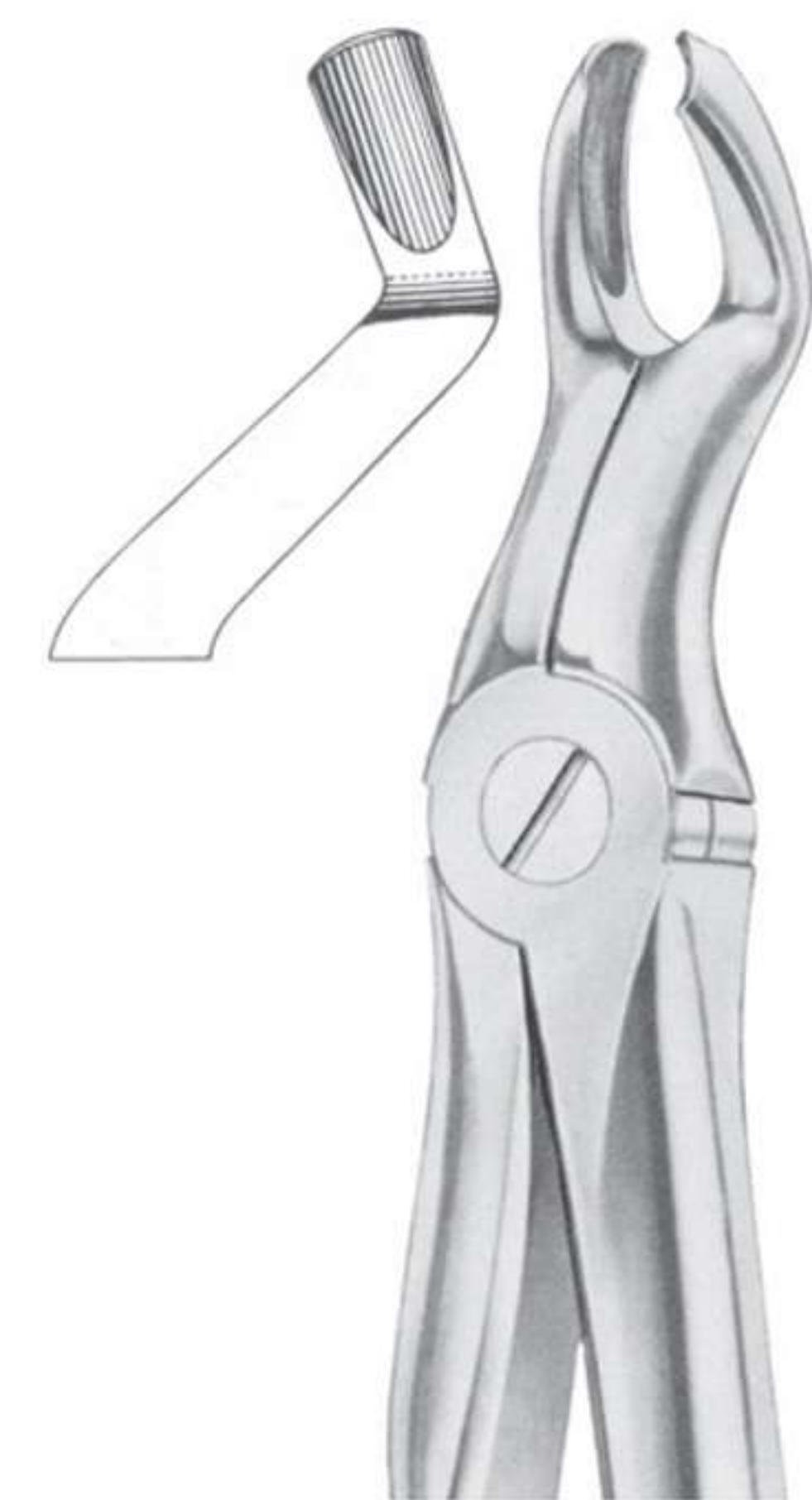

DMI-2-242
Fig. 67 1/2 L upper third molars left

Extracting Forceps English Pattern

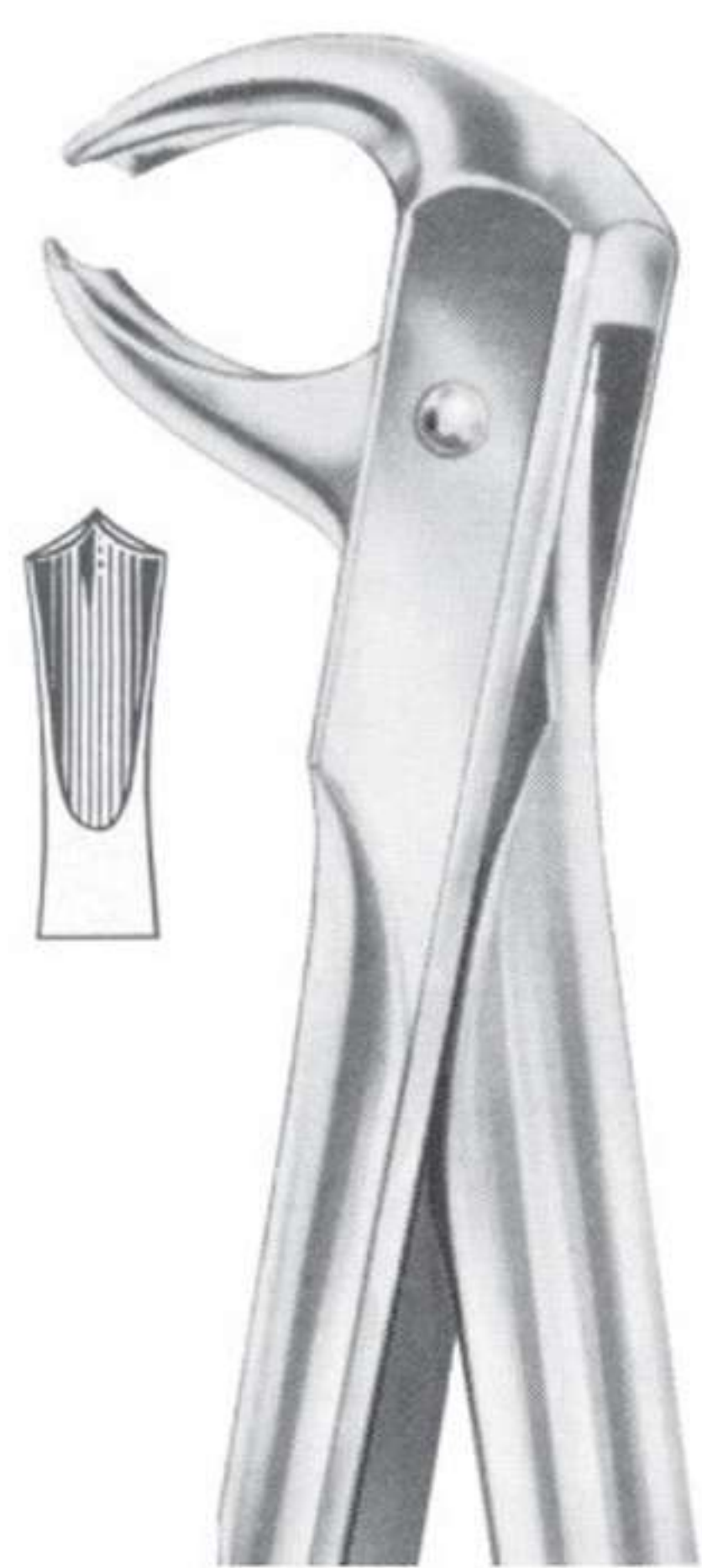

DMI-2-243
Fig. 73 lower molars

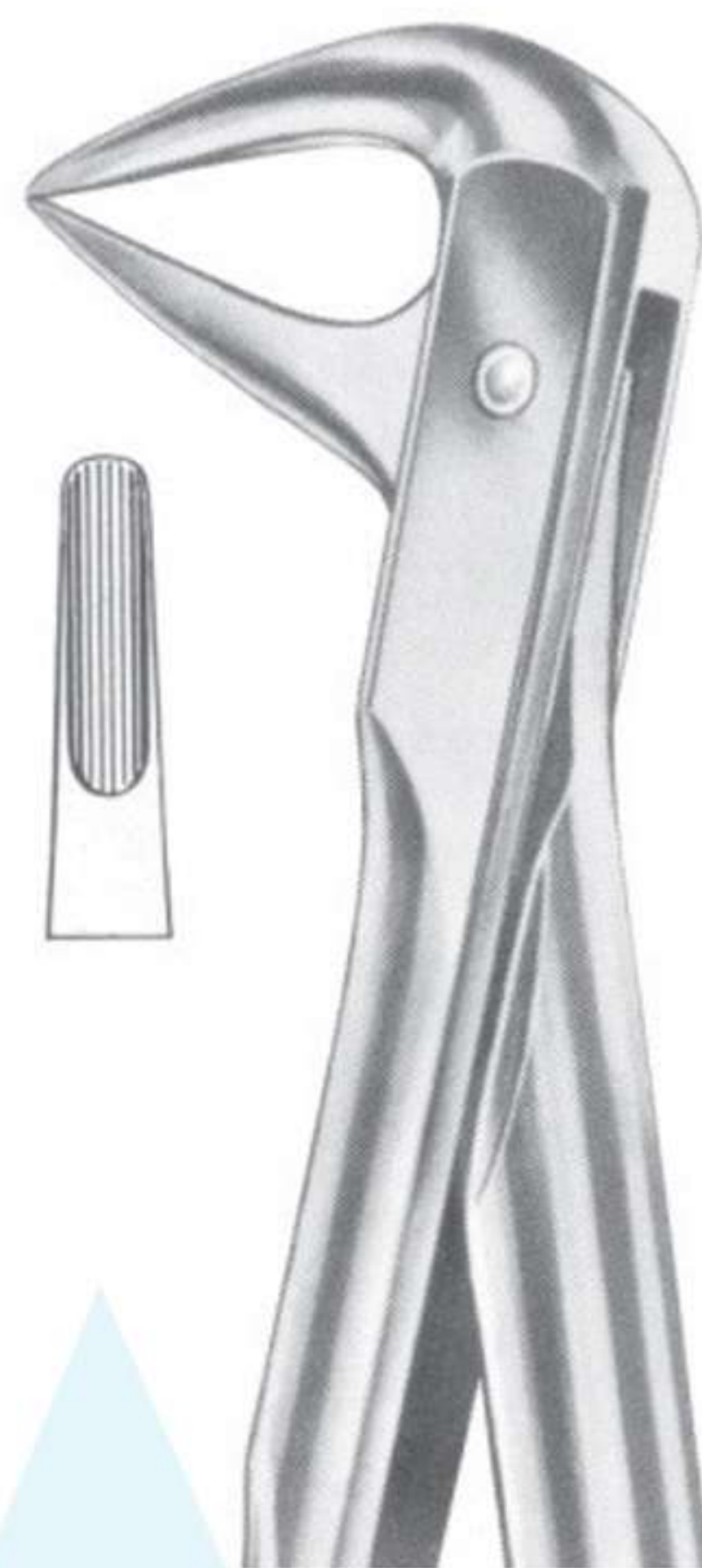

DMI-2-244
Fig. 73 lower molars

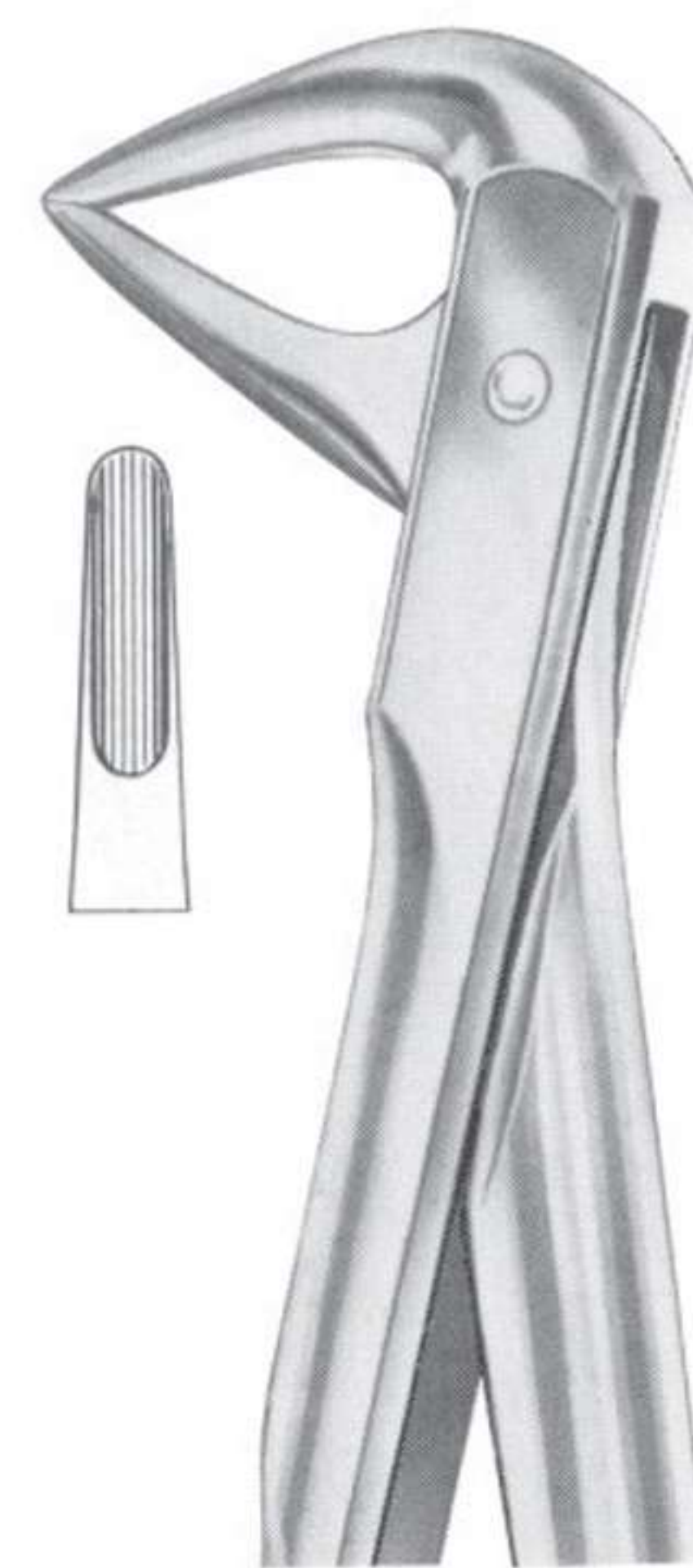

DMI-2-245
Fig. 74 lower roots



DMI-2-246
Fig. 74N lower roots



DMI-2-247
Fig. 74XN lower roots and
crowded incisors



DMI-2-248
Fig. 75 lower premolars

Extracting Forceps English Pattern



DMI-2-249
Fig. 76 upper roots



DMI-2-250
Fig. 76N upper roots

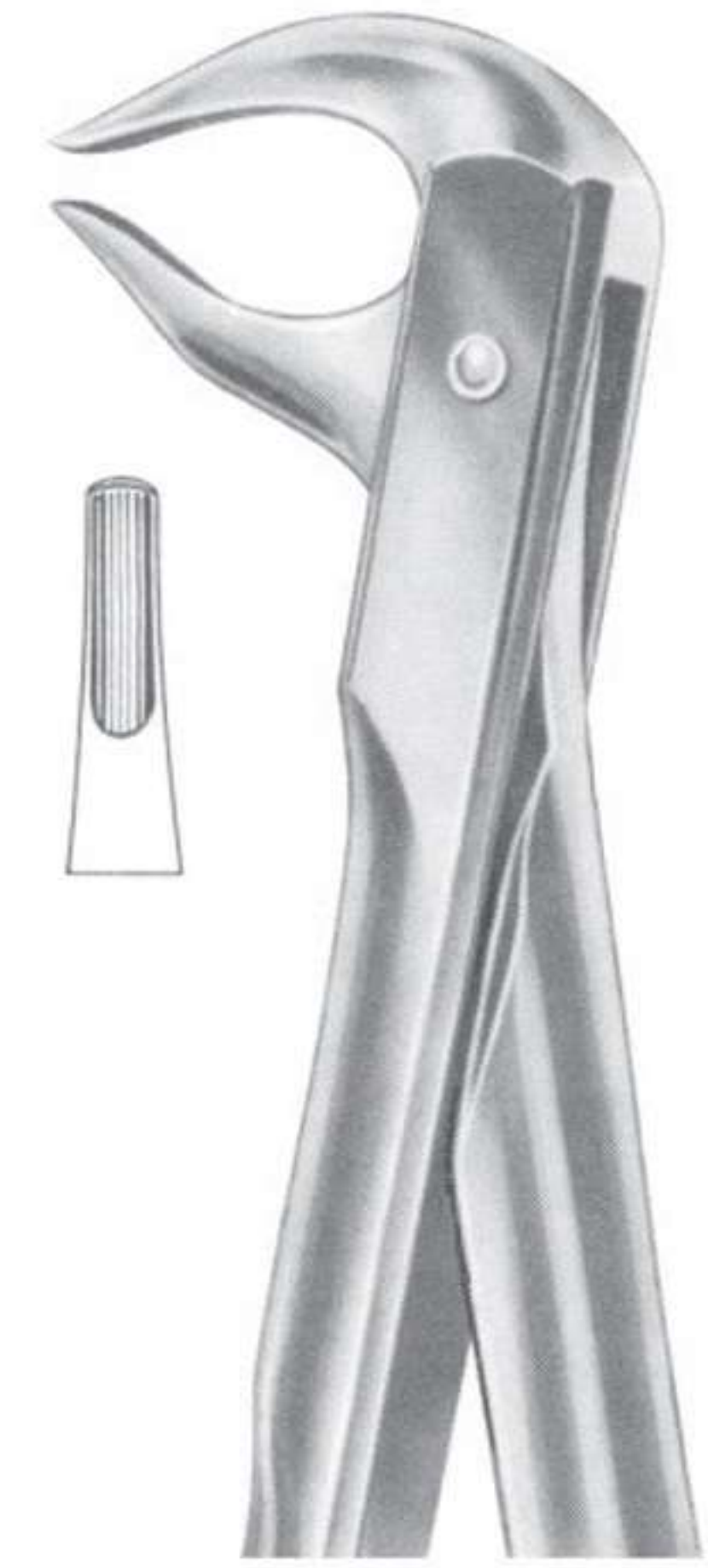

DMI-2-251
Fig. 81 lower premolars
and roots

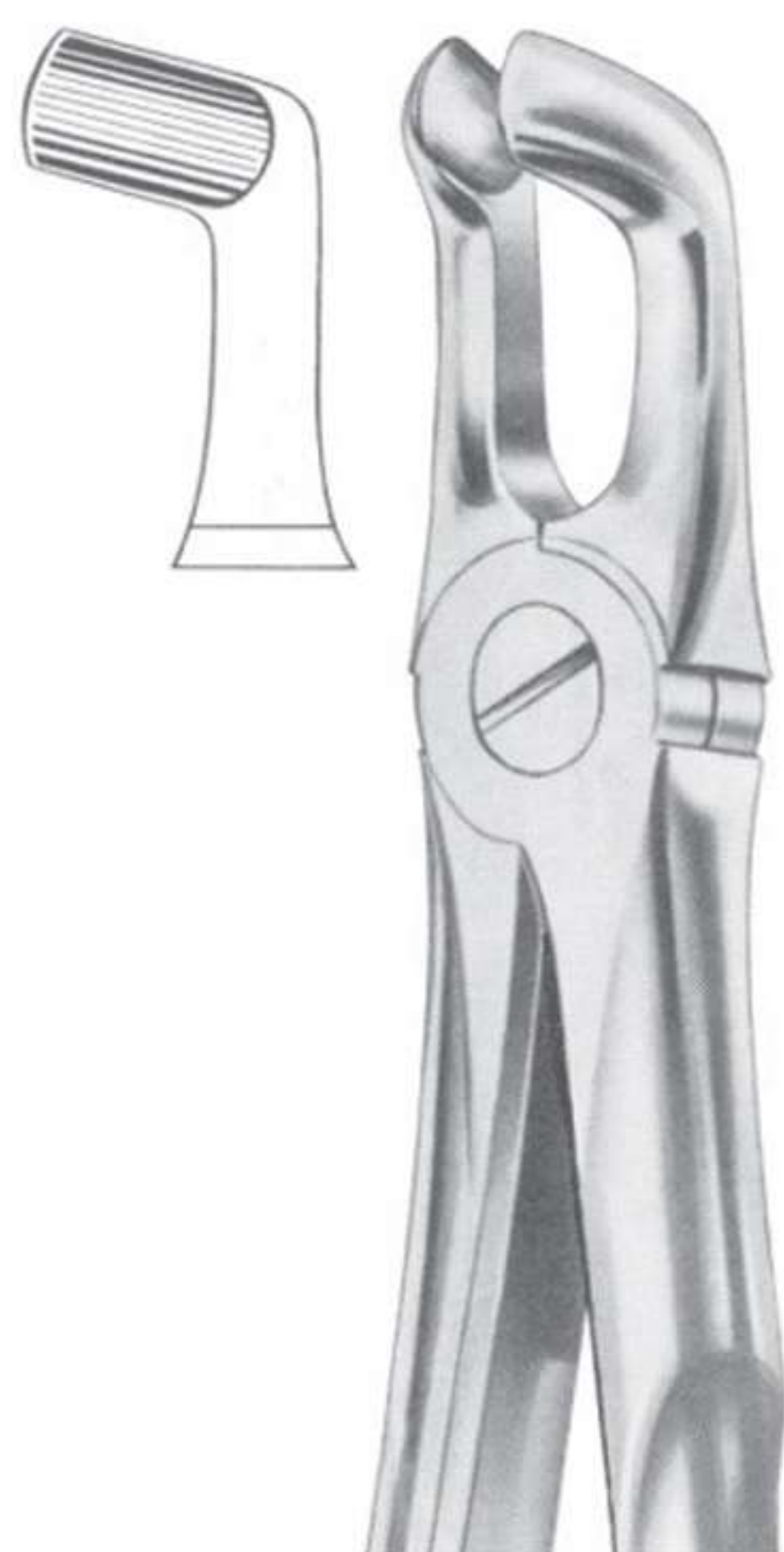

DMI-2-252
Fig. 76A lower third molars



DMI-2-253
Fig. 79 lower third molars



DMI-2-254
Fig. 86A lower molars

Extracting Forceps English Pattern



DMI-2-255
Fig. 86B lower molars

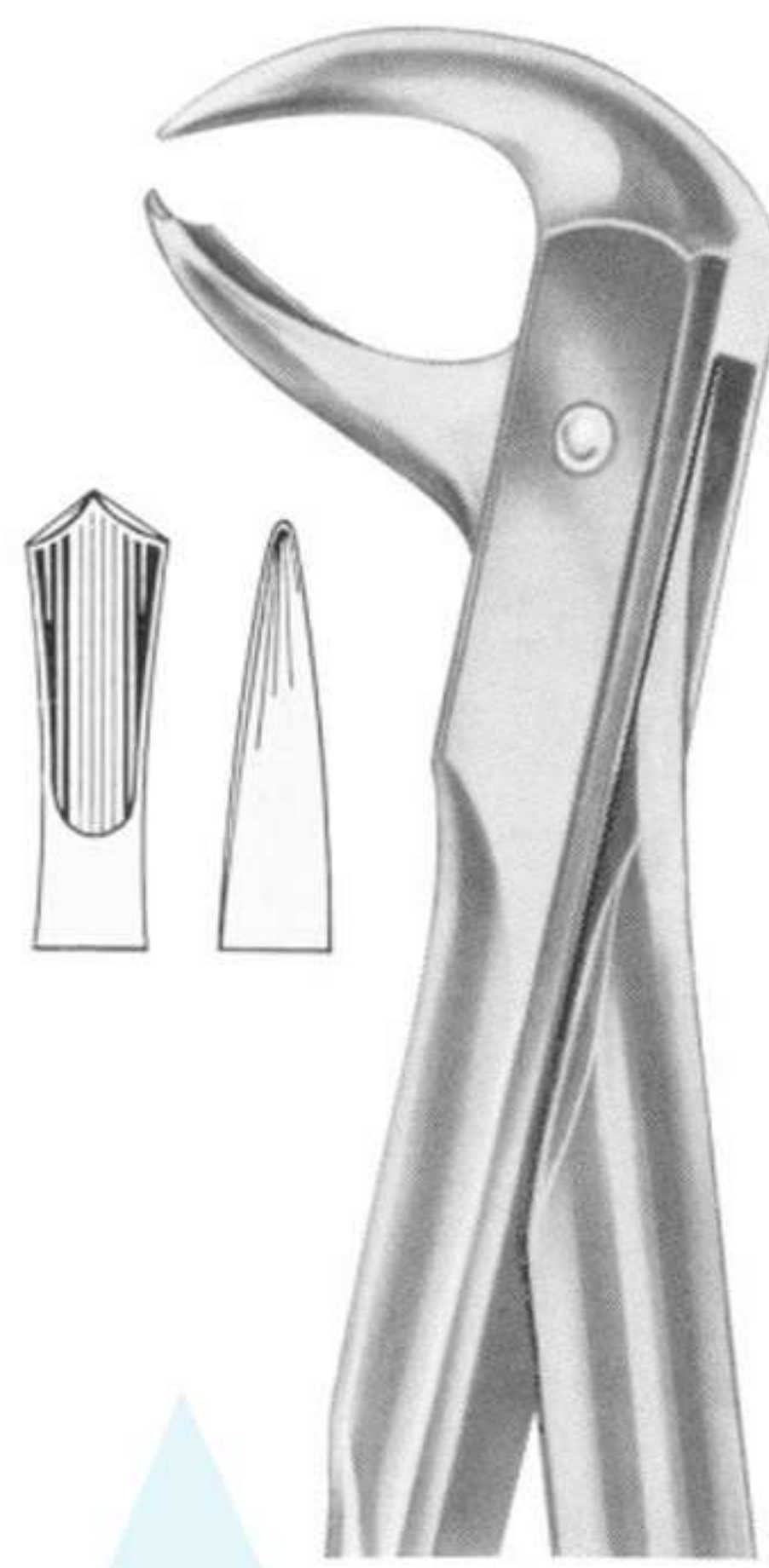

DMI-2-256
Fig. 86C lower molars

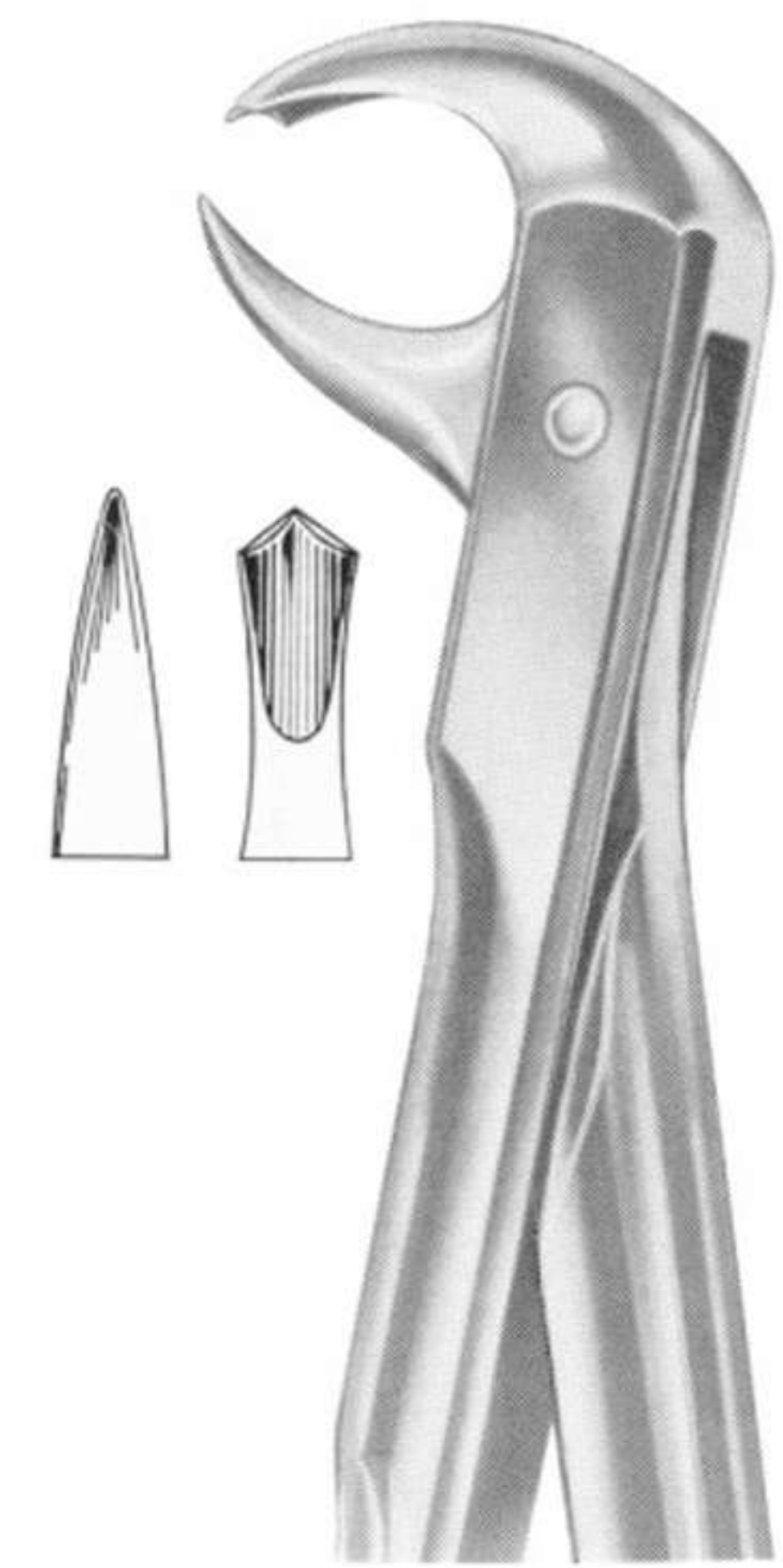

DMI-2-257
Fig. 99 lower molars

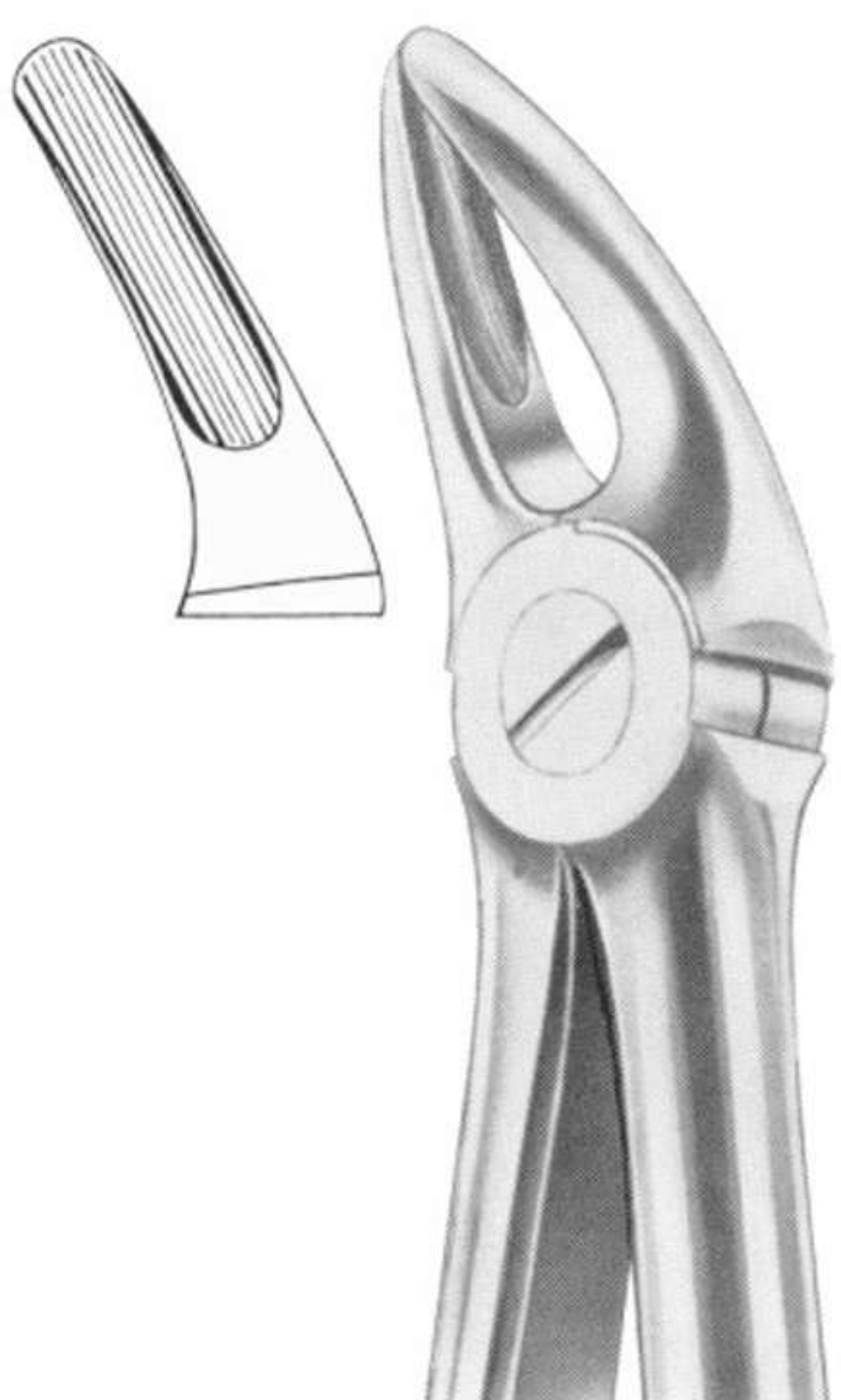

DMI-2-258
Fig. 136 upper premolars
and roots

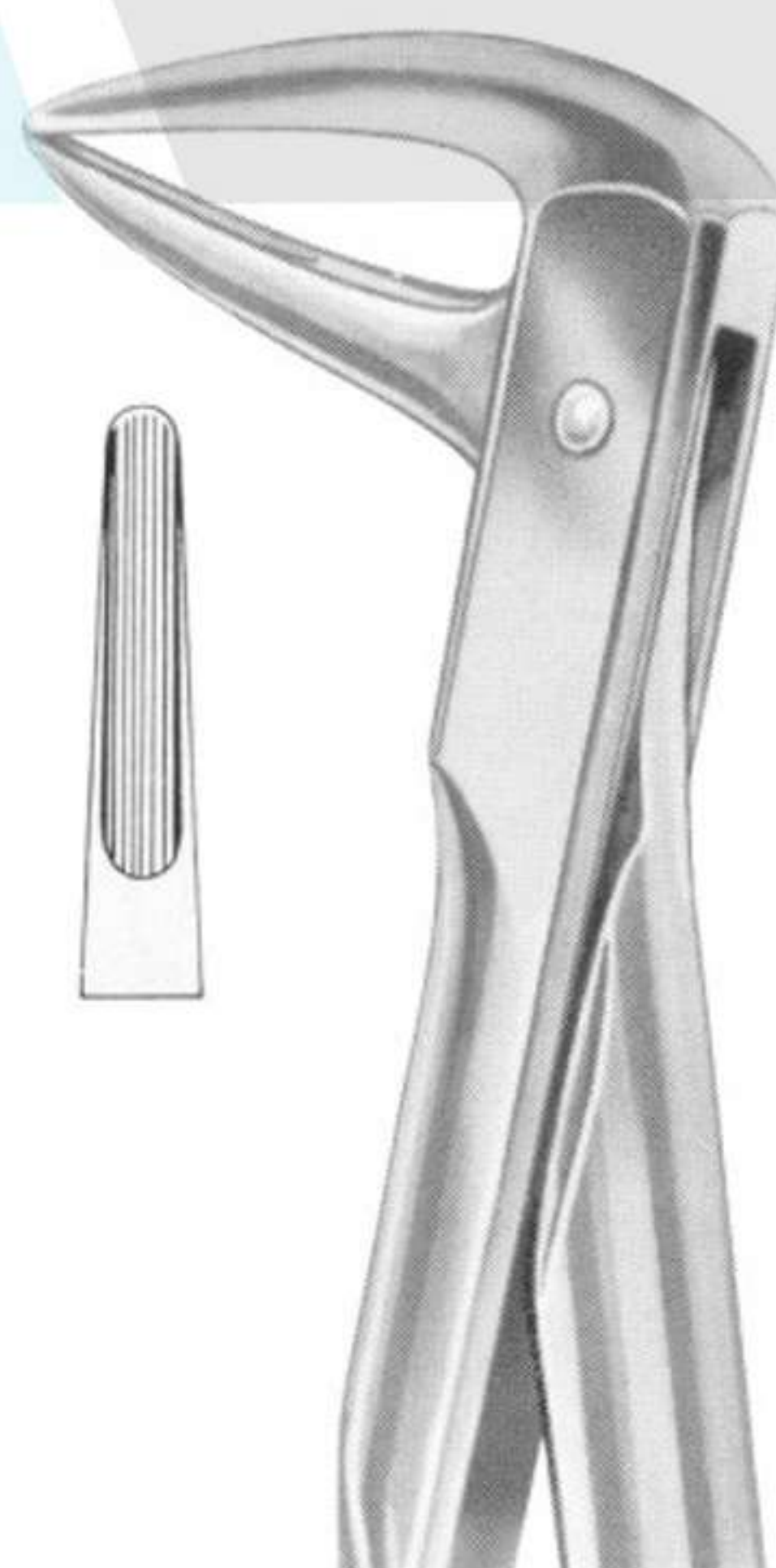

DMI-2-259
Fig. 143 lower roots



DMI-2-260
KLEIN (Fig. 217) upper incisors

Extracting Forceps English Pattern



DMI-2-261
KLEIN (Fig. 218) upper premolars



DMI-2-262
KLEIN (Fig. 219) upper roots

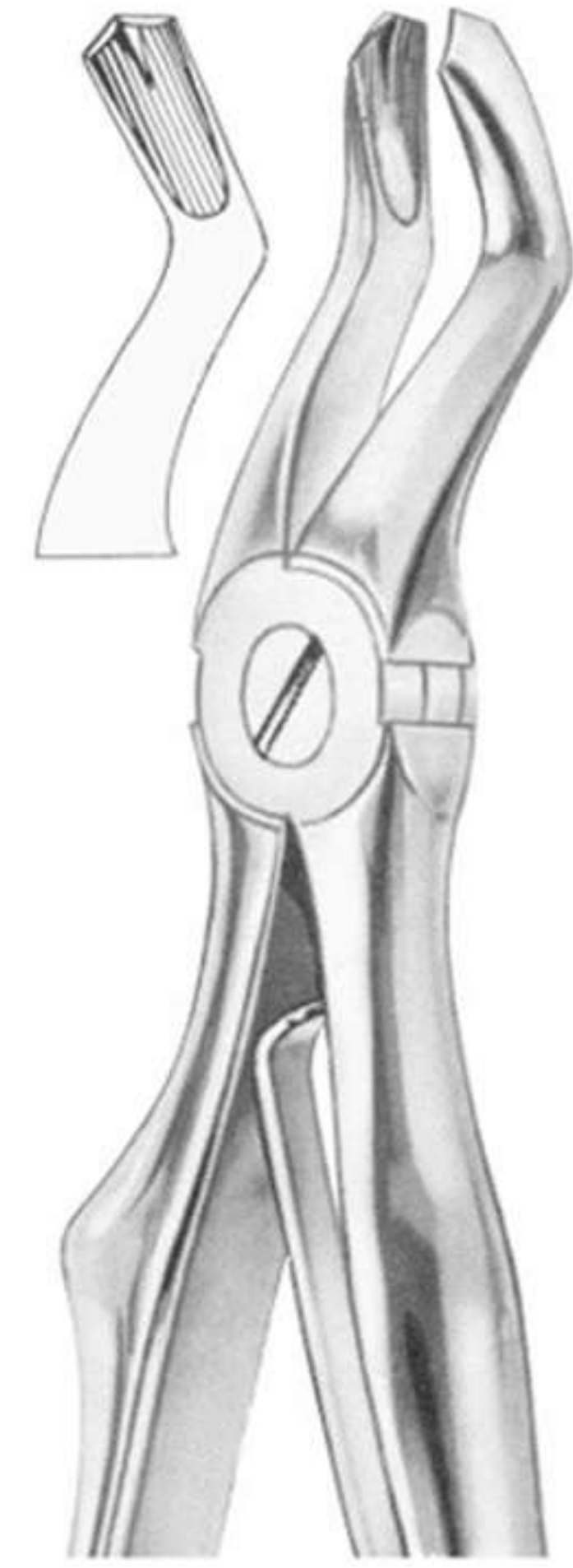

DMI-2-263
KLEIN (Fig. 220) upper molars



DMI-2-264
KLEIN (Fig. 221) lower incisors

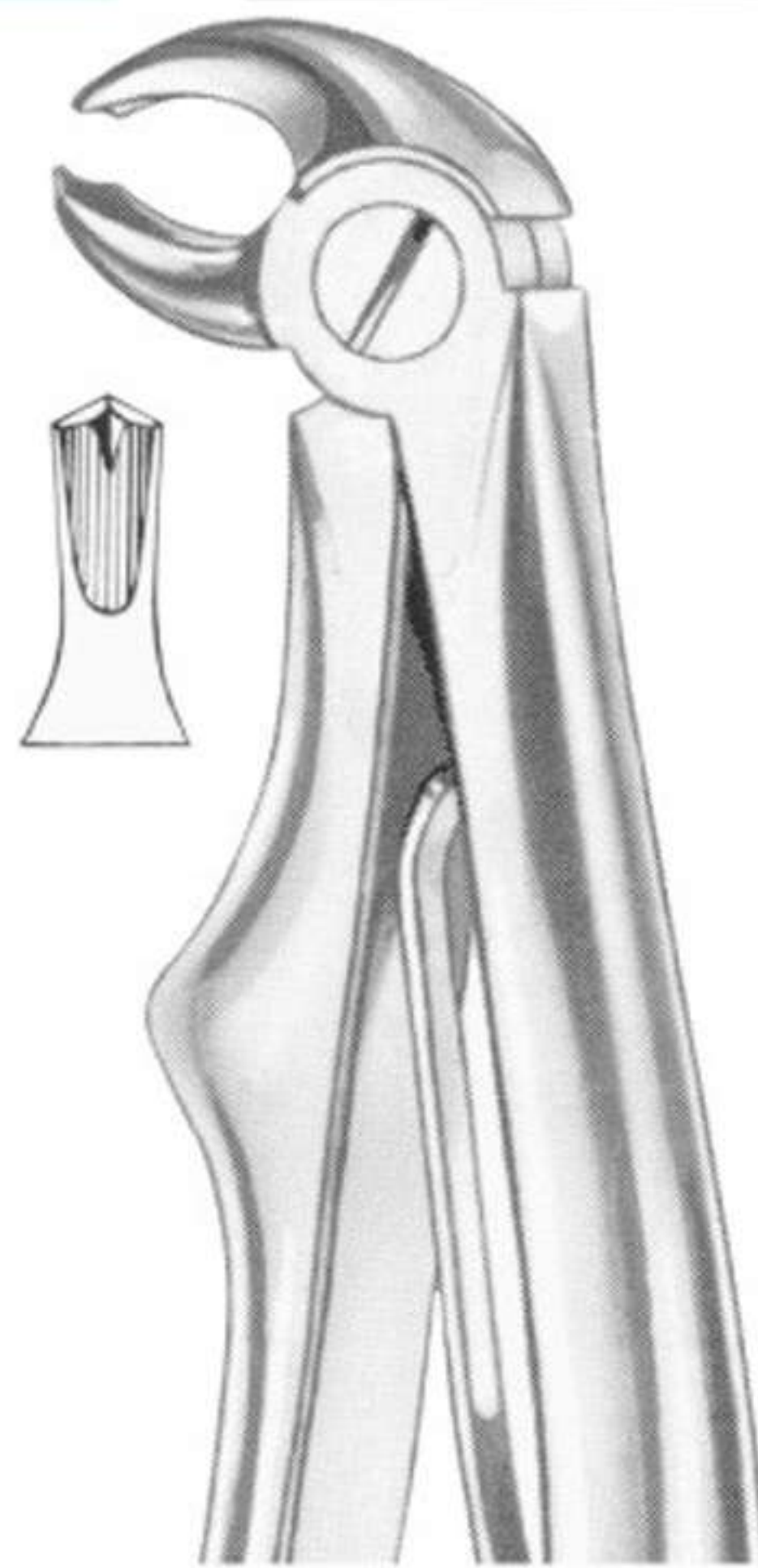

DMI-2-265
KLEIN (Fig. 222) lower molars

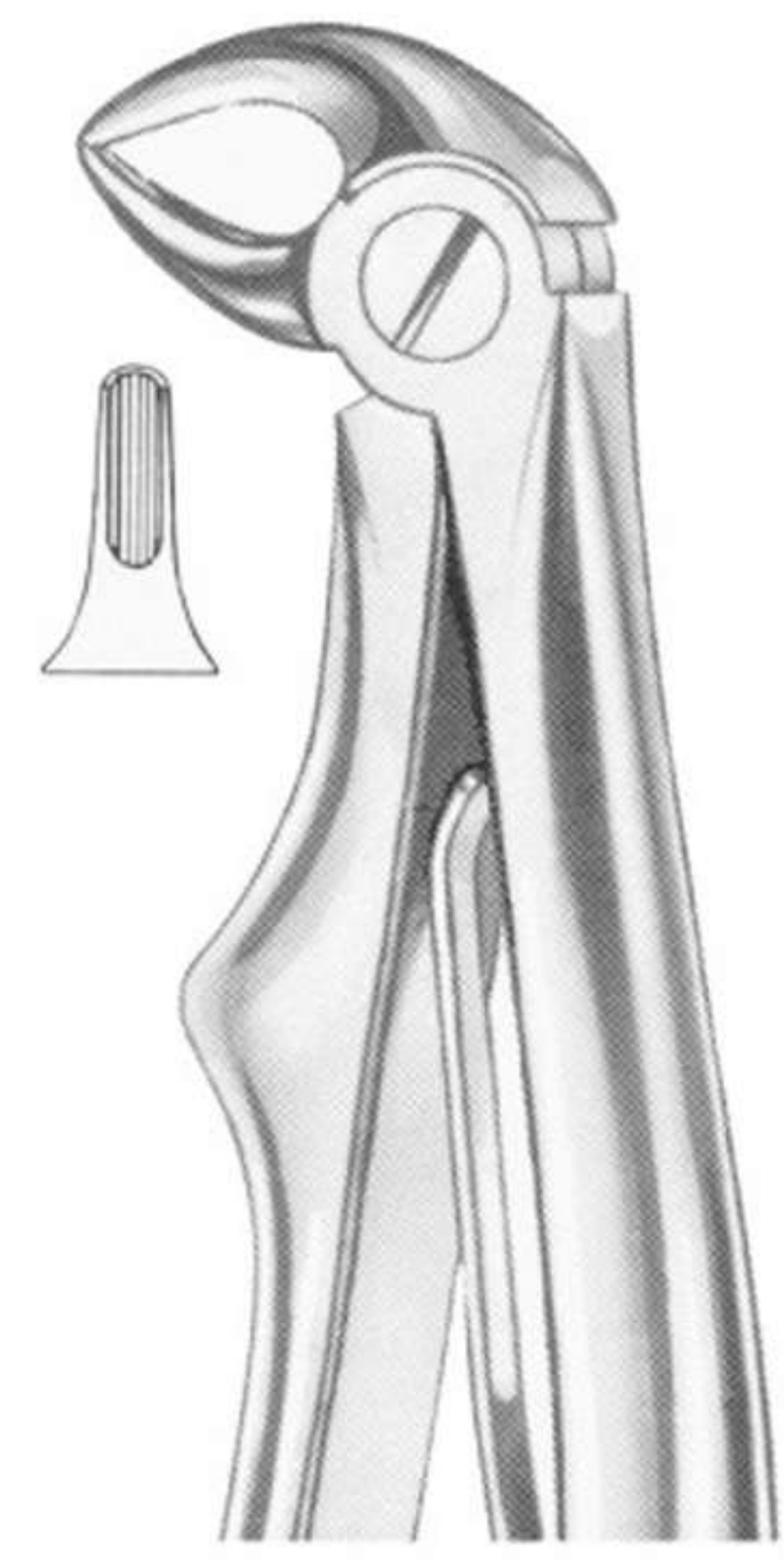

DMI-2-266
KLEIN (Fig. 223) lower roots



DMI-2-267
ALBRECHT Fig. 224 Deciduous



DMI-2-268
ALBRECHT Fig. 225 Deciduous



DMI-2-269
WITZEL Fig. 226 lower roots

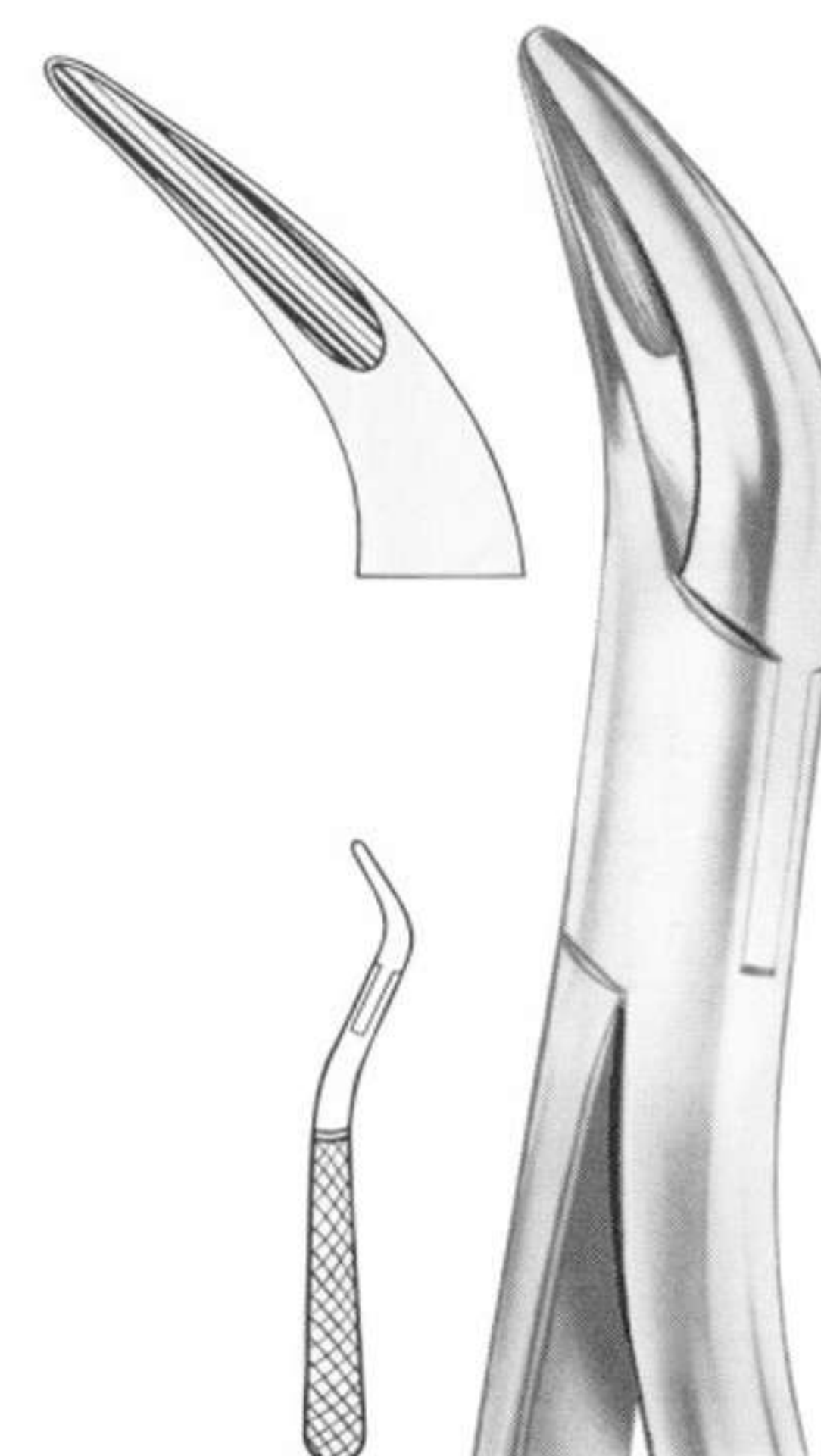

DMI-2-270
WITZEL Fig. 227 upper roots

Elevators



DMI-2-301
DEL 78

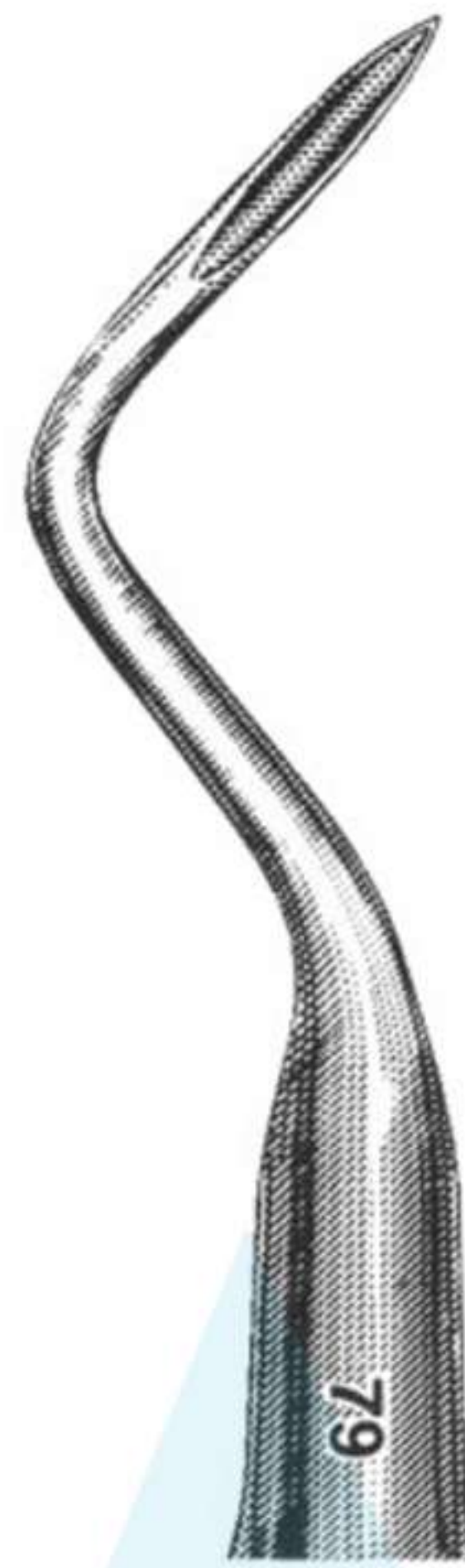

DMI-2-302
DEL 79

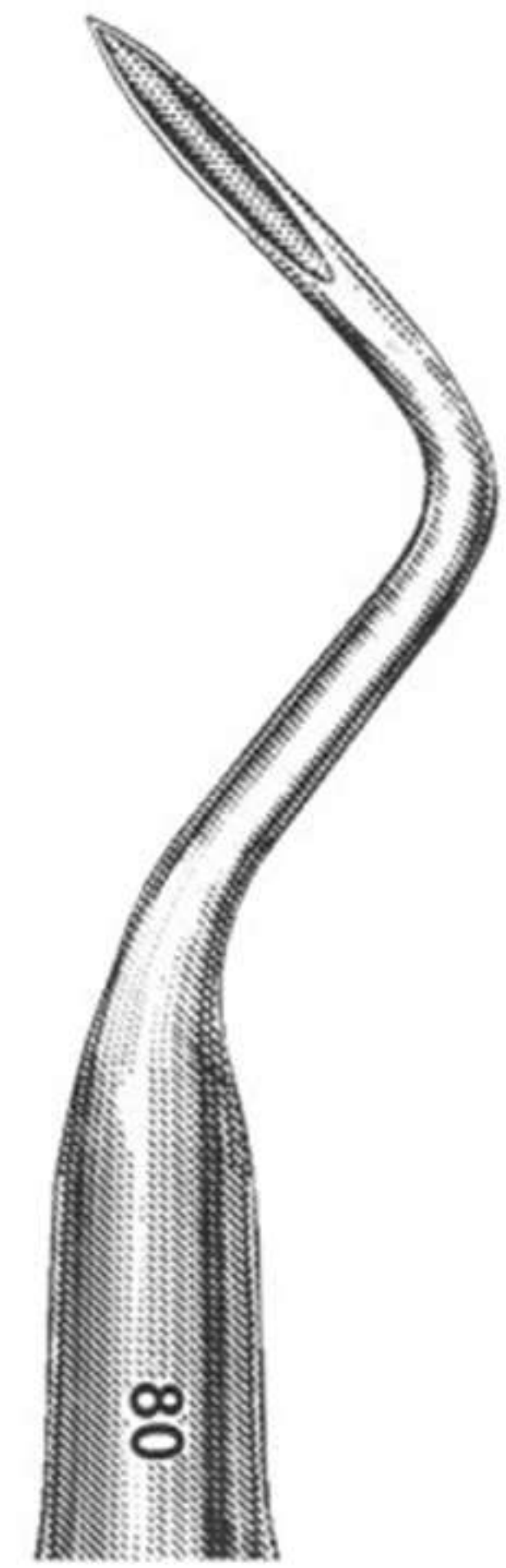

DMI-2-303
DEL 80



DMI-2-304
DEL H1



DMI-2-305
DEL H2



DMI-2-306
DEL H3

Elevators



DMI-2-313
SELDIN

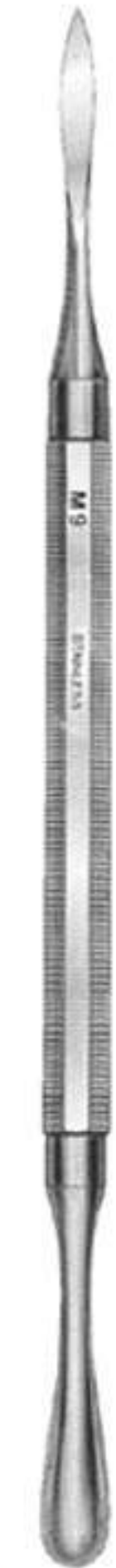

DMI-2-314
MOLT



DMI-2-315
Elevators

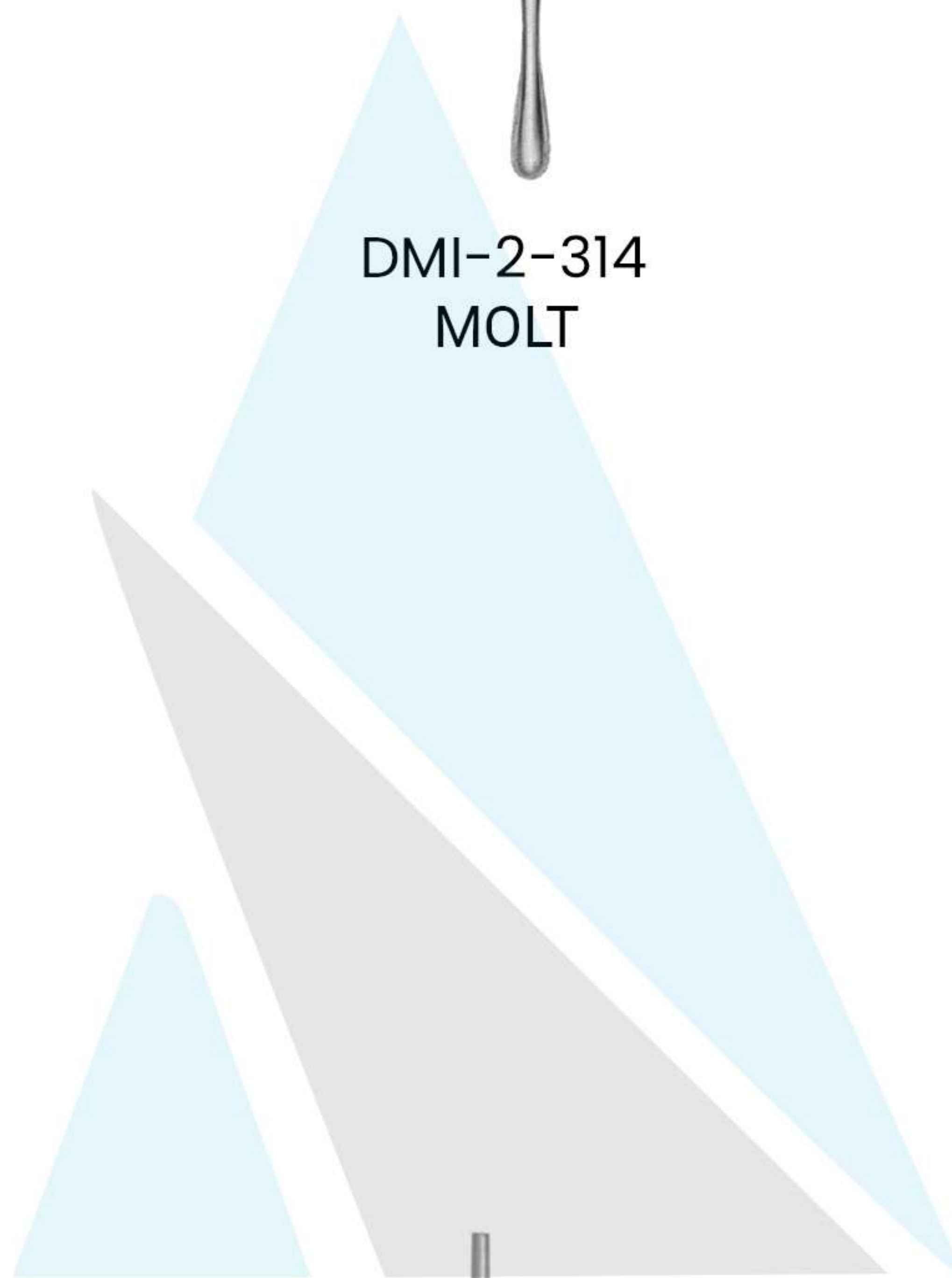

DMI-2-316
Elevators



DMI-2-317
Elevators

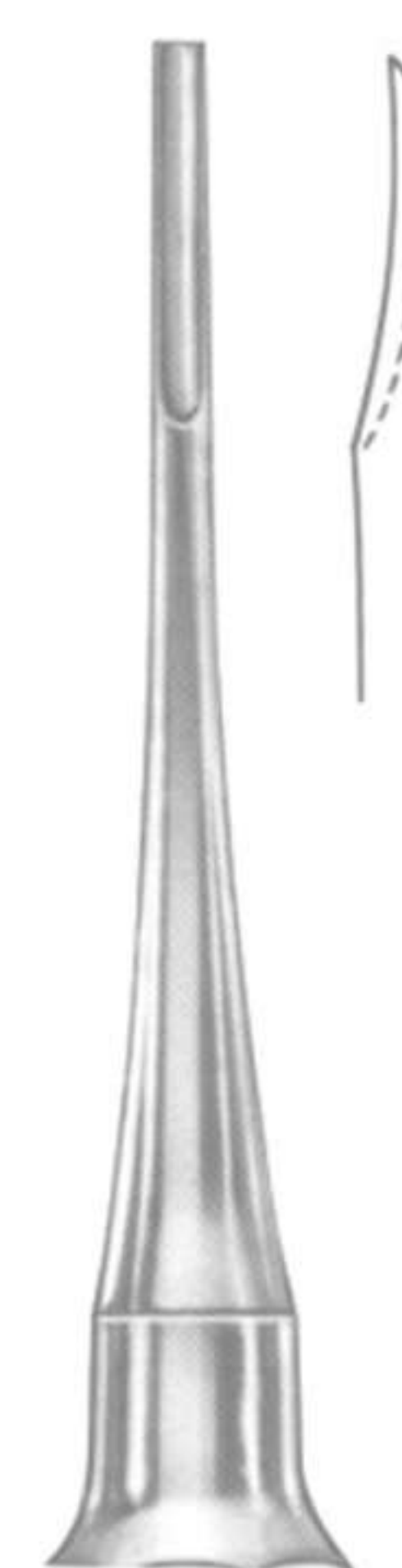

DMI-2-318
ElevatorsBEIN Fig. 1

Elevators

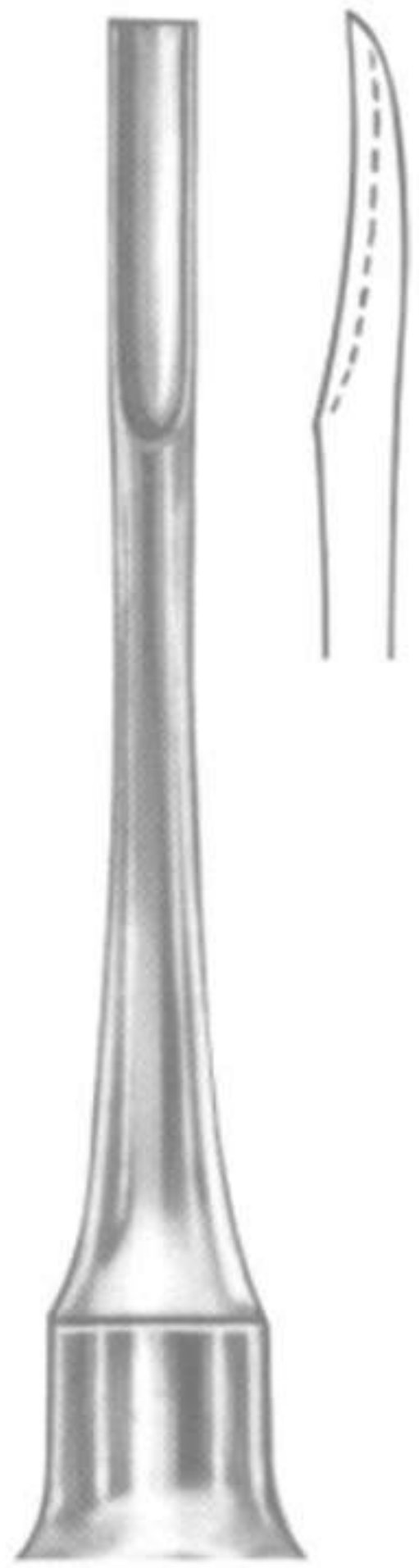

DMI-2-319
BEIN Fig. 2

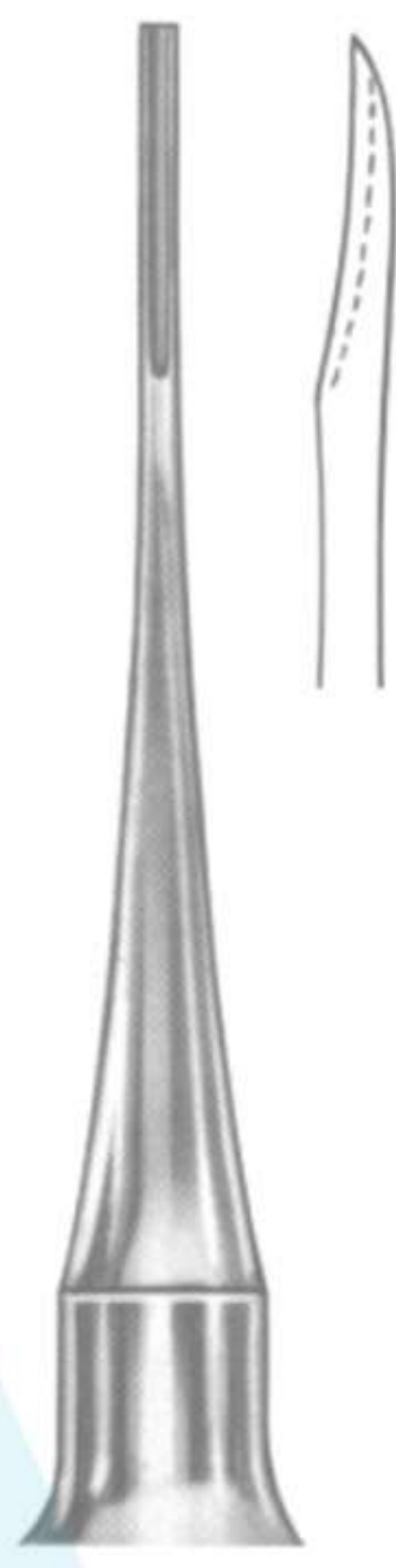

DMI-2-320
BEIN Fig. 0



DMI-2-321
BEIN Fig. 3

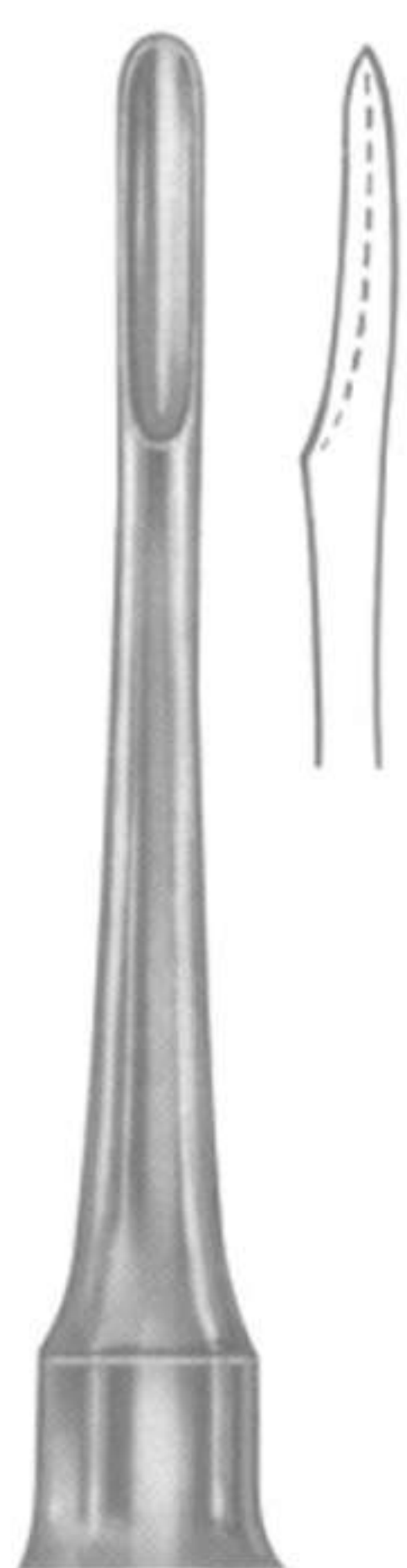
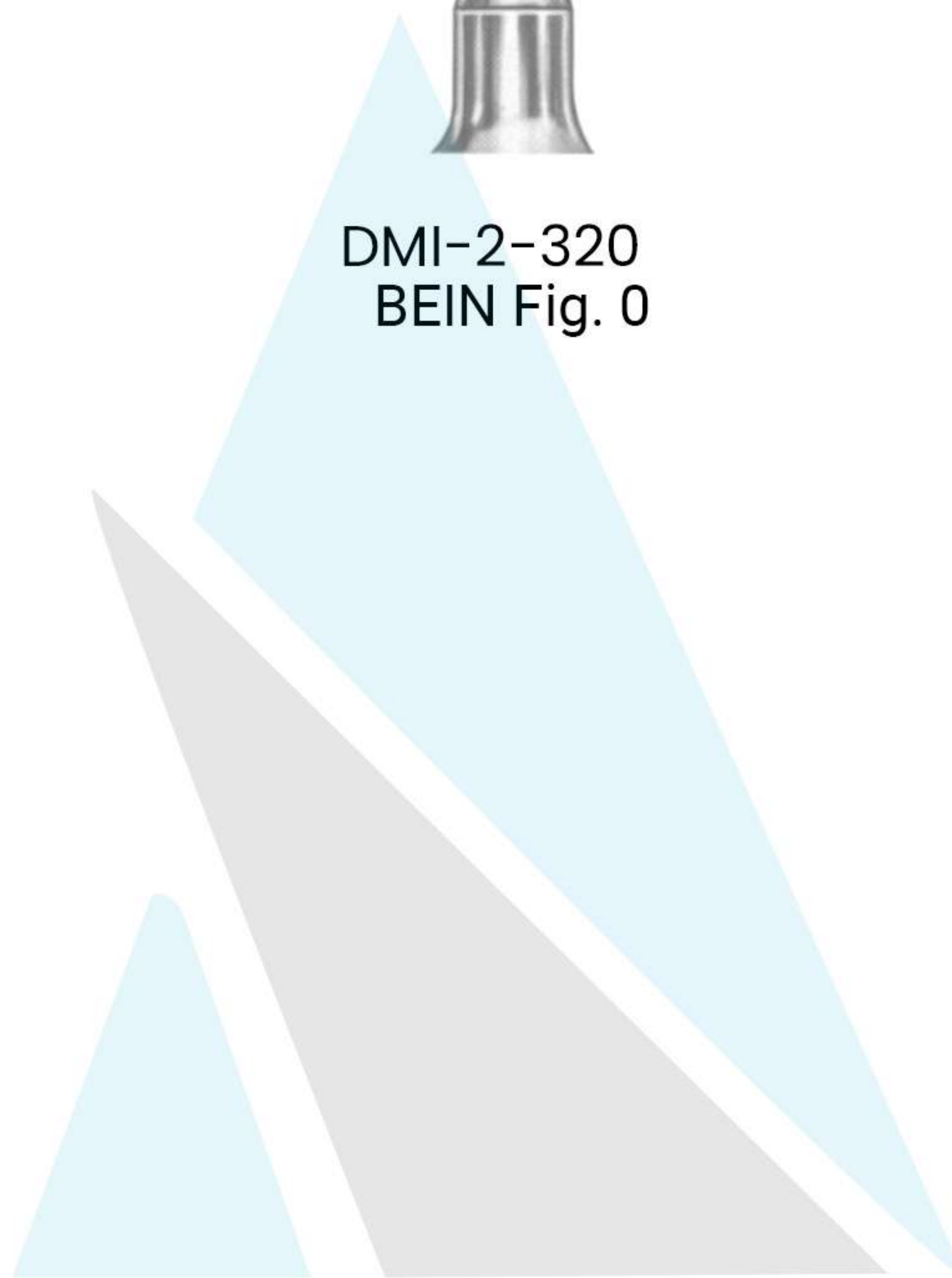

DMI-2-322
BEIN Fig. 4

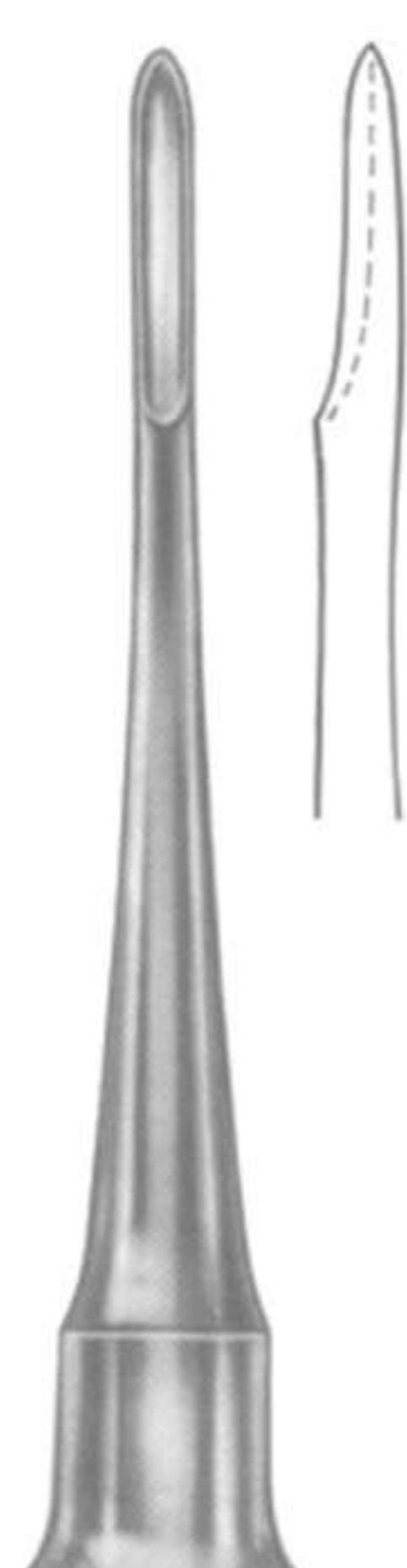

DMI-2-323
BEIN Fig. 5



DMI-2-324
BEIN Fig. 6

Elevators



DMI-2-325
SELDIN



DMI-2-326
SELDIN Fig. 1L



DMI-2-327
SELDIN Fig. 1R

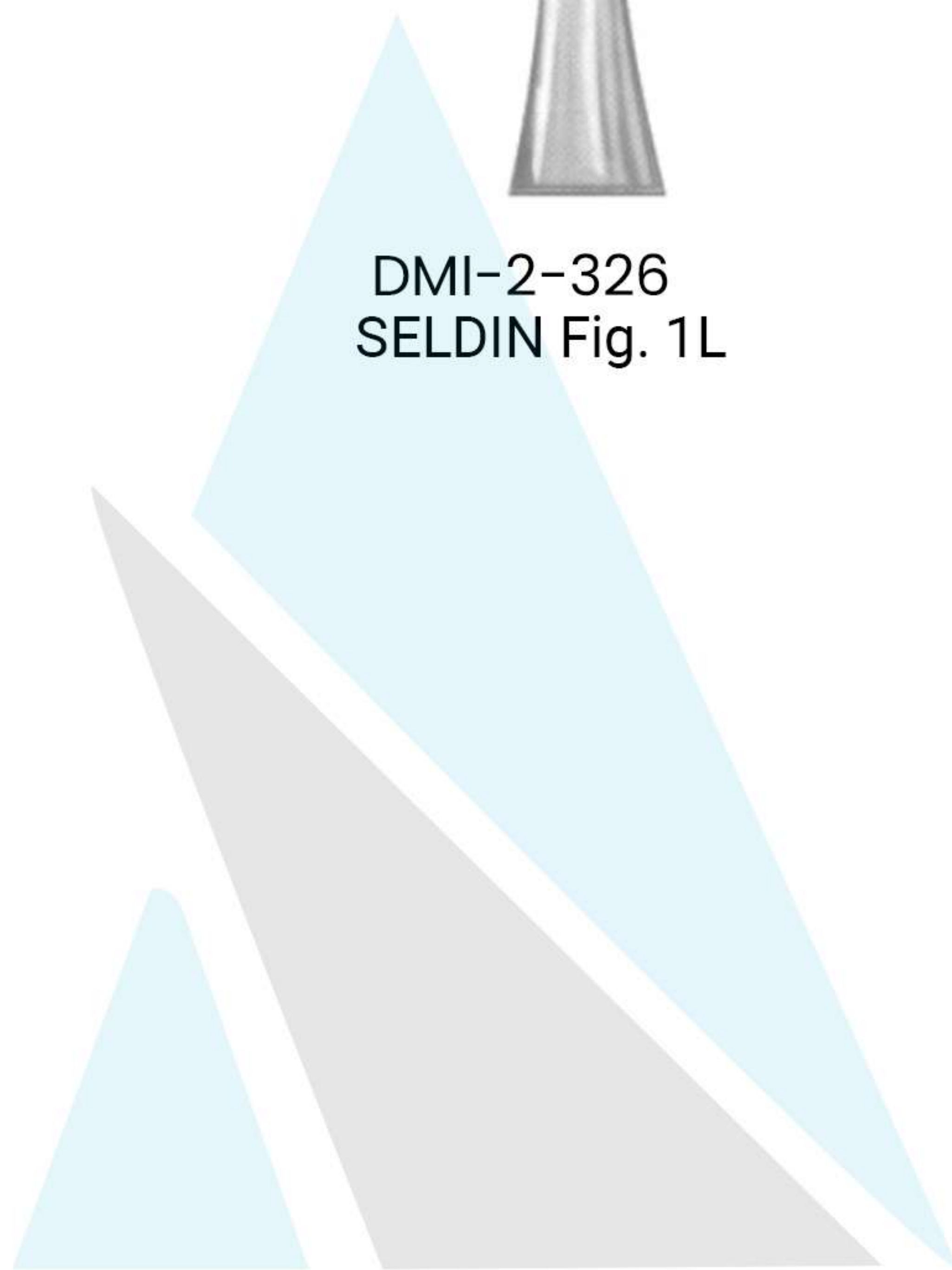

DMI-2-328
SELDIN Fig. 2



DMI-2-329
SELDIN Fig. 3



DMI-2-330
SELDIN Fig. 4L

Elevators



DMI-2-331
SELDIN Fig. 4R



DMI-2-332
CRYER Fig. 3



DMI-2-333
CRYER Fig. 4



DMI-2-334
CRYER Fig. 12



DMI-2-335
CRYER Fig. 27



DMI-2-336
CRYER Fig. 28

Elevators



DMI-2-337
CRYER Fig. 27S



DMI-2-338
IS-APICAL



DMI-2-339
APICAL Fig. 1

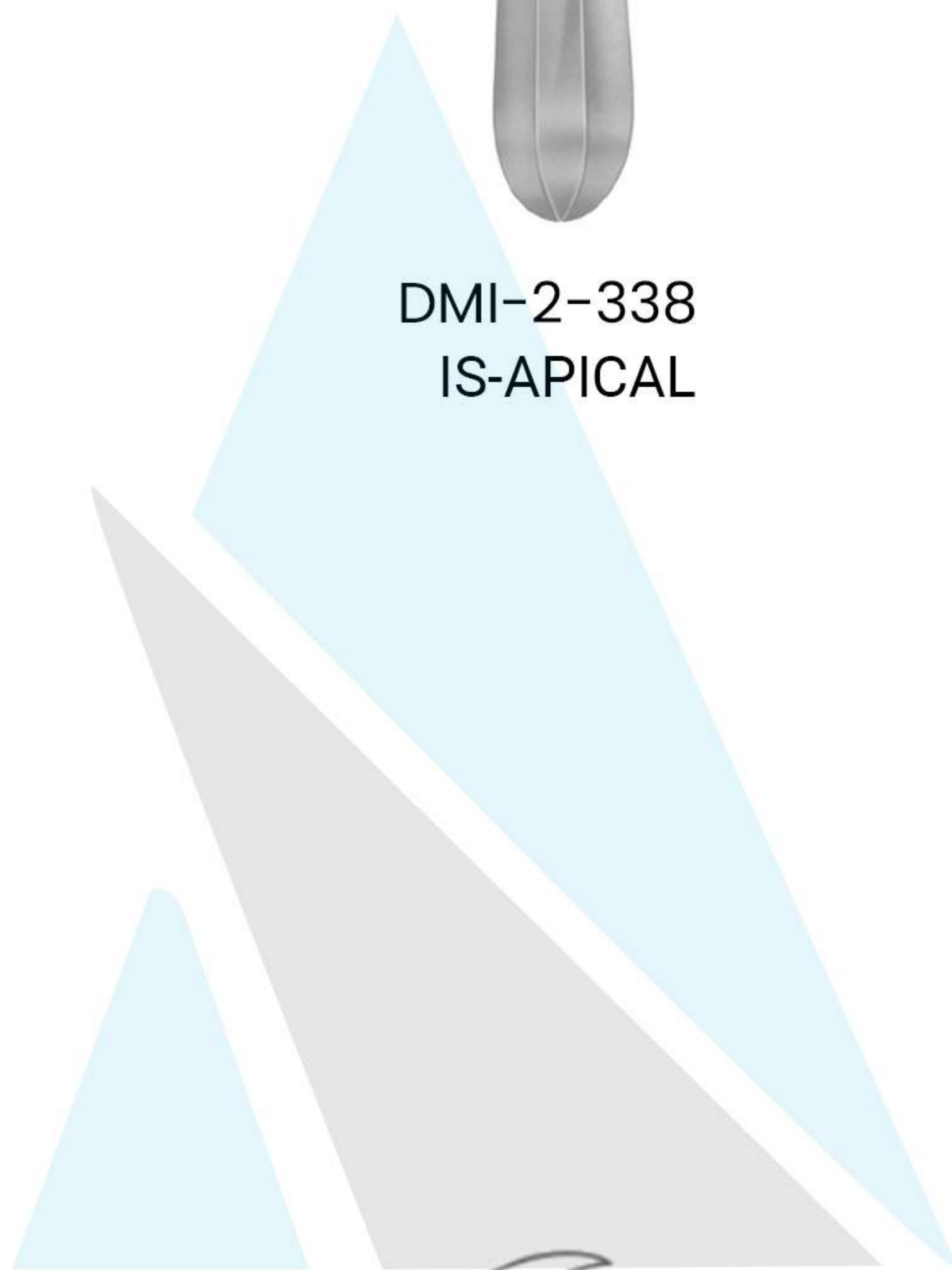

DMI-2-340
APICAL Fig. 2



DMI-2-341
APICAL Fig. 3



DMI-2-342
APICAL Fig. 4

Elevators



DMI-2-349
Fig. 1

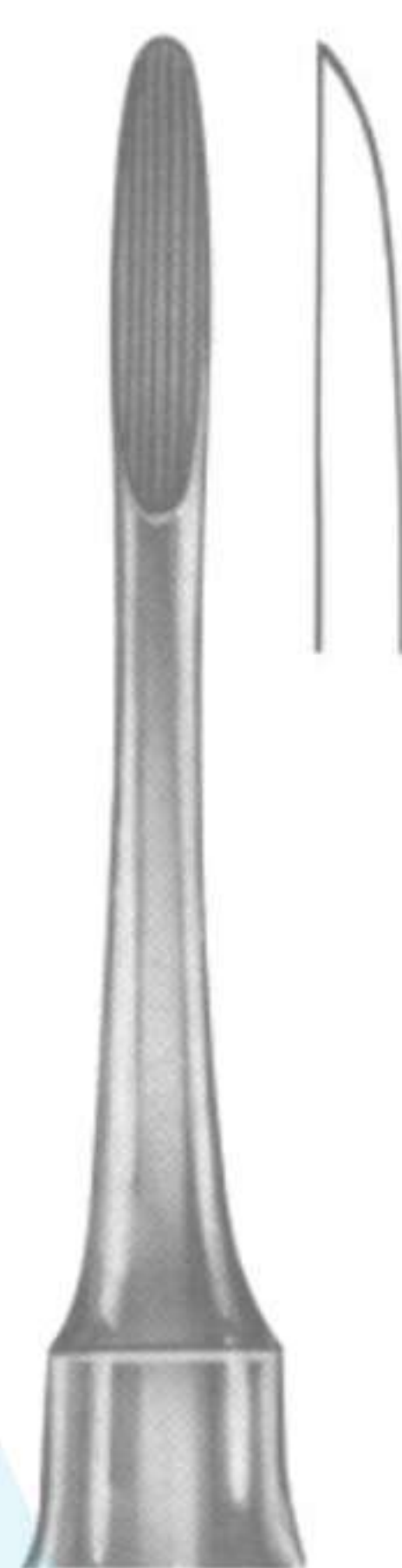

DMI-2-350
Fig. 3



DMI-2-351
FLOHR Fig. 1

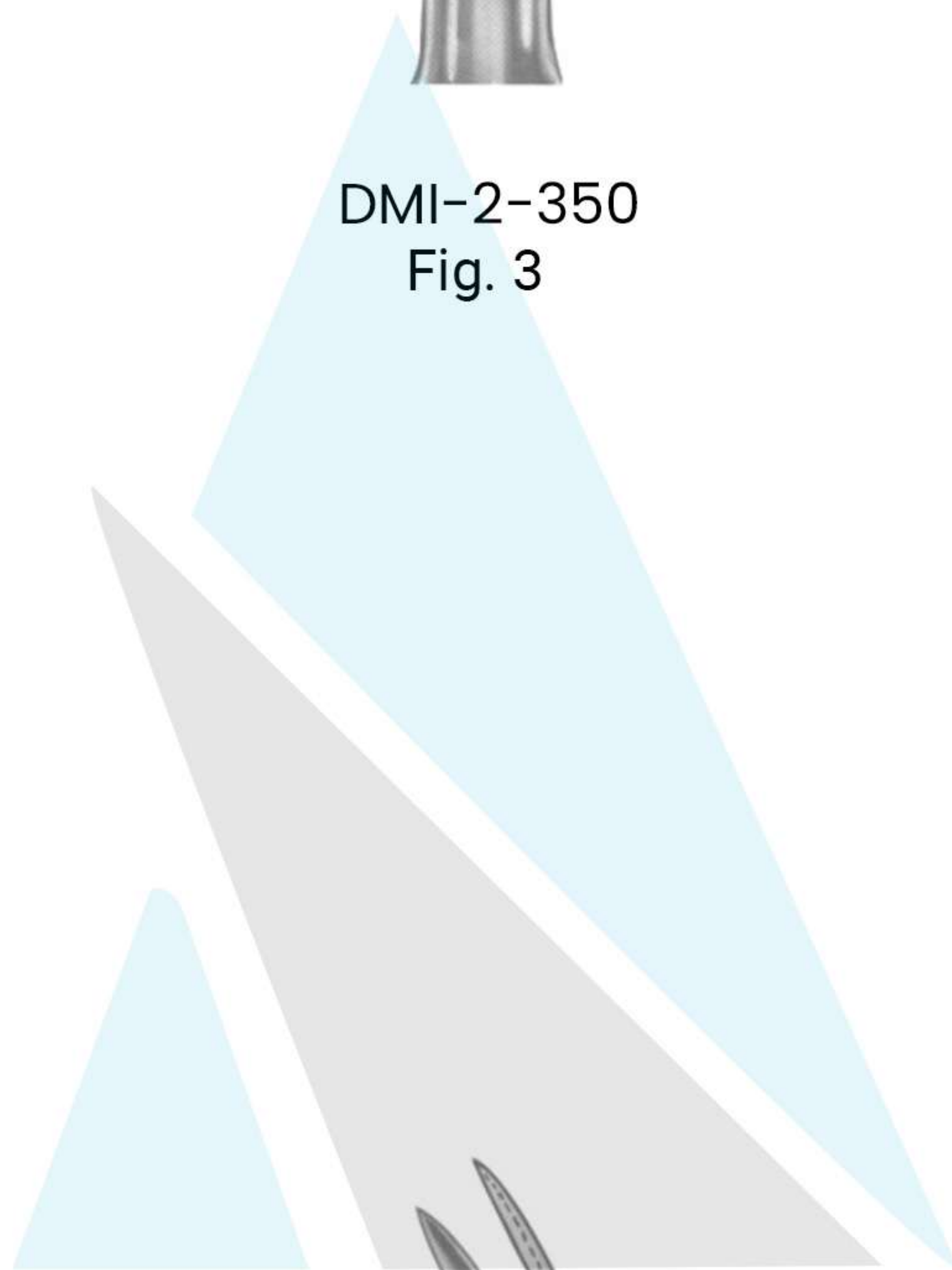

DMI-2-352
FLOHR Fig. 2



DMI-2-353
FLOHR Fig. 3



DMI-2-354
KOPP

Elevators



DMI-2-355
KOPP Fig. 2



DMI-2-356
Elevators



DMI-2-357
KOPP Fig. 5

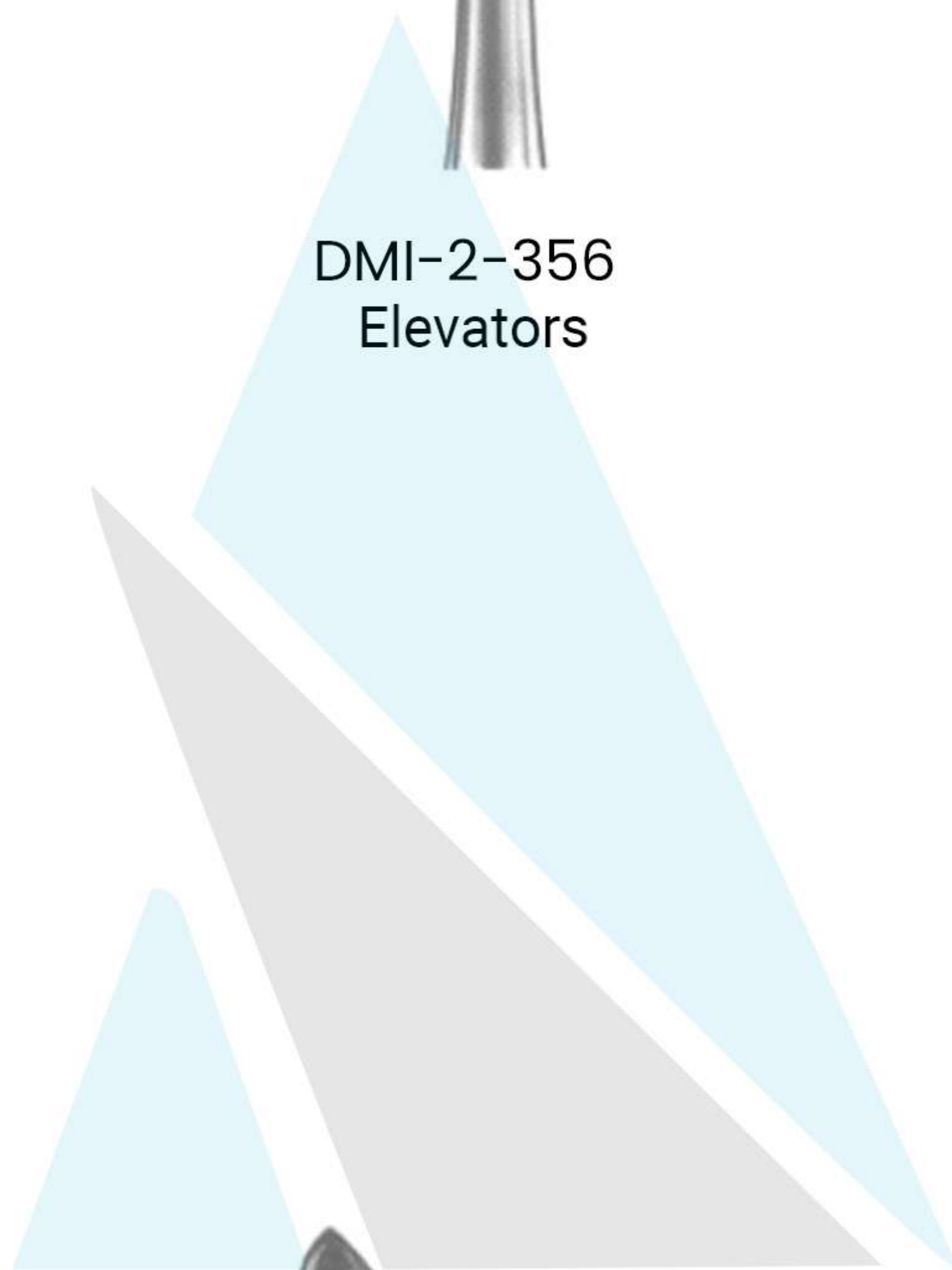

DMI-2-358
KOPP Fig. 1



DMI-2-359
KOPP Fig. 2



DMI-2-360
KOPP Fig. 3

Elevators



DMI-2-361
KOPP Fig. 4



DMI-2-362
HYLIN

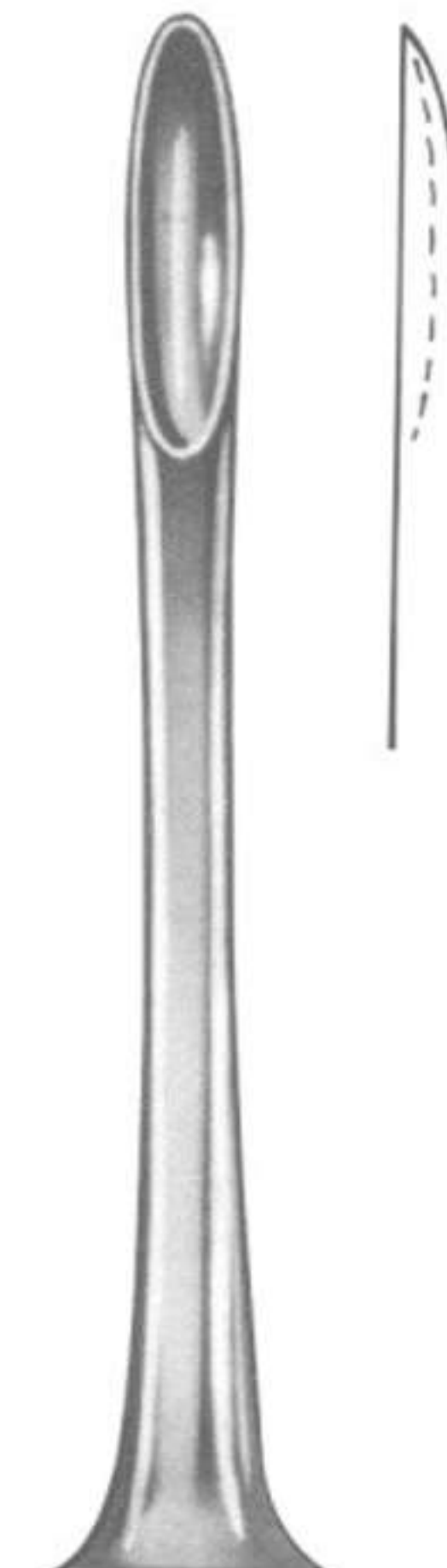

DMI-2-363
HYLIN Fig. 1

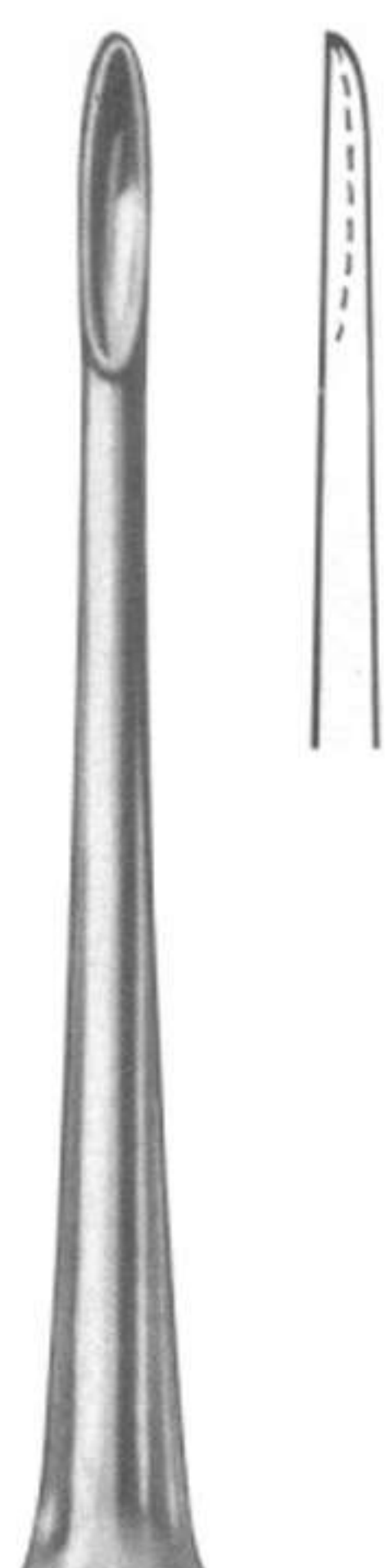

DMI-2-363
HYLIN Fig. 2



DMI-2-364
BEIN

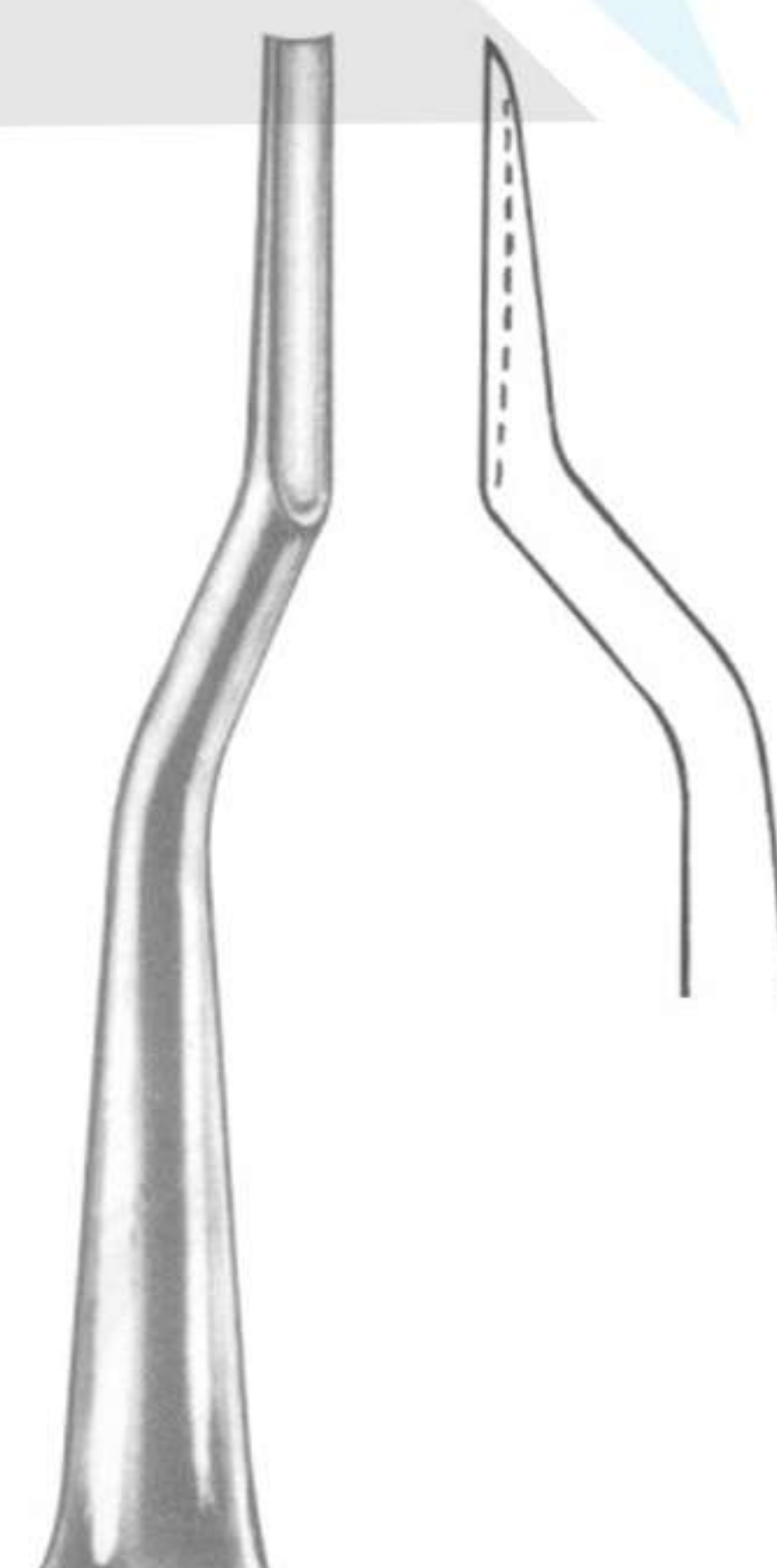

DMI-2-365
BEIN Fig. 1

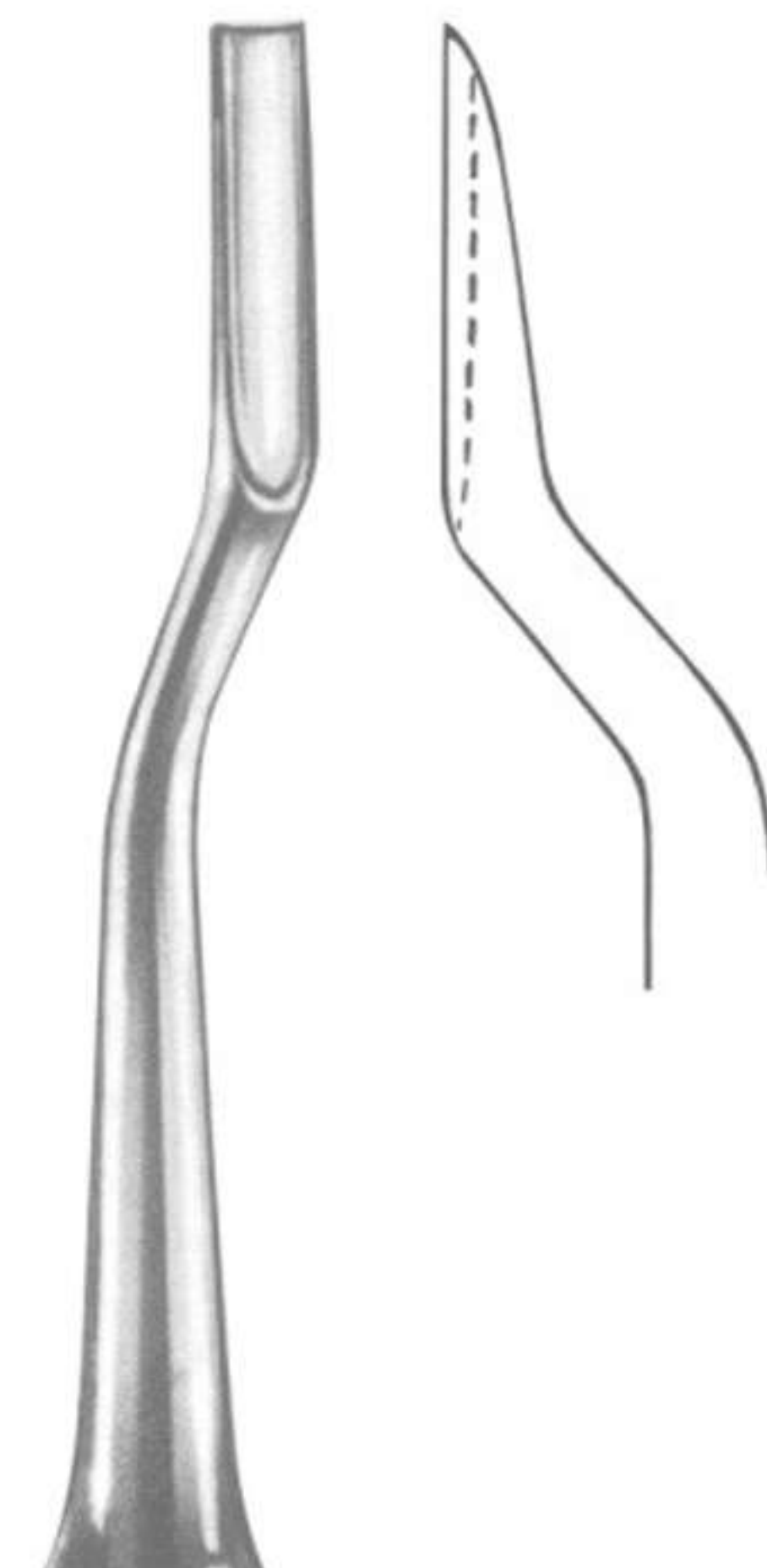

DMI-2-366
BEIN Fig. 2

**Endodontic Condensers,
Obturation Instruments Excavators,Probe**



DMI-2-401
TF13 Root Canal 1-3



DMI-2-402
UF30 *ISO-30



DMI-2-403
UF40 *ISO-40 (8)



DMI-2-404
UF50 *ISO-50 (7)



DMI-2-405
UF65 *ISO-65



DMI-2-406
UF80 *ISO-80

**Endodontic Condensers,
Obturation Instruments Excavators, Probes**



DMI-2-407
UF90 *ISO-90



DMI-2-408
UF110 *ISO-110



DMI-2-409
UF60 *ISO-60

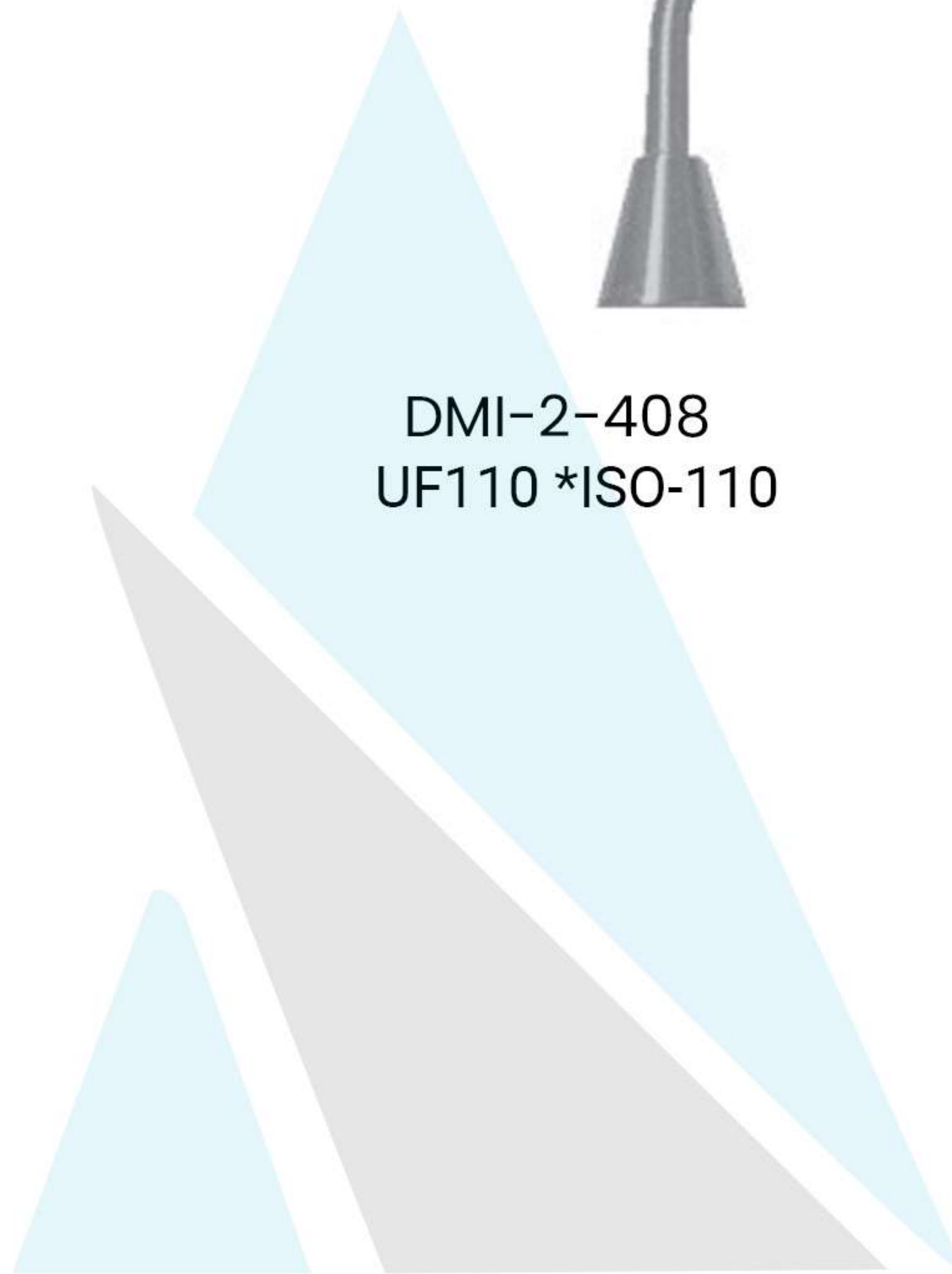

DMI-2-410
TF911 Root Canal 9-11



DMI-2-411
GNI-2-411



DMI-2-412
UF45 *ISO-45

**Endodontic Condensers,
Obturation Instruments Excavators, Probes**



DMI-2-413
UF55 *ISO-55 (9)



DMI-2-414
UF70 *ISO-70



DMI-2-415
UF85 *ISO-85

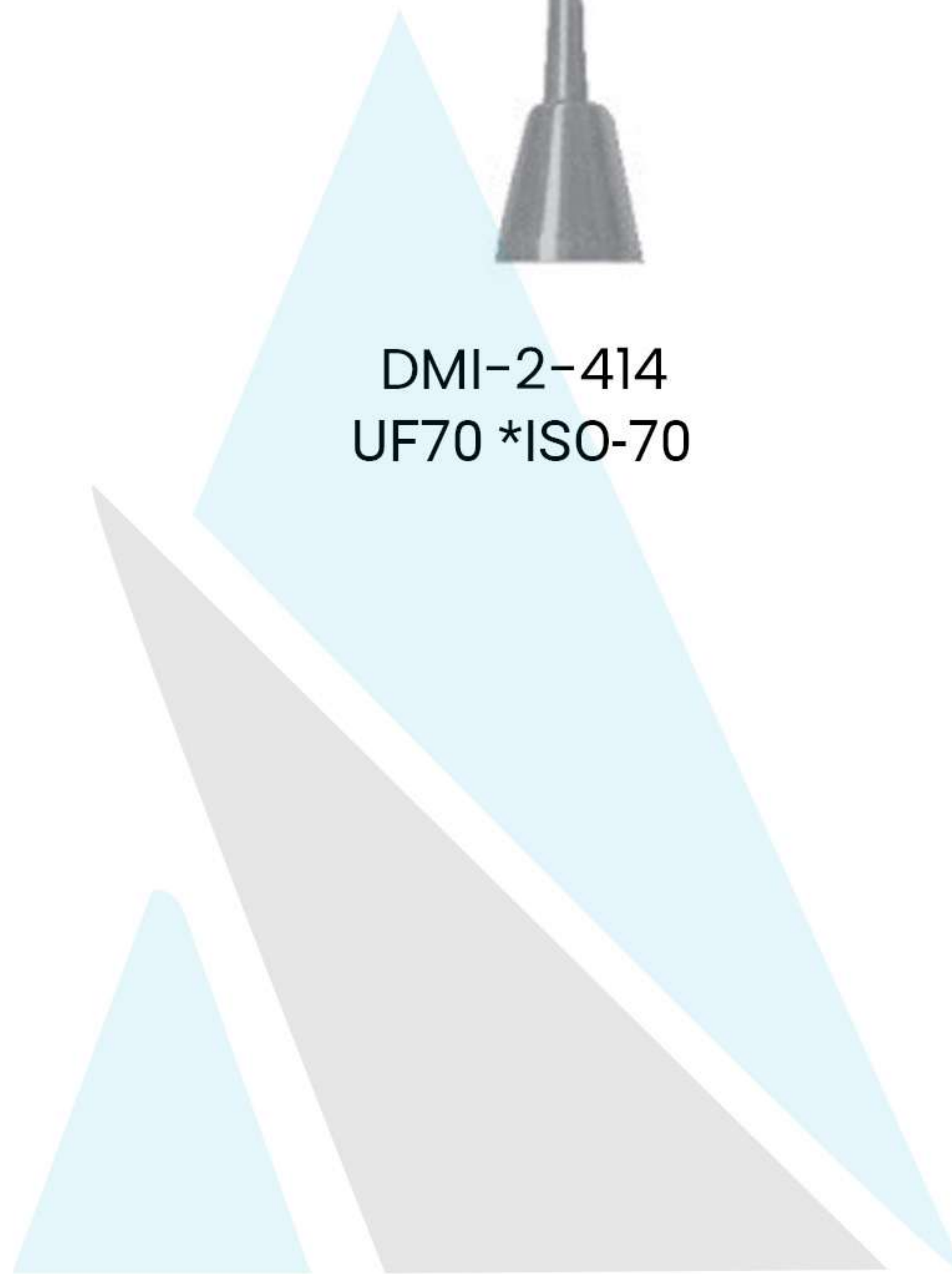

DMI-2-416
UF110 *ISO-130



DMI-2-417
UF120X



DMI-2-418
UF45N

**Endodontic Condensers,
Obturation Instruments Excavators, Probes**



DMI-2-419
UF60N



DMI-2-420
UF80N



DMI-2-421
UF100X



DMI-2-422
UE25 R-25



DMI-2-423
UE30 R-30



DMI-2-424
UE35 R-35

**Endodontic Condensers,
Obturation Instruments Excavators, Probes**



DMI-2-425
UE40 R-40



DMI-2-426
UE45 R-45



DMI-2-427
UE50 R-50

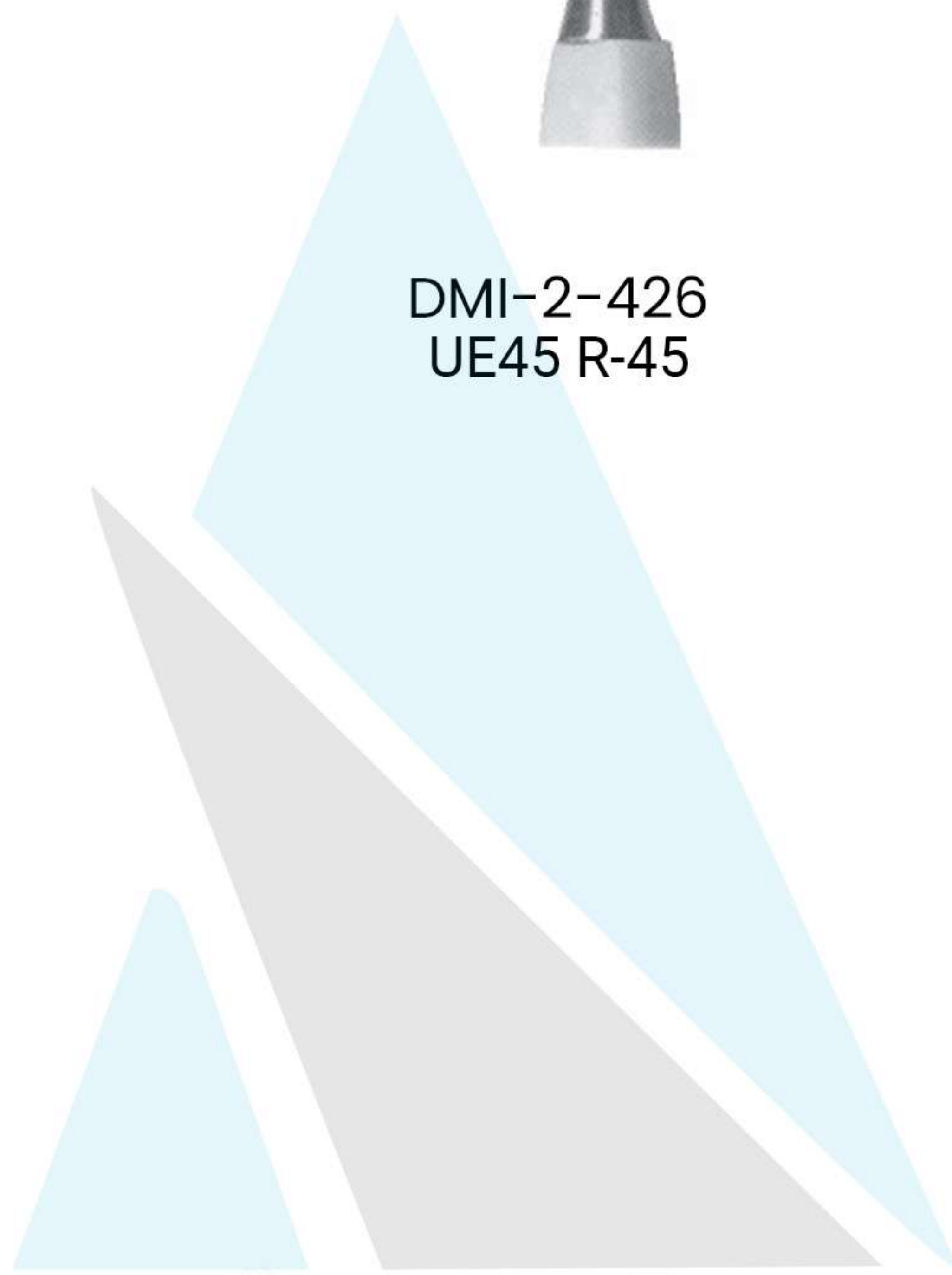

DMI-2-428
UF120X



DMI-2-429
UF140X



DMI-2-430
TFD3545N

**Endodontic Condensers,
Obturation Instruments Excavators, Probes**



DMI-2-431
TFD6080N



DMI-2-432
UE55 R-55



DMI-2-433
UE60 R-60



DMI-2-434
UE30N R-30



DMI-2-435
UE40N R-40



DMI-2-436
D1 .33mm, D16 .95mm

**Endodontic Condensers,
Obturation Instruments Excavators, Probes**



DMI-2-443
Lucks No.1



DMI-2-444
Lucks No.2



DMI-2-445
Lucks No.3

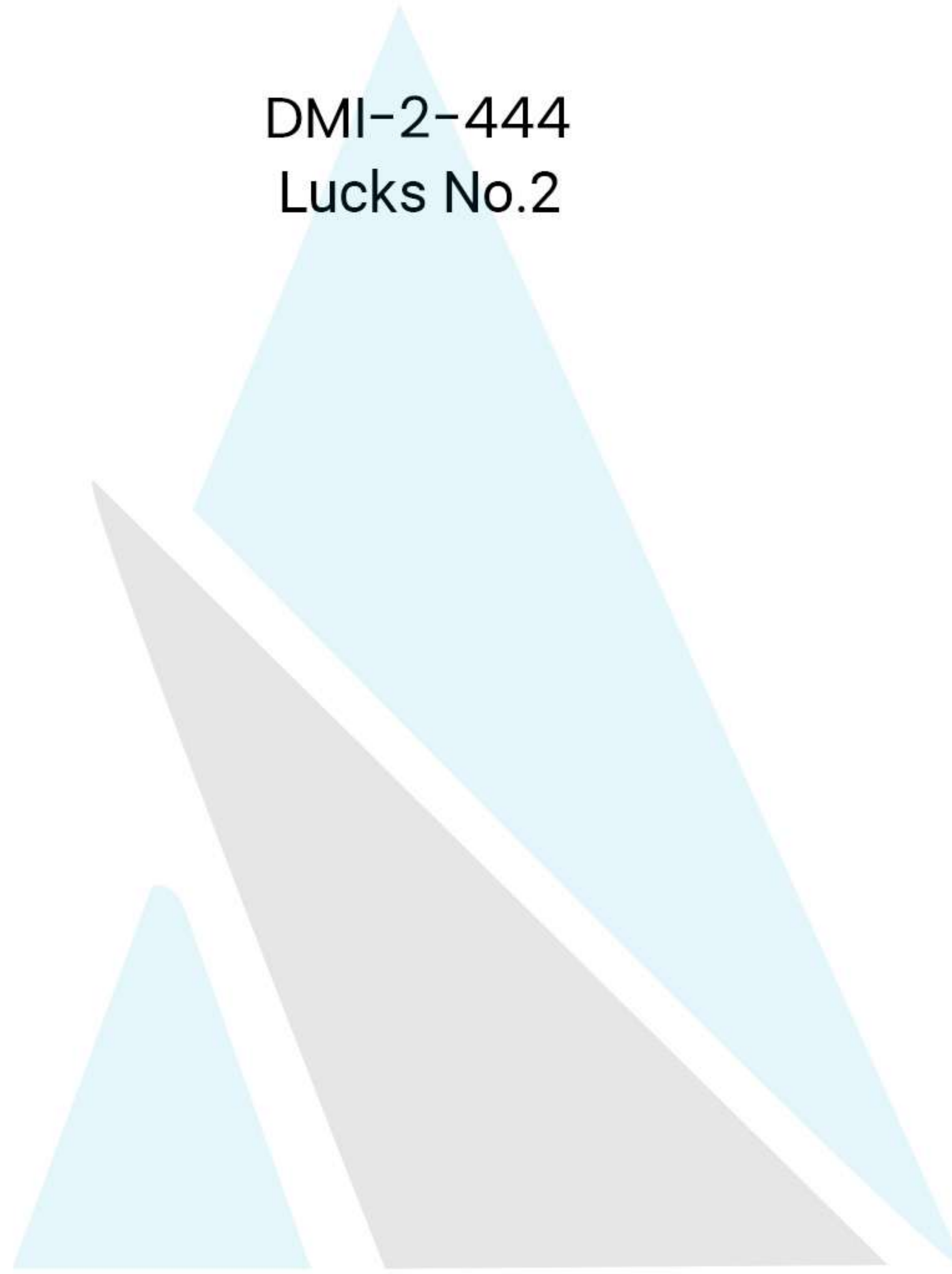

DMI-2-446
Lucks No.4

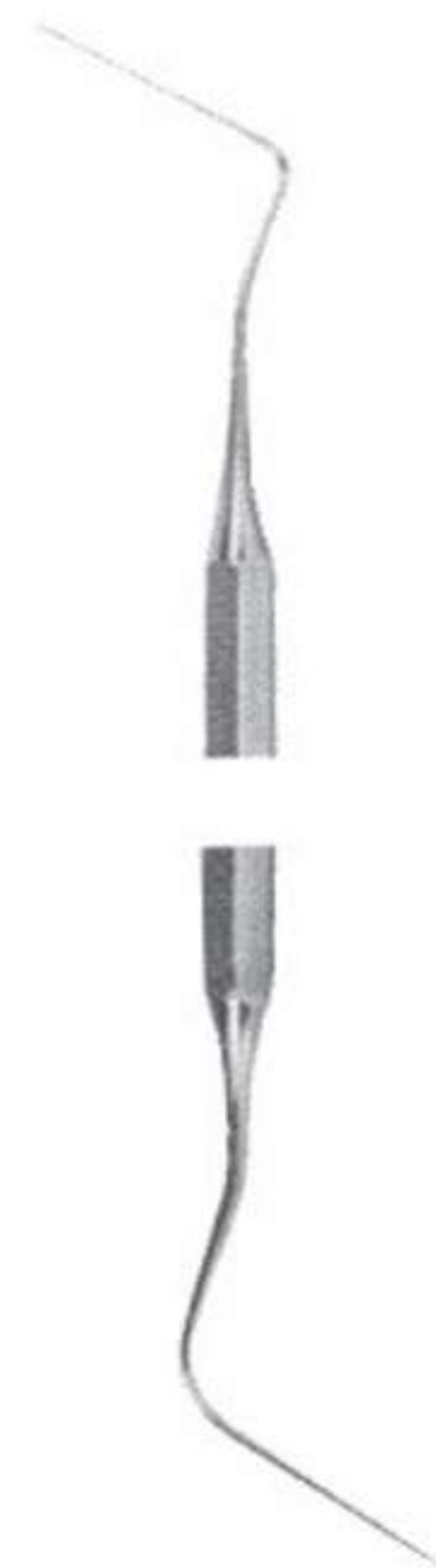

DMI-2-447
D(1mm).50mm, .55mm D(5mm)
D(16mm), 85mm, .75mm D(16mm)



DMI-2-448
D(1mm).70mm, .50mm D(5mm)
D(16mm), 1.00mm, .75mm D(16mm)

**Endodontic Condensers,
Obturation Instruments Excavators, Probes**



DMI-2-449
D(1mm)1.00mm, .63mm D
(5mm)D(16mm), 1.30mm, .
75mm D(16mm)

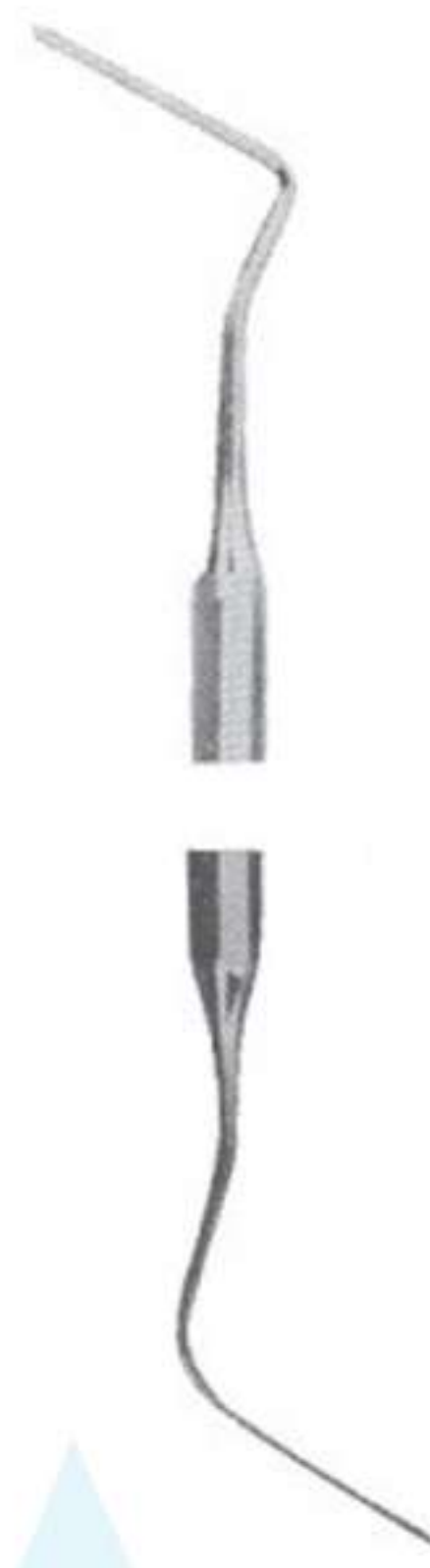

DMI-2-450
D(1mm)1.20mm, .63mm D
(5mm) D(16mm), 1.50mm, .
75mm D(16mm)



DMI-2-451
(D1 .35mm, D16 .75mm)

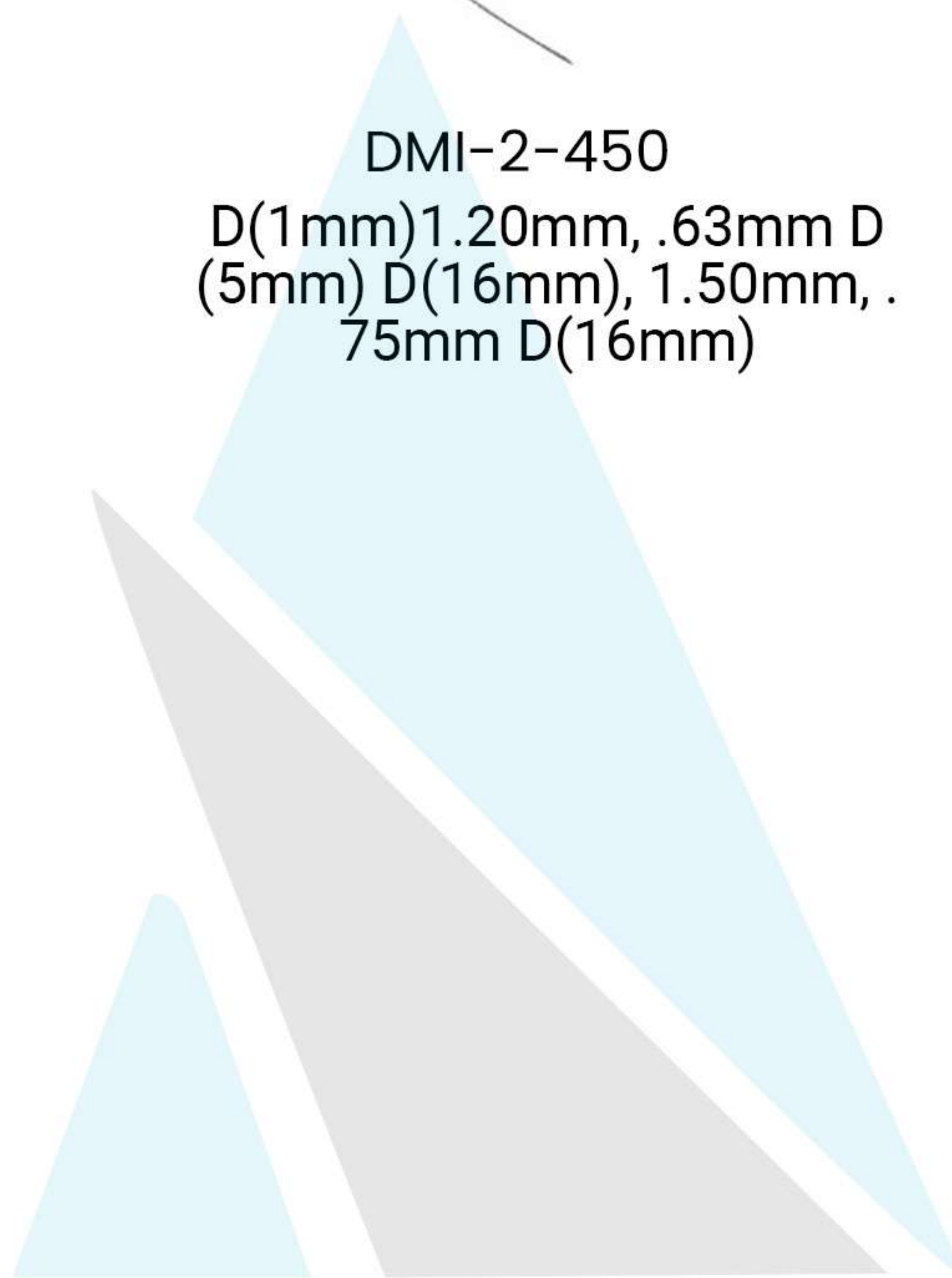

DMI-2-452
D1 .55mm, D16 .85mm



DMI-2-453
D1 .85mm, D16 1.15mm



DMI-2-454
D1 1.00mm, D16 1.30mm

**Endodontic Condensers,
Obturation Instruments Excavators, Probes**



DMI-2-455
D1 .25mm/D1 .35mm



DMI-2-456
D1 .35mm/D1 .55mm



DMI-2-457
D1 .55mm/D1 .70mm

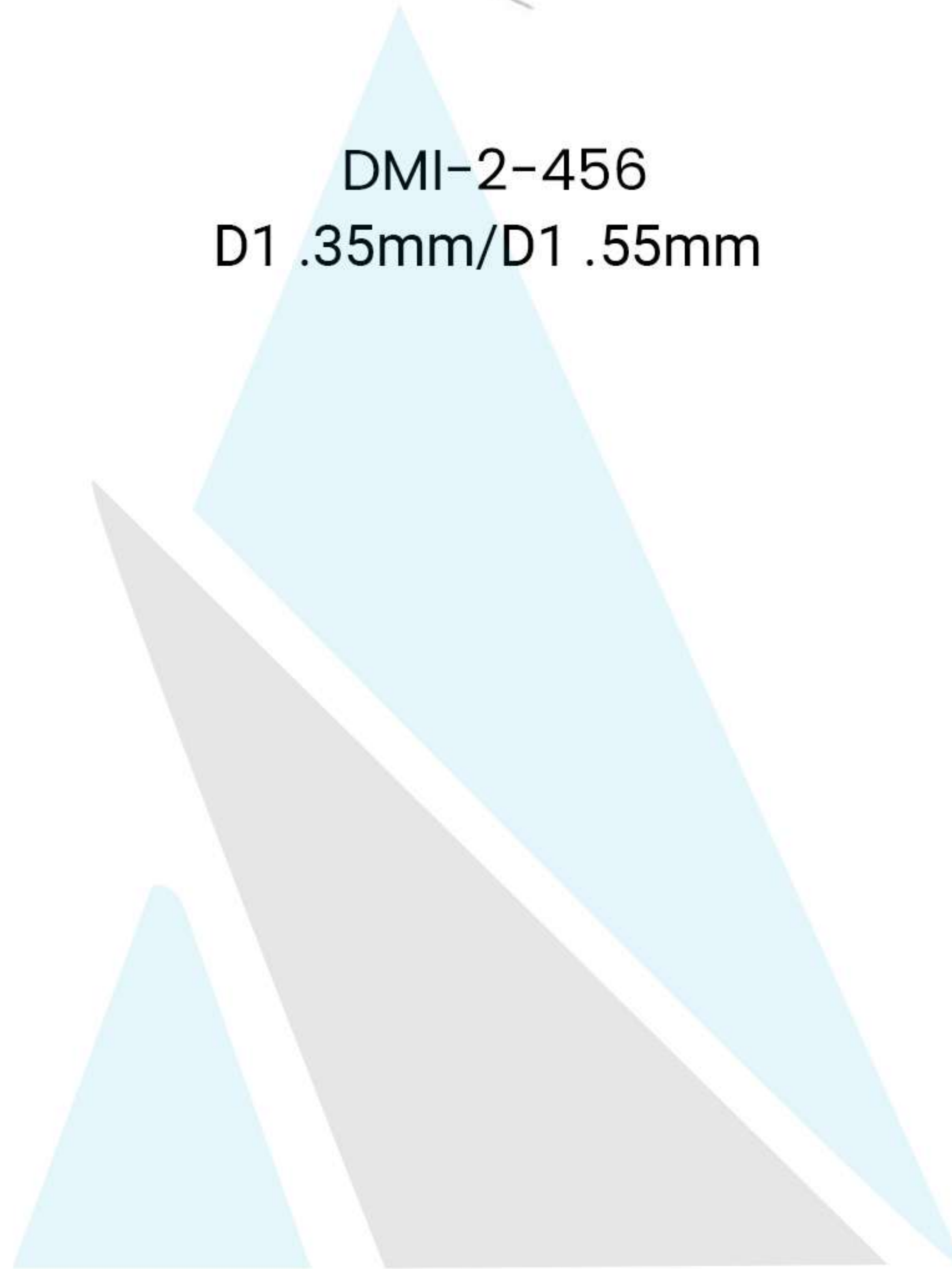

DMI-2-458
No. 14



DMI-2-459
No. 17



DMI-2-460
No. 18

**Amalgam Pluggers Condensers,
Burnishers**



DMI-2-501
BEHRMAN (Fig. 1)



DMI-2-502
BLACK (Fig. 1-2)



DMI-2-503
MORQUETTE (Fig. 0/1)

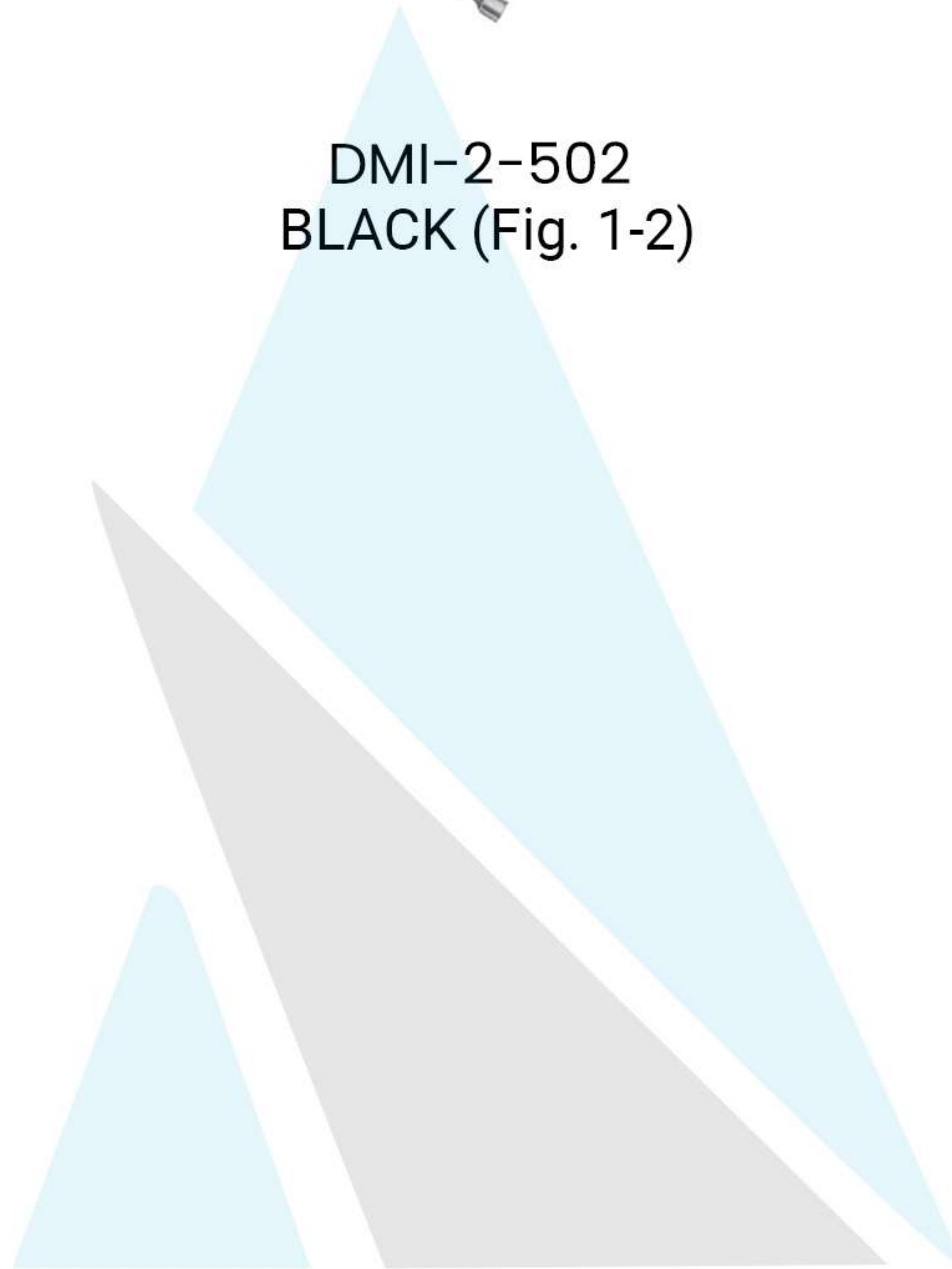

DMI-2-504
Black Action 11/12 Plugger



DMI-2-505
Hollenback No.1 Plugger



DMI-2-506
Hollenback No. 2 Plugger



**Amalgam Pluggers Condensers,
Burnishers**



DMI-2-507
Blacks 0-1 (1mm-1.5mm)



DMI-2-508
Blacks 1-2 (1.5mm-2.5mm)



DMI-2-509
Amalgam Pluggers Condensers,
Burnishers

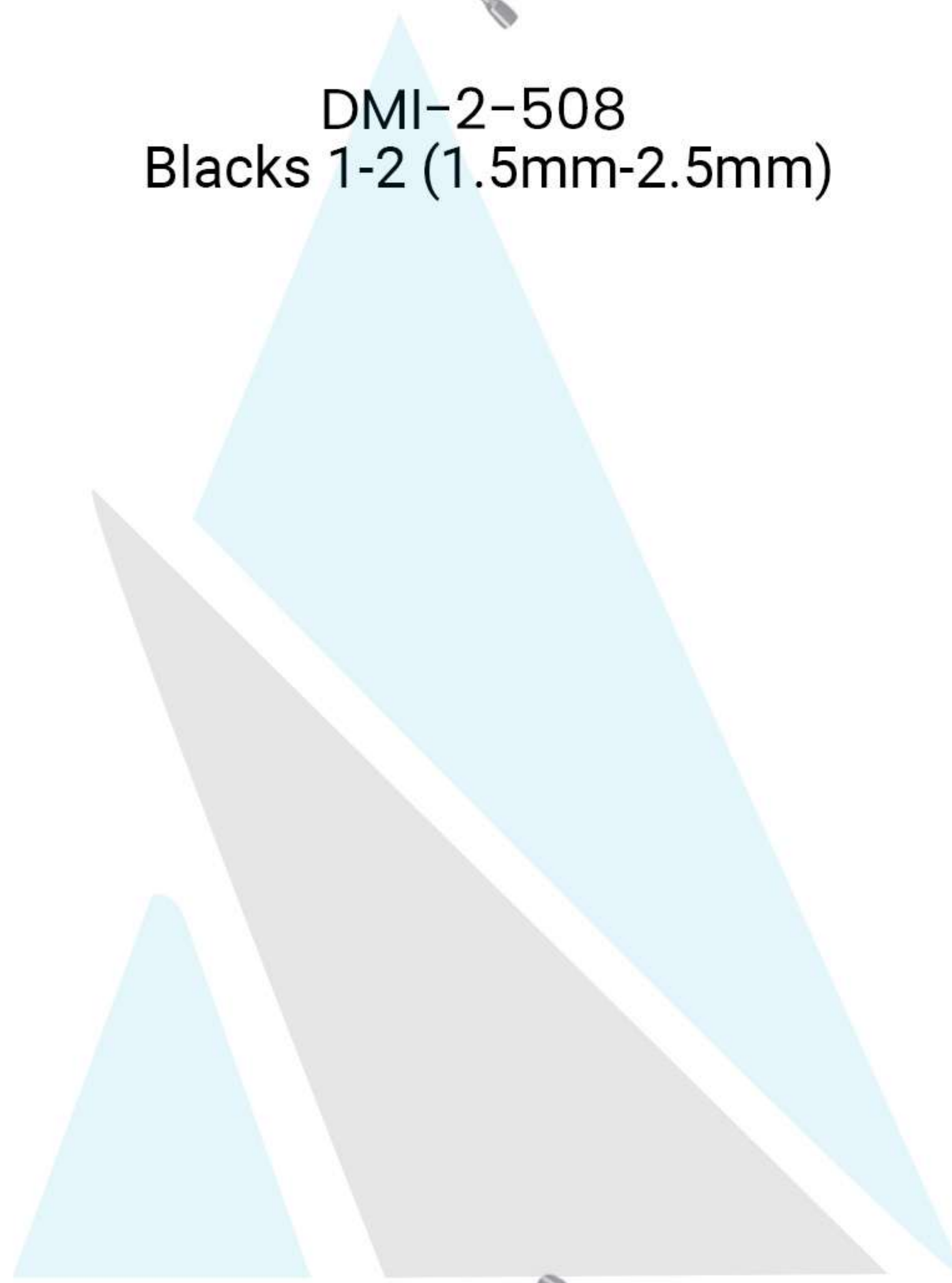

DMI-2-510
Bodkin 1 (.7mm-1mm)



DMI-2-511
Bodkin 2 (1.5mm-2mm)



DMI-2-512
2.5mm-3mm



Amalgam Pluggers Condensers, Burnishers



DMI-2-513
Oregon 2



DMI-2-514
.7mm-1mm



DMI-2-515
1mm-1.5mm

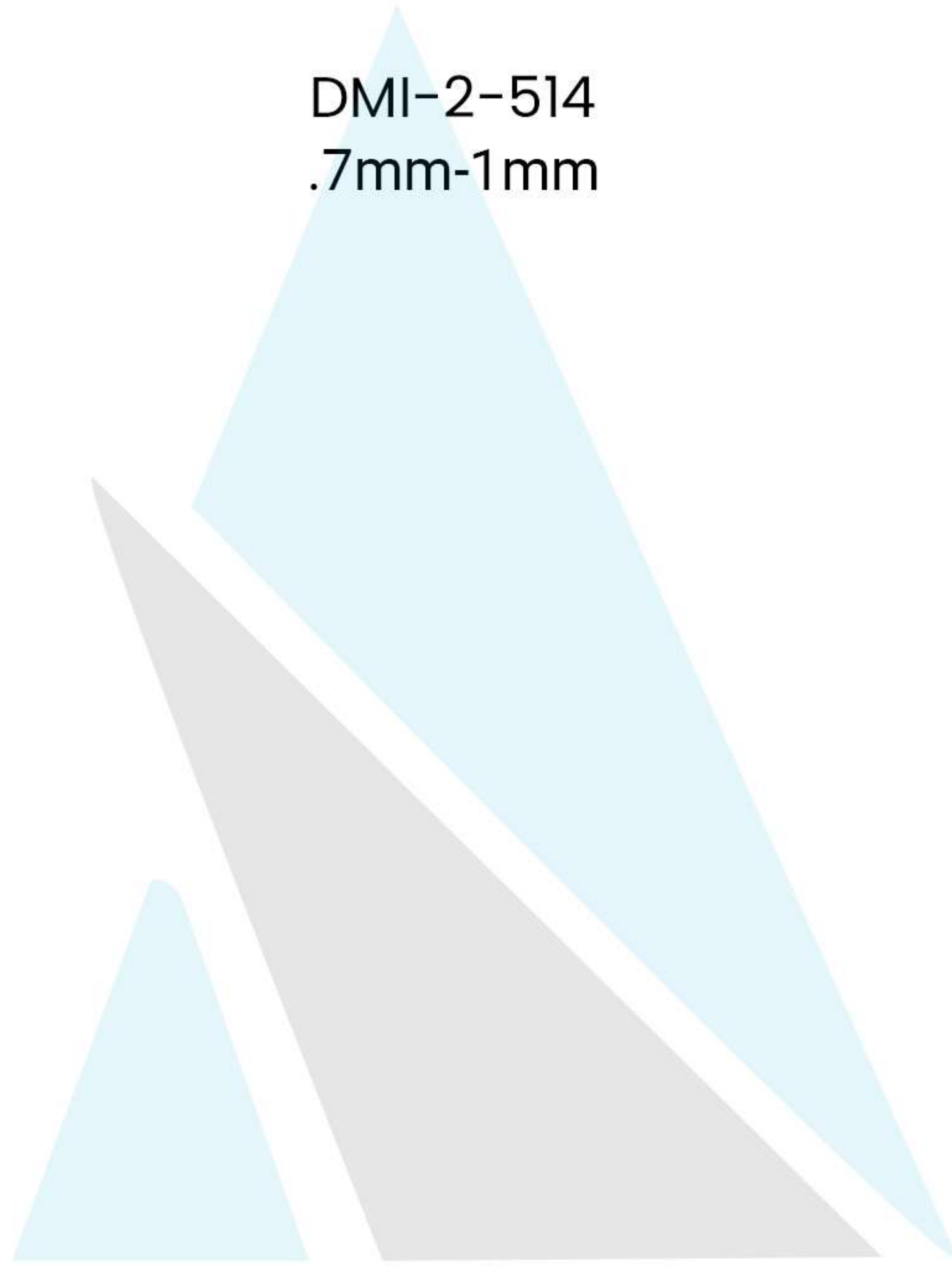

DMI-2-516
1.5mm-2mm



DMI-2-517
Oregon (Fig. 3)



DMI-2-518
Oregon (Fig. 4)



**Amalgam Pluggers Condensers,
Burnishers**

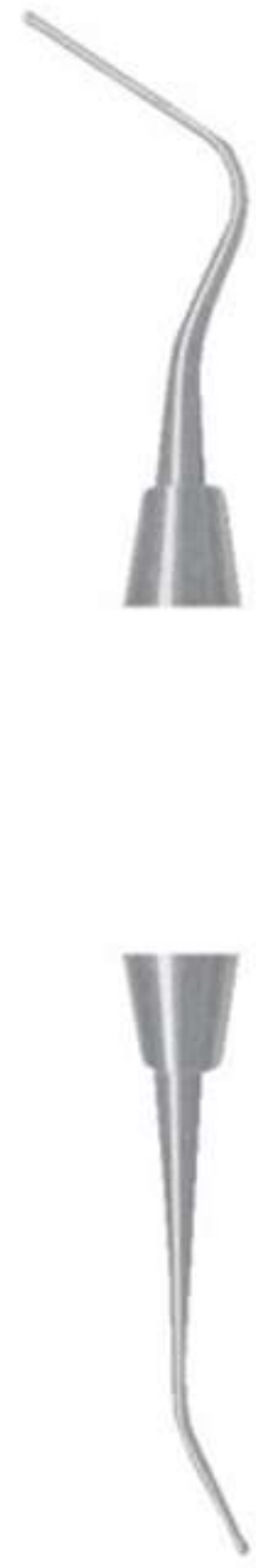

DMI-2-519
UP 12



DMI-2-520
Applicator 1-2



DMI-2-521
Birtles Applicator Spatula K

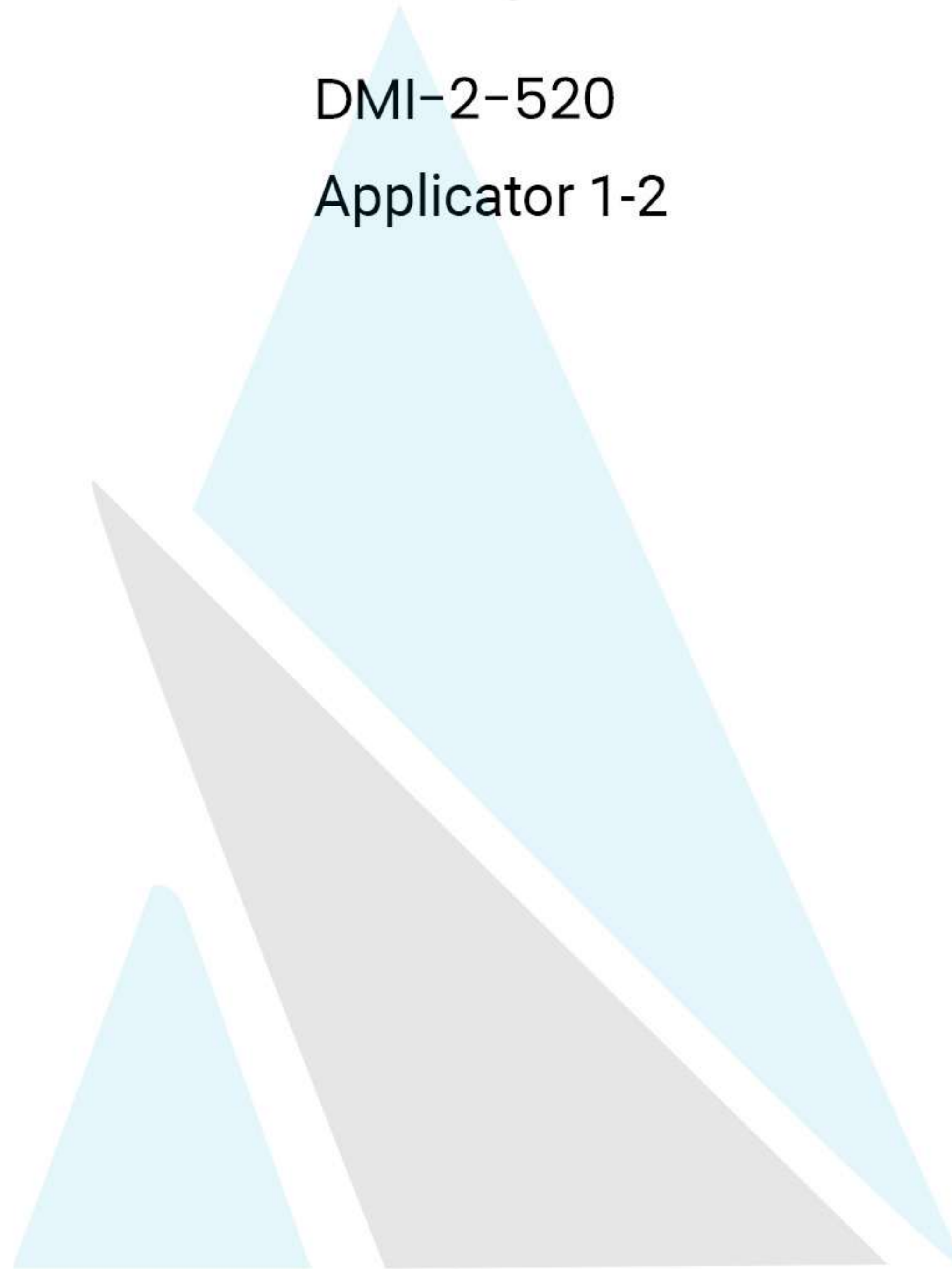

DMI-2-522
Fig. 1



DMI-2-523
Fig. 28/29



DMI-2-524
Fig. 34

**Amalgam Pluggers Condensers,
Burnishers**



ART-DSC-2-525
Fig. 27/29



ART-DSC-2-526
Fig. 21B



ART-DSC-2-527
ACORN Fig. 21

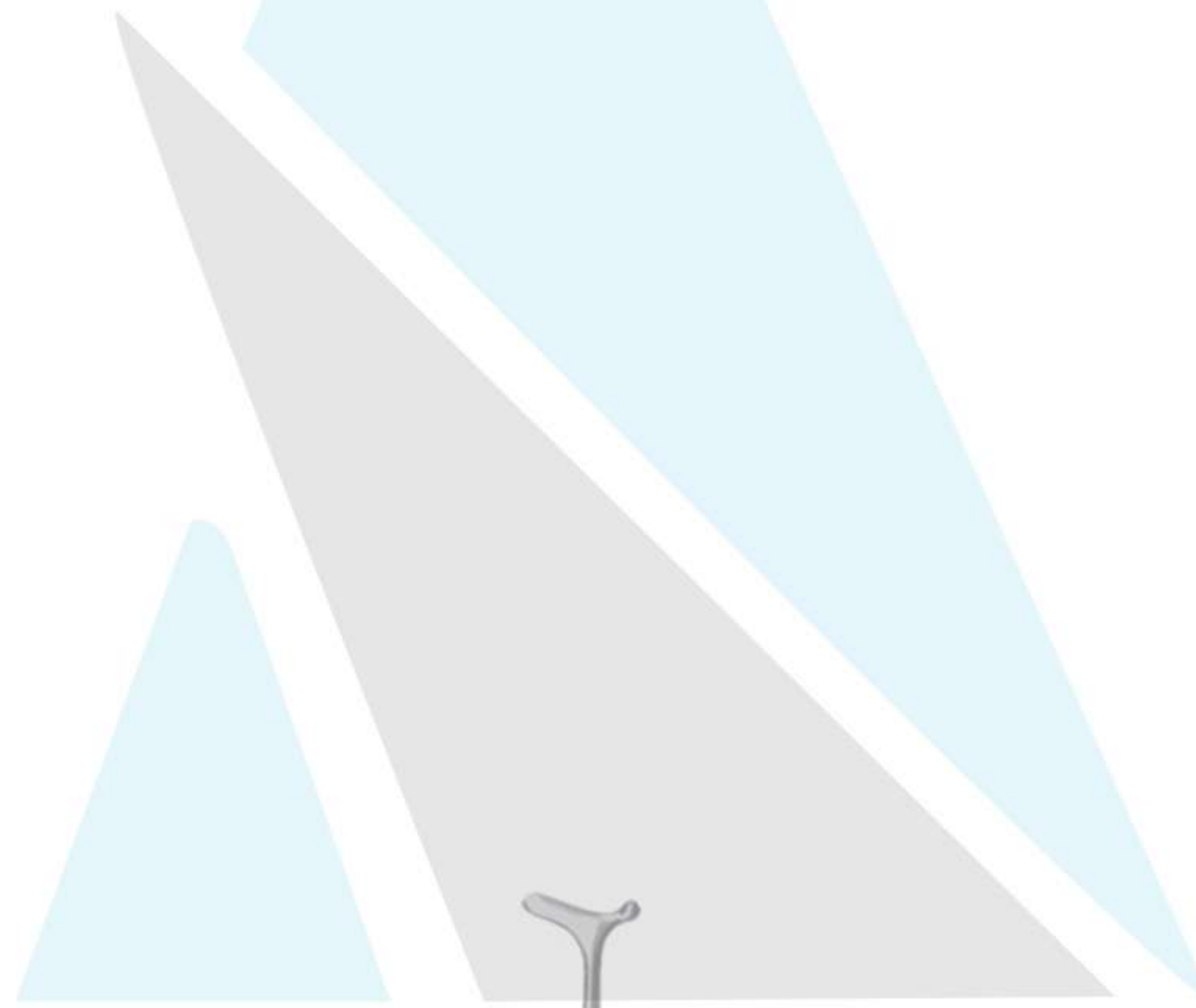

ART-DSC-2-528
Fig. 21B



ART-DSC-2-529
Fig. 2-34



ART-DSC-2-530
Amalgam Pluggers Condensers,
Burnishers v



**Amalgam Pluggers Condensers,
Burnishers**



DMI-2-531
Fig. 26-28



DMI-2-532
Fig. 2-30



DMI-2-533
Fig. 26-30

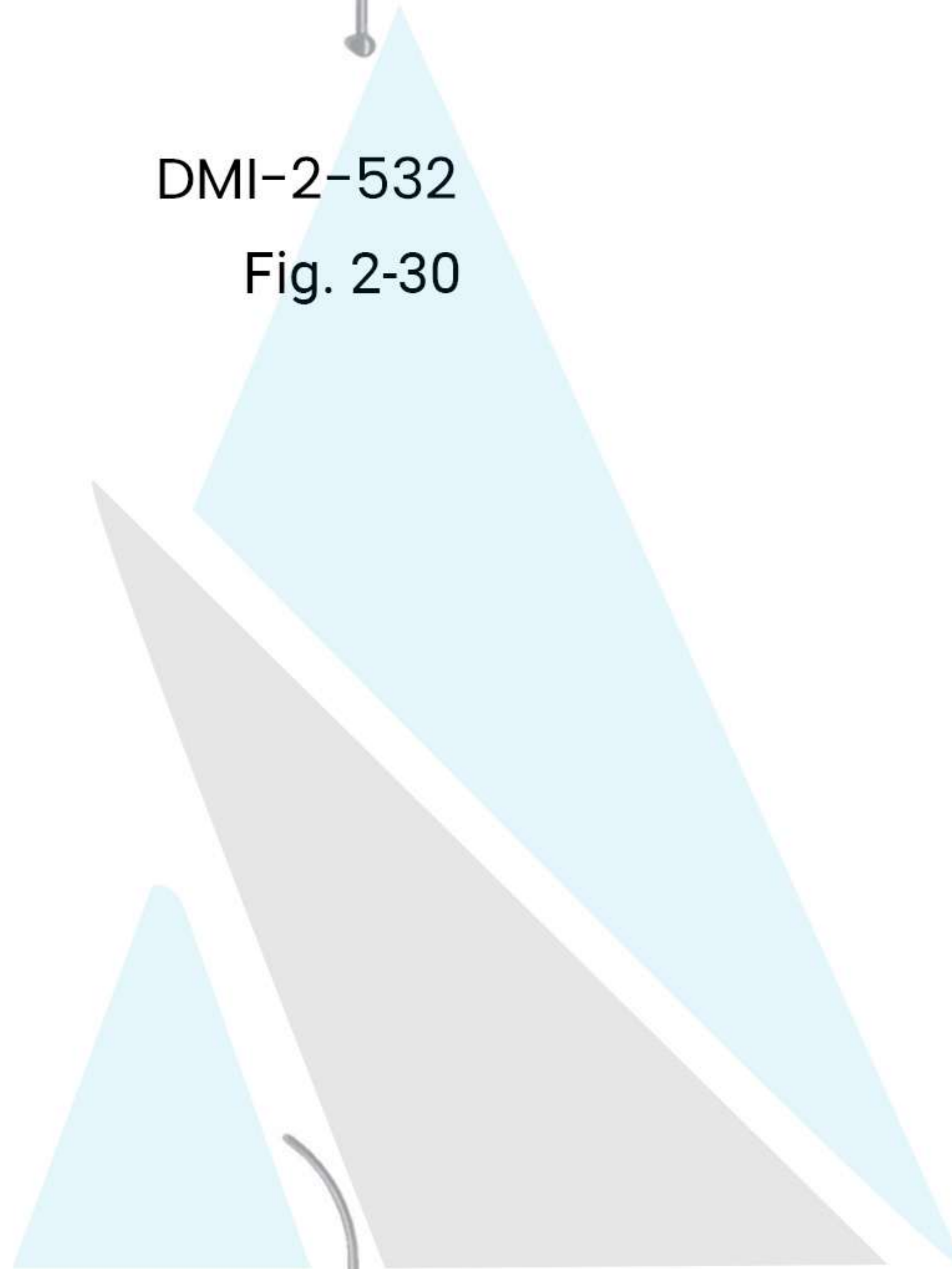

DMI-2-534
Fig. 27-29



DMI-2-535
PKT 1



DMI-2-536
Fig. 27-30

**Amalgam Pluggers Condensers,
Burnishers**



DMI-2-543
Pitts Pedo 19



DMI-2-544
PKT 4



DMI-2-545
Pitts Pedo 18



DMI-2-546
PKT 5

Wax Carvers, Carvers, Chisels

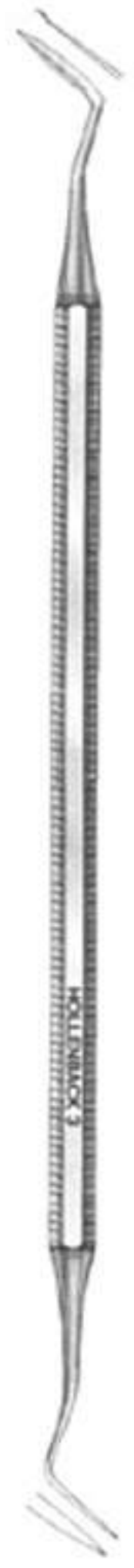

DMI-2-601
HOLLENBACK Fig. 3



DMI-2-602
HOLLENBACK Fig. 3S



DMI-2-603
WARD Fig. 1



DMI-2-604
WARD Fig. 2



DMI-2-605
WALL Fig. 1



DMI-2-606
WALL Fig. 3



DMI-2-607
Fig. 3/6 Cleoid/Discoid



DMI-2-608
Fig. 89/92 Cleoid/Discoid



DMI-2-609
1.5mm Cleoid Discoid
(Shown with GTX Finish)



DMI-2-610
2mm Cleoid Discoid



DMI-2-611
3mm Cleoid Discoid



DMI-2-612
FRAHM Fig. 2-3 (off-angle)

Wax Carvers, Carvers, Chisels



DMI-2-613
Interproximal 1



DMI-2-614
Interproximal 1



DMI-2-615
Baum Interproximal



DMI-2-616
Sho A Carver



DMI-2-617
Thompson 2



DMI-2-618
GOLLOBIN Fig. 1

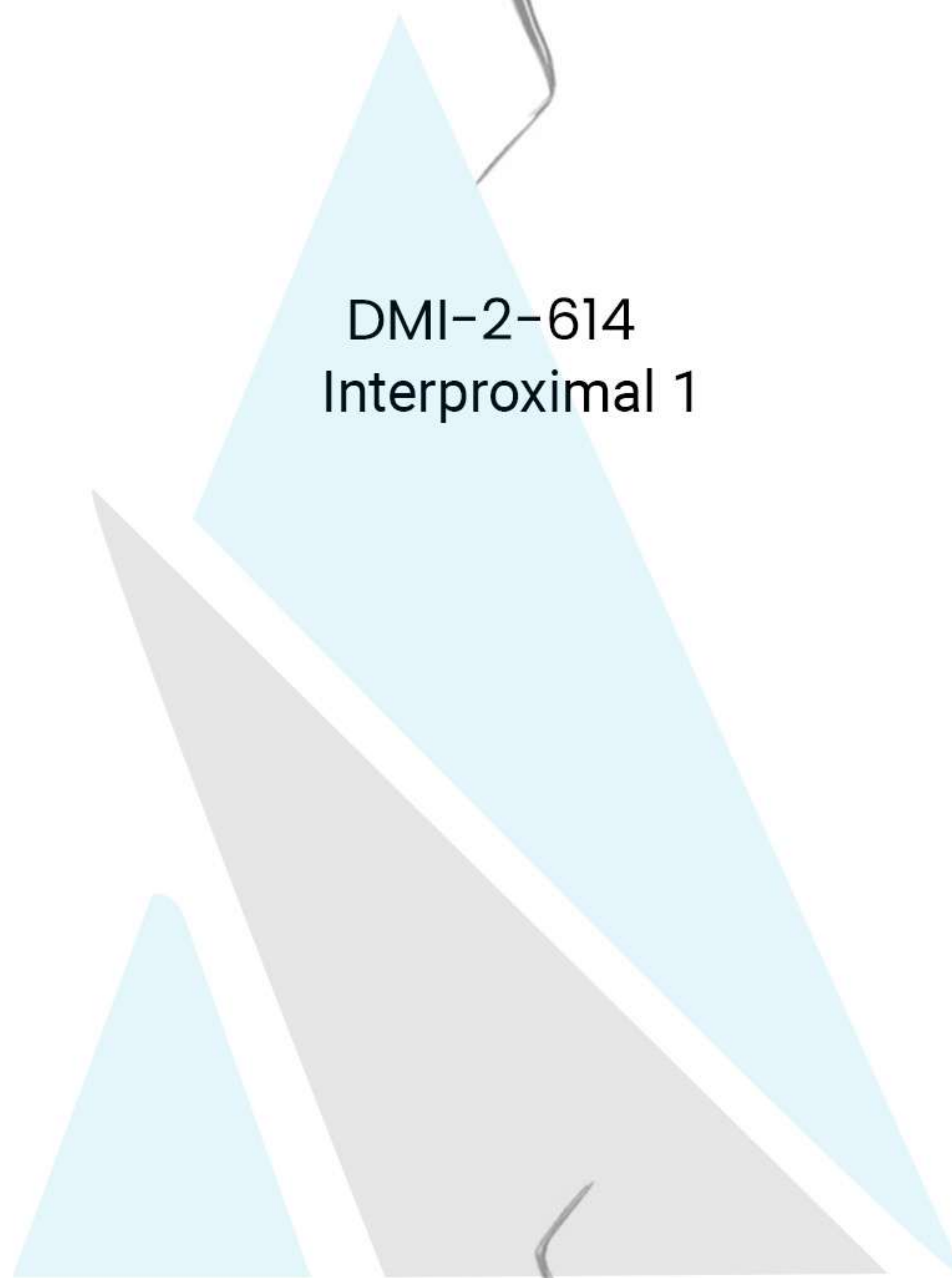

Wax Carvers, Carvers, Chisels



DMI-2-619
Wax Carvers, Carvers,
ChiselsHOLLENBACK Fig. 1/2

DMI-2-620
HOLLENBACK Fig. 3

DMI-2-621
THOMPSON (Fig. 3)
(½ Hollenback Hoe & Wall 3)

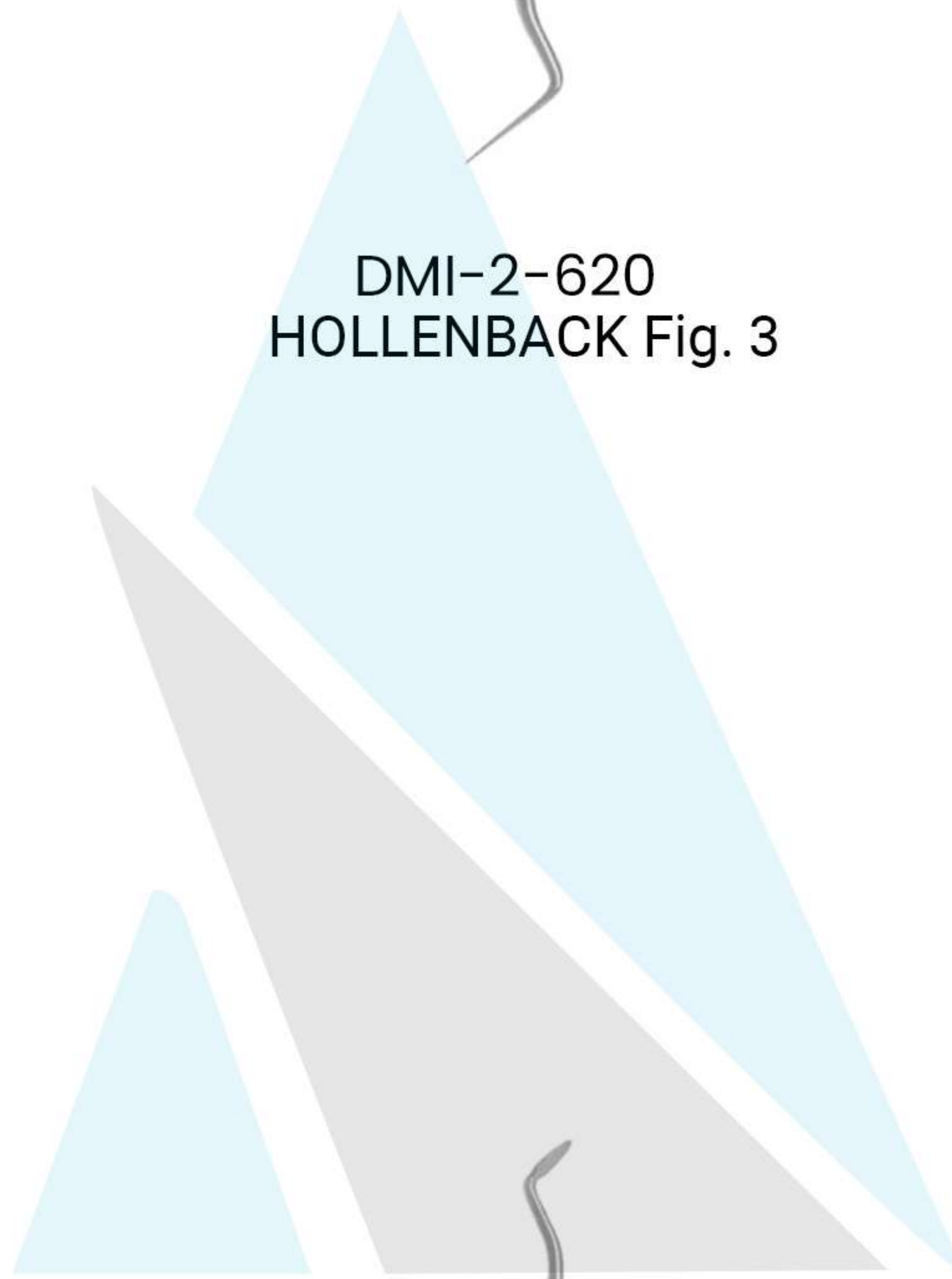

DMI-2-622
THOMPSON (Fig. 5)
(½ Hollenback Hoe & Tanner 5)

DMI-2-623
THOMPSON (Fig. 8)
(3mm Cleoid & Wall 3)

DMI-2-624
THOMPSON (Fig. 9)
(Hollenback 3 & Wall 3)



DMI-2-625
WARD Fig. 2



DMI-2-626
Composite Interproximal



DMI-2-627
TANNER Fig. 5



DMI-2-628
TANNER Fig. 6



DMI-2-629
THARP Fig. 1



DMI-2-630
THOMPSON Fig. 1



Wax Carvers, Carvers, Chisels



DMI-2-631
University of Minnesota Fig. 1

DMI-2-632
University of Minnesota Fig. 2

DMI-2-633
COTTLE RHINOPLASTIC
INSTRUMENTS ETC



DMI-2-634
UPR Fig. 1

DMI-2-635
Contour Carbide (Fig. 1-2)

DMI-2-636
Cleoid Discoid

Wax Carvers, Carvers, Chisels



DMI-2-637
Contour Carbide (Fig. 10-11)

DMI-2-638
1.5mm Bin-Angle (15-8-8)

DMI-2-639
1.5mm Straight (15)



DMI-2-640
1mm Wedelstaedt (10-15-3)

DMI-2-641
1.5mm Wedelstaedt (15-15-3)

DMI-2-642
2mm Wedelstaedt (20-15-3)

**Curettes, Gracey Curettes,
Dental Products**



DMI-2-701
RULE 3-4



DMI-2-702
GRACEY GC 1-2



DMI-2-703
GRACEY GC 3-4



DMI-2-704
GRACEY GC 5-6



DMI-2-705
GRACEY GC 7-8



DMI-2-706
GRACEY GC 9-10

**Curettes, Gracey Curettes,
Dental Products**



DMI-2-707
GRACEY GC 11-12



DMI-2-708
G1-2



DMI-2-709
G3-4

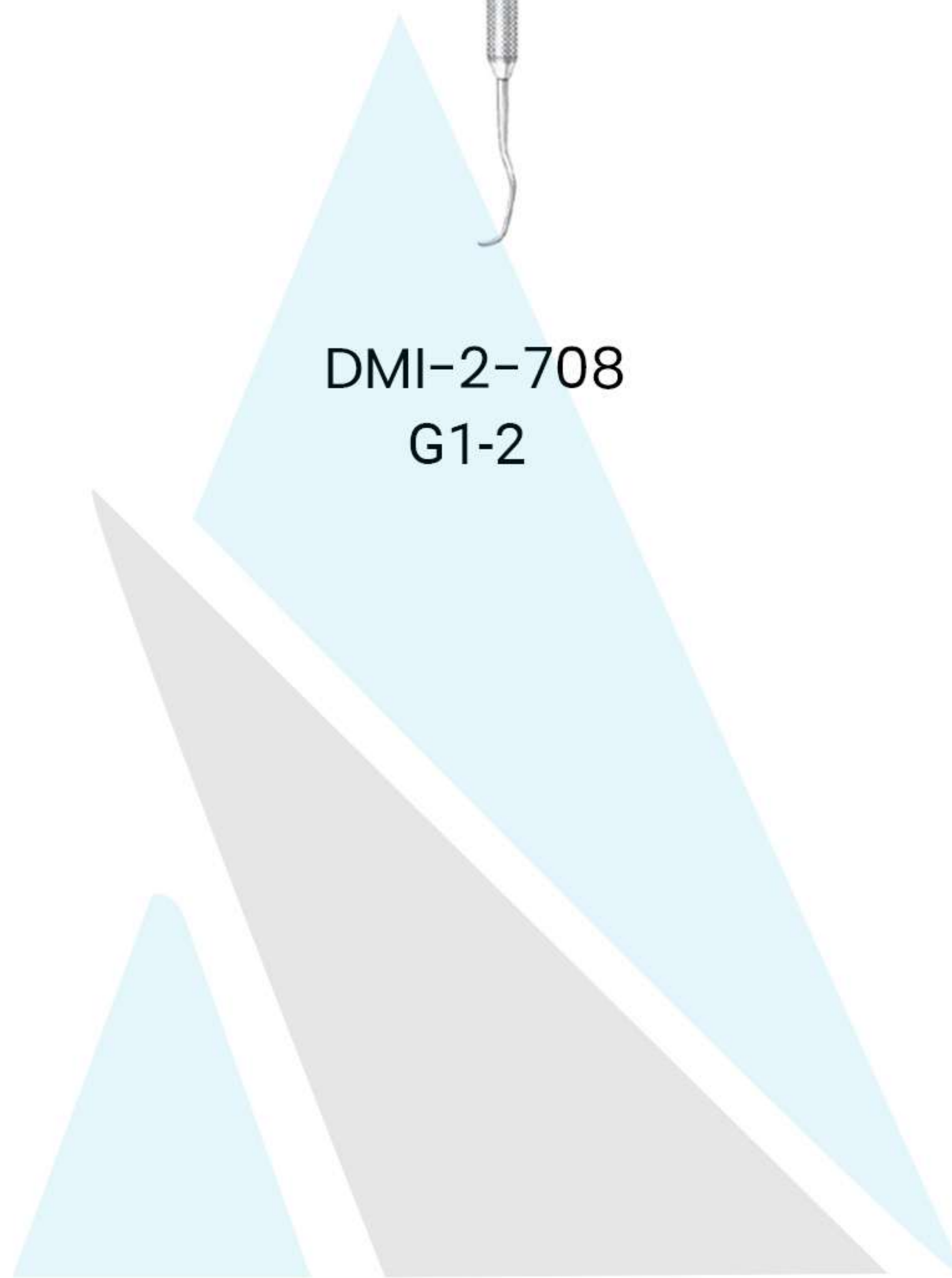

DMI-2-710
G5-6



DMI-2-711
G7-8



DMI-2-712
G9-10

**Curettes, Gracey Curettes,
Dental Products**



DMI-2-713
G11-12



DMI-2-714
G13-14



DMI-2-715
COLUMBIA 4R-4L



DMI-2-716
COLUMBIA 13-14



DMI-2-717
MCCALLS 17-18



DMI-2-718
BARNHART 1-2

**Curettes, Gracey Curettes,
Dental Products**



DMI-2-719
BARNHART 5-6



DMI-2-720
LANGER 1-2



DMI-2-721
LANGER 3-4

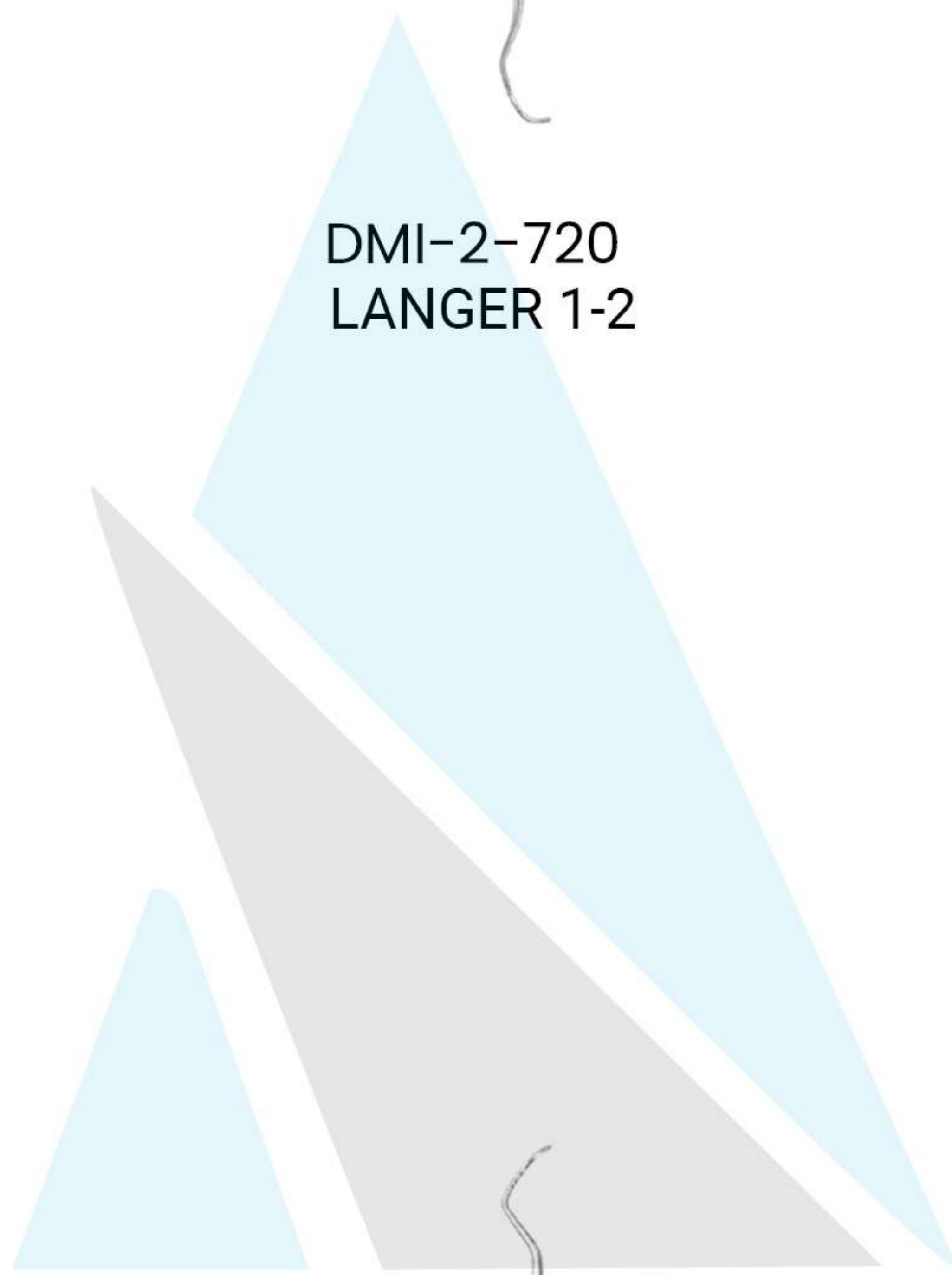

DMI-2-722
LANGER 5-6



DMI-2-723
4L-4R



DMI-2-724
13-14

**Curettes, Gracey Curettes,
Dental Products**



DMI-2-725
2L-2R



DMI-2-726
13-14



DMI-2-727
17-18



DMI-2-728
17S-18S



DMI-2-729
Universal Scaler



DMI-2-730
GF2 Curette

**Curettes, Gracey Curettes,
Dental Products**



DMI-2-731
GF3 Curette



DMI-2-732
GF4 Curette



DMI-2-733
GF6 Hoe



DMI-2-734
GF7 Knife



DMI-2-735
GF8 Spear Knife



DMI-2-736
GF9 Knife Scaler

**Curettes, Gracey Curettes,
Dental Products**



DMI-2-737
GF 11 Spear Knife



DMI-2-738
GF 21 Sharp Spoon / Small Scaler



DMI-2-739
MCCALL (17S-18S)



DMI-2-740
Root Plane (1-2)



DMI-2-741
Root Plane (5-6)



DMI-2-742
Root Plane (7-8)



**Curettes, Gracey Curettes,
Dental Products**



DMI-2-743
Root Plane (11-12)



DMI-2-744
Root Plane (13-14)



DMI-2-745
Petite (1-2)



DMI-2-746
Petite (11-12)



DMI-2-747
Root Plane (5-6)



DMI-2-748
Root Plane (7-8)

**Curettes, Gracey Curettes,
Dental Products**



DMI-2-749
BARNHART (5-6)



DMI-2-750
GRACEY (1-2)



DMI-2-751
GRACEY (3-4)



DMI-2-752
GRACEY (5-6)



DMI-2-753
GRACEY (7-8)



DMI-2-754
GRACEY (9-10)

**Curettes, Gracey Curettes,
Dental Products**



DMI-2-755
GRACEY (11-12)



DMI-2-756
GRACEY (13-14)



DMI-2-757
GRACEY (2L-2R)



DMI-2-758
COLUMBIA (4L-4R)



DMI-2-759
COLUMBIA (13-14)



DMI-2-760
LANGER (1-2)



DMI-2-761
LANGER (3-4)



**Wax Porcelain And Cement
Instruments Wax & Modeling Instruments**



DMI-2-801
ROACH-A



DMI-2-802
ROACH-B



DMI-2-803
LECRON 5-B

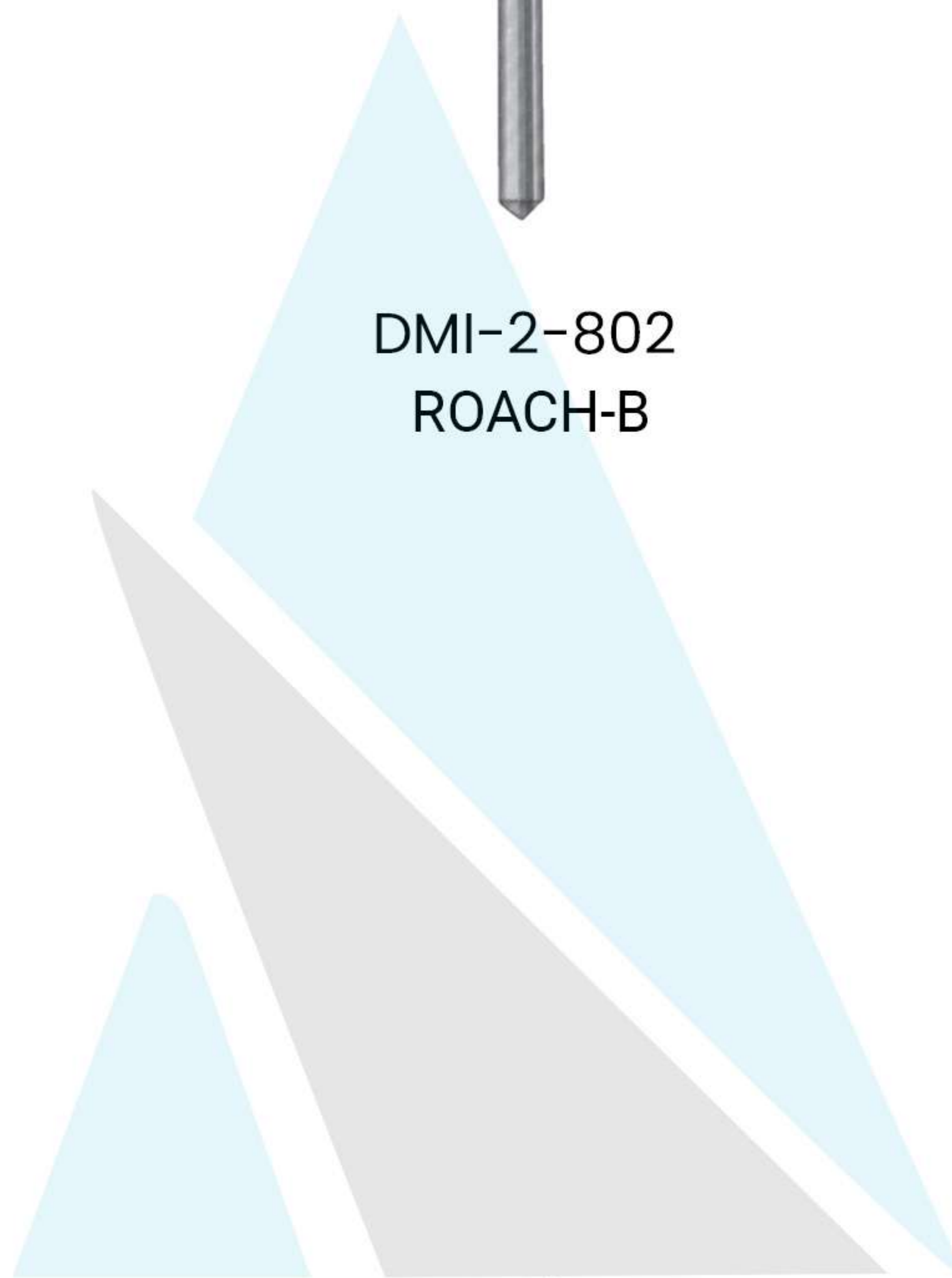

DMI-2-804
VEHE-A



DMI-2-805
VEHE-B



DMI-2-806
A7

**Wax Porcelain And Cement
Instruments Wax & Modeling Instruments**



DMI-2-807
B7



DMI-2-808
WARD 2-A



DMI-2-809
WARD 2-B

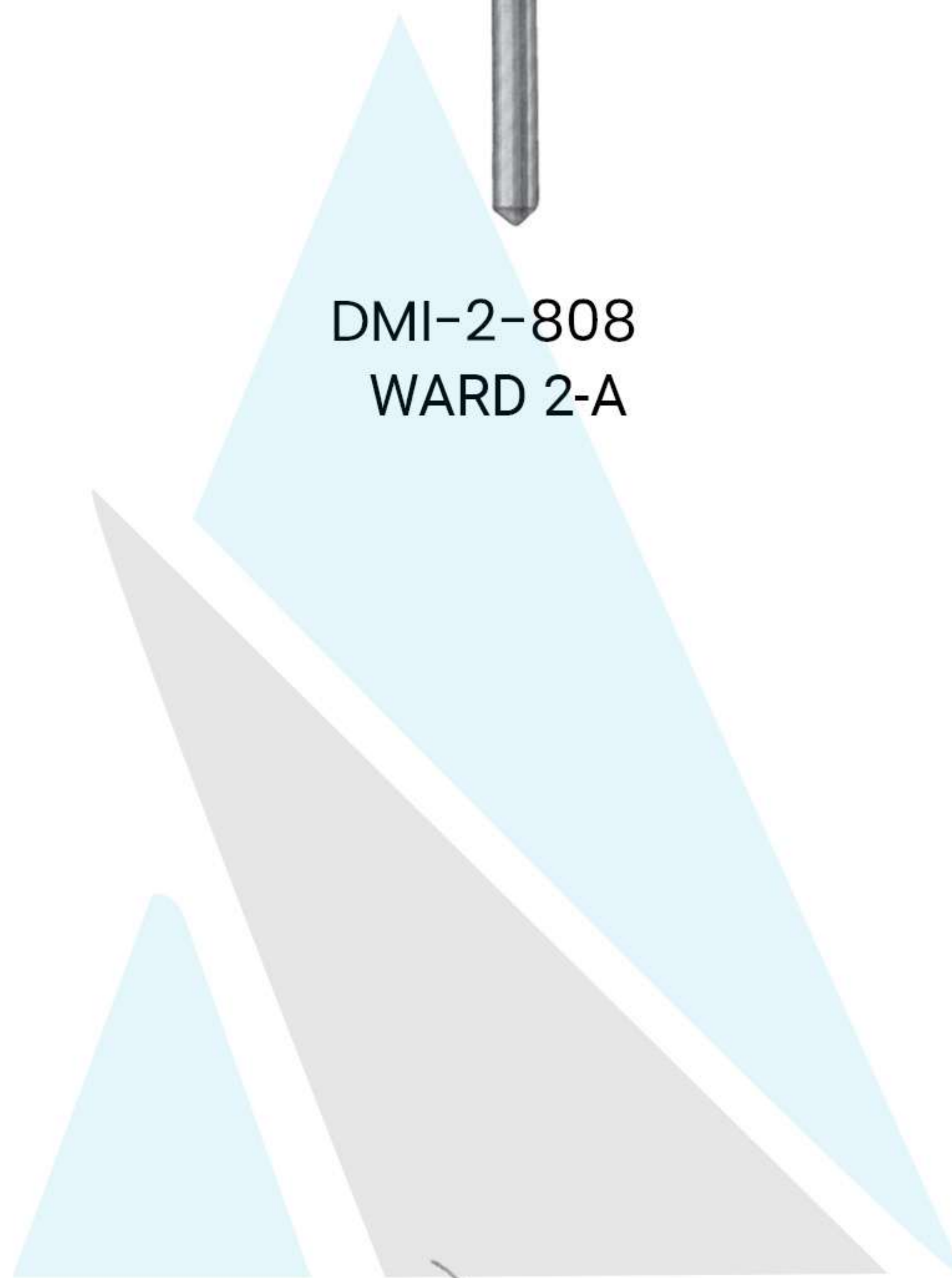

DMI-2-810
PKT 1



DMI-2-811
PKT 2



DMI-2-812
PKT 3

**Wax Porcelain And Cement
Instruments Wax & Modeling Instruments**



DMI-2-813
PKT 4



DMI-2-814
PKT 5



DMI-2-815
Hollenback 3

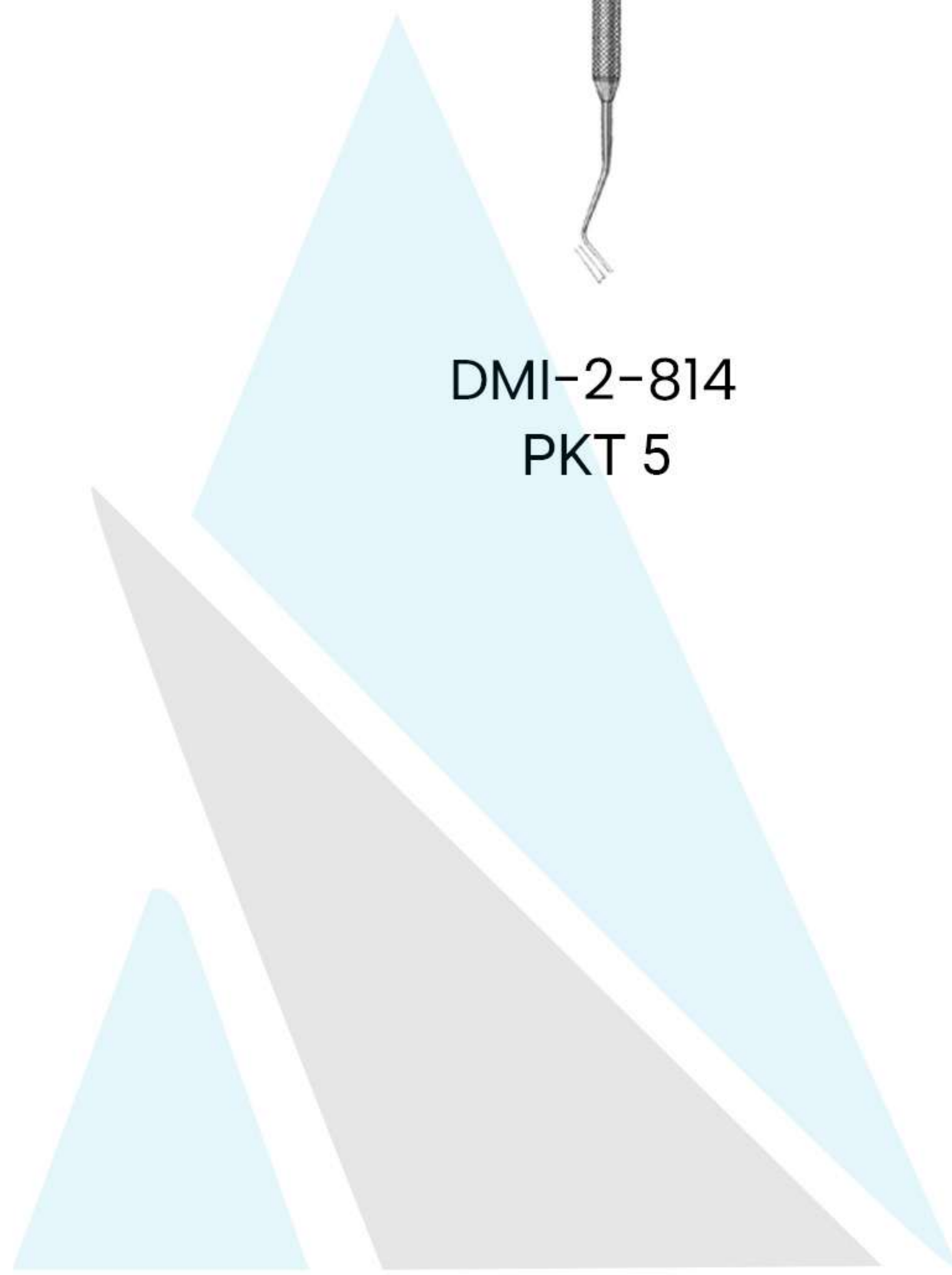

DMI-2-816
Hollenback 3S



DMI-2-817
WARD 1



DMI-2-818
WARD 2

**Wax Porcelain And Cement
Instruments Wax & Modeling Instruments**



DMI-2-819
WALL 1



DMI-2-820
WALL 3



DMI-2-821
Le Cron

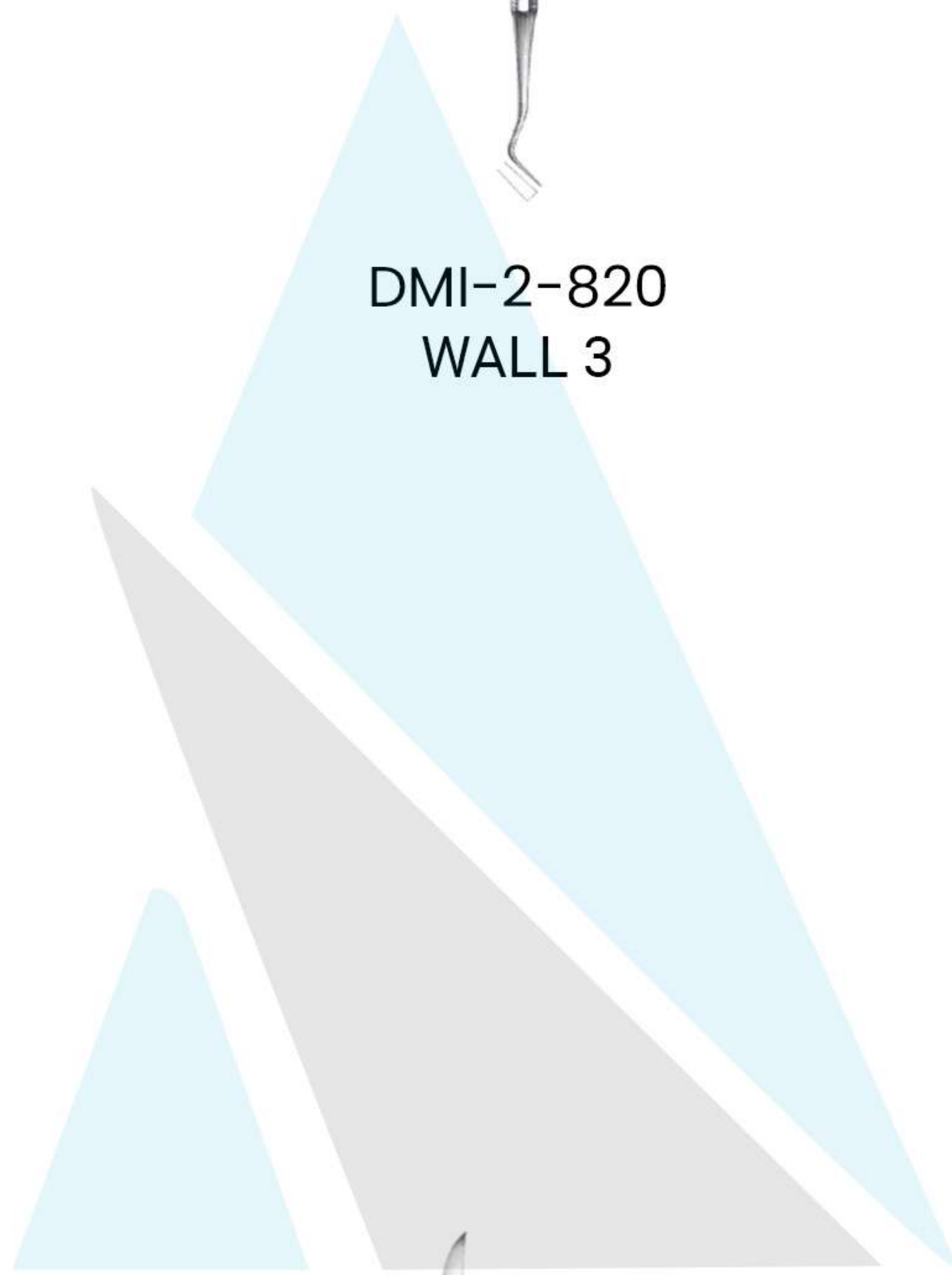

DMI-2-822
Le Cron



DMI-2-823
Le Cron



DMI-2-824
MSY

**Wax Porcelain And Cement
Instruments Wax & Modeling Instruments**



DMI-2-825
MSY



DMI-2-826
Le Cron



DMI-2-827
Hylin



DMI-2-828
Hylin



DMI-2-829
Hylin



DMI-2-830
Zahle

**Wax Porcelain And Cement
Instruments Wax & Modeling Instruments**



DMI-2-831
Zahle



DMI-2-832
Zahle



DMI-2-833



DMI-2-834
Beale



DMI-2-835
Roach



DMI-2-836
Vehe

**Wax Porcelain And Cement
Instruments Wax & Modeling Instruments**



DMI-2-837
Fig.0



DMI-2-838
Fig.1



DMI-2-839
Fig.2

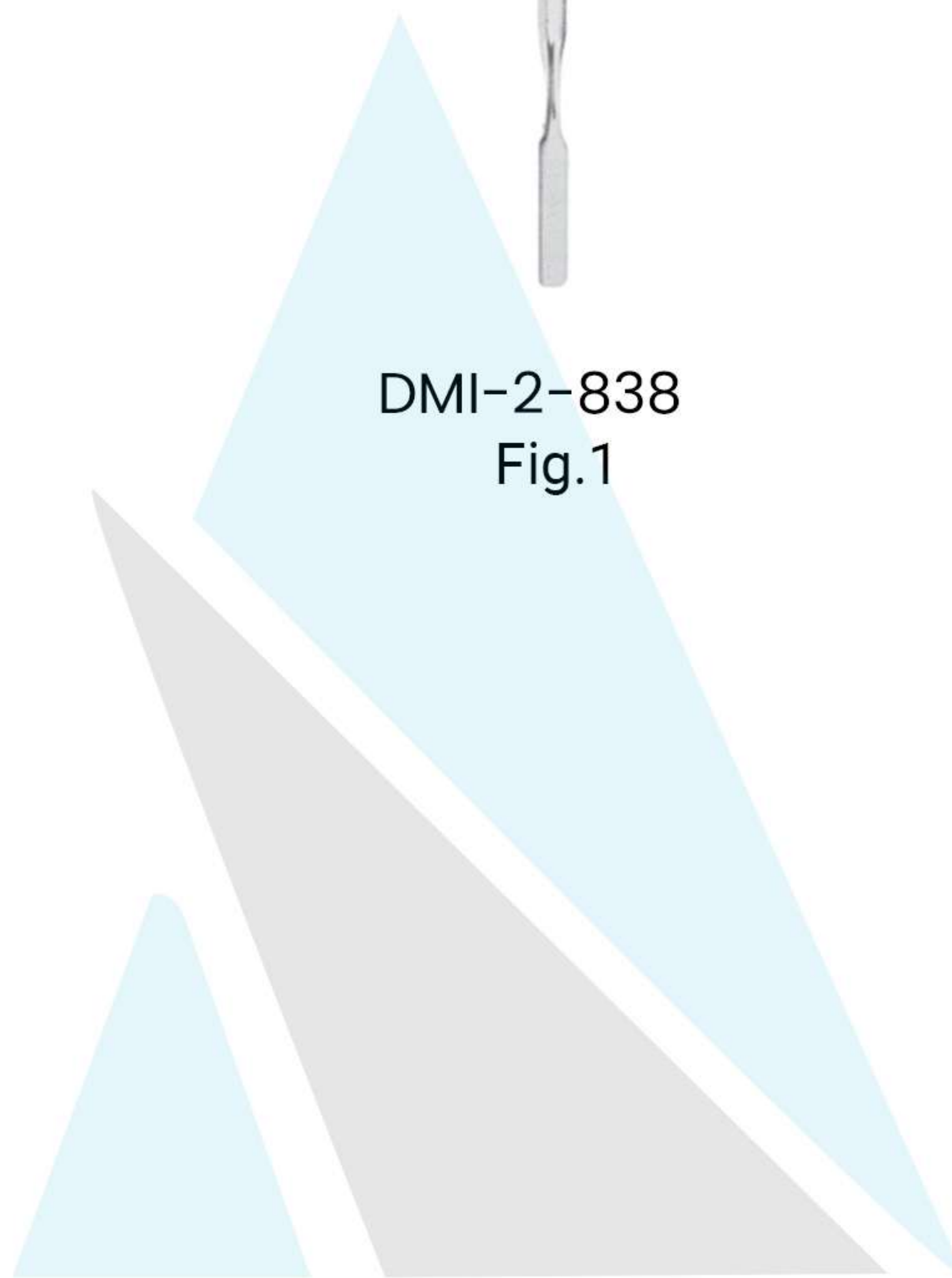

DMI-2-840
Fig.3



DMI-2-841
Fig.4



DMI-2-842
Weston Fig.3

**Wax Porcelain And Cement
Instruments Wax & Modeling Instruments**



DMI-2-843
Fig.1



DMI-2-844
Fig.1



DMI-2-845
LECRON Inlay

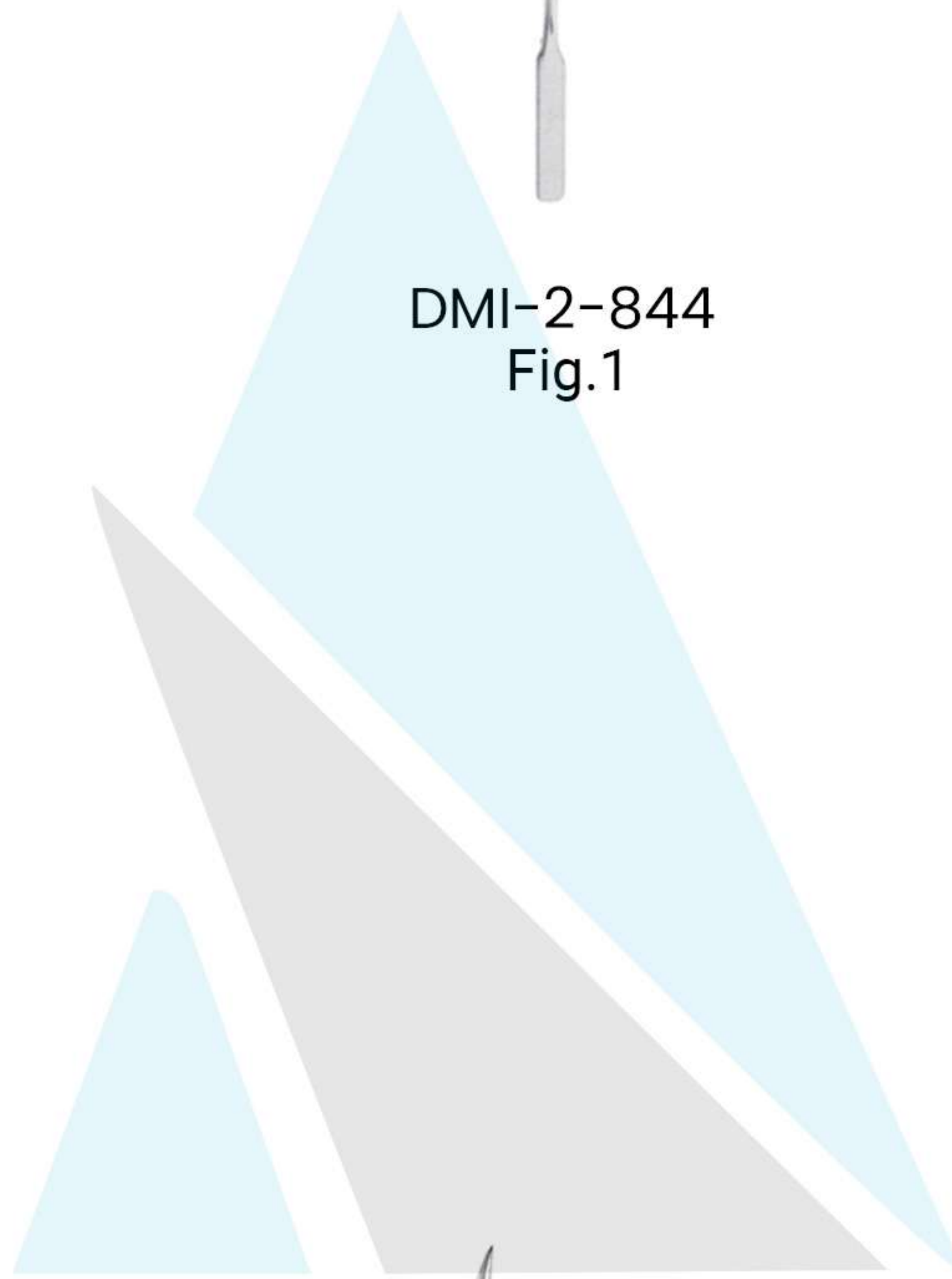

DMI-2-846
REEVES



DMI-2-847
VEHE Wax



DMI-2-848
ROACH Wax

**Wax Porcelain And Cement
Instruments Wax & Modeling Instruments**



DMI-2-849
W-31



DMI-2-850
W-5



DMI-2-851
W-7



DMI-2-852
W-7A



DMI-2-853
W-7G



DMI-2-854
AGATHE

**Wax Porcelain And Cement
Instruments Wax & Modeling Instruments**



DMI-2-855
C-7



DMI-2-856
C-5



DMI-2-857
C-313

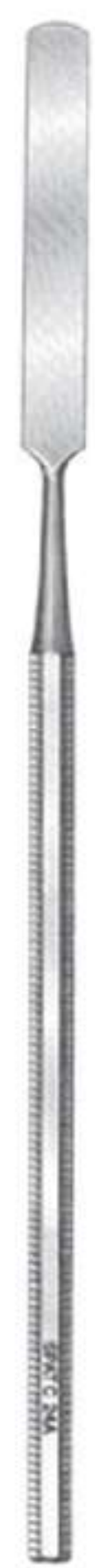

DMI-2-858
C-24A Rigid



DMI-2-859
C-24 Flexible



DMI-2-860
C-24 Flexible

**Wax Porcelain And Cement
Instruments Wax & Modeling Instruments**



DMI-2-861
C-7



DMI-2-862
C-5



DMI-2-863
C-313



DMI-2-864
C-24A Rigid

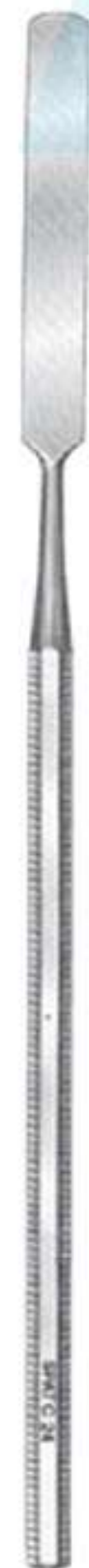

DMI-2-865
C-24 Flexible



DMI-2-866
C-24 Flexible



DMI-2-867

Spatulas, Cement Spatulas



DMI-2-901
C-7



DMI-2-902
24



DMI-2-903
A6



DMI-2-904
26



DMI-2-905
7 Wax



DMI-2-906
All Metal Spatulas with
High Polish Stainless Steel Blade

Spatulas, Cement Spatulas



DMI-2-907
31



DMI-2-908
Fig. 1 18.5 cm



DMI-2-909
Fig. 2 18 cm

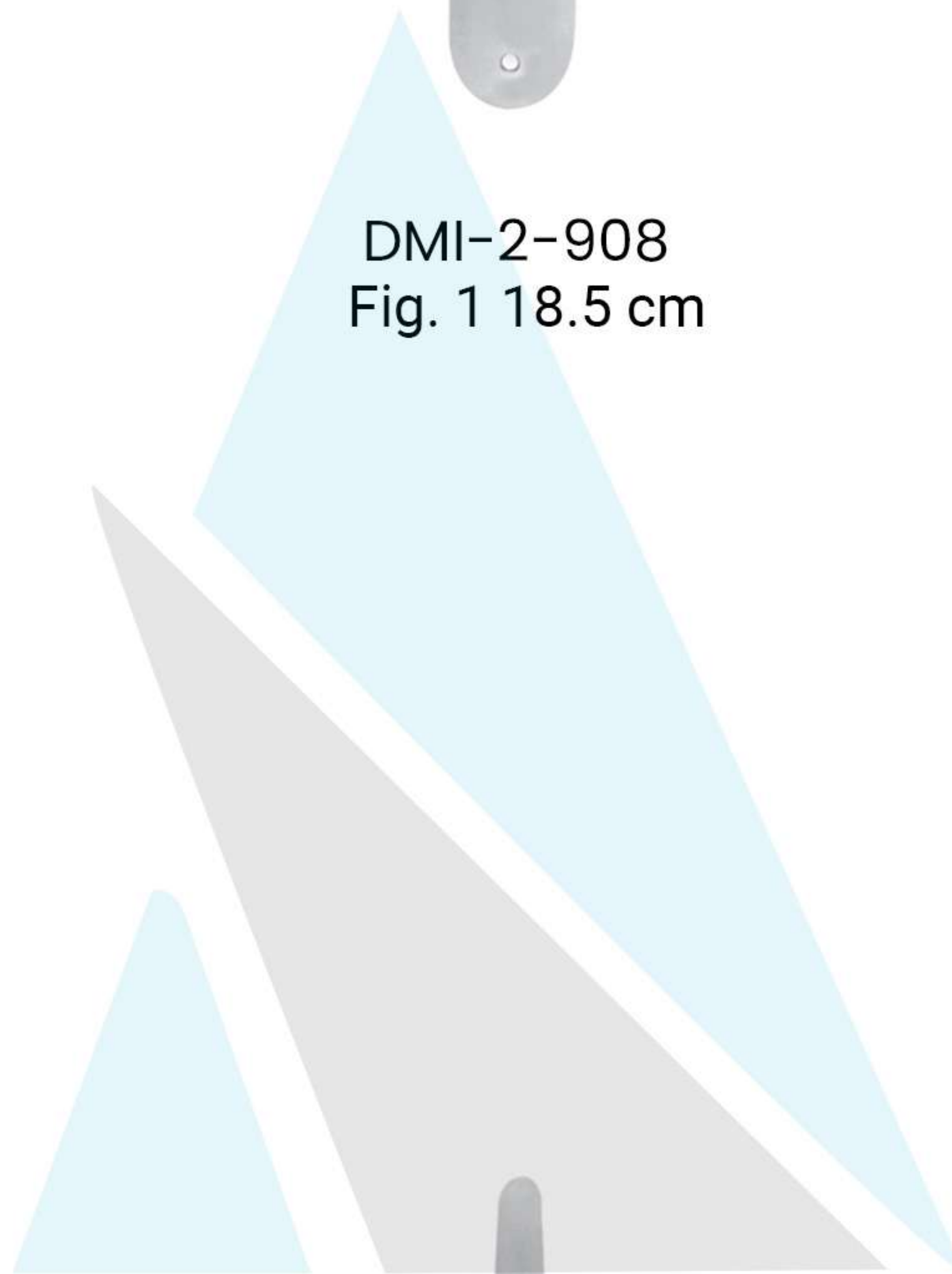

DMI-2-910
Fig. 3 18.5 cm
26



DMI-2-911
Fig. 4 19.5 cm



DMI-2-912
Fig. 5 21.5 cm

Spatulas, Cement Spatulas



DMI-2-913
Fig. 6 20.5 cm



DMI-2-914
Fig. 7 19.5 cm



DMI-2-915
Fig. 8 20 cm



DMI-2-916
Fig. 9 22.5 cm



DMI-2-1001
Hirshfeld 3-7

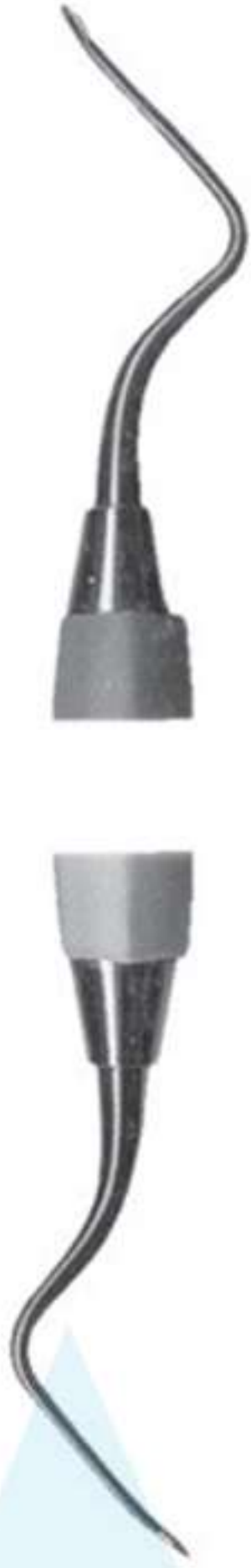

DMI-2-1002
Hirshfeld 5-11



DMI-2-1003
Hirshfeld 9-10



DMI-2-1004
Orban 10-11



DMI-2-1005
2079



DMI-2-1006
Orban 8-9



DMI-2-1007
UWH 16-18



DMI-2-1008
UWH 18-19



DMI-2-1009
UWH 20-21



DMI-2-1010
2084



DMI-2-1011
Urban Knife (1-2)



DMI-2-1012
1 SE



DMI-2-1013
2-3



DMI-2-1014
Kirkland 13-13L



DMI-2-1015
Knife Orban 1-2 TT DEO



DMI-2-1016
Fahnenstock Fig, 1 12,5cm



DMI-2-1017
Fahnenstock Fig, 2 17cm



DMI-2-1018
Lessmann Fig, 1 12,5cm

Files, Hoes, Knives, Wax & Plaster Knives



DMI-2-1019
Lessmann Fig, 2 17cm



DMI-2-1020
Files, Hoes, Knives, Wax & Plaster
Knife Con scodellino Fig, 1 12,5cm



DMI-2-1021
Con scodellino Fig, 2 17cm



DMI-2-1022
Ermert



DMI-2-1023
Ermert



DMI-2-1024
Files, Hoes, Knives, Wax &
Plaster Knives



DMI-2-1025
18 cm 7 1/8"



DMI-2-1026
17 cm 6 3/4" Gritman



DMI-2-1027
17 cm 6 3/4" Gritman



DMI-2-1028
17 cm 6 3/4" Medicon



DMI-2-1029
Fig, 1 17 cm



DMI-2-1030
22 cm 8 3/4"



DMI-2-1031
22 cm 8 3/4"



DMI-2-1032
Gritman Fig, 2 17 cm



DMI-2-1033
Fig, 3 16 cm



DMI-2-1034
Fig, 4 16 cm



DMI-2-1035
Ck1 Pocket Marker



DMI-2-1036
Ck2 Pocket Marker

Files, Hoes, Knives, Wax & Plaster Knives



DMI-2-1037
Knife



DMI-2-1038
Dissector



DMI-2-1039
Scaler



DMI-2-1040

**Bone Curettes, Bone Files, Bone
Chisels, Bone Mallets**

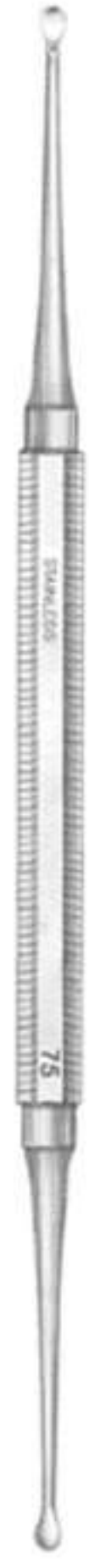

DMI-2-1101
No. 75

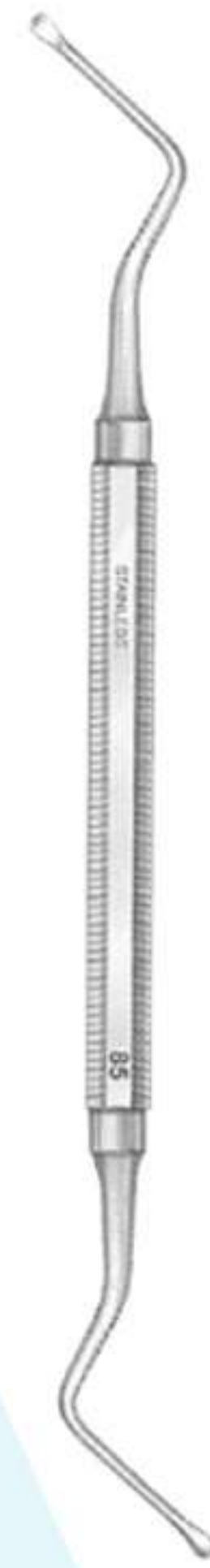

DMI-2-1102
No. 85

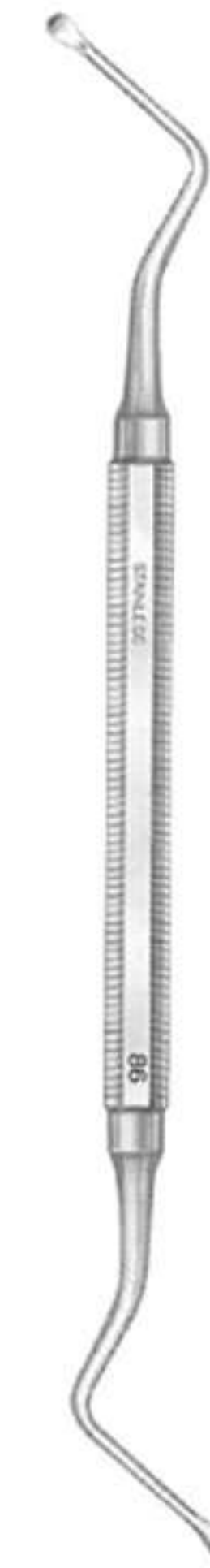

DMI-2-1103
No. 86

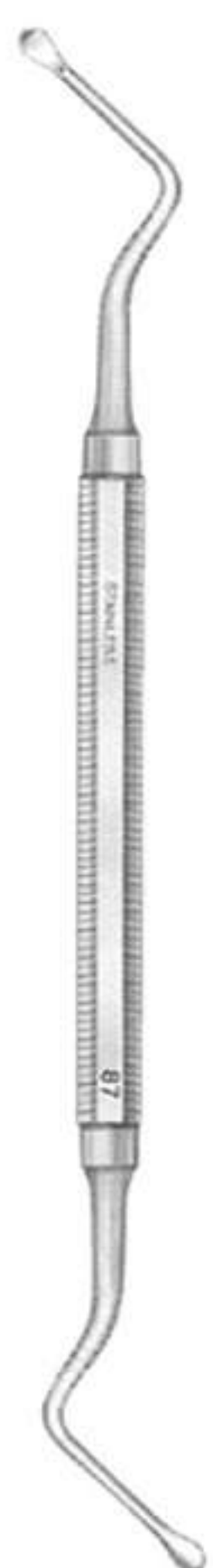

DMI-2-1104
No. 87



DMI-2-1105
No. 2/4



DMI-2-1106
No. 1

Bone Currettes, Bone Files, Bone Chisels, Bone Mallets



DMI-2-1107
No. 2



DMI-2-1108
No. 4



DMI-2-1109
No. 5L



DMI-2-1111
No.6R

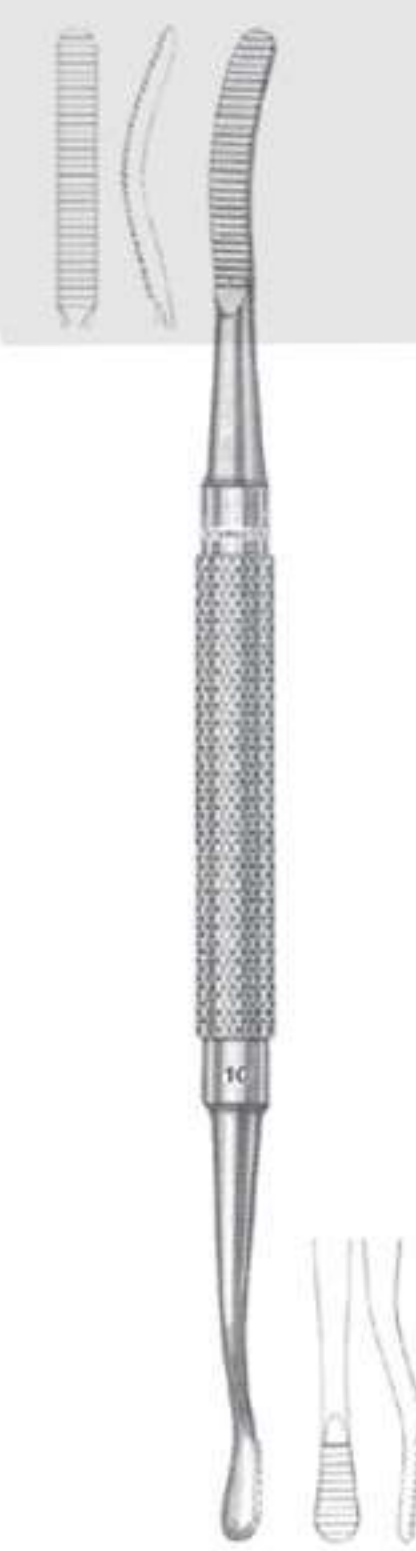
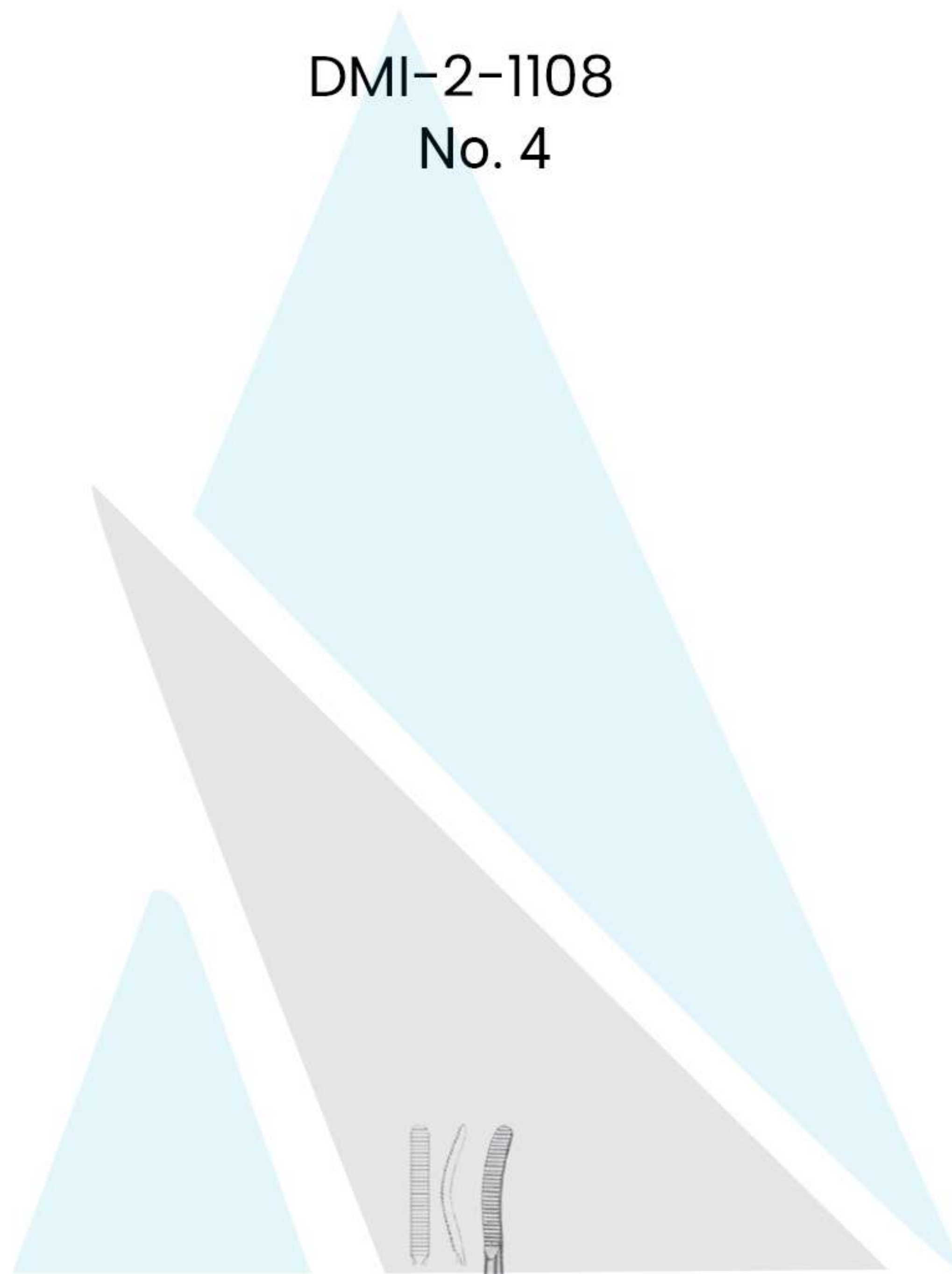

DMI-2-1112
No. 10

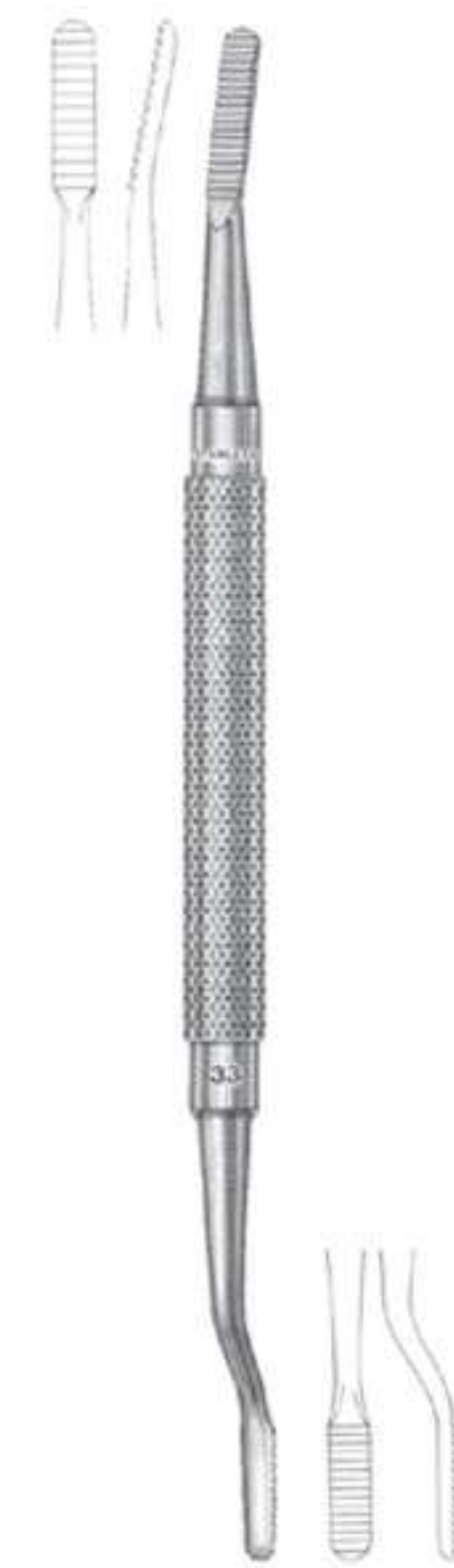

DMI-2-1113
No. 33

**Bone Currettes, Bone Files, Bone
Chisels, Bone Mallets**



DMI-2-1113
MILLER No. 33



DMI-2-1114
MILLER No. 64



DMI-2-1115
HOWARD No. 12

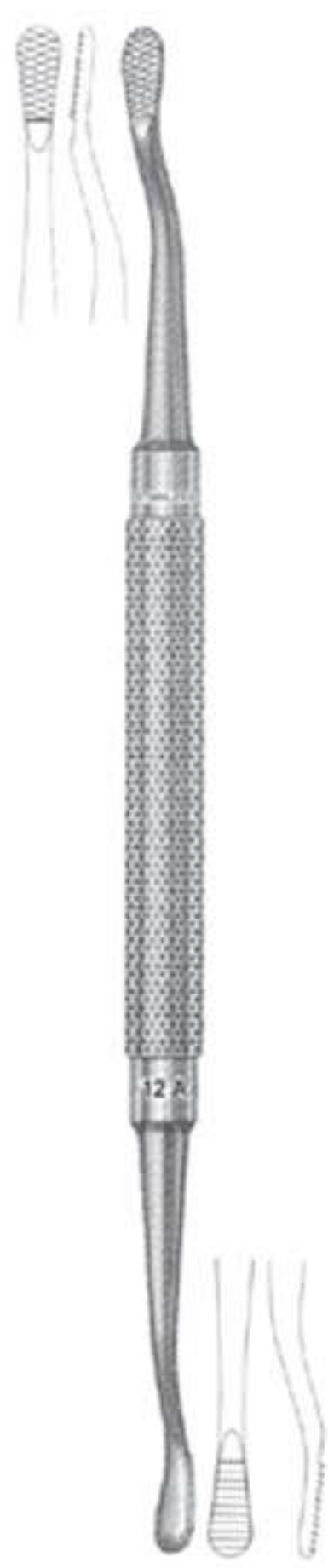

DMI-2-1116
HOWARD No. 12A



DMI-2-1117
HOWARD No. 12CA

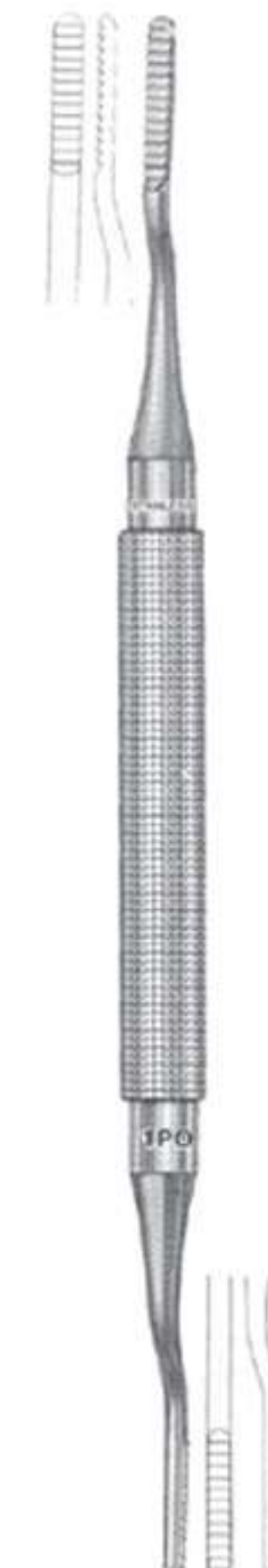

DMI-2-1118
POLOKOFF No. 1

**Bone Currettes, Bone Files, Bone
Chisels, Bone Mallets**



DMI-2-1119
GARDNER No. 1



DMI-2-1120
GARDNER No. 2



DMI-2-1121
GARDNER No. 5



DMI-2-1122
GARDNER No. 5R



DMI-2-1123
WAKEFIELD No. 1W



DMI-2-1124
WAKEFIELD No. 2W

**Bone Currettes, Bone Files, Bone
Chisels, Bone Mallets**



DMI-2-1125
3 mm



DMI-2-1126
4 mm



DMI-2-1127
5 mm

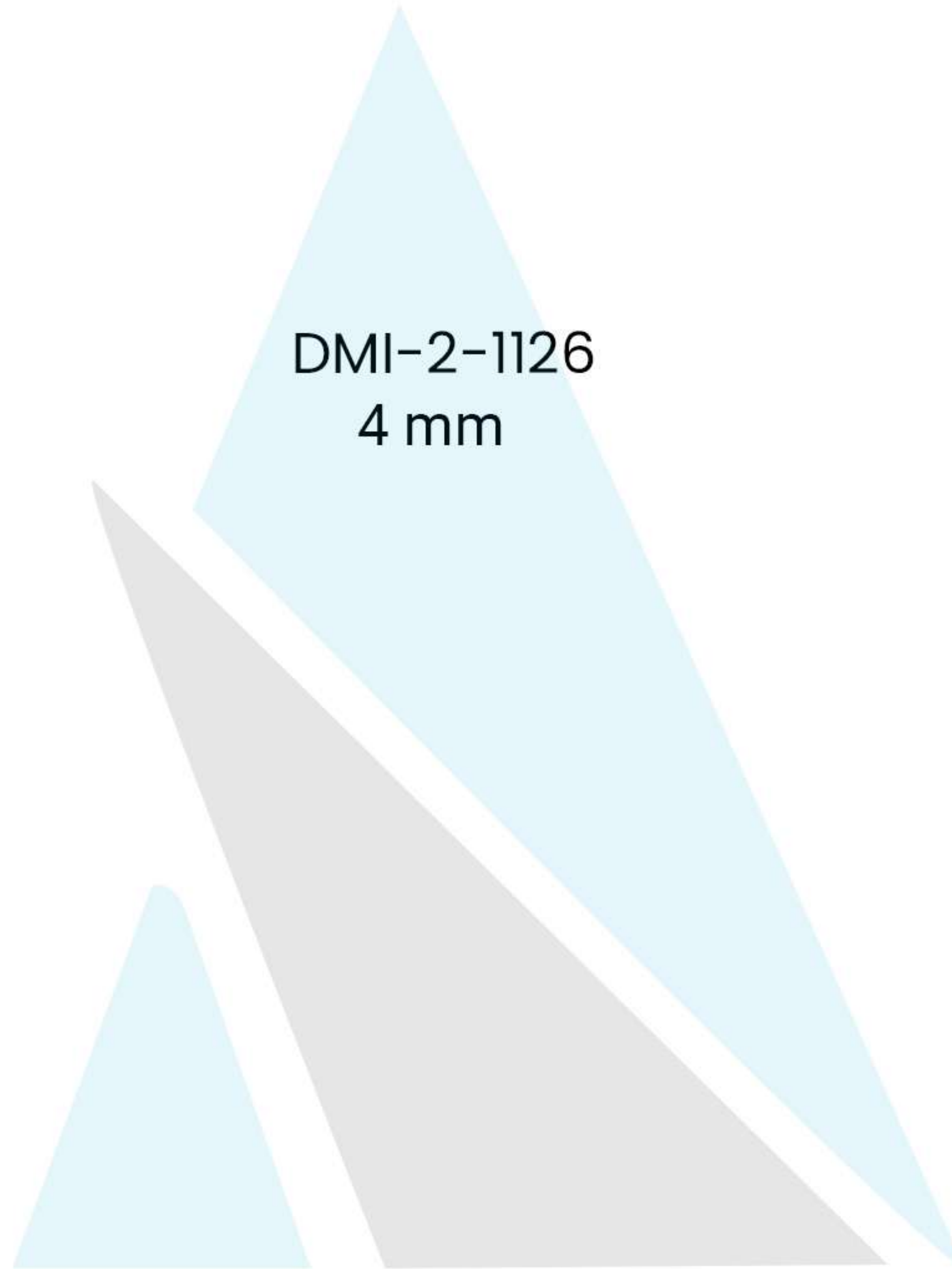

DMI-2-1128
6 mm



DMI-2-1129
3 mm



DMI-2-1130
4 mm

**Bone Currettes, Bone Files, Bone
Chisels, Bone Mallets**



DMI-2-1131
5 mm



DMI-2-1132
6 mm



DMI-2-1133
3 mm

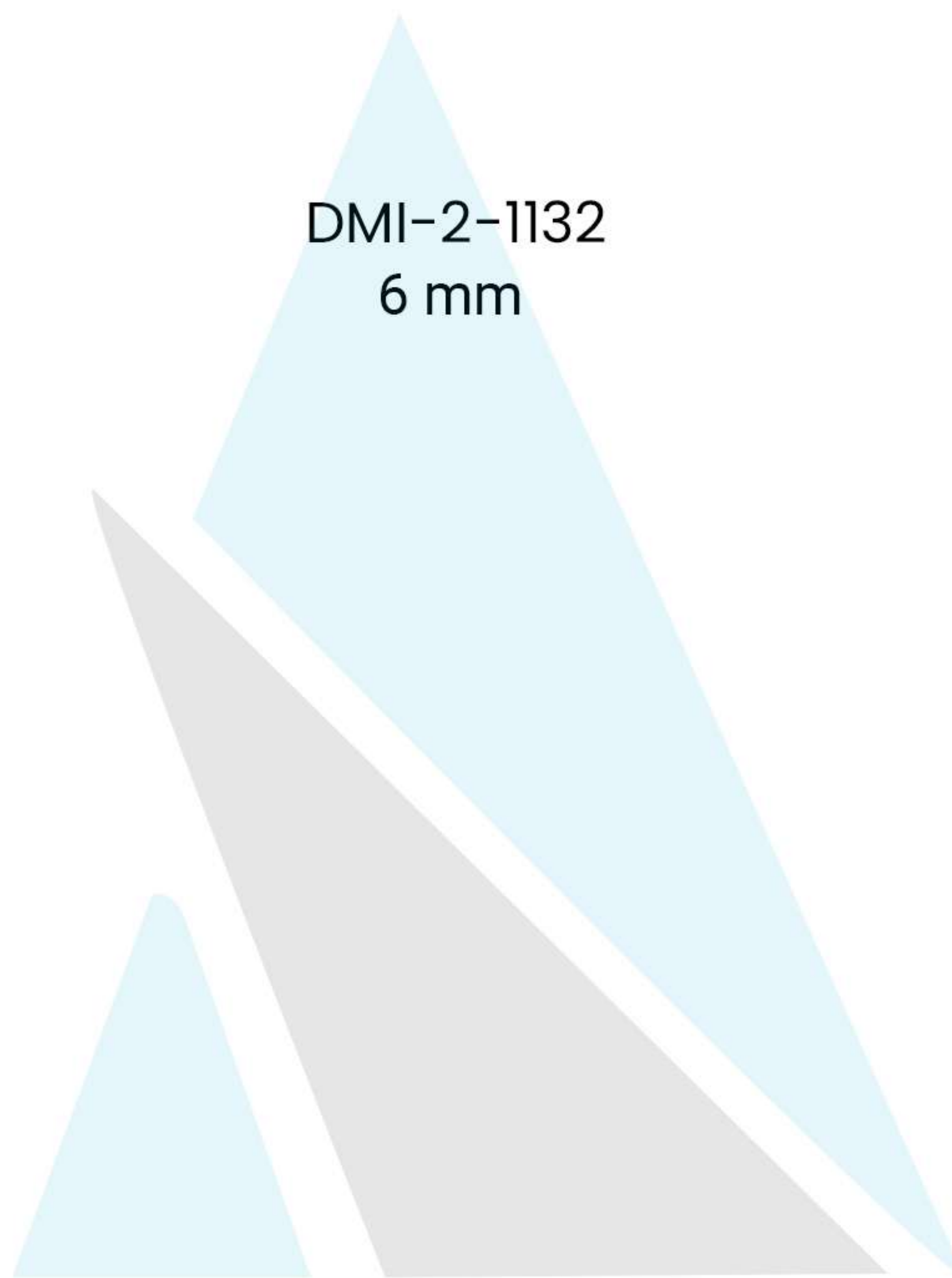

DMI-2-1134
4 mm



DMI-2-1135
5 mm



DMI-2-1136
6 mm

Bone Curettes, Bone Files, Bone Chisels, Bone Mallets



DMI-2-1137
3 mm



DMI-2-1138
4 mm



DMI-2-1139
5 mm



DMI-2-1140
6 mm



DMI-2-1141
PARTSCH 19 cm



DMI-2-1142
MEAD 19,5 cm



DMI-2-1143
MEAD 17 cm

Crown Removers, Crown Instruments



DMI-2-1201
Crown Removers,
Crown Instruments



DMI-2-1202
Crown Removers,
Crown Instruments



DMI-2-1203
Crown Removers,
Crown Instruments



DMI-2-1204
Crown Removers,
Crown Instruments

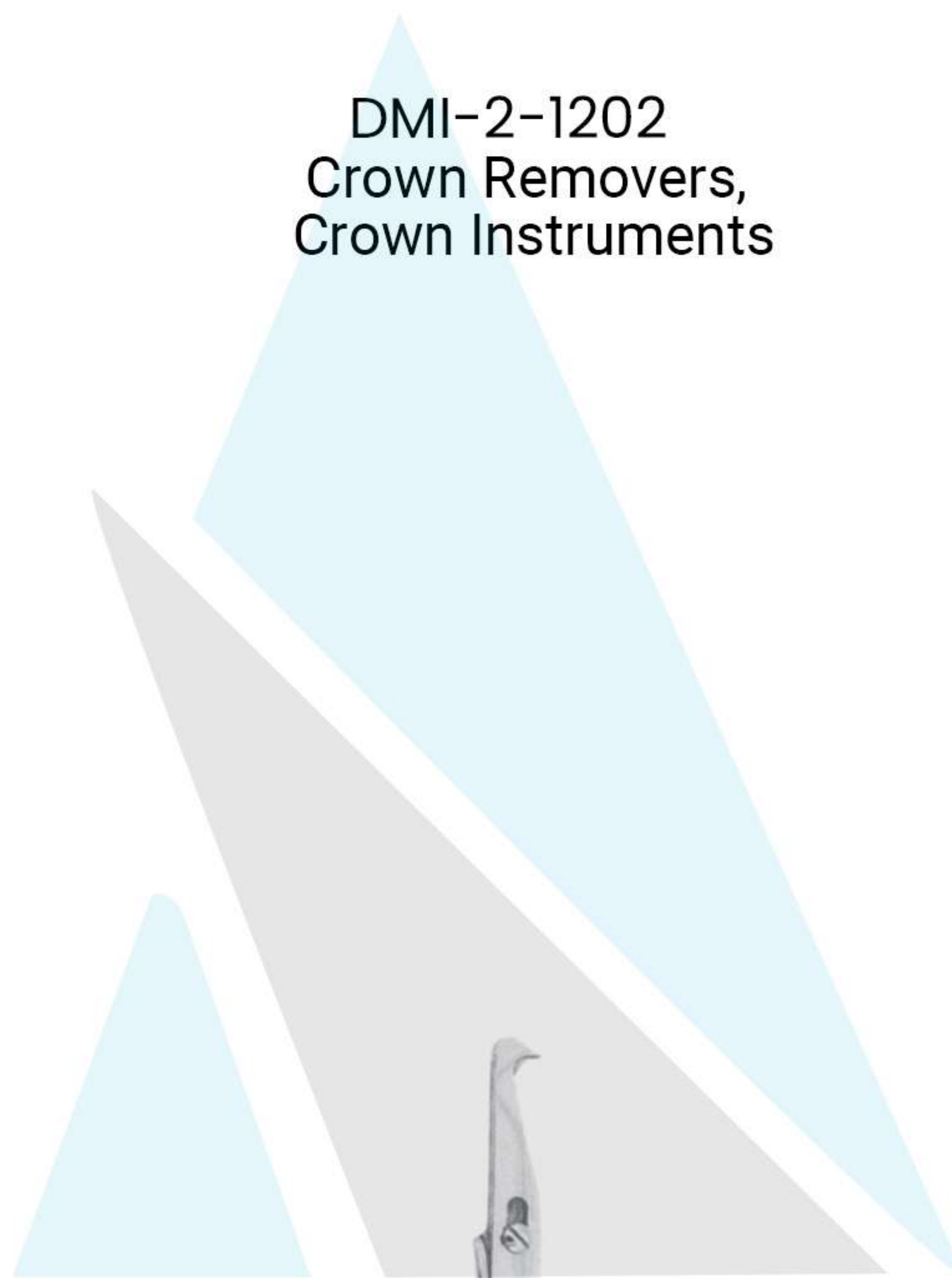

DMI-2-1205
Crown Spreader, Crown Remove.
Special instrument for crown spreading
after separating, simple and safe operation.



DMI-2-1206
Crown Removers,
Crown Instruments

Crown Removers, Crown Instruments



DMI-2-1207
Crown Removers,
Crown Instruments



DMI-2-1208
Crown Removers,
Crown Instruments



DMI-2-1209
Crown Removers,
Crown Instruments

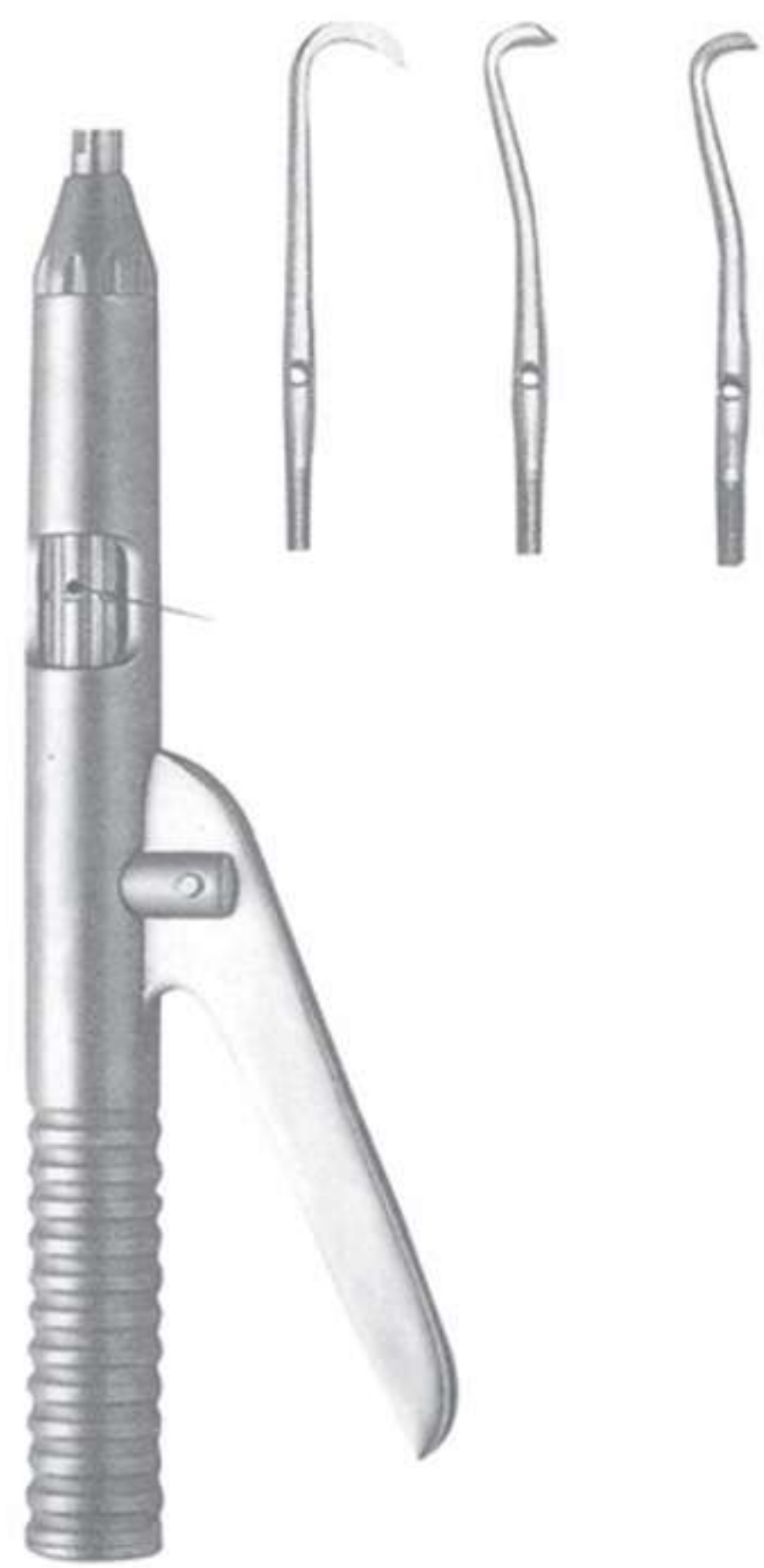

DMI-2-1210
Crown Remover



DMI-2-1211
Crown Remover



DMI-2-1212
Crown Removers,
Crown Instruments



DMI-2-1213
single loop with adapter



DMI-2-1214
KEY/9



DMI-2-1215
Crown & Bridge Holding
Forceps With Support Ring



DMI-2-1216
WYNMAN Crown
Gripper, CARB-N-SERT

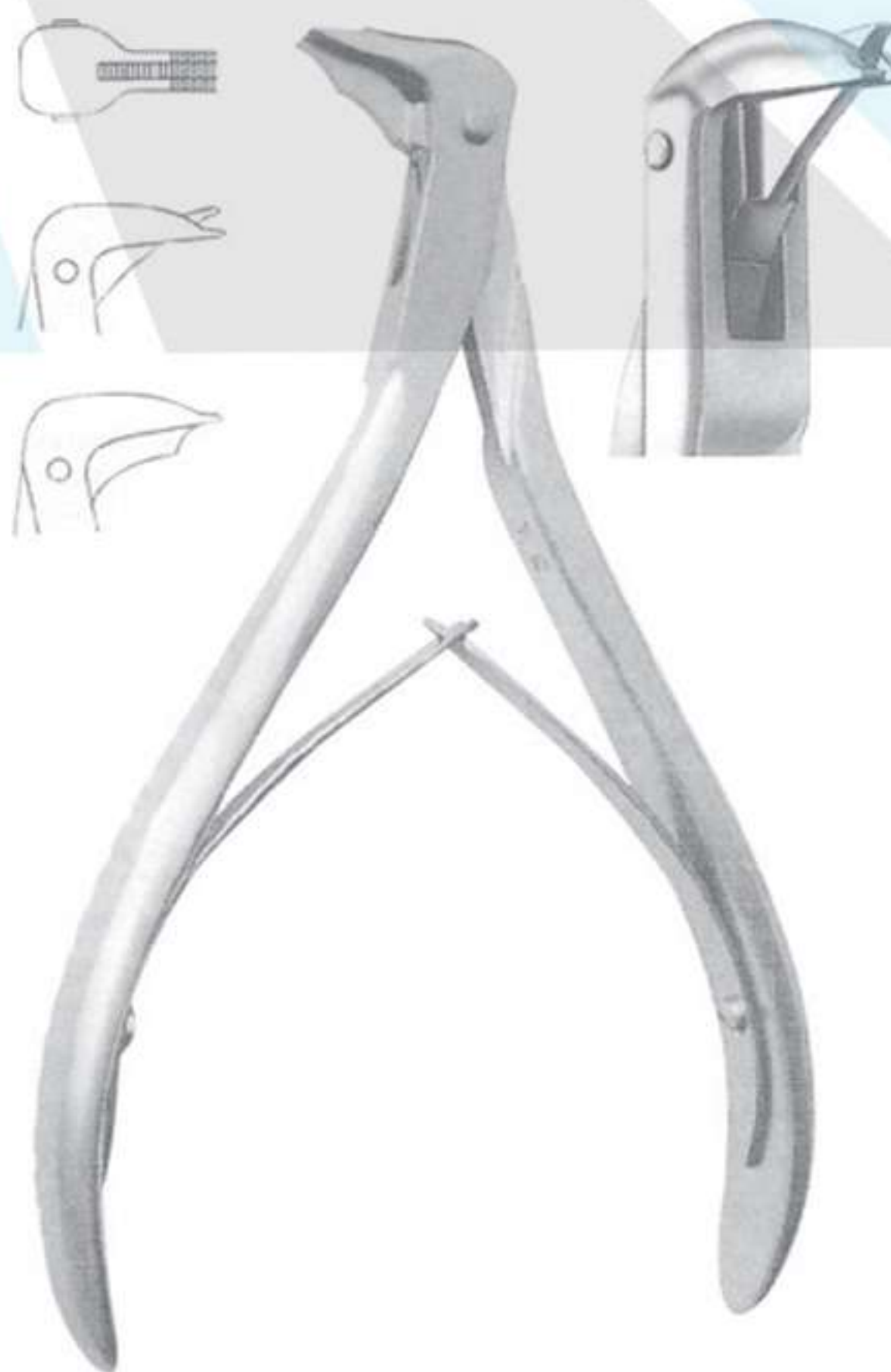

DMI-2-1217
Crown opener



DMI-2-1218
Universal Hollow Handle



DMI-2-1219
Fig.2



DMI-2-1220
Fig.3



DMI-2-1221
Fig.4



DMI-2-1222
Plaster Shear 210 mm



DMI-2-1223
BOHM 16 cm



DMI-2-1224
Crown Removing Plier 14 cm



DMI-2-1225
MONTFORT 18 CM

Impants & Measuring

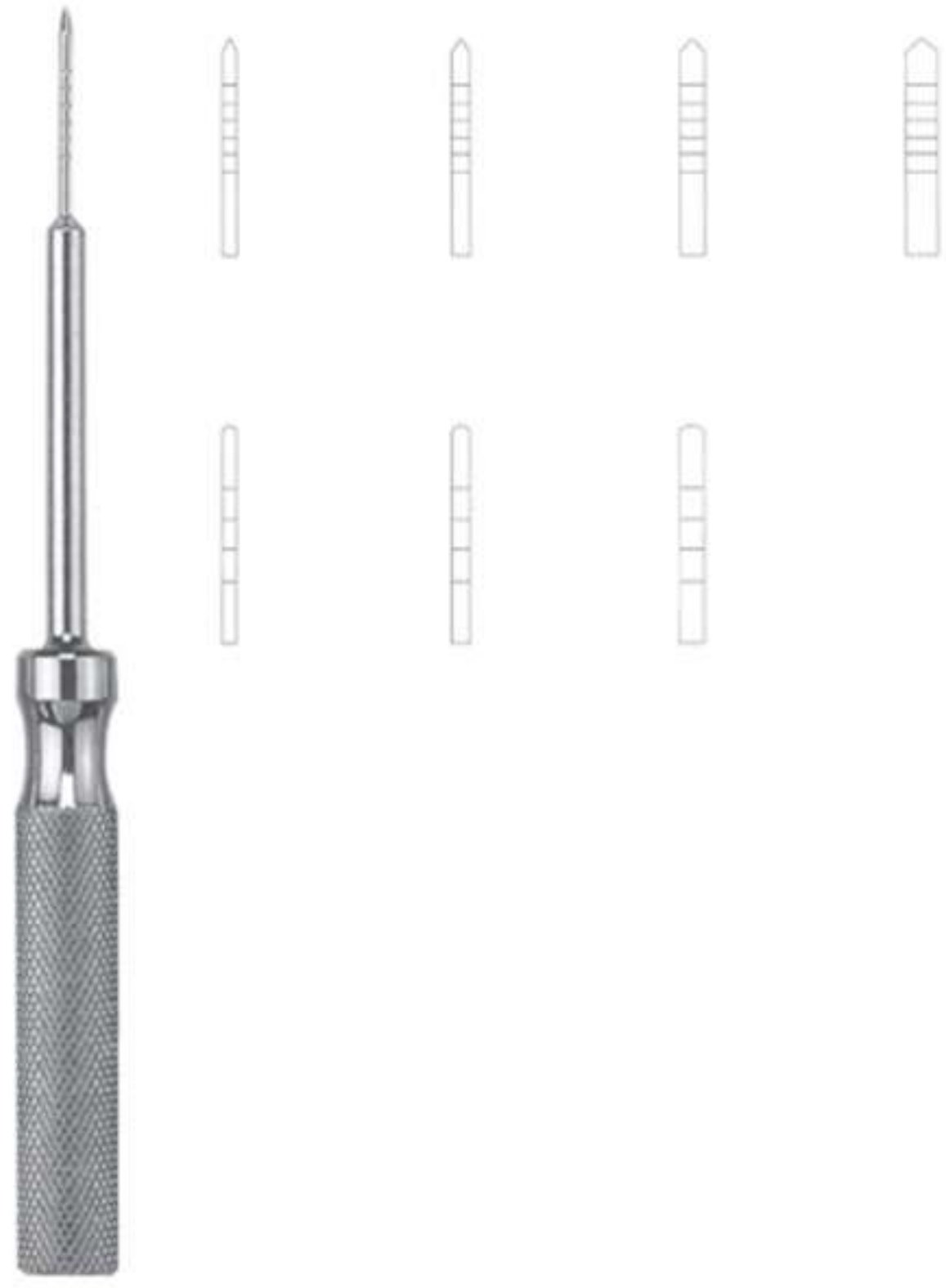

DMI-2-1301
1P 150 mm 1P 150 mm



DMI-2-1302
Fig. 1 155 mm

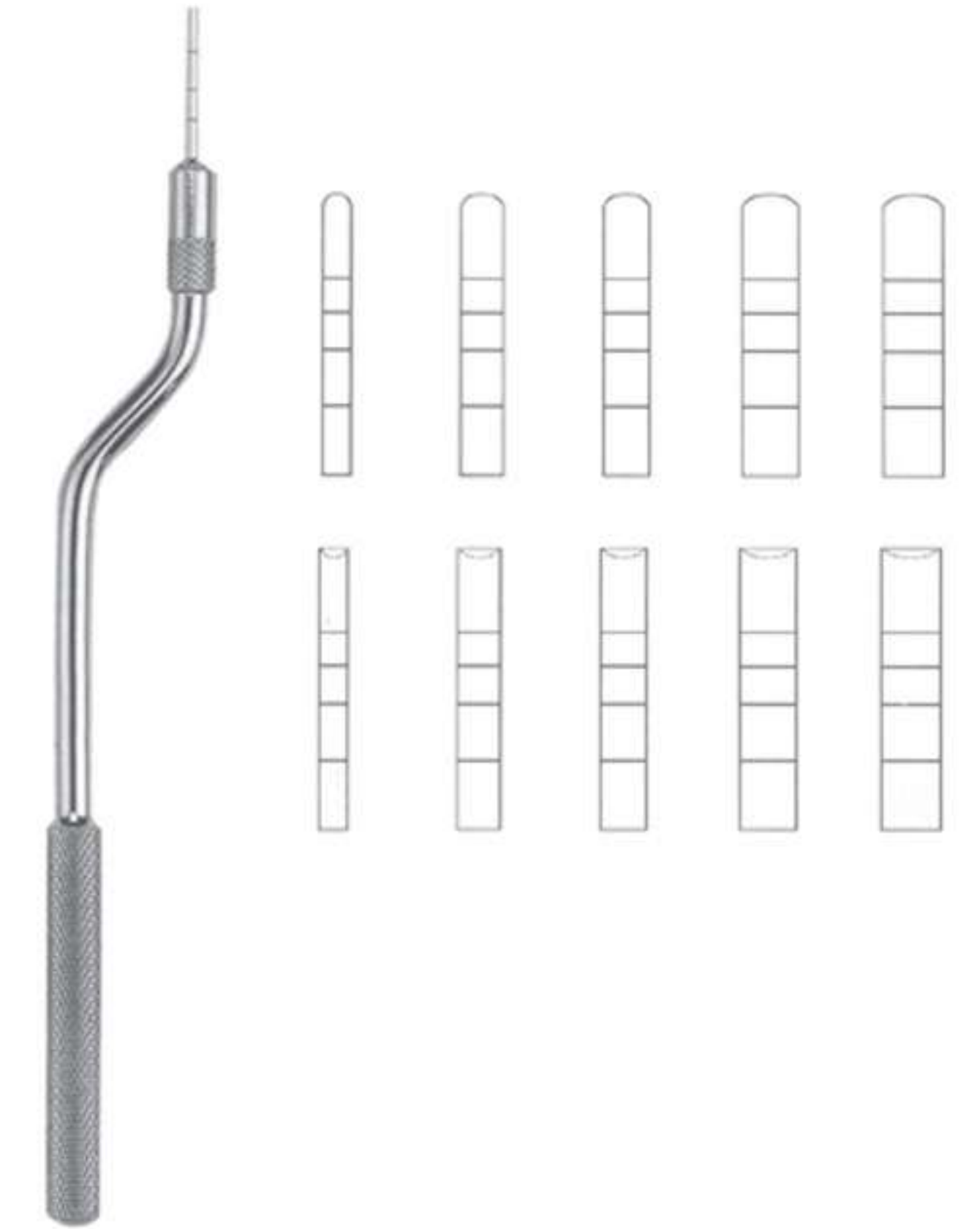

DMI-2-1303
Fig. 1B 165 mm

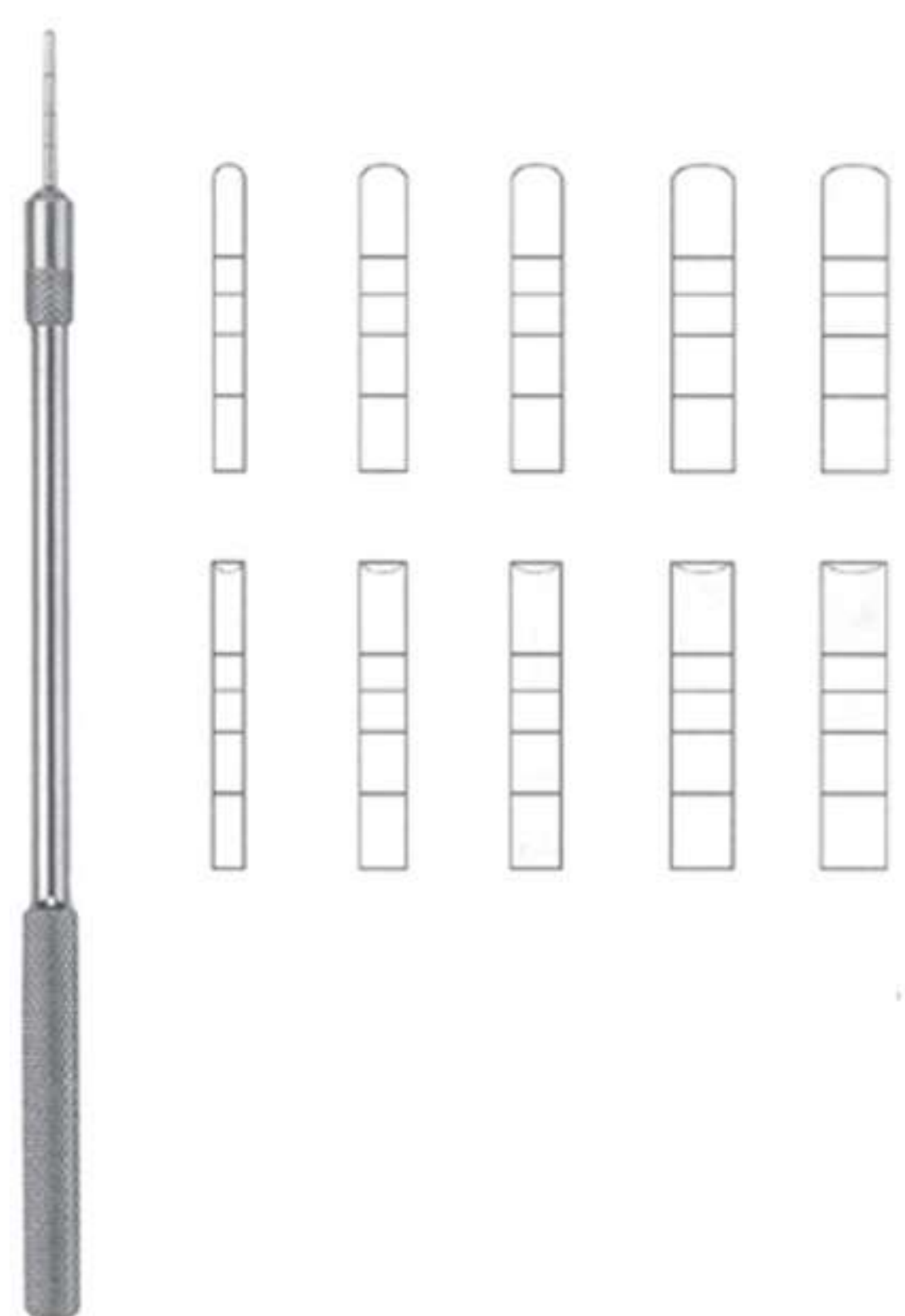
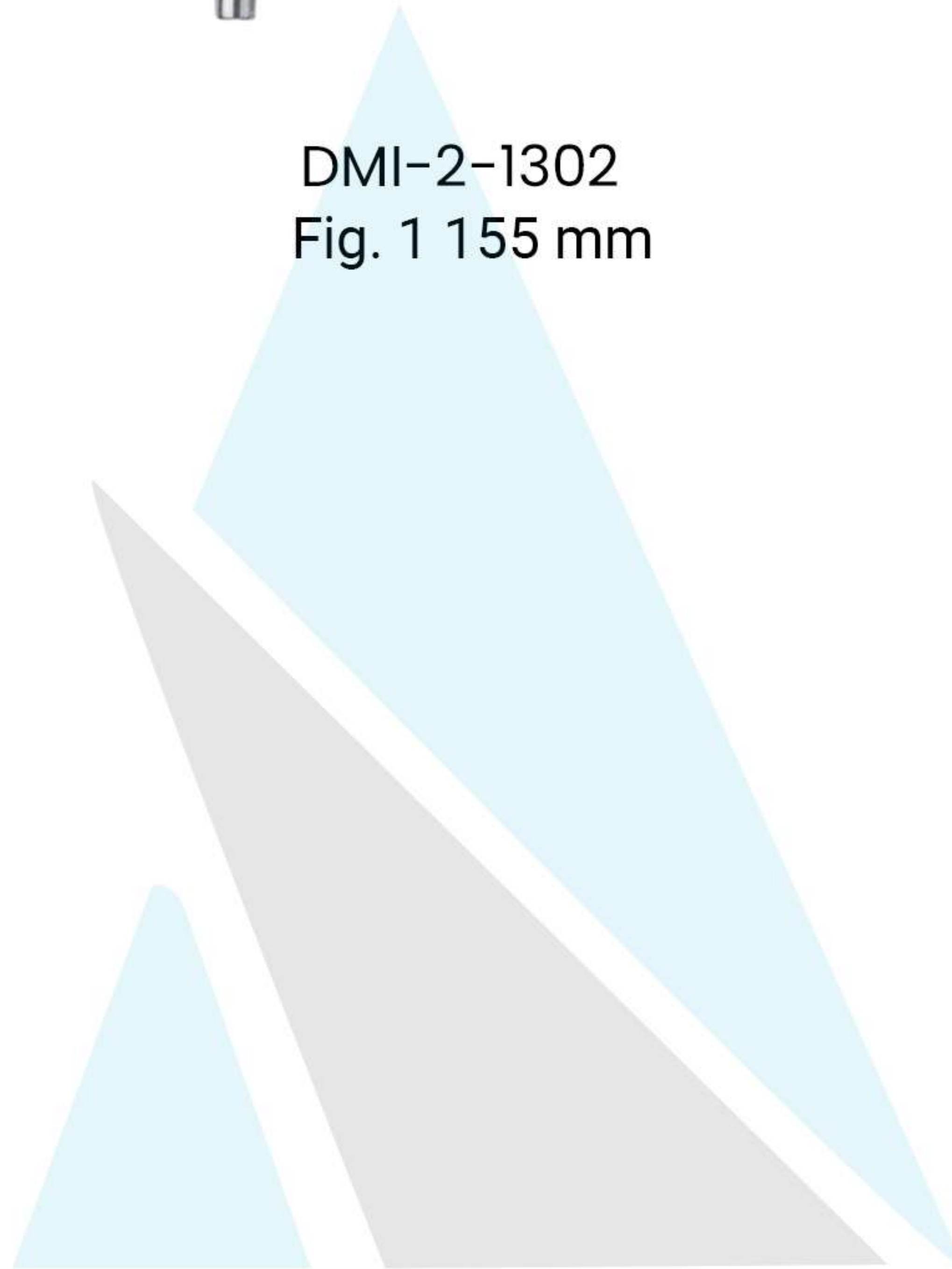

DMI-2-1304
Fig. 1 155 mm

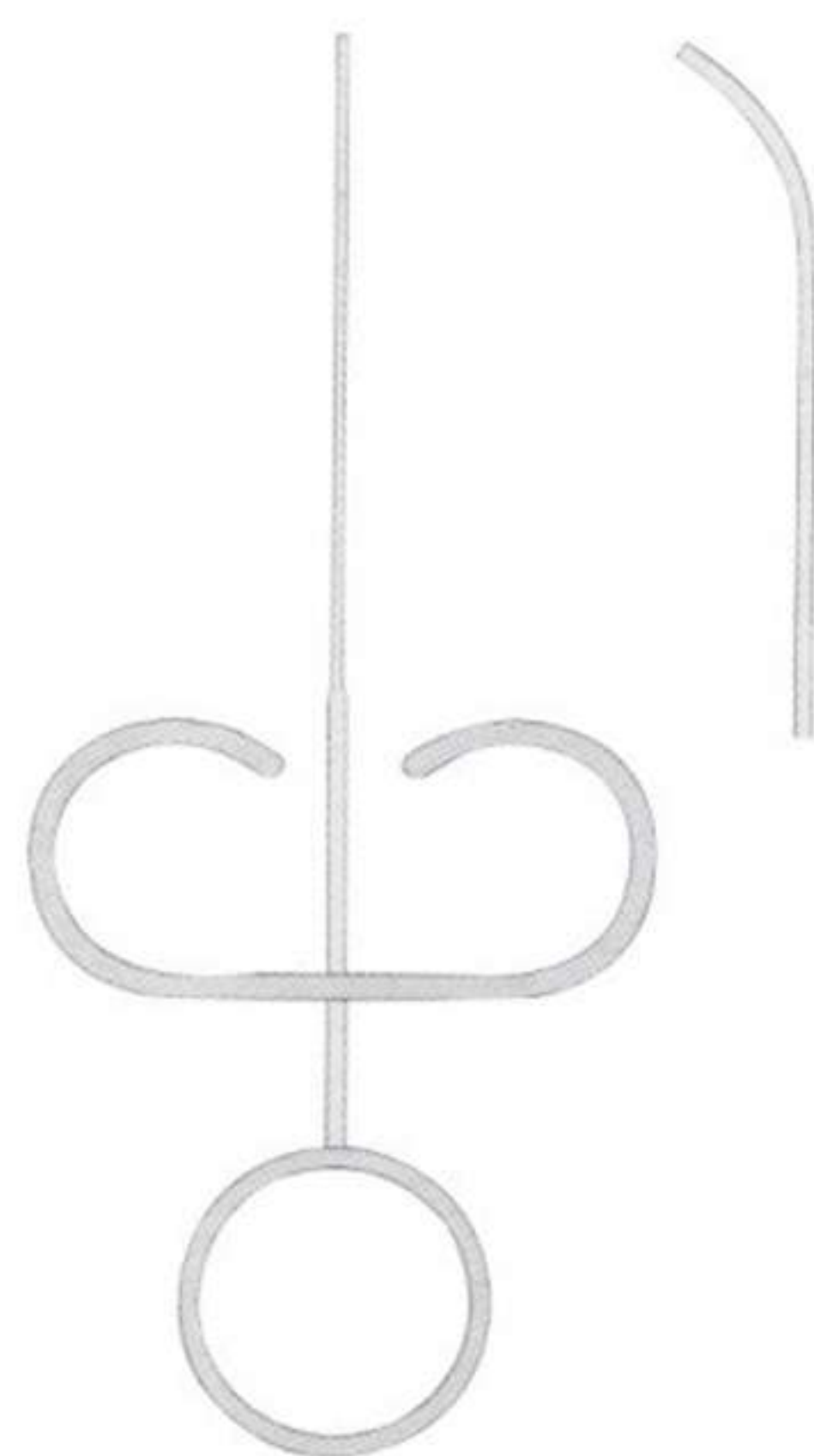

DMI-2-1305
130 mm

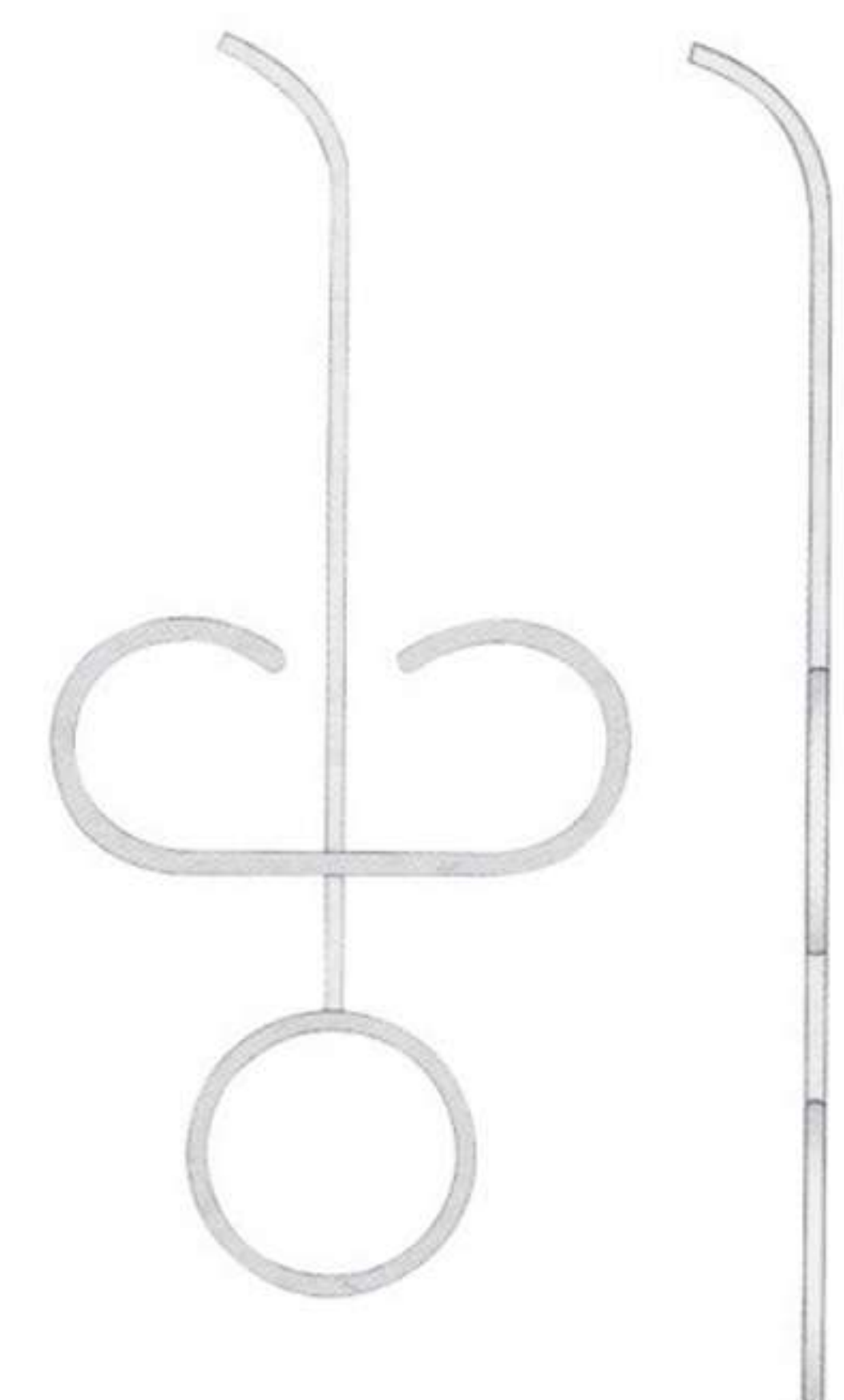

DMI-2-1306
1.8 mm 130 mm

Impants & Measuring



DMI-2-1307
150 mm



DMI-2-1308
150 mm



DMI-2-1309
150 mm

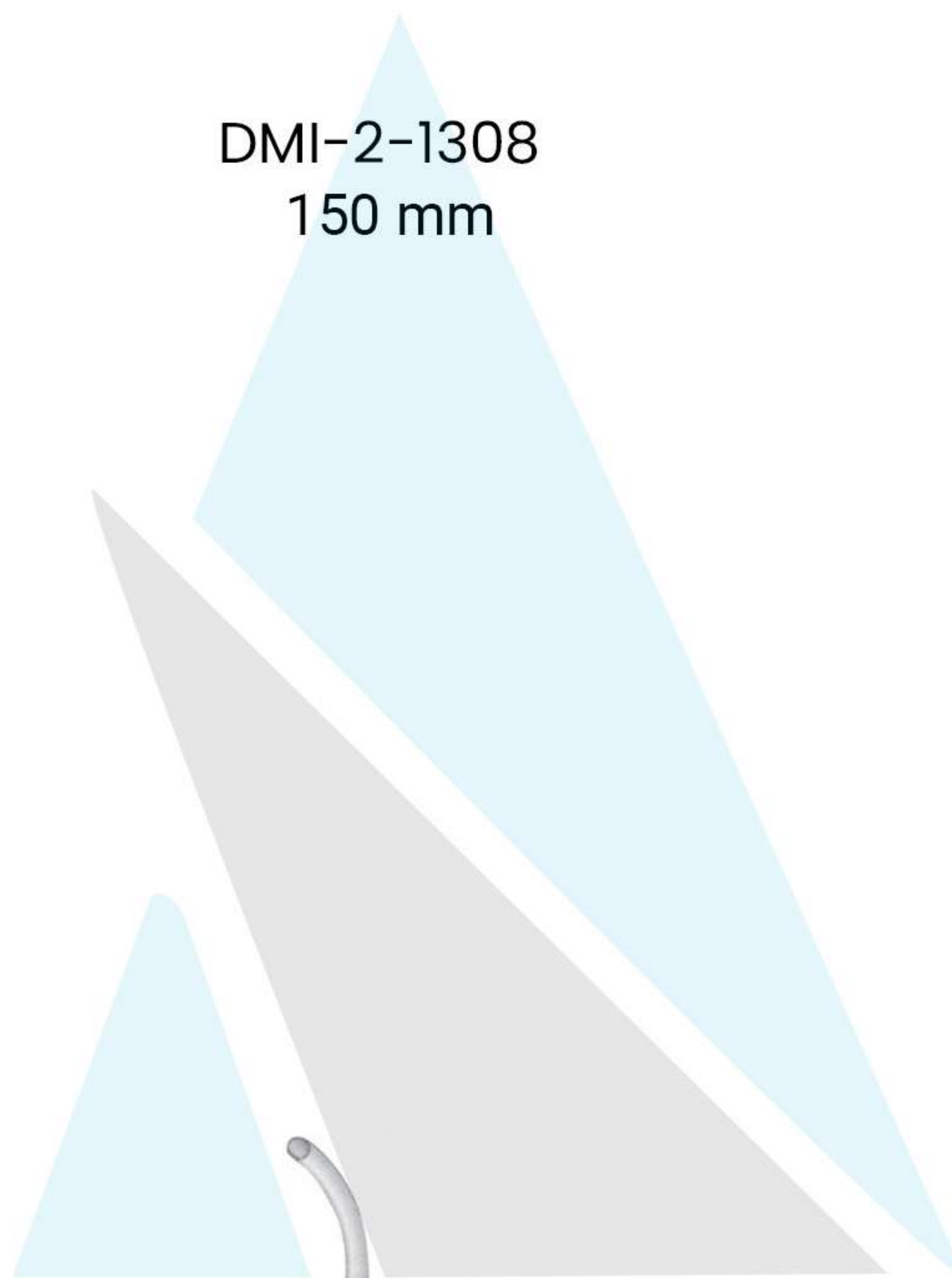

DMI-2-1310
2.5 150 mm



DMI-2-1311
4.4 150 mm



DMI-2-1312
Grinders for autogenous

Impants & Measuring



DMI-2-1313
35 mm



DMI-2-1314
Fig. 1 170 mm



DMI-2-1315
Fig. 2 175 mm

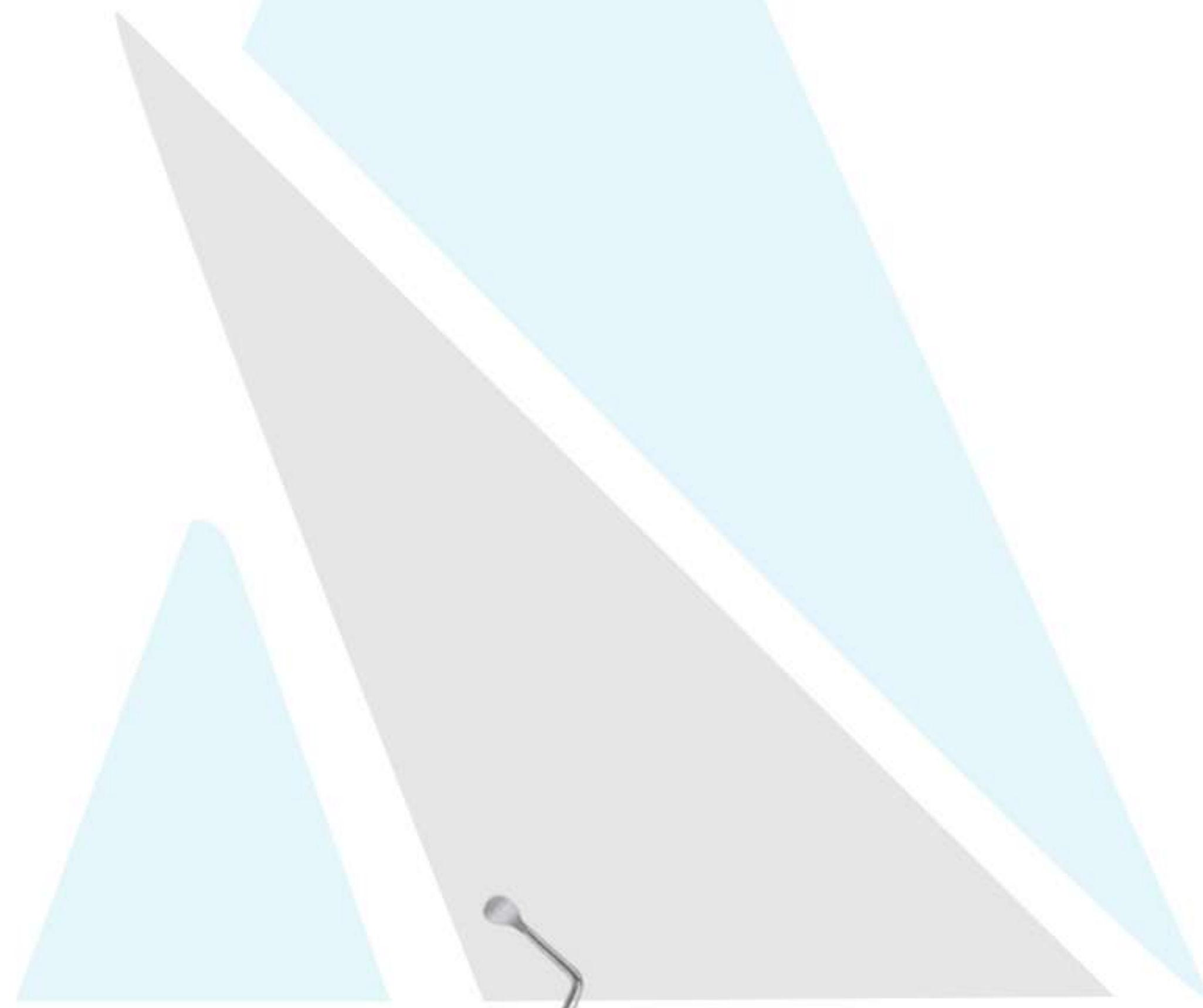

DMI-2-1316
Fig. 3 170 mm



DMI-2-1317
LUCAS Fig. 88 170 mm



DMI-2-1318
Impants & Measuring



DMI-2-1319
Fig. 2



DMI-2-1320
3.5 mm



DMI-2-1321
6 mm 5 mm

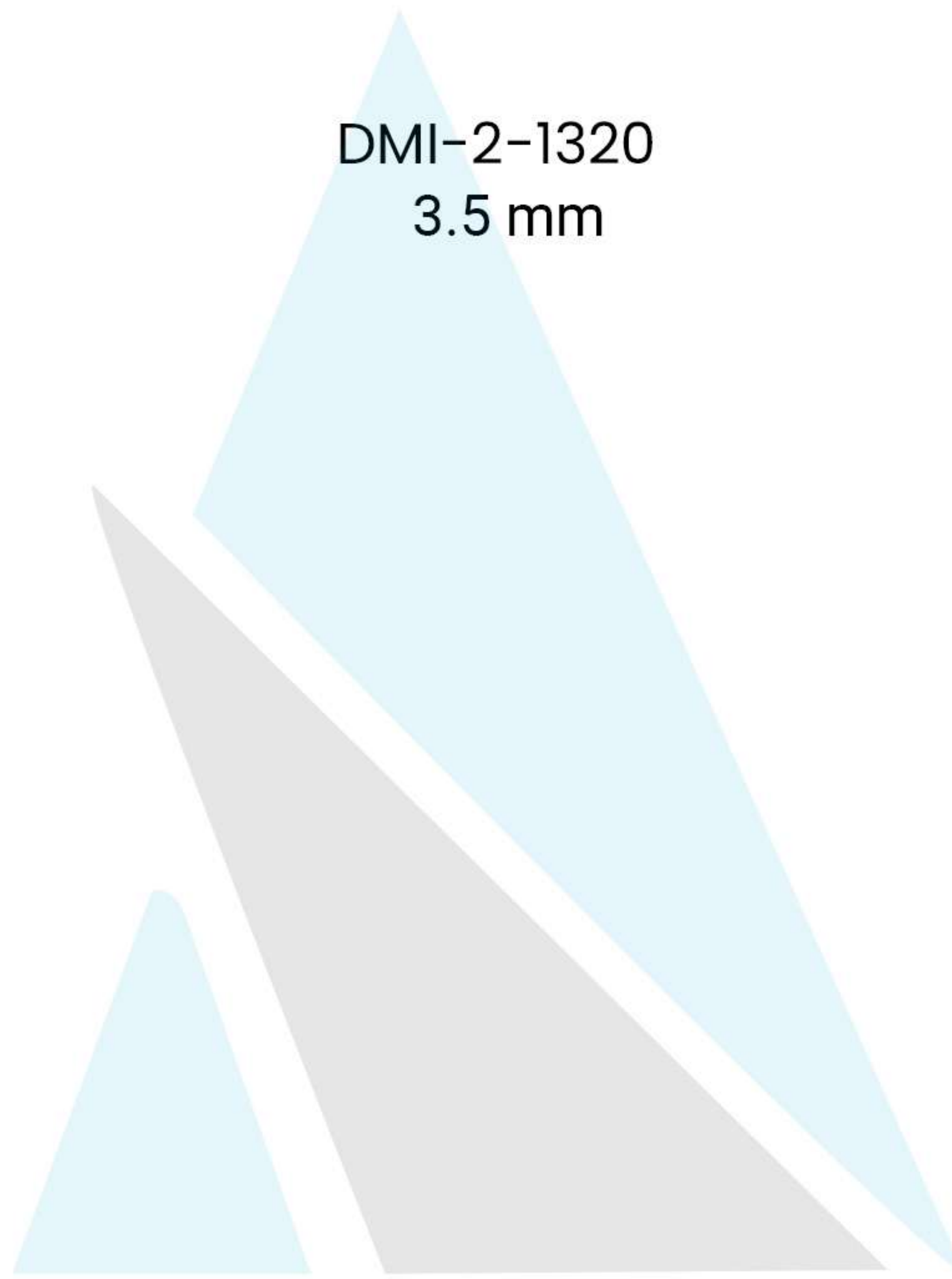

DMI-2-1322
8.5 mm 7.55 mm



DMI-2-1323
11 mm 10 mm



DMI-2-1324
Fig.1



DMI-2-1325
Fig.2



DMI-2-1326
Fig.3



DMI-2-1327
Fig.4

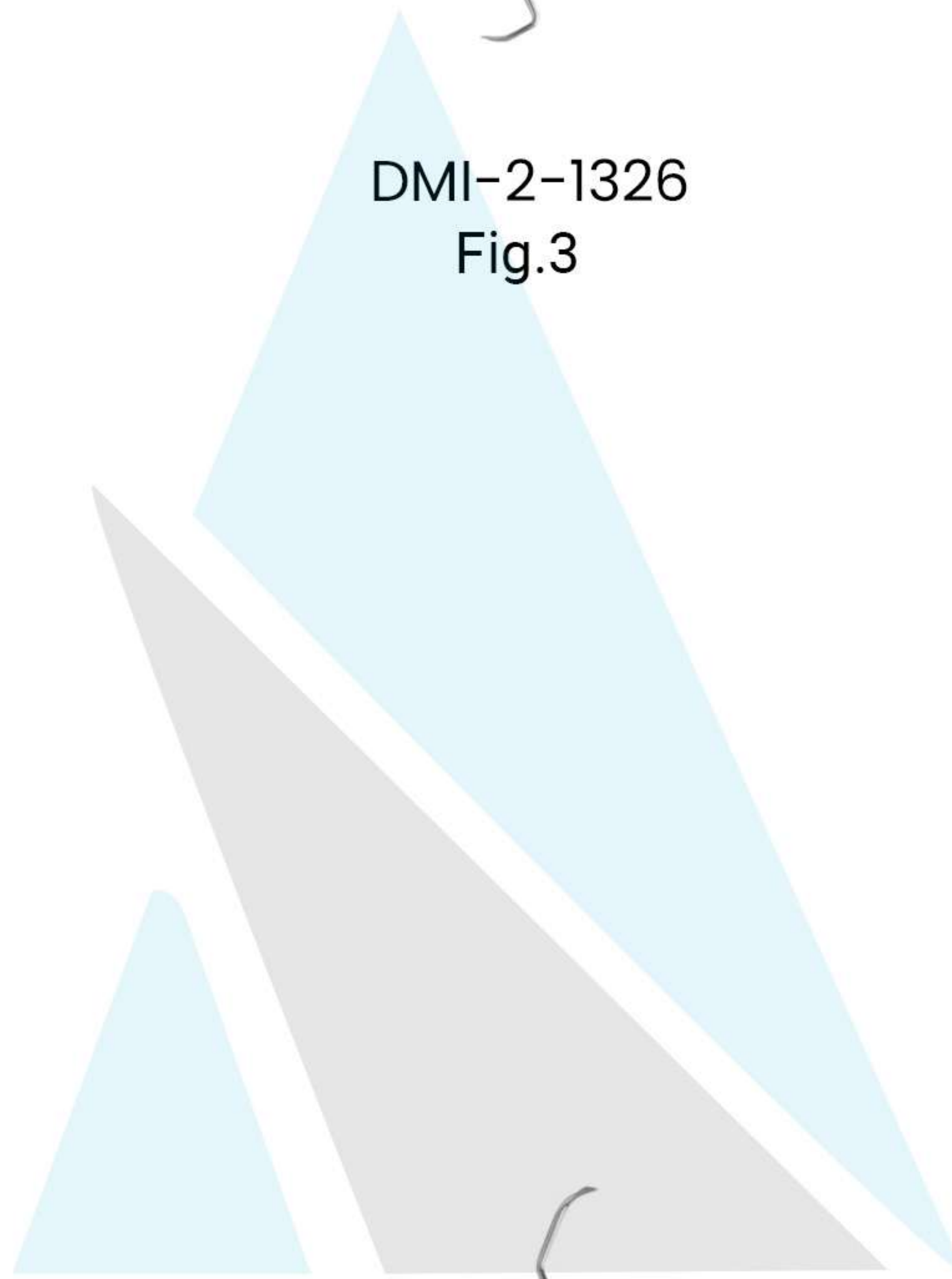

DMI-2-1328
Fig.5



DMI-2-1329
Fig.6



DMI-2-1330



DMI-2-1330
Fig.8



DMI-2-1332
Fig.9

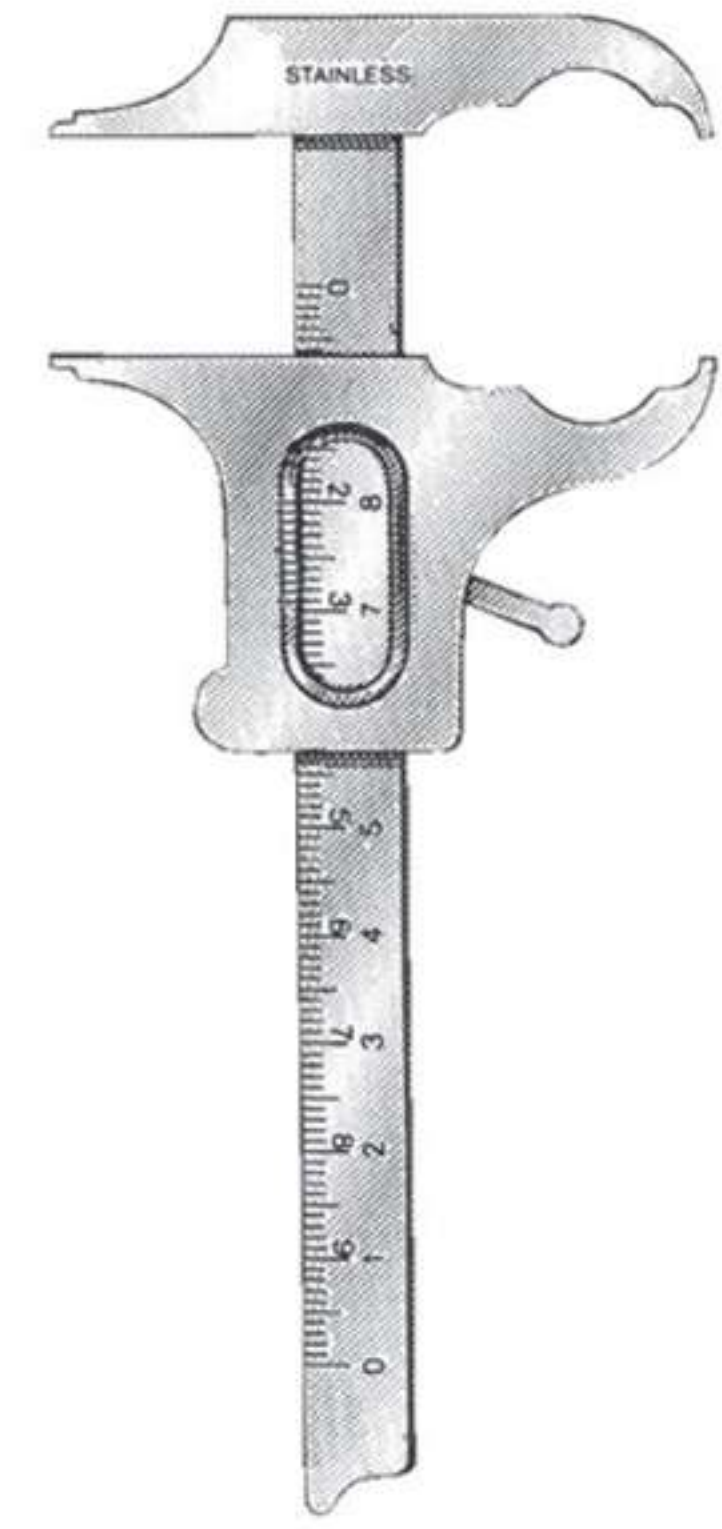

DMI-2-1333
BOLEY Gauge

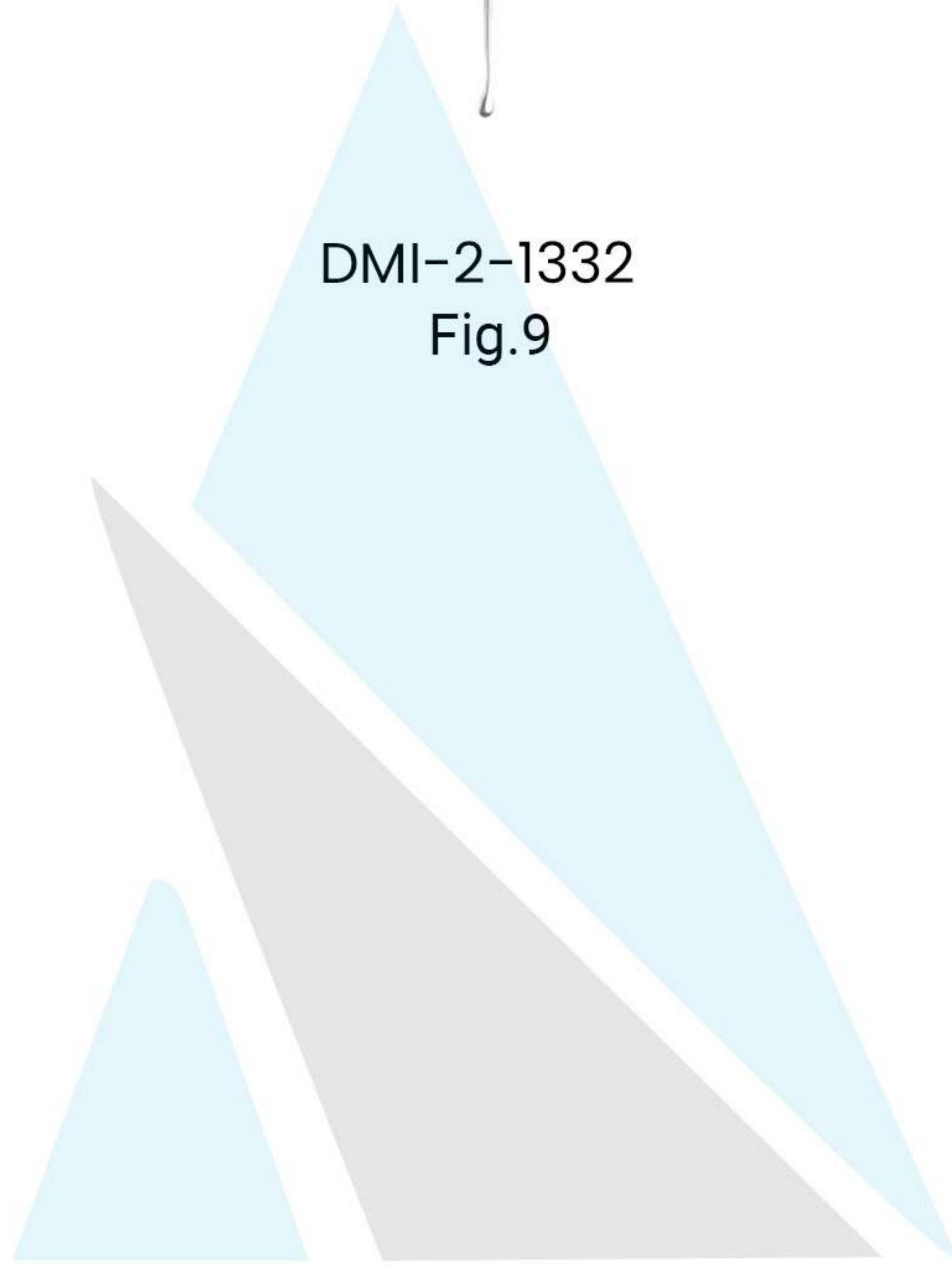

DMI-2-1334
ZURICHER 130 mm



DMI-2-1335
VERNIER 12 cm



DMI-2-1336
VERNIER

Impants & Measuring



DMI-2-1337
Height Gauge Wick Type

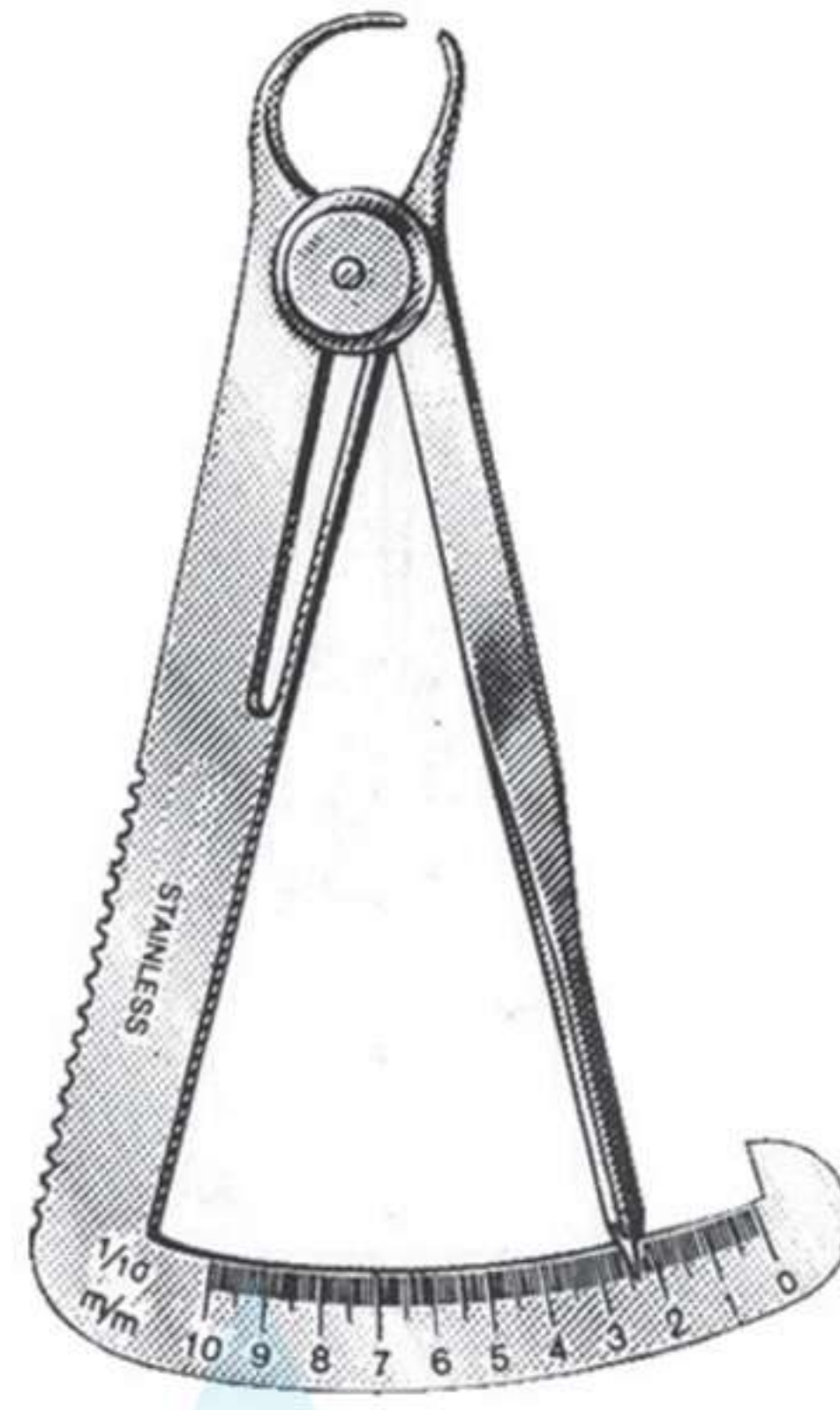

DMI-2-1338
LWANSON Crown Gauge



DMI-2-1339
CASTROVIEJO'S Sclerer Marker



DMI-2-1340
Spring Bow Divider 6" Radius



DMI-2-1341
ALBEE

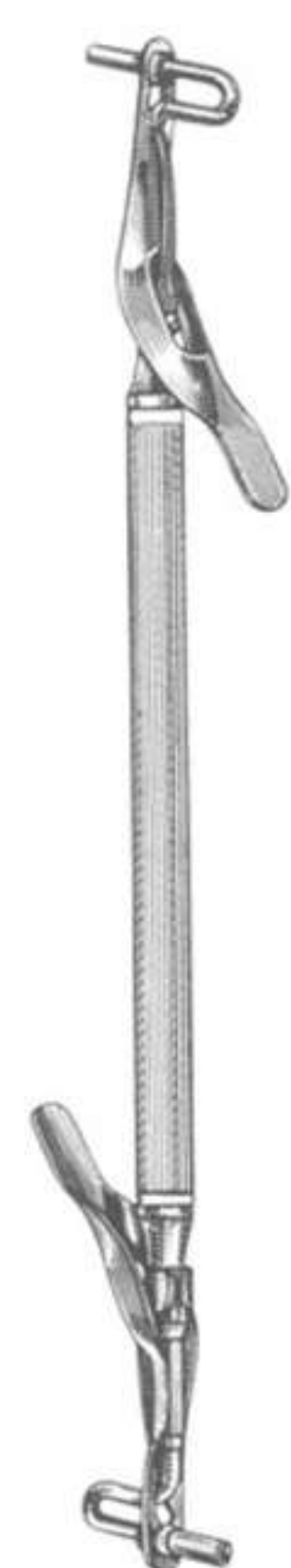

DMI-2-1401
Medium-Large 20 cm

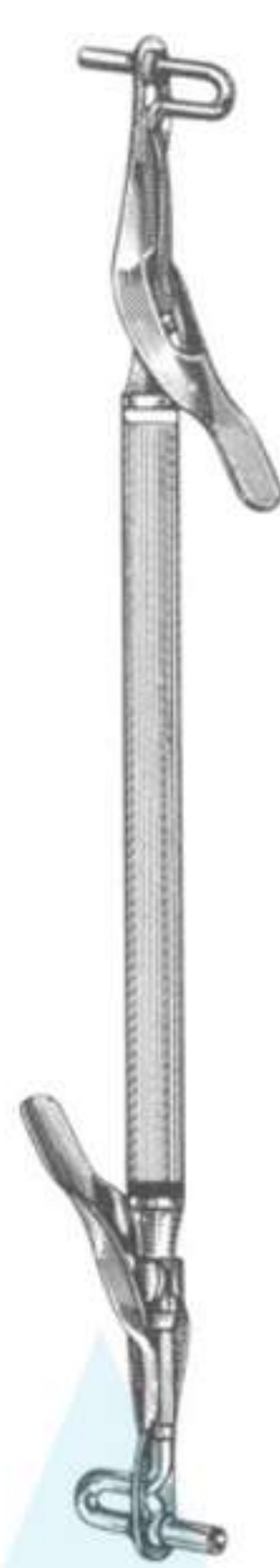

DMI-2-1402
Medium-Jumbo 20 cm

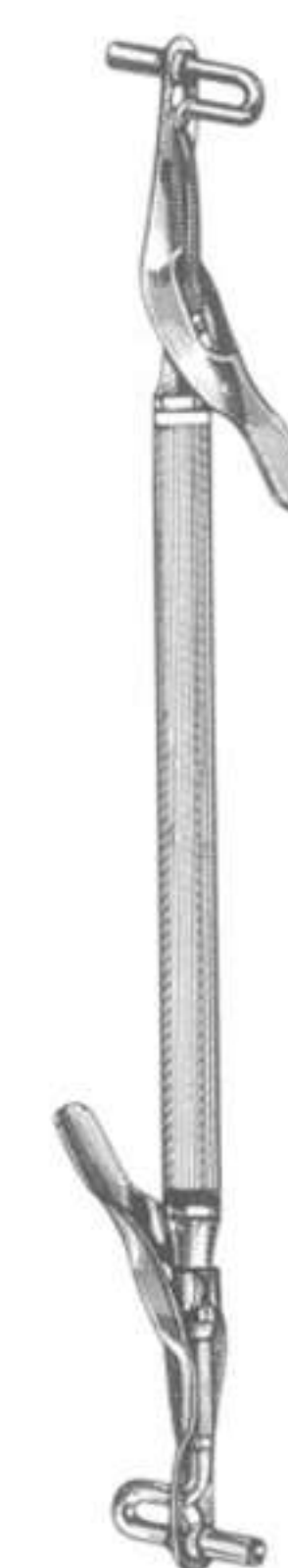

DMI-2-1403
Large-Jumbo 20 cm



DMI-2-1404
Jumbo-Jumbo 20 cm

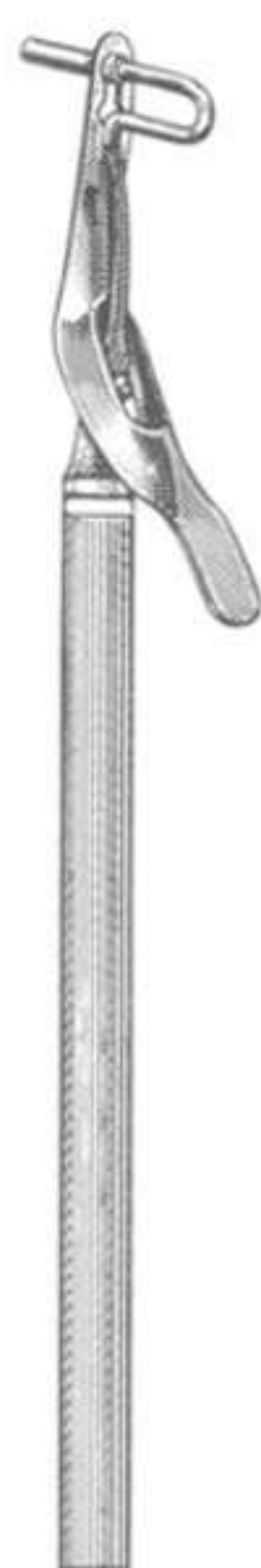

DMI-2-1405
Regular-Jumbo Silicon Grip 20 cm

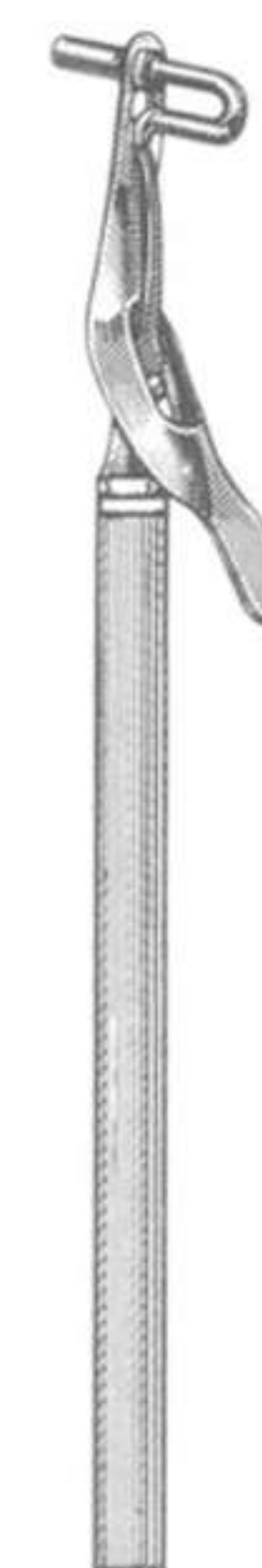

DMI-2-1406
Medium 15.5 cm

**Amalgam Guns & Carriers,
Retainers, Bands, Strip Holders, Napkin**

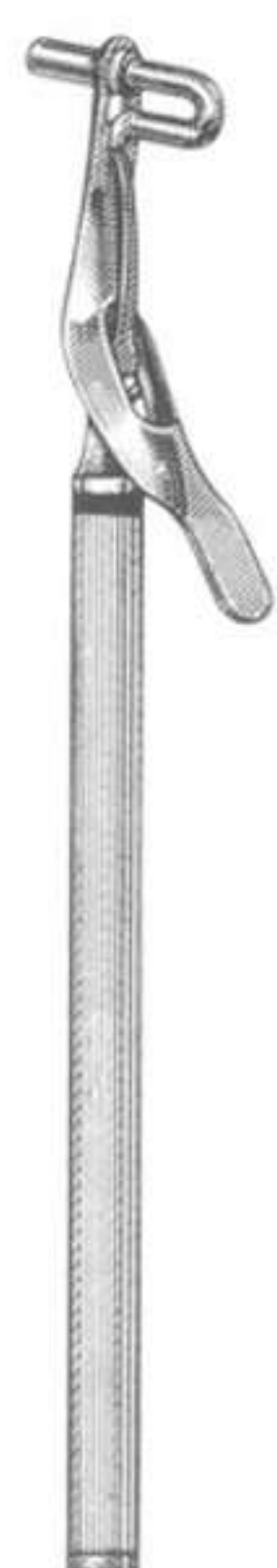

DMI-2-1407
Large 15.5 cm

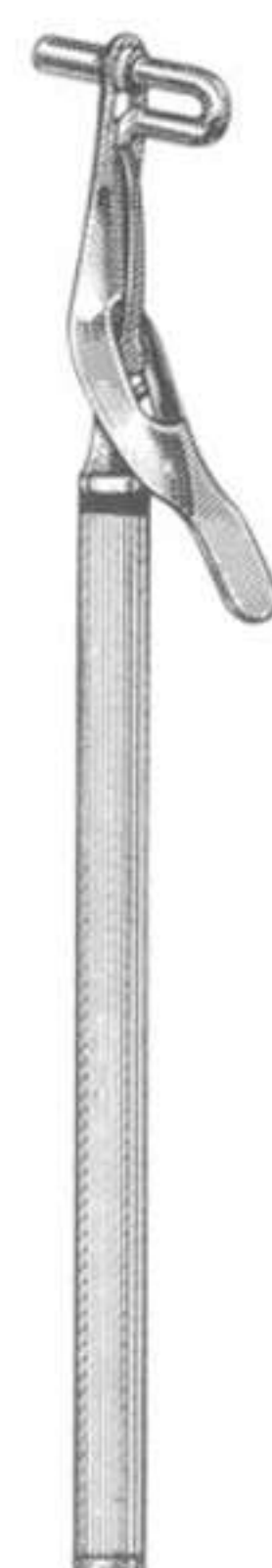

DMI-2-1408
Jumbo 15.5 cm

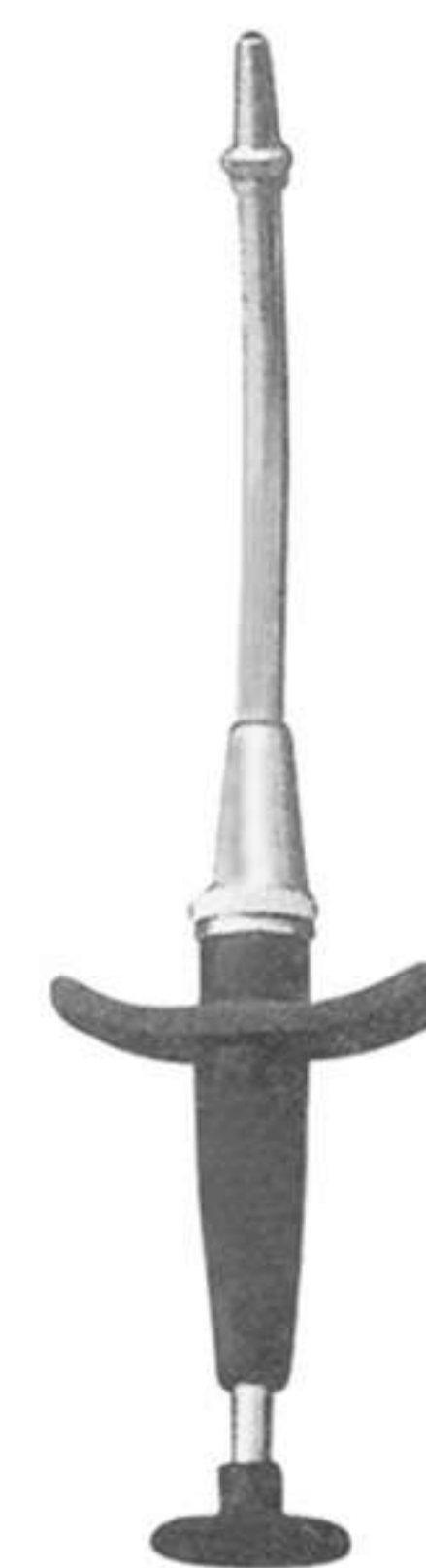

DMI-2-1409
145 mm

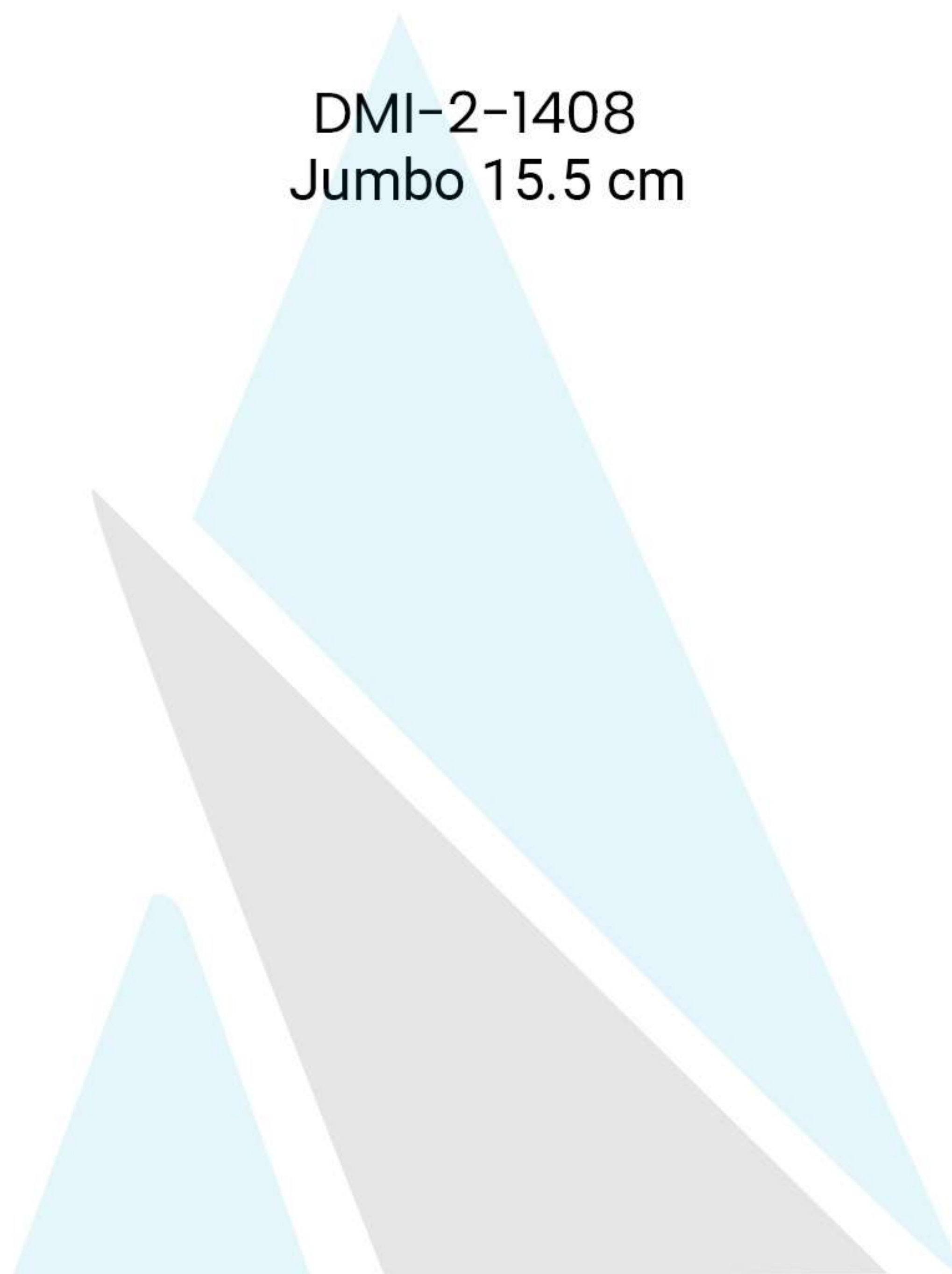

DMI-2-1410
130 mm



DMI-2-1411
Straight 15 cm



DMI-2-1412
15 cm

**Amalgam Guns & Carriers,
Retainers, Bands, Strip Holders, Napkin**



DMI-2-1413
15 cm 90



DMI-2-1414
Amalgam Well Non Skid Base



DMI-2-1415
No. 1



DMI-2-1416
No. 8

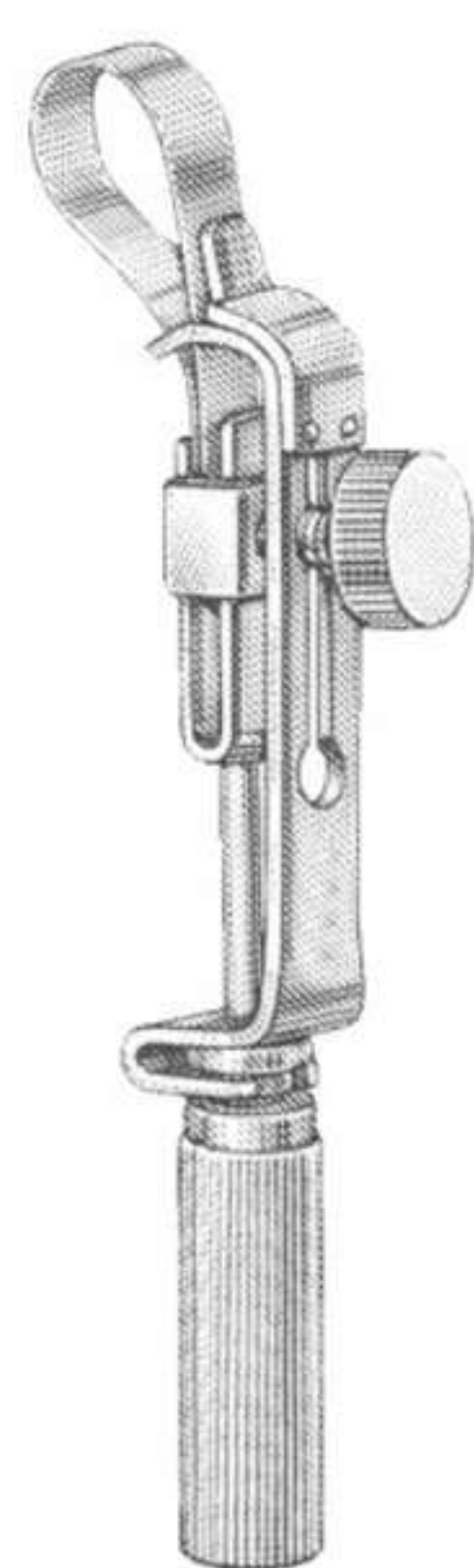

DMI-2-1417
No. 9

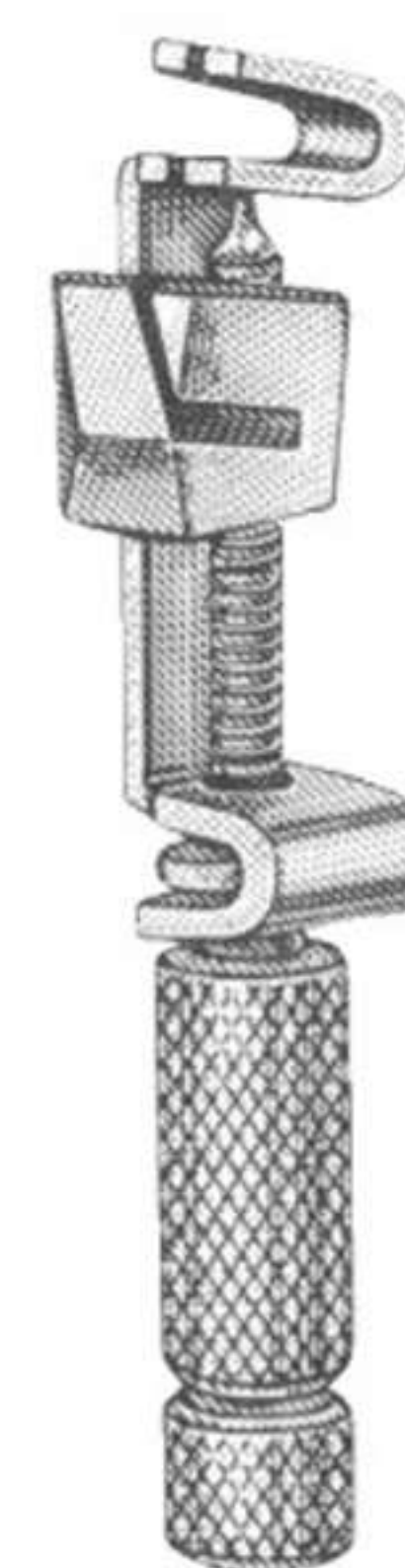

DMI-2-1418
JUNIOR-CA

**Amalgam Guns & Carriers,
Retainers, Bands, Strip Holders, Napkin**

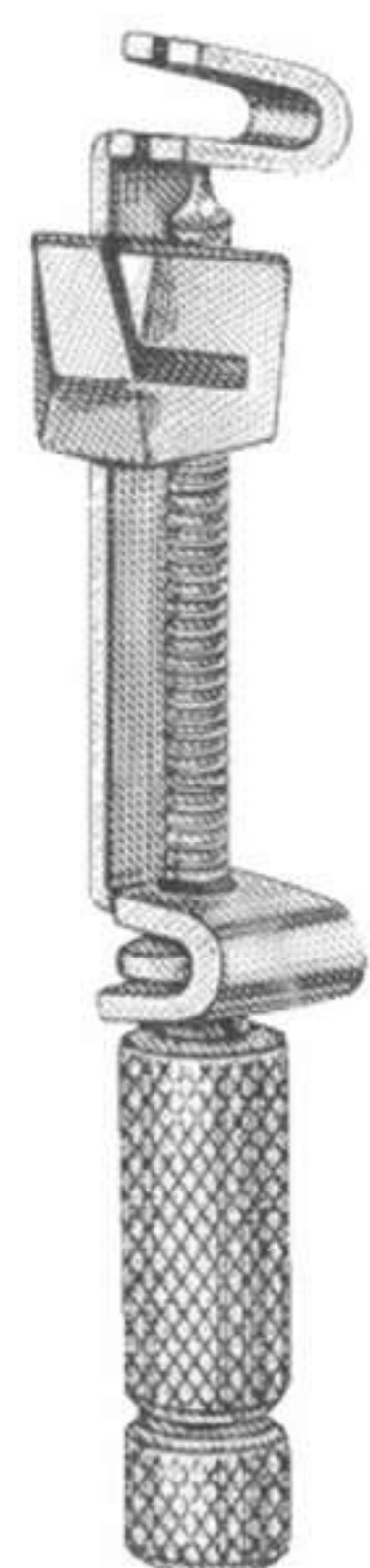

DMI-2-1419
SENIOR-CA

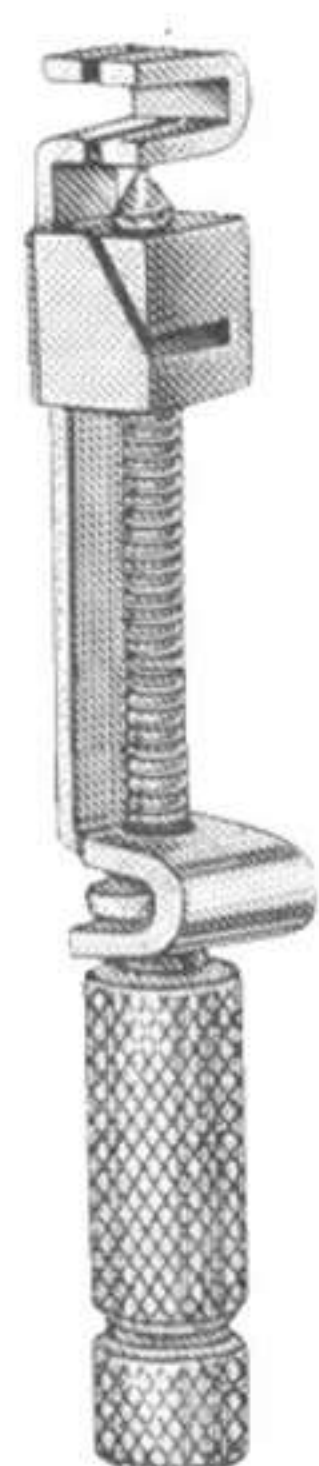

DMI-2-1420
UNIVERSAL



DMI-2-1421
.0015", .002"

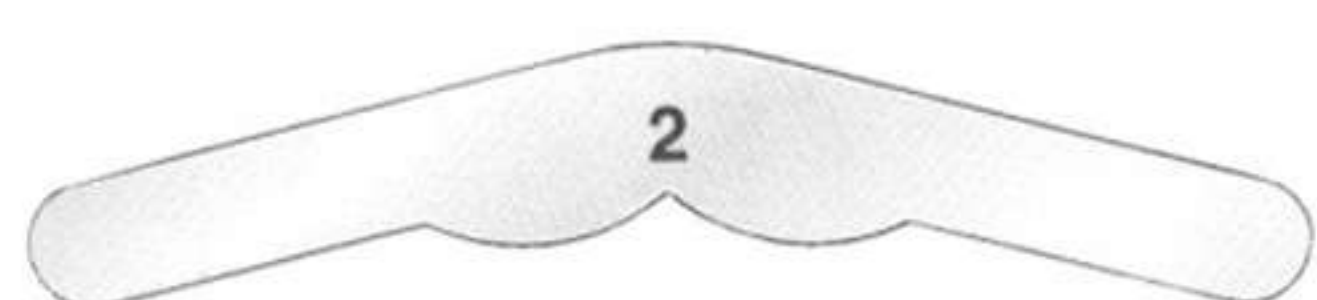
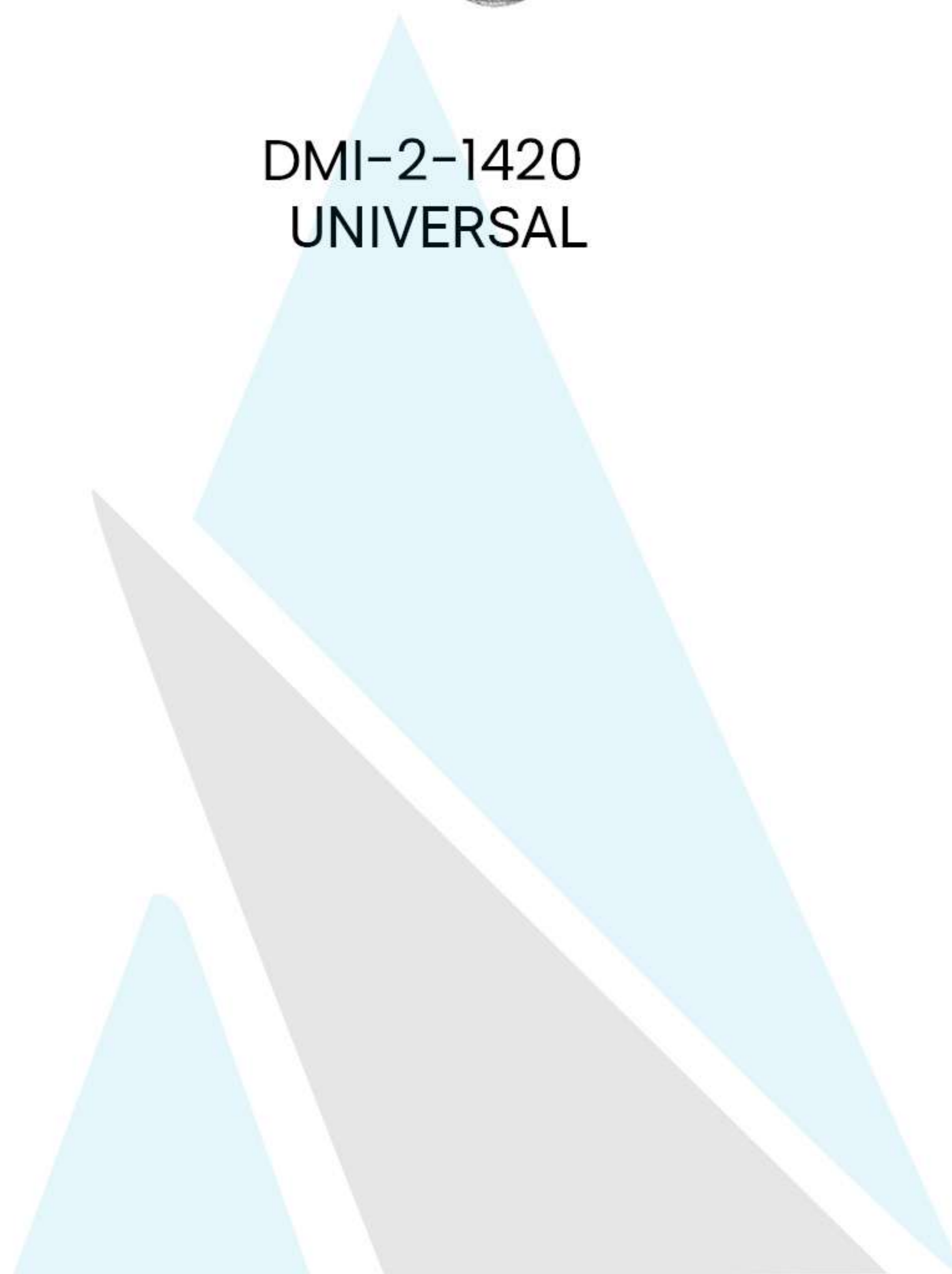

DMI -2-1422
.0015", .002"

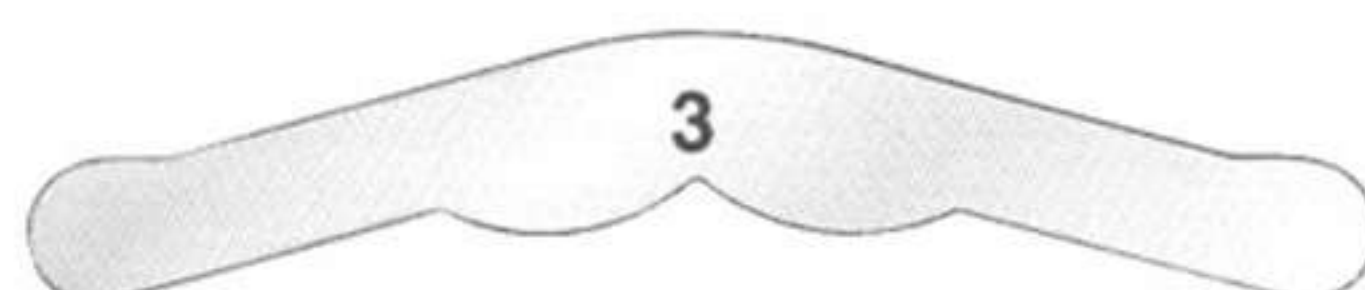

DMI-2-1423
.0015", .002"

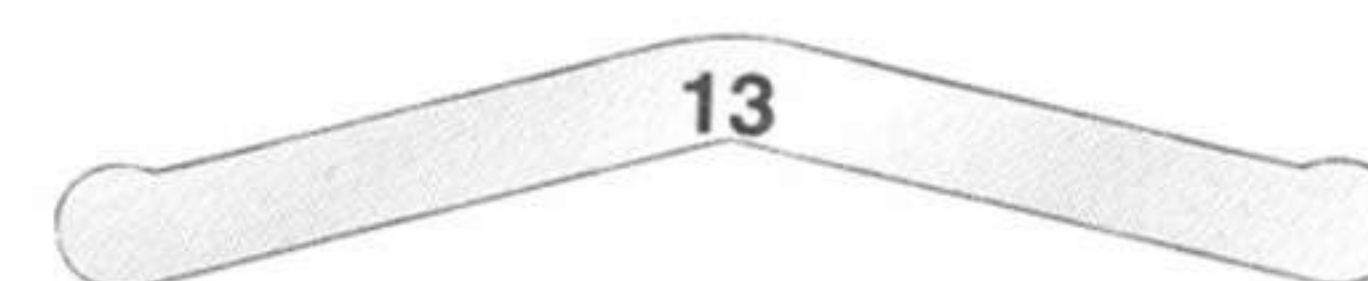

DMI-2-1424
.0015", .002"



DMI-2-1425
BALL CHAIN



DMI-2-1426
NON-CHILL Clear Plastic

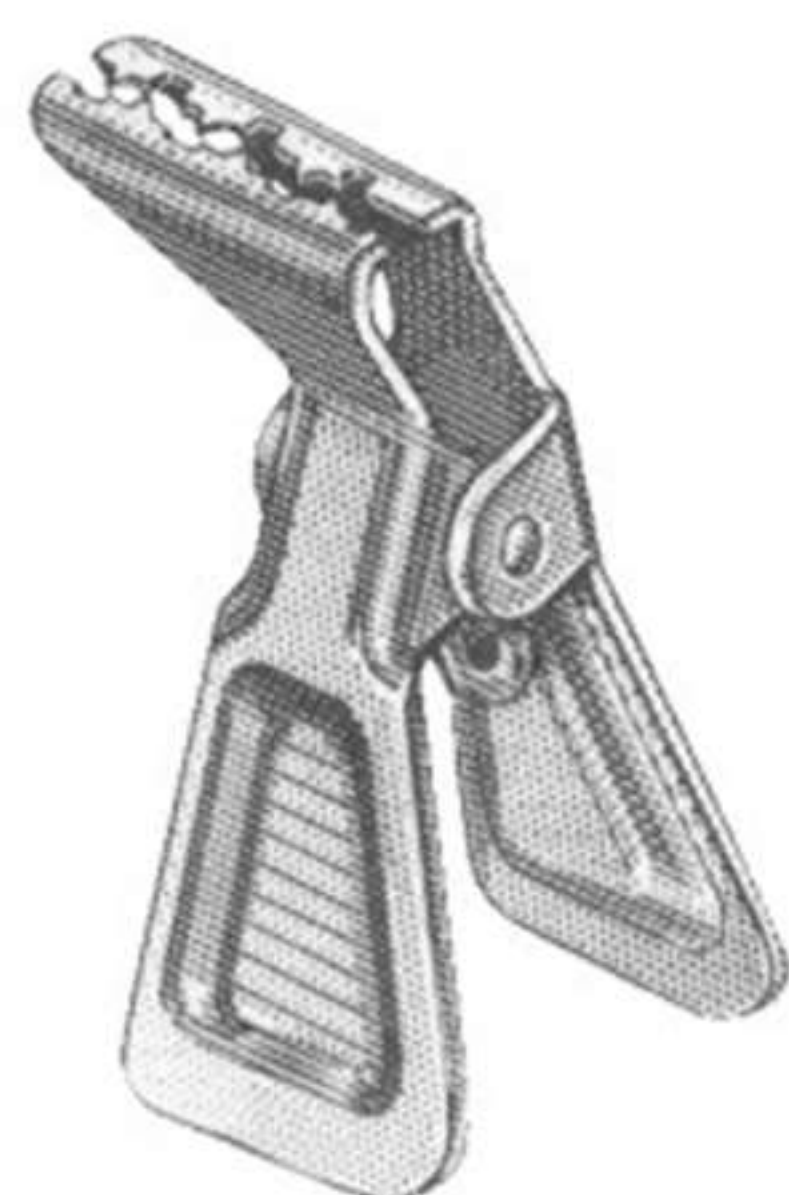

DMI-2-1427
Strip Holder Clip 90

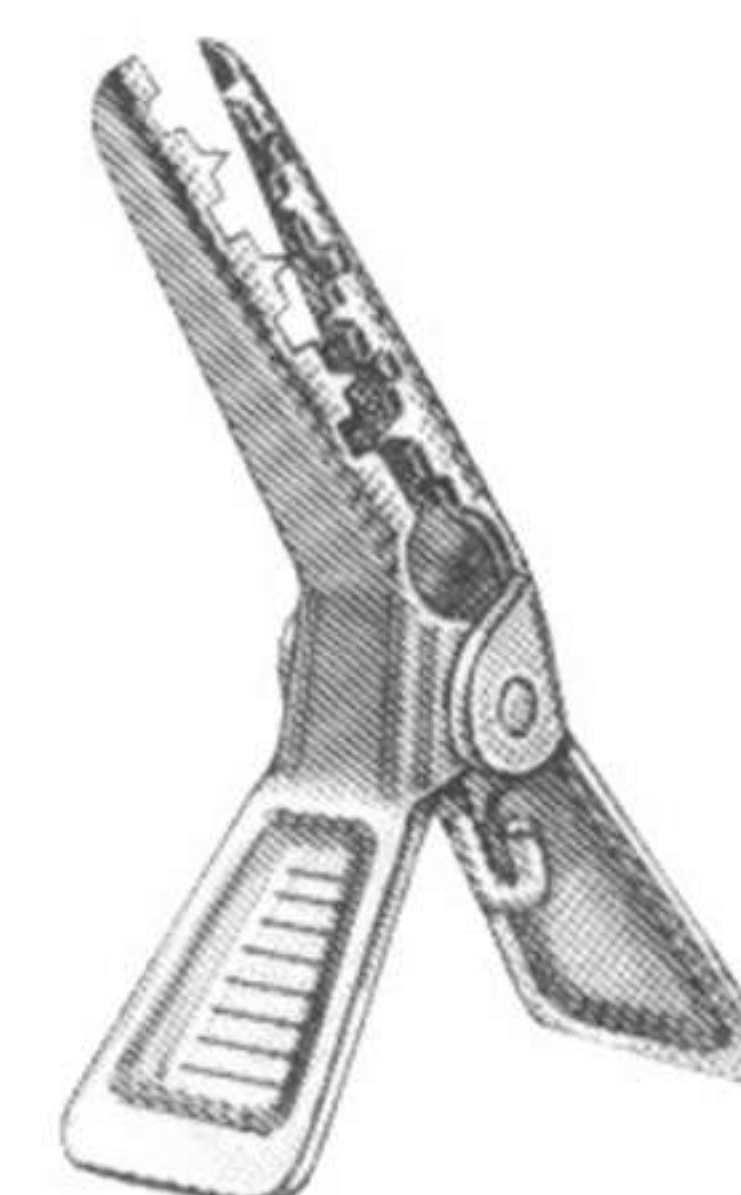

DMI-2-1428
Strip Holder Clip 45

**Rubber Dam Instruments,
Rubber Dam clamps**



DMI-2-1501
IRORY Light weight,
170 mm



DMI-2-1502
BREWER 175 mm



DMI-2-1503
BREWER 175 mm

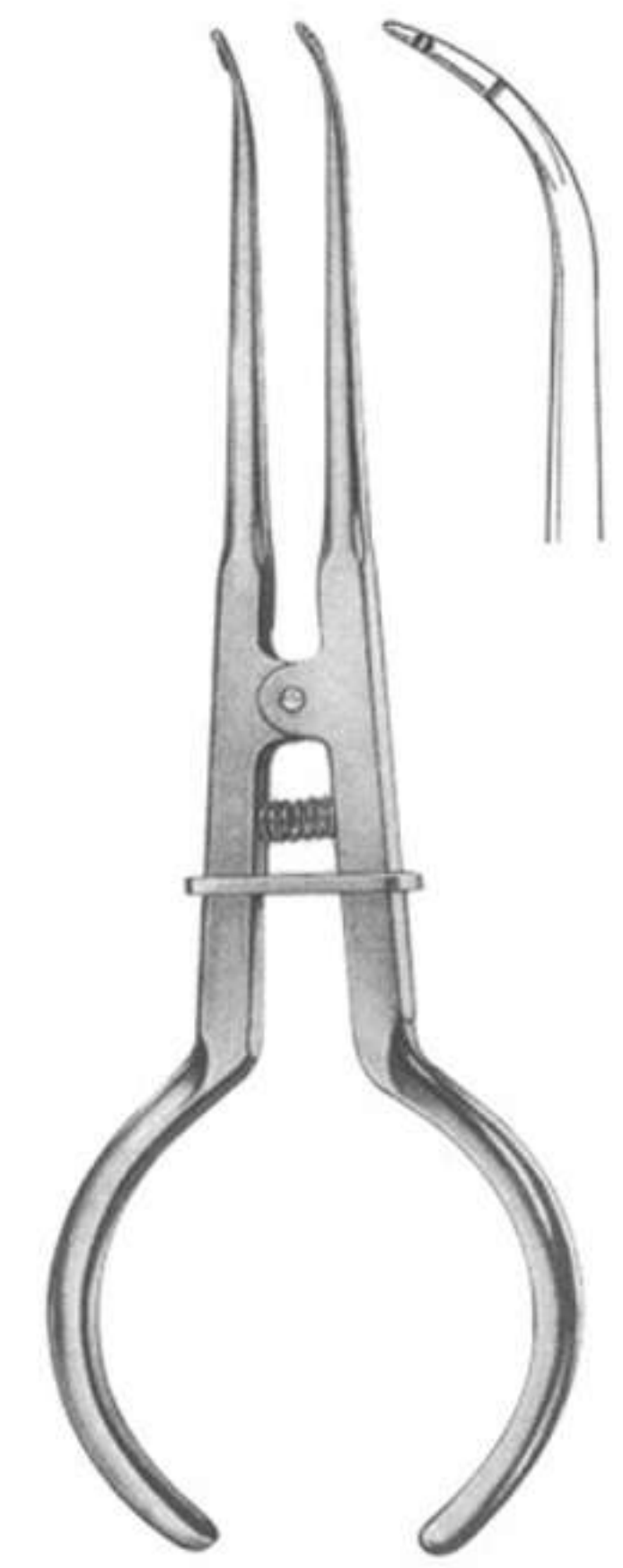

DMI-2-1504
WHITE 175 mm

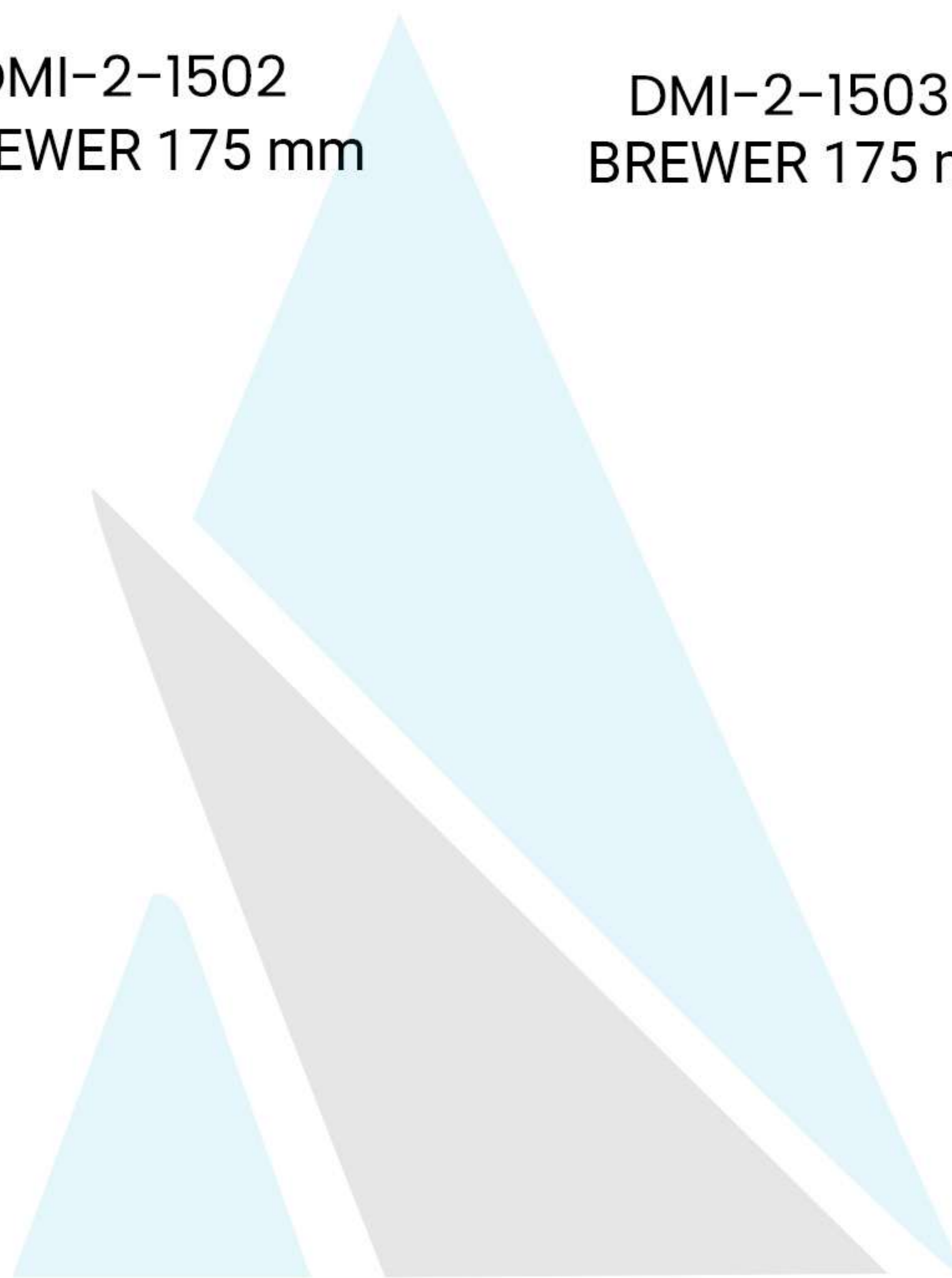

DMI-2-1505
IVORY 170 mm



DMI-2-1506
AINS WORTH Rubber
Dam Punch 170 mm



DMI-2-1507
AINS WORTH Ainsworth
Rubber Dam Punch 170 mm



DMI-2-1508
AINS WORTH Rubber
Dam Punch 170 mm

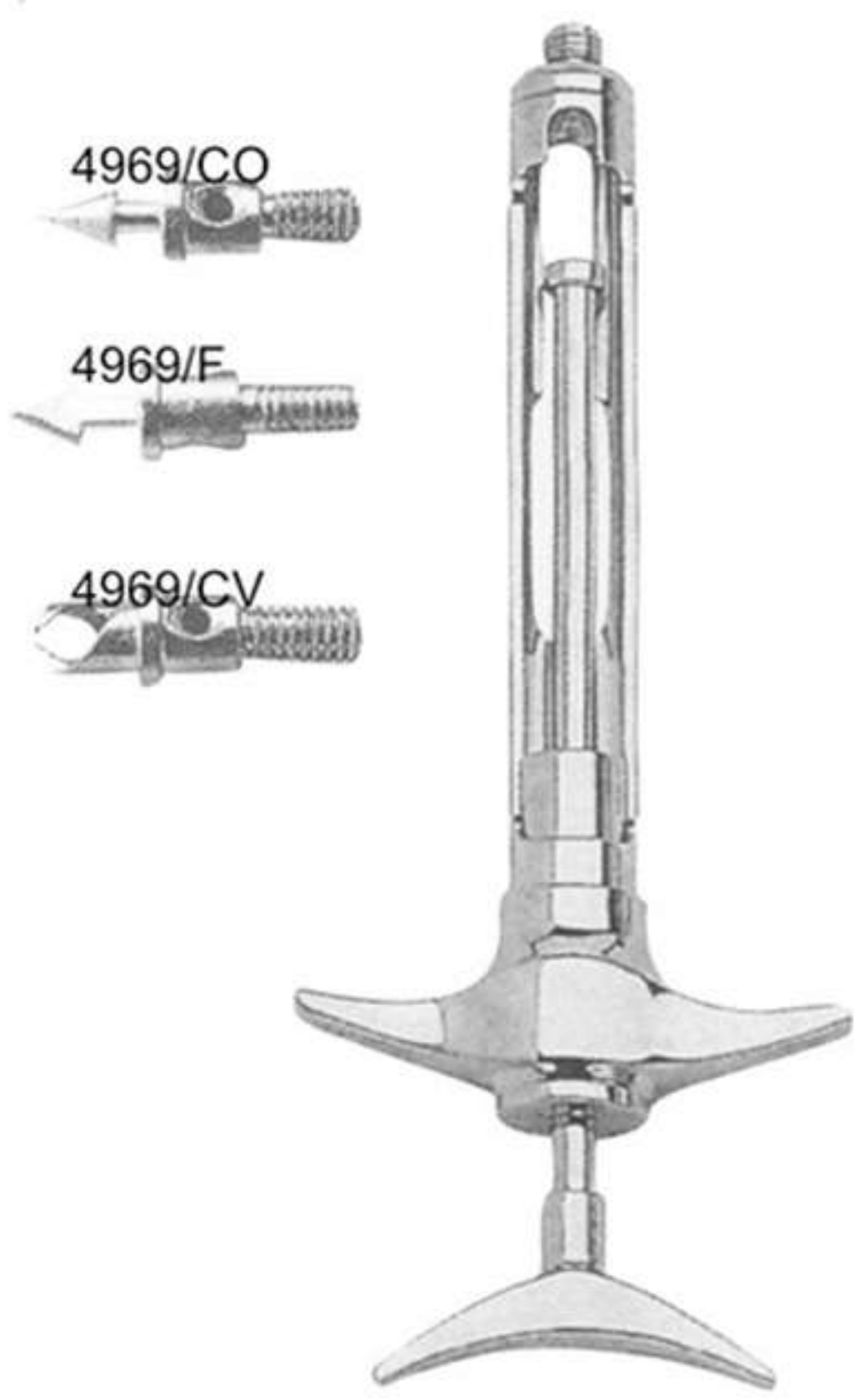

DMI-2-1601
ml 1,8 EU

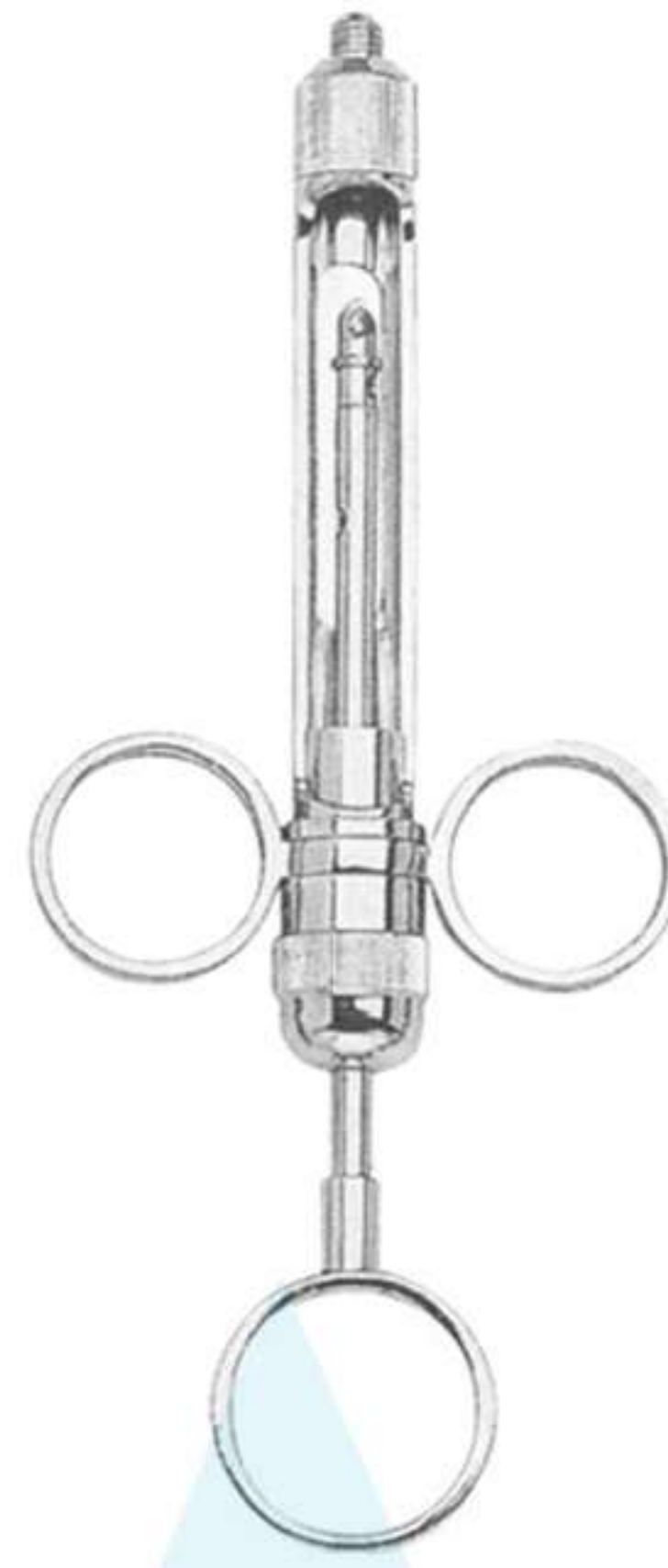

DMI-2-1602
ml 1,8 EU/AM



DMI-2-1603
ml 1,8 EU/AM



DMI-2-1604
Fig. 1 ml 1,8 EU



DMI-2-1605
Fig. 1 ml 1,8 EU

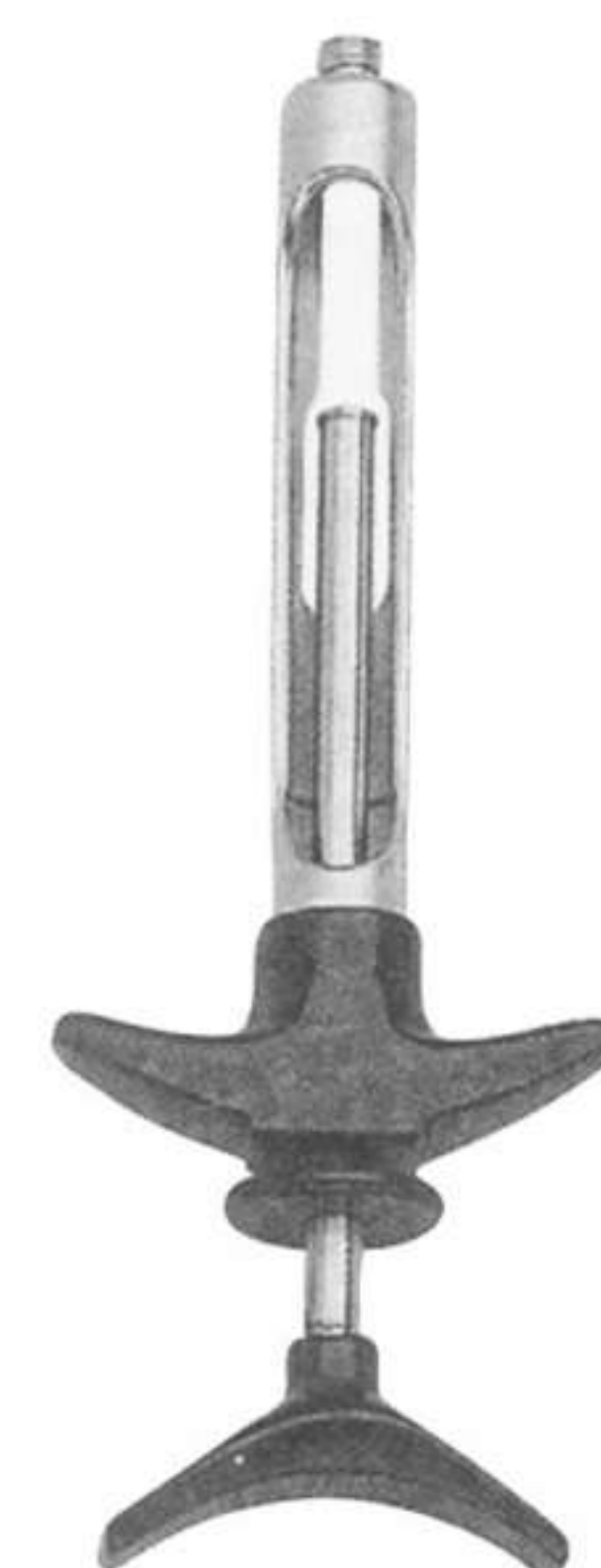

DMI-2-1606
SS INOX All inox & autoclavable
black plastic handle passive automatic
aspiration.



DMI-2-1607
Fig. 1 ml 1,8 EU/Am



DMI-2-1608
ml 1,8 EU/Am



DMI-2-1609
Fig. 1 ml 1,8 EU/Am



DMI-2-1610
ml 1,2 EU/Am

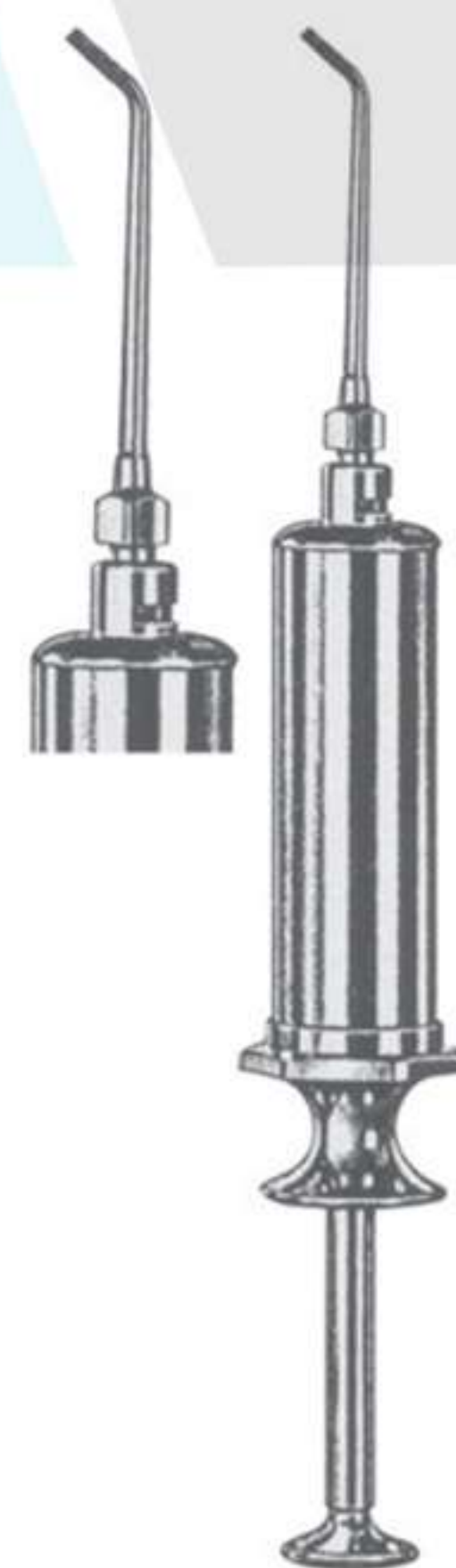

DMI-2-1611
Water Syringe complete
with 1 cannula (Lure-Lock)



DMI-2-1612
Water Syringe complete with
1 cannula (Lure-Lock)



DMI-2-1613
Metal Water Syringe
self-filling, with 1 cannula
(Luer-Lock)



DMI-2-1614
Sparrel Barrel with plunger
suitable for syringes



DMI-2-1615
Cannula, only, with
Luer-Lock connector suitable
for syringes



DMI-2-1616
Articulating Barrel
Syringe



DMI-2-1617
ml 1,8



DMI-2-1618
ml 1,8



DMI-2-1619
Fig. 1 ml 1,8



DMI-2-1620
Fig. 1 ml 1,8 EU Fig. 1 ml 1,8 EU



DMI-2-1621
Fig. 1 ml 1,8 EU

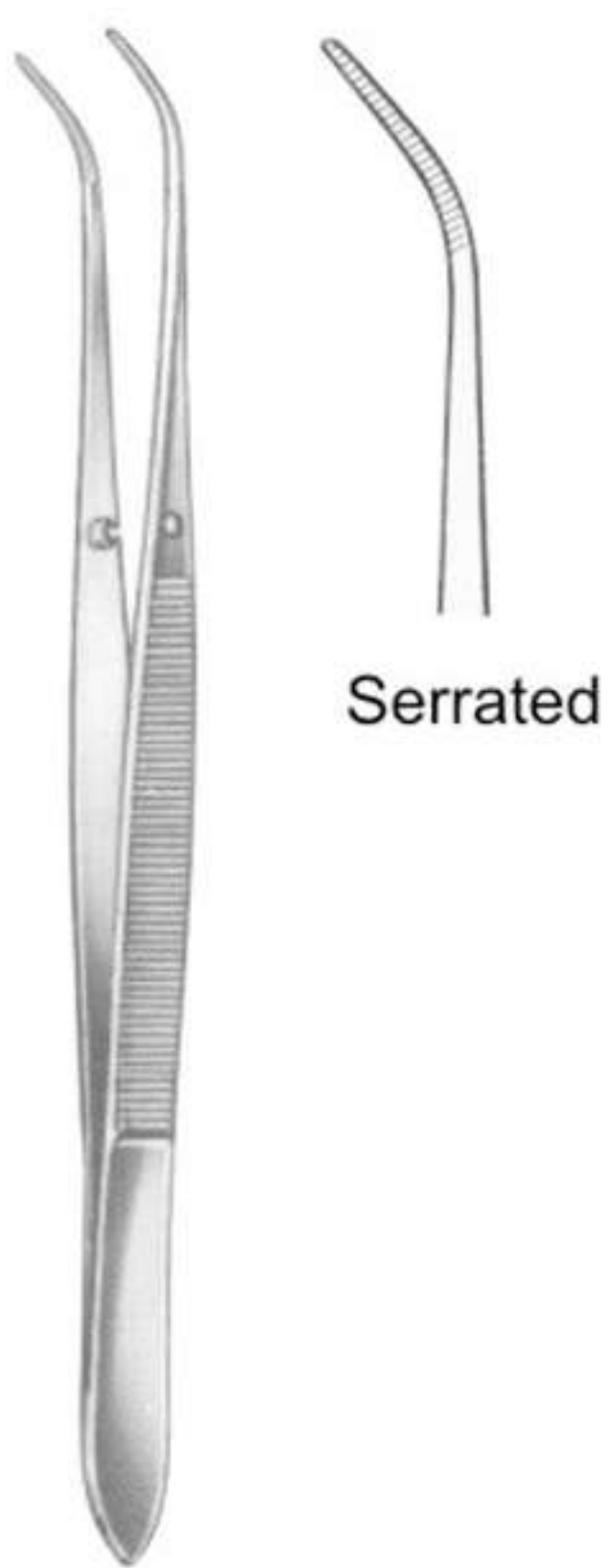

DMI-2-1622
PERRY 13 cm



DMI-2-1623
ADSON 12 cm



DMI-2-1624
MICRO ADSON 15 cm



DMI-2-1625
STANDARD 14,18,25 cm



DMI-2-1626
CUSHING 18 cm



DMI-2-1627
Curved



DMI-2-1628
SELECT 15,18,20 cm

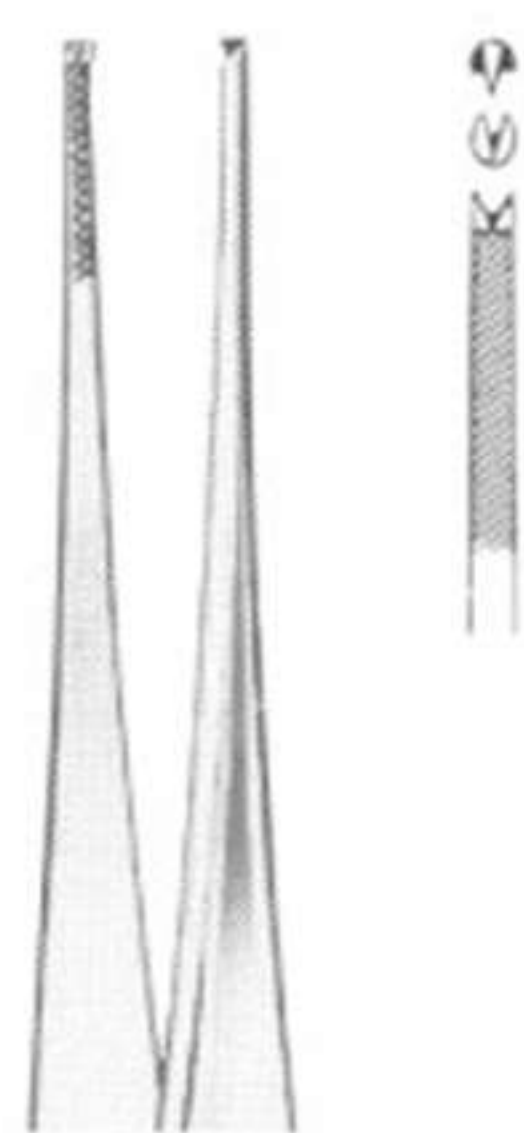

DMI-2-1629
Syringes, Tweezers, Sterilizing & Lab



DMI-2-1630
MCINDOE 15 cm



DMI-2-1631
GILLIES 15 cm

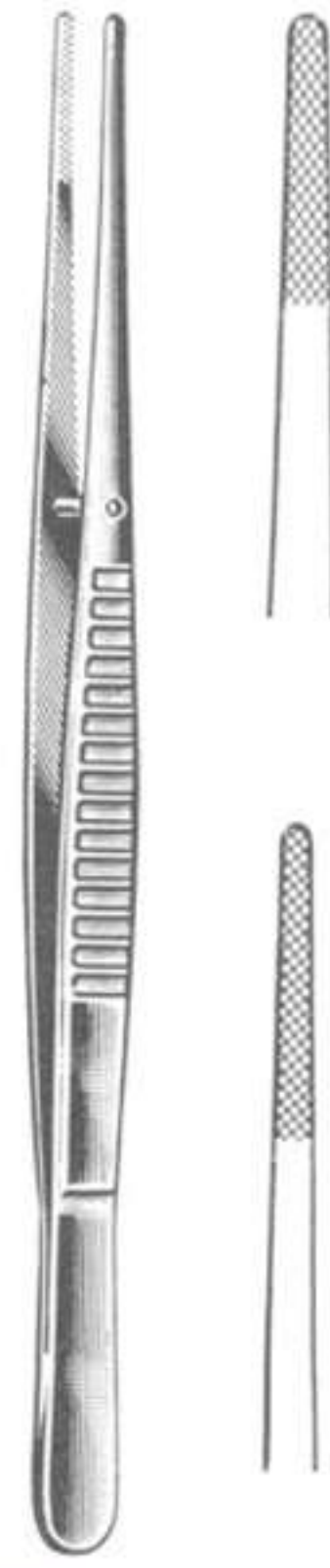

DMI-2-1632
WAUGH 15,20 cm



DMI-2-1633
KOPP 15.5 cm

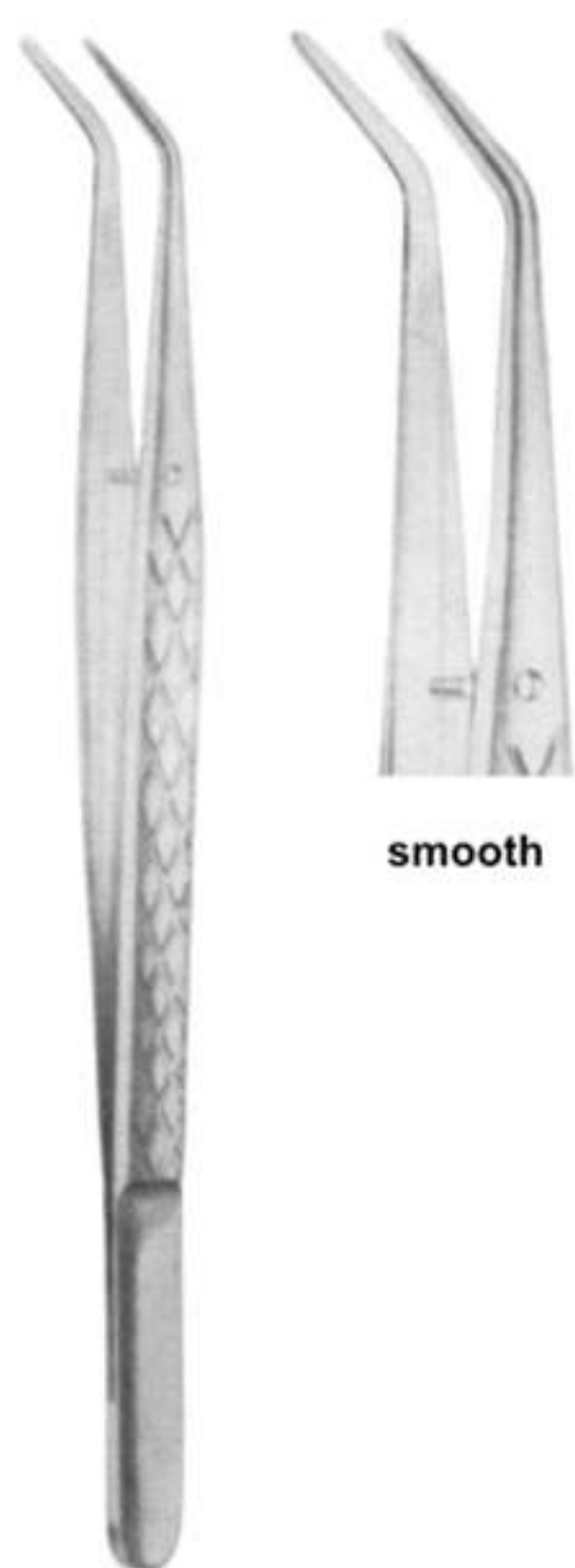

DMI-2-1634
COLLEGE 15 cm

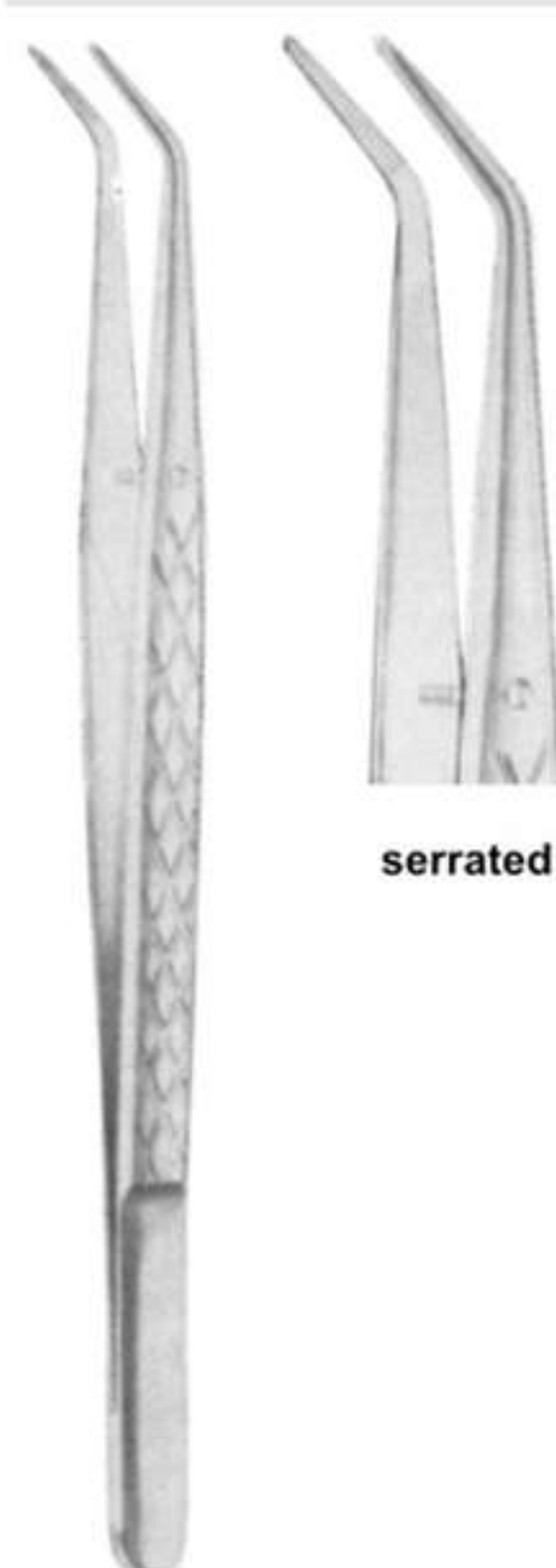

DMI-2-1635
COLLEGE 15 cm

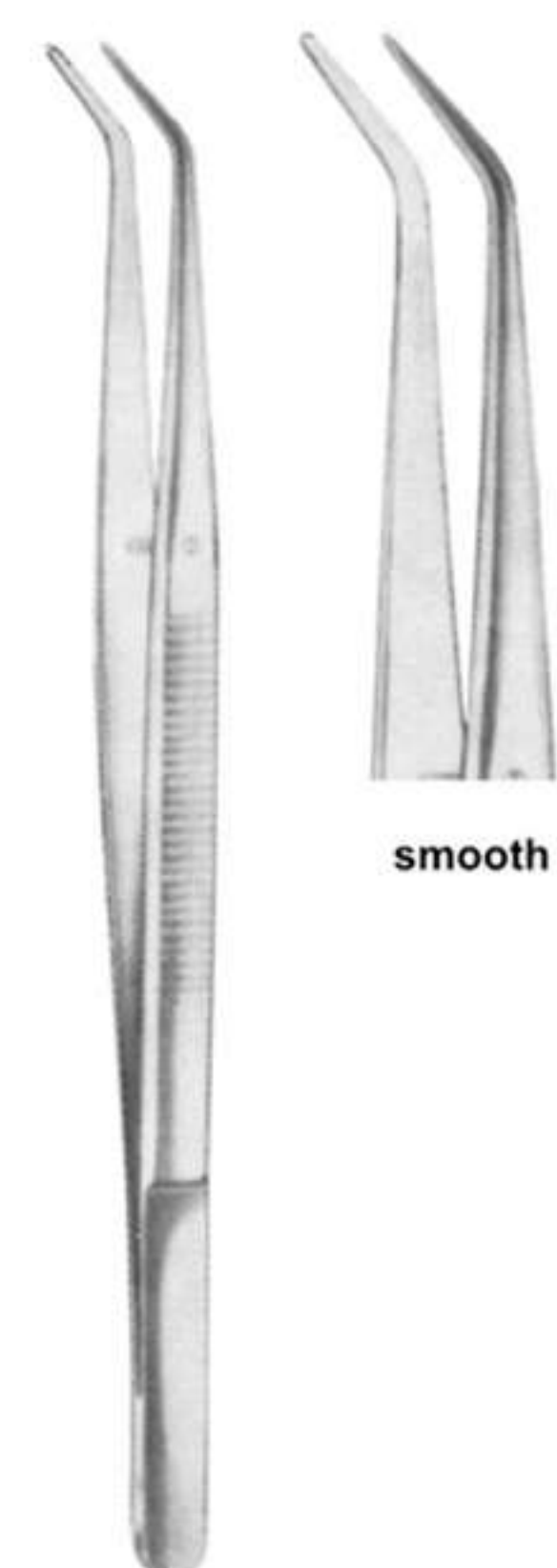

DMI-2-1636
COLLEGE

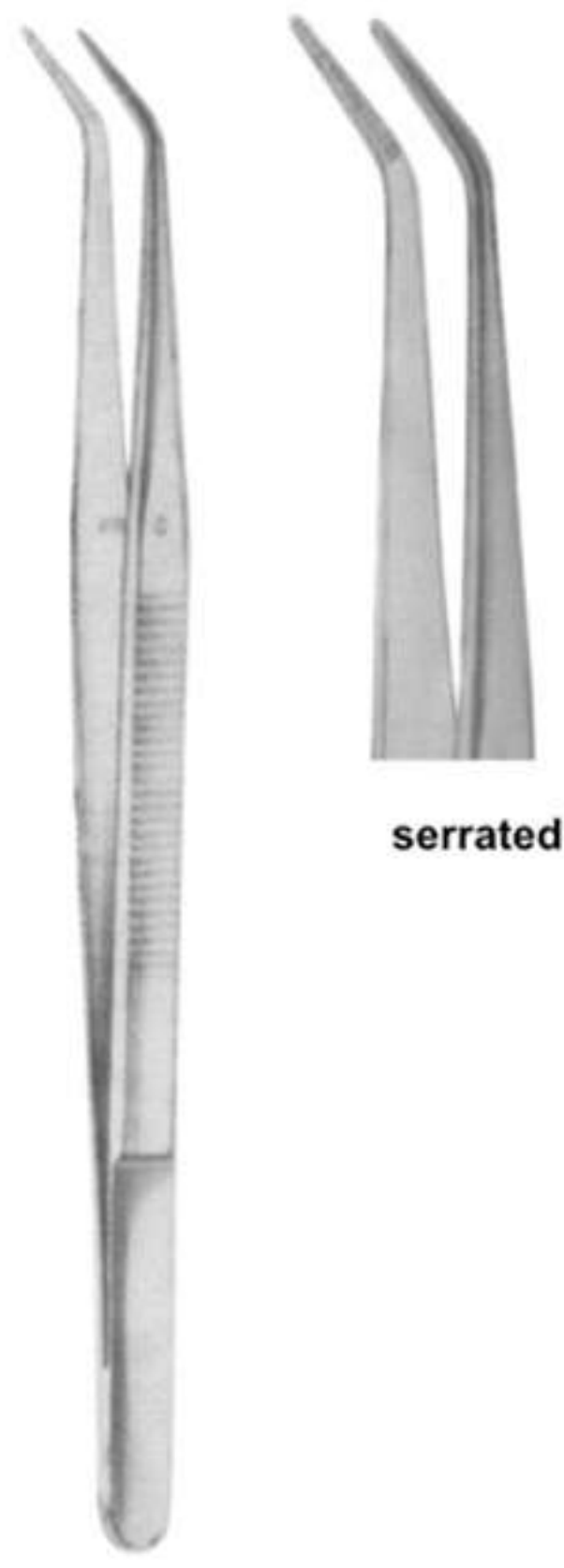

serrated

DMI-2-1637
COLLEGE 15 cm

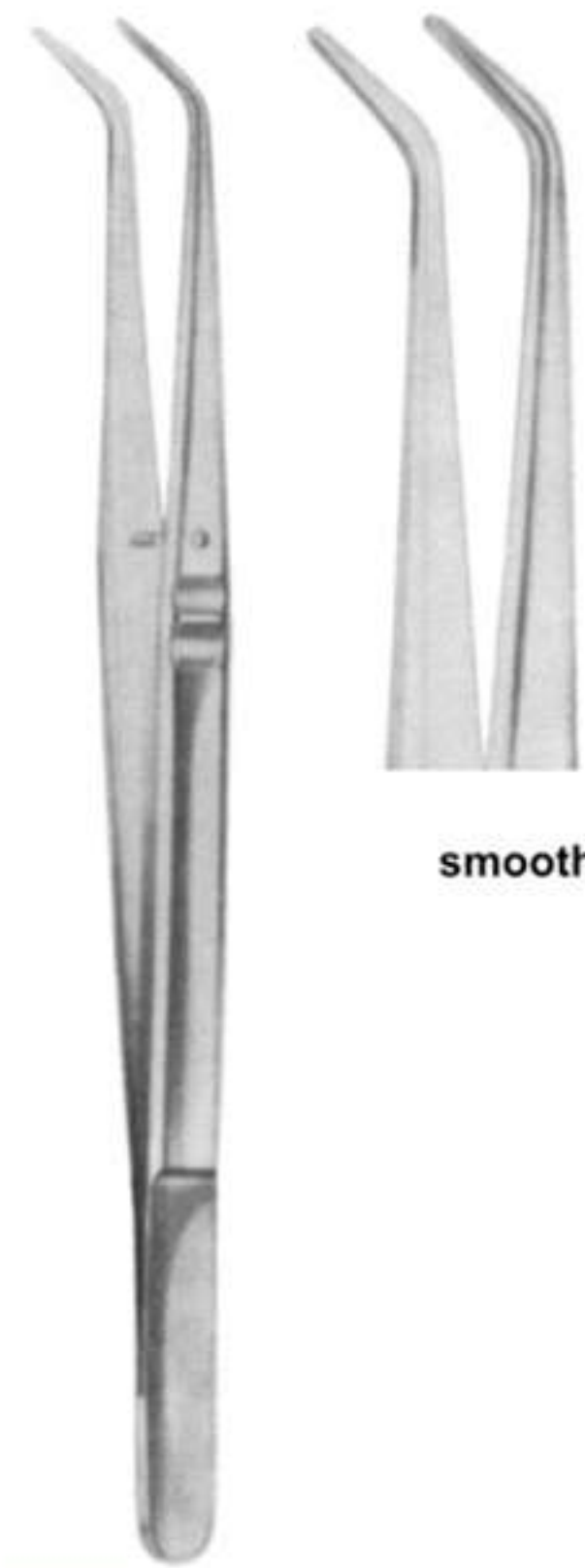

smooth

DMI-2-1638
COLLEGE 15 cm

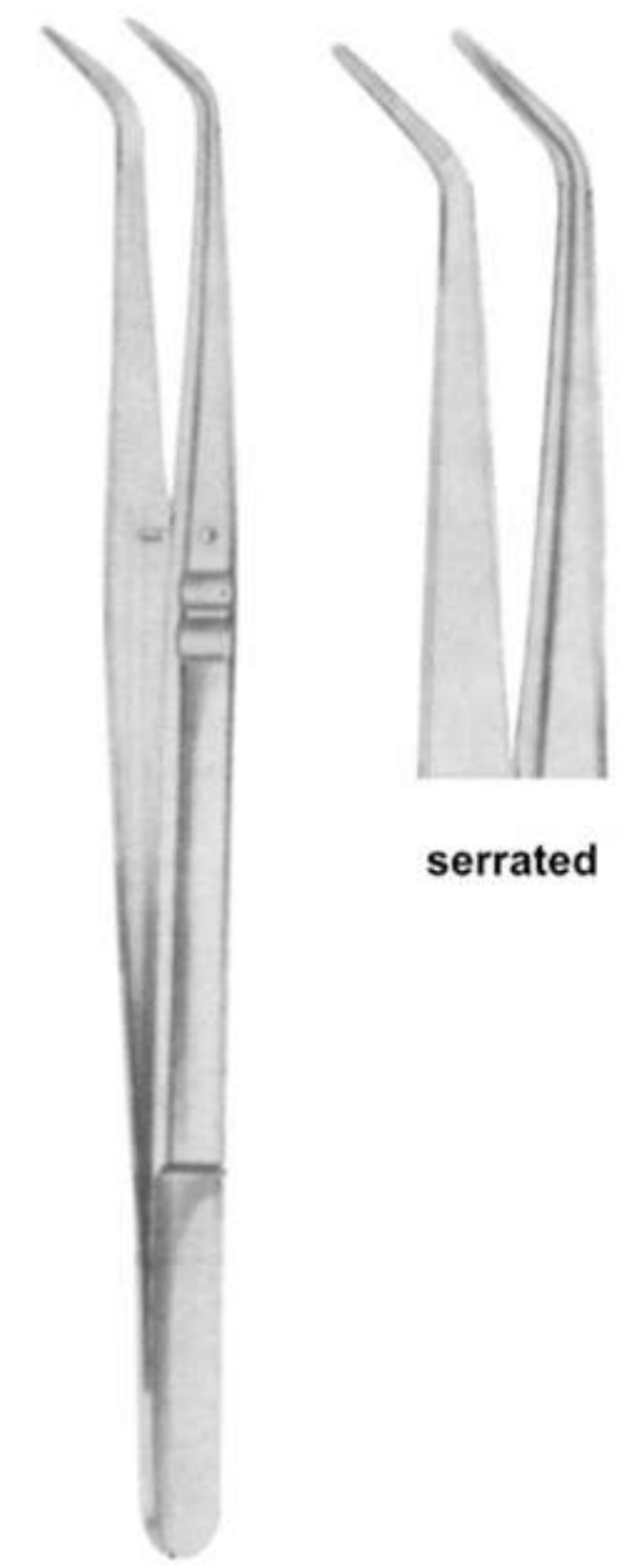

serrated

DMI-2-1639
COLLEGE 15 cm

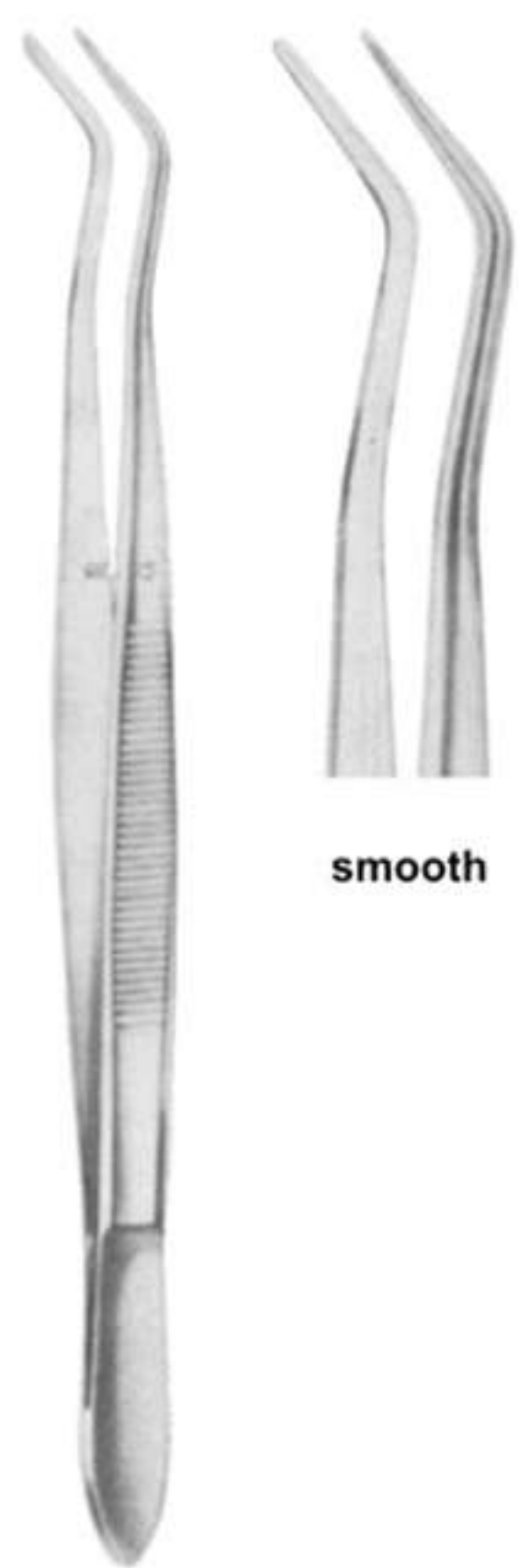
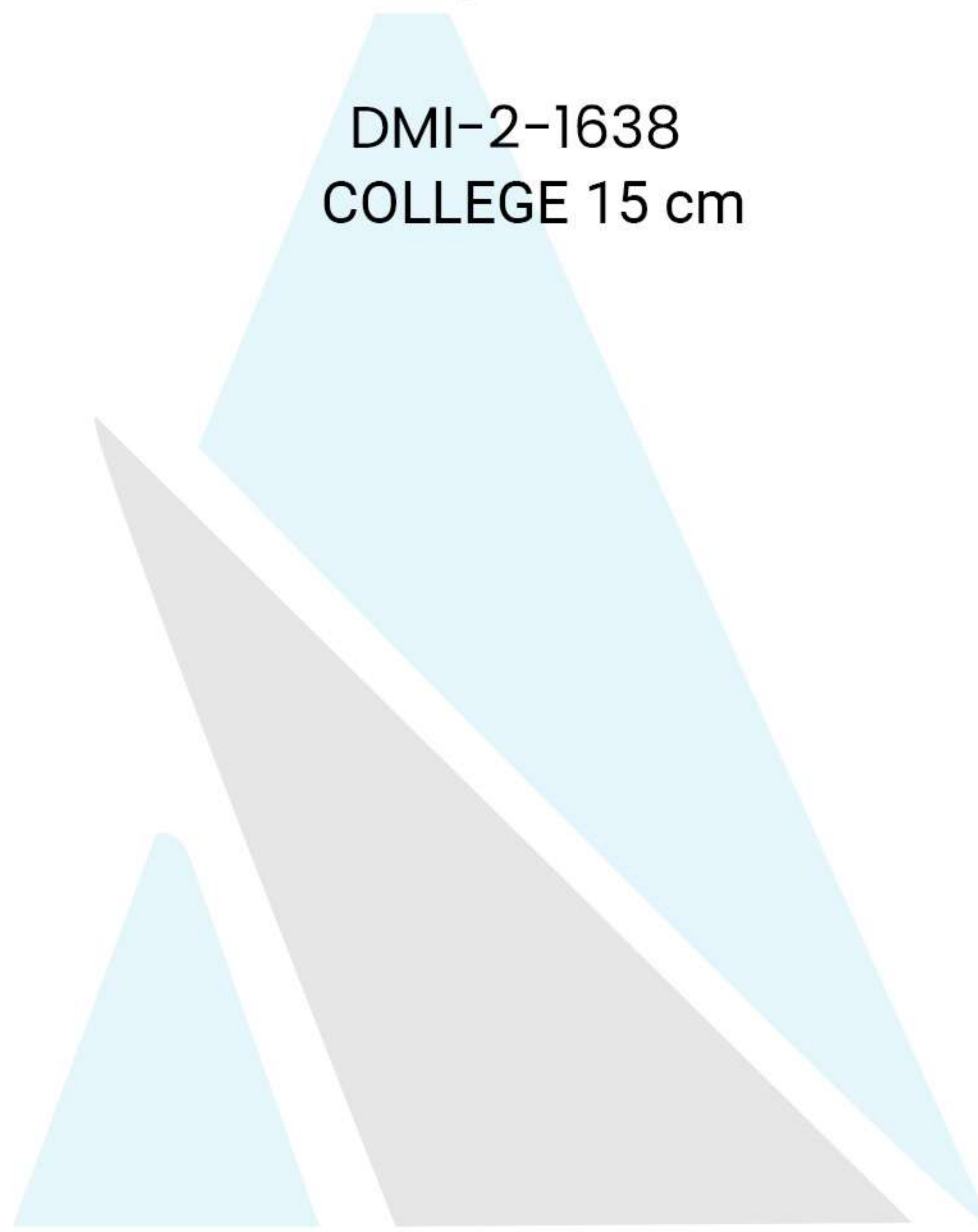

smooth

DMI-2-1640
COLLEGE 15 cm

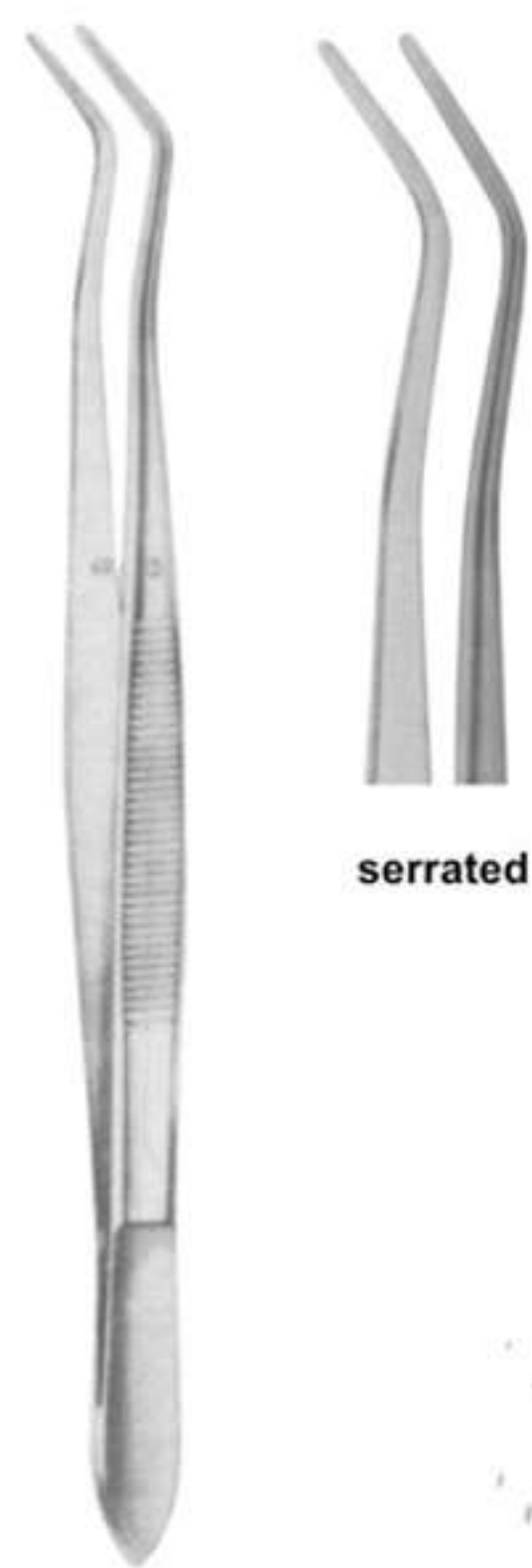

serrated

DMI-2-1641
COLLEGE 15 cm

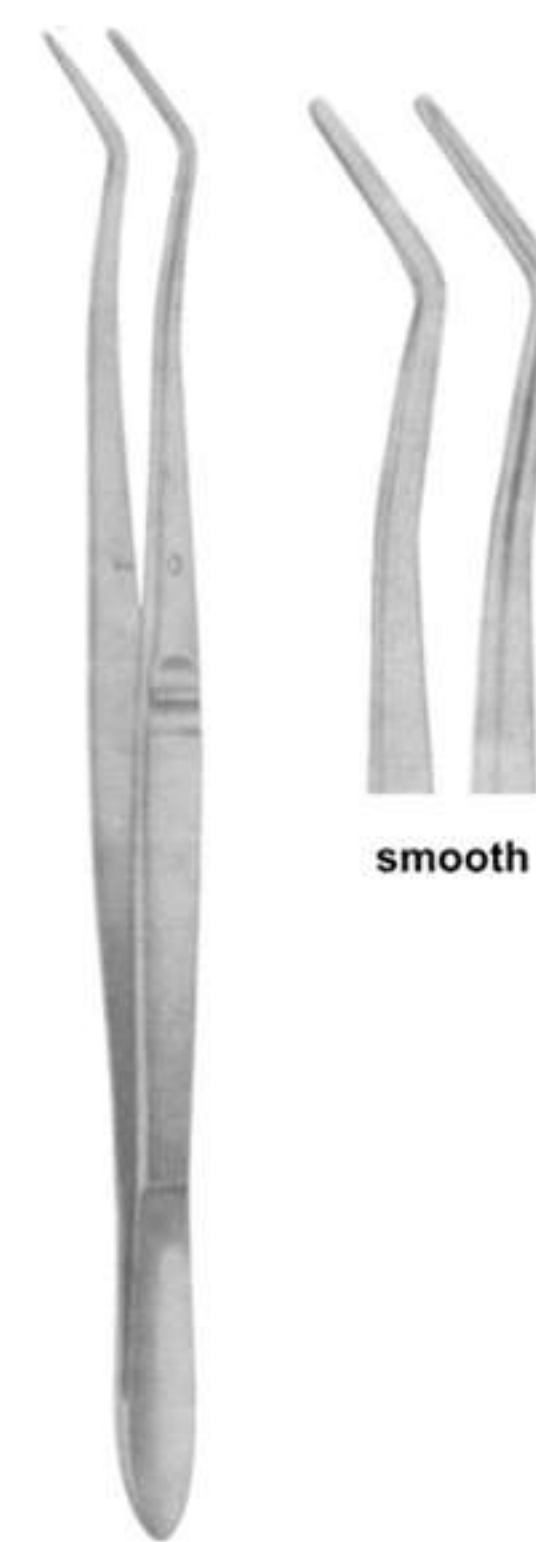

smooth

DMI-2-1642
MERIAM 16 cm

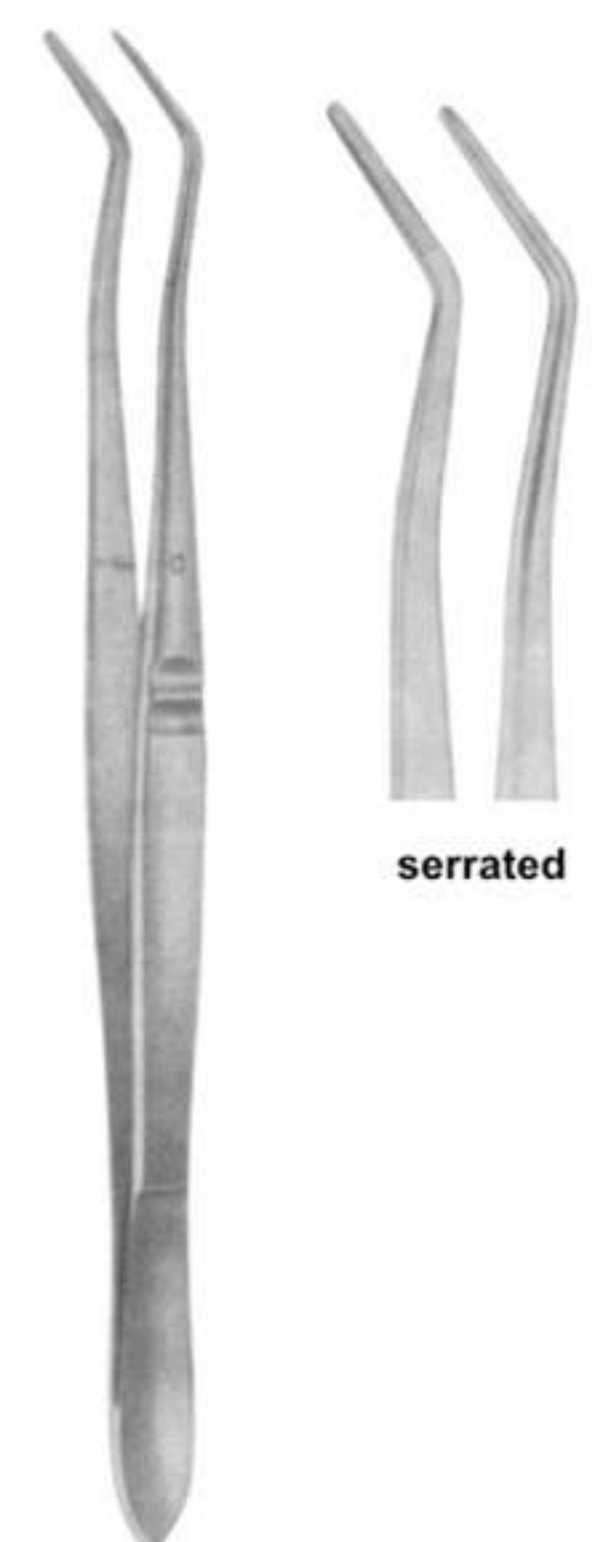

serrated

DMI-2-1643
MERIAM 16 cm

**Endodontic Forceps, Tissue Forceps,
Haemostatic Forceps, Towel Clamps**

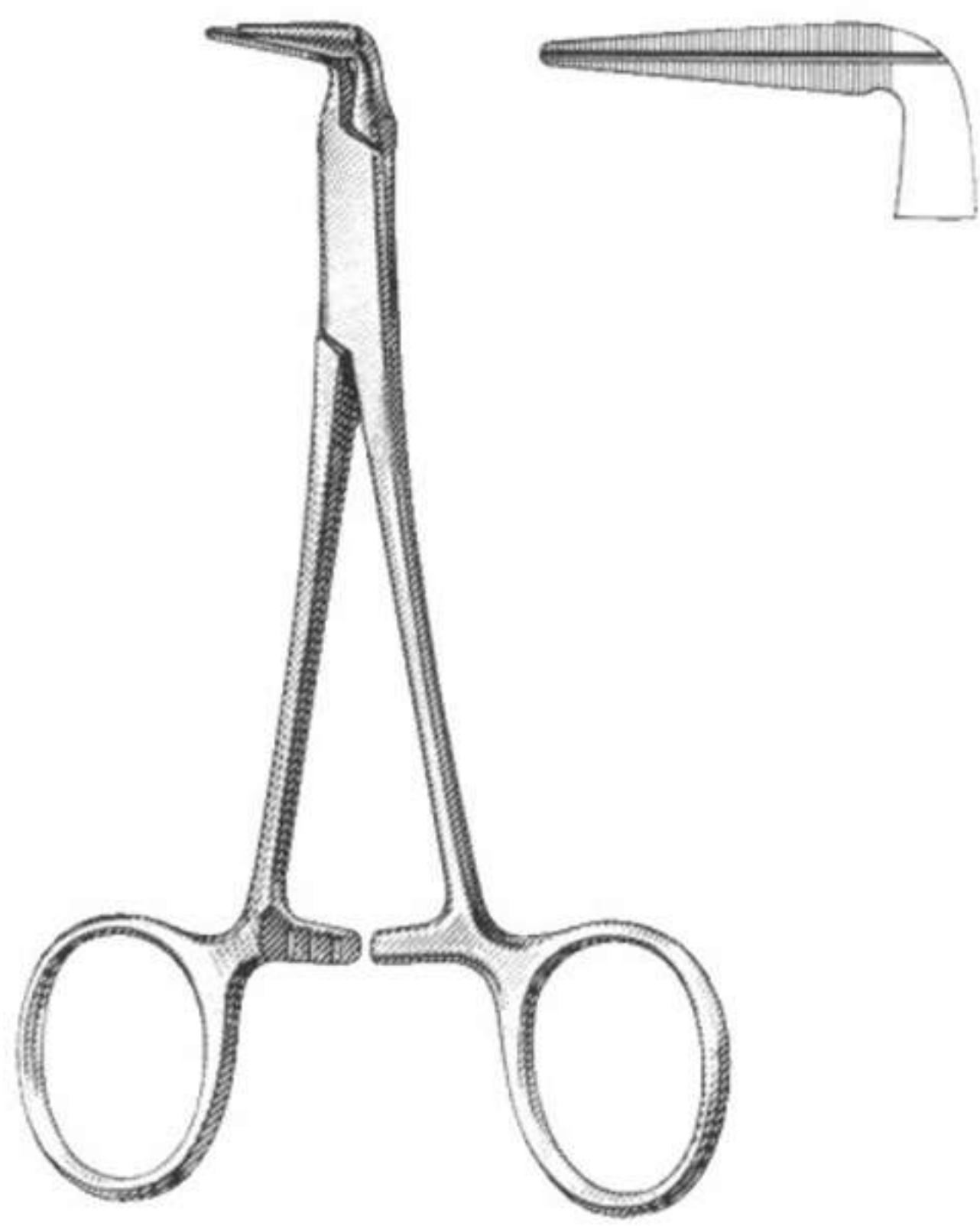

DMI-2-1701
Endo Forceps 4 3/4"

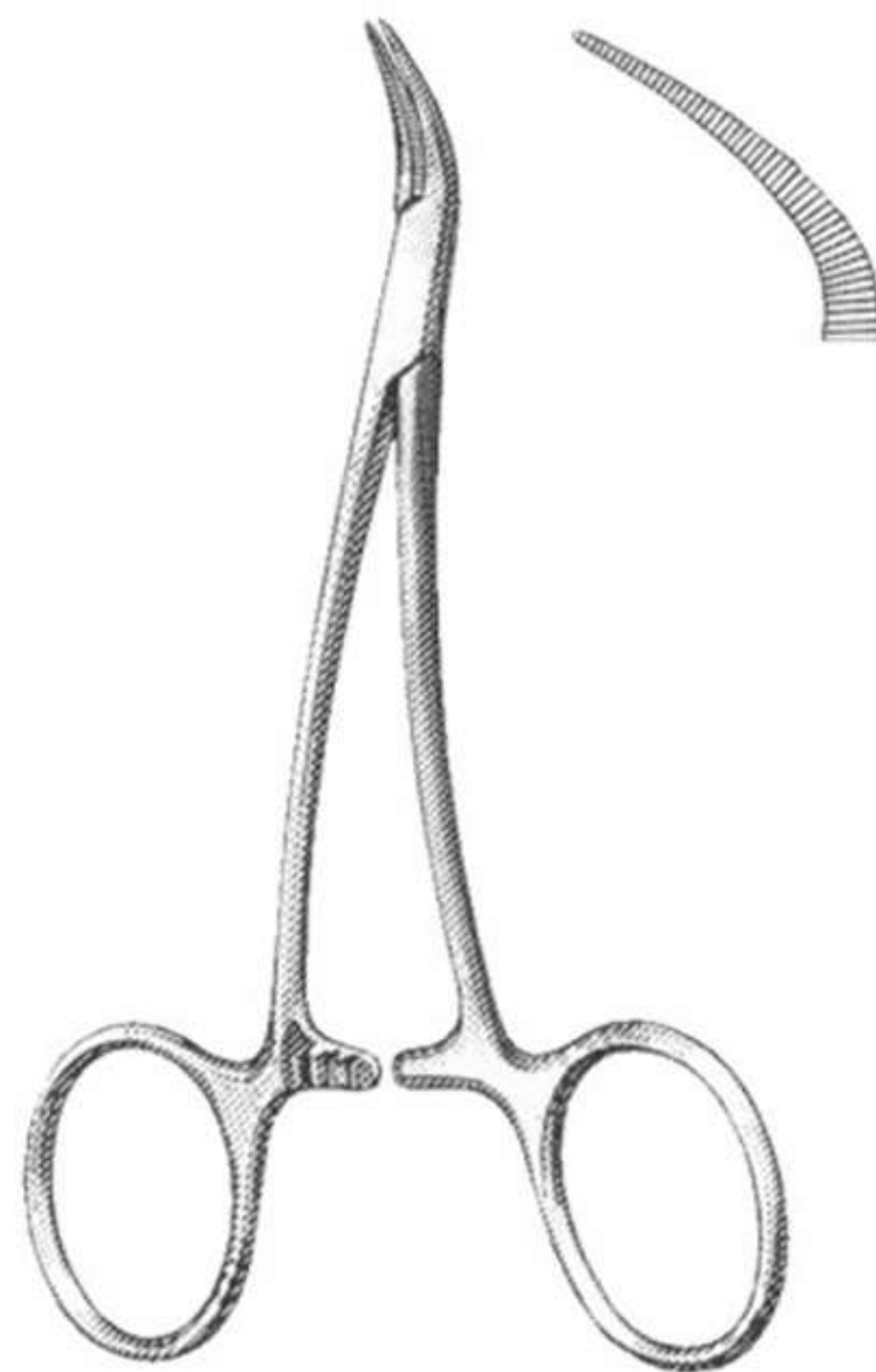

DMI-2-1702
PEETS Forceps 4 3/4",
Useful For Removing Broken Instruments

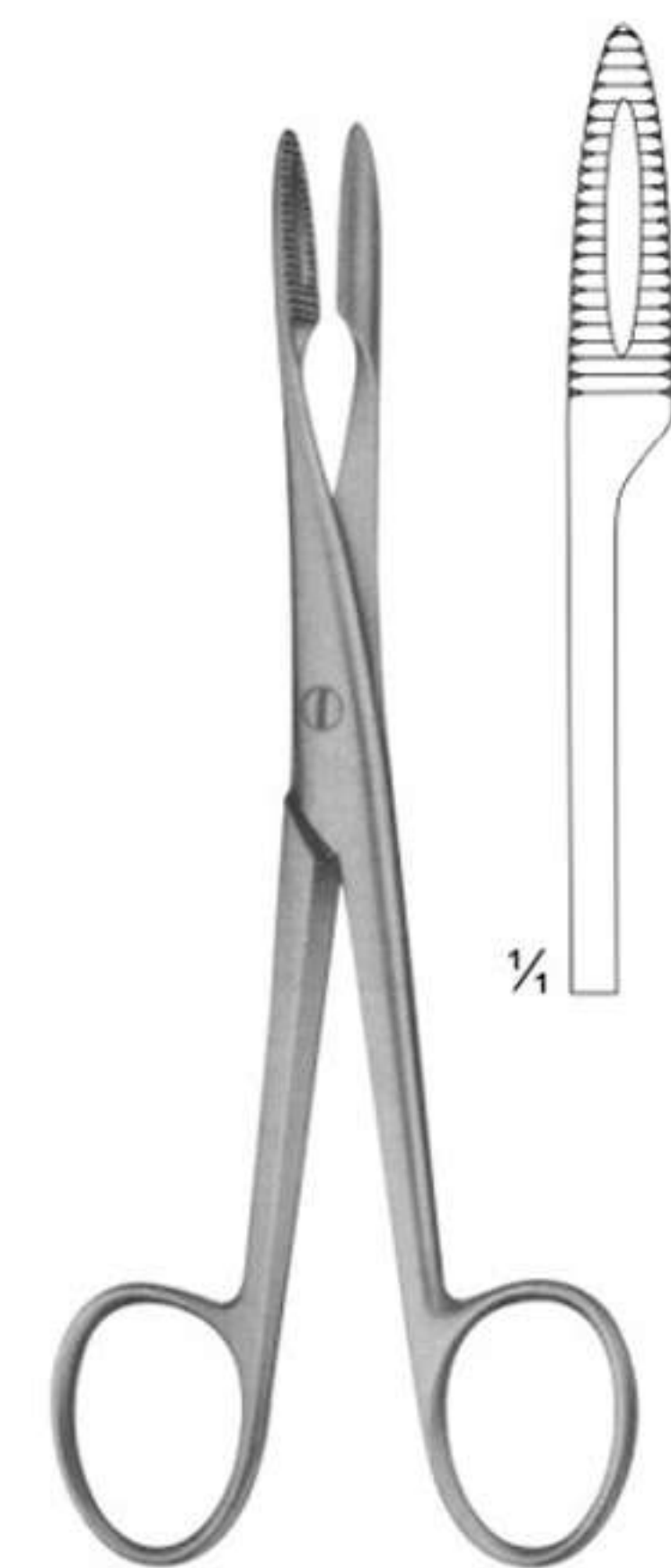

DMI-2-1703
Without Ratchet 145 mm

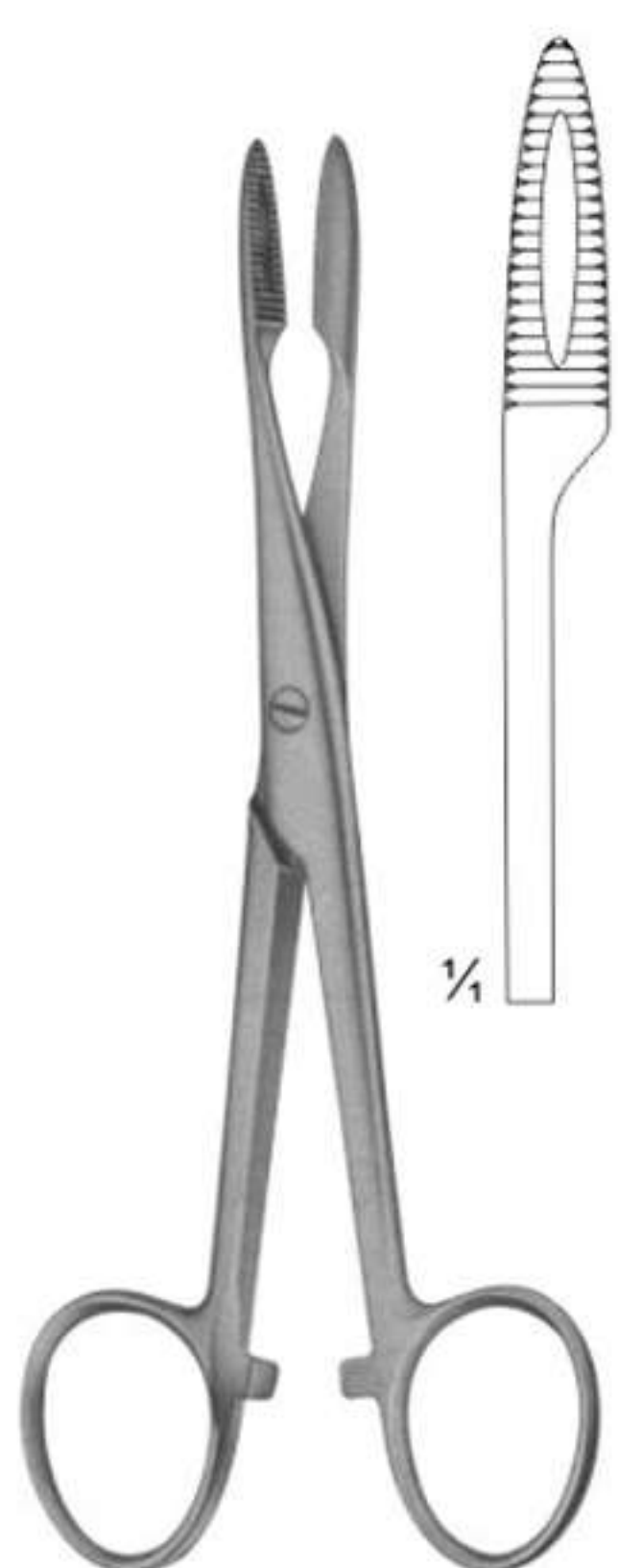

DMI-2-1704
With Ratchet 145 mm



DMI-2-1705
CRILE 140 mm



DMI-2-1706
PEAN Slender type

**Endodontic Forceps, Tissue Forceps,
Haemostatic Forceps, Towel Clamps**

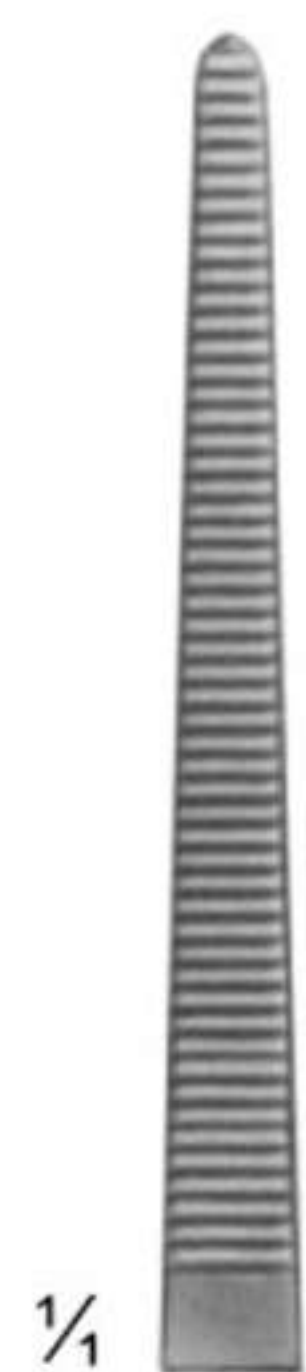

DMI-2-1707
130 mm



DMI-2-1708
140 mm

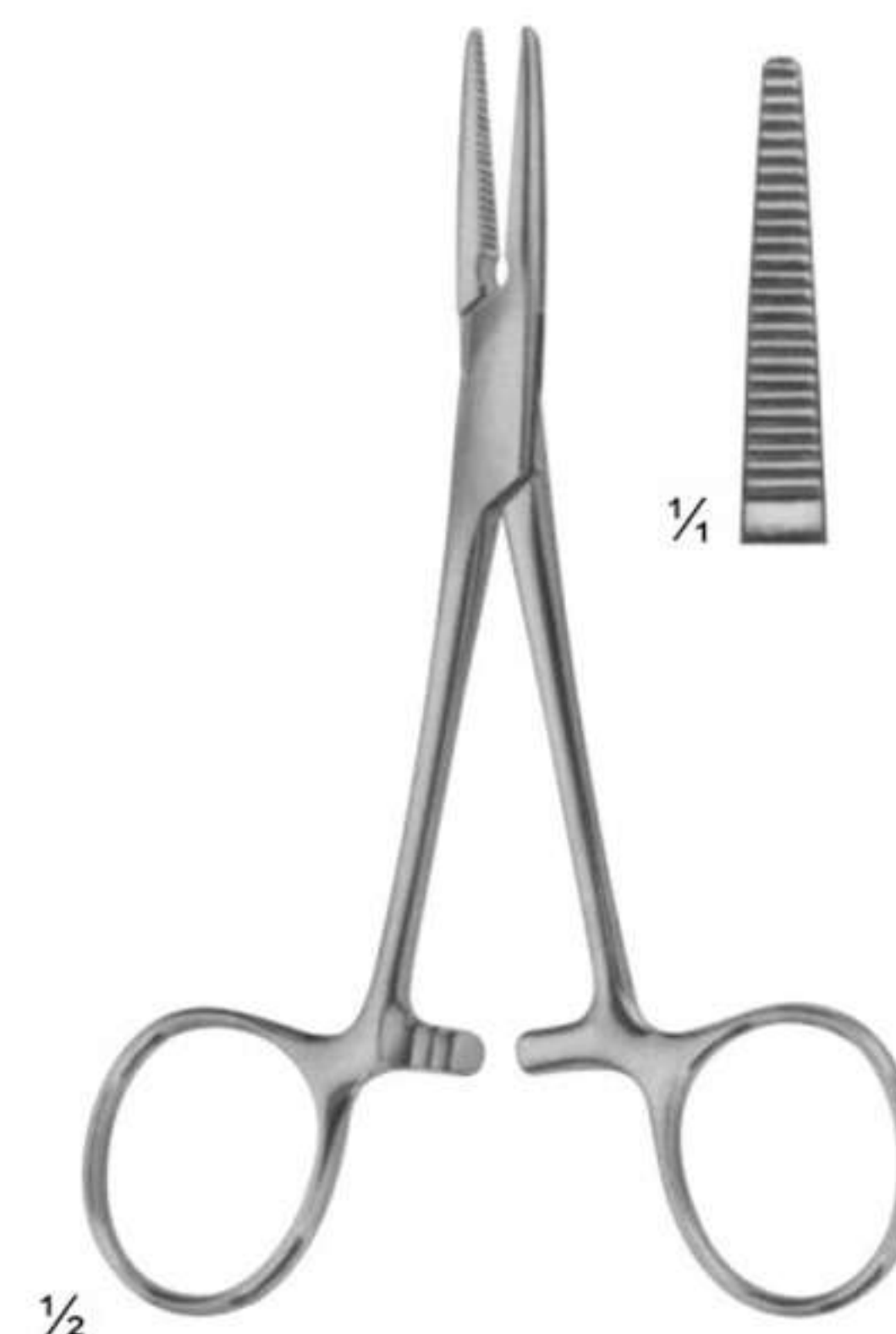

DMI-2-1709
SPENCER-WELLS



DMI-2-1710
150 mm



DMI-2-1711
130 mm



DMI-2-1712
150 mm

**Endodontic Forceps, Tissue Forceps,
Haemostatic Forceps, Towel Clamps**



DMI-2-1713
BABY-ALLIS 5",
Straight 4x5 teeth extra delicate



DMI-2-1714
ALLIS 6", Straight 4x5 teeth
extra delicate



DMI-2-1715
ALLIS 6", Straight 4x5 teeth
extra delicate



DMI-2-1716
1x2 teeth 6"



DMI-2-1717
SEMKIN 6", Straight, 1x2 teeth



DMI-2-1718
ADSON 4 3/4" 1x2 teeth

**Endodontic Forceps, Tissue Forceps,
Haemostatic Forceps, Towel Clamps**



DMI-2-1719
BROWN-ADSON 4 3/4" 7x7 teeth



DMI-2-1720
BROWN 6" 8x8 teeth



DMI-2-1721
RUSSIAN 6" 8x8 teeth



DMI-2-1722
HALSTED-MOSQUITO
Straight, Curved, 5"



DMI-2-1723
HALSTED-MOSQUITO Straight,
Curved, 5" 1x2 teeth



DMI-2-1724
HALSTED-MOSQUITO Jaws 45
Angled on Flat, 5" Extra
Delicate

**Endodontic Forceps, Tissue Forceps,
Haemostatic Forceps, Towel Clamps**



DMI-2-1725
KELLY 5 ½", Straight



DMI-2-1726
JONES 3 ½"



DMI-2-1727
BACKHAUS 3 ½"

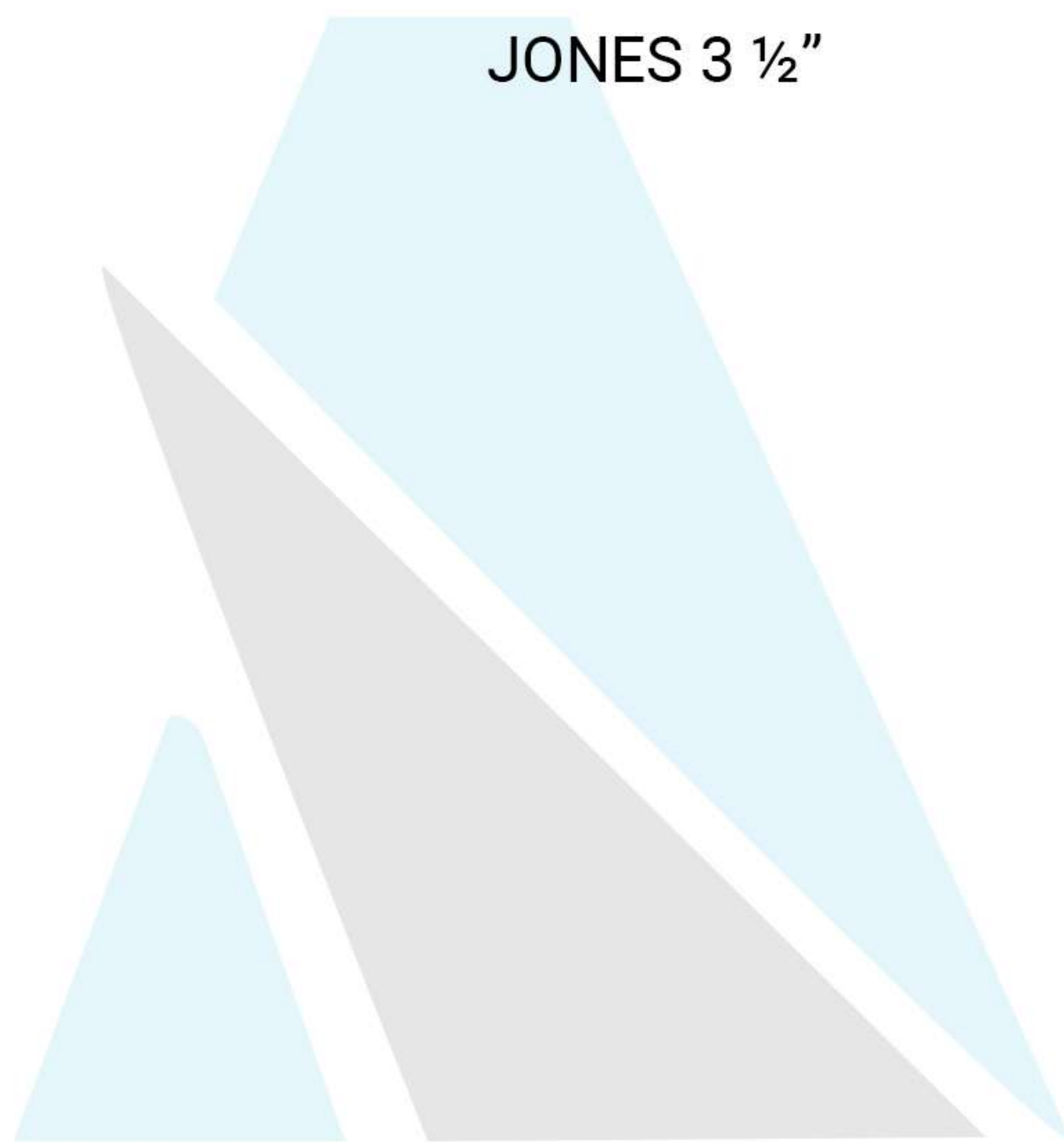

DMI-2-1728
BACKHAUS 5 ¼"



DMI-2-1729
LORNA Non Perforated 3 ½"

**Retractors, Lip & Cheek Retractor,
Hook, Depressor & Mouth Gagss**



DMI-2-1807
WEITLANER Sharp 130 mm

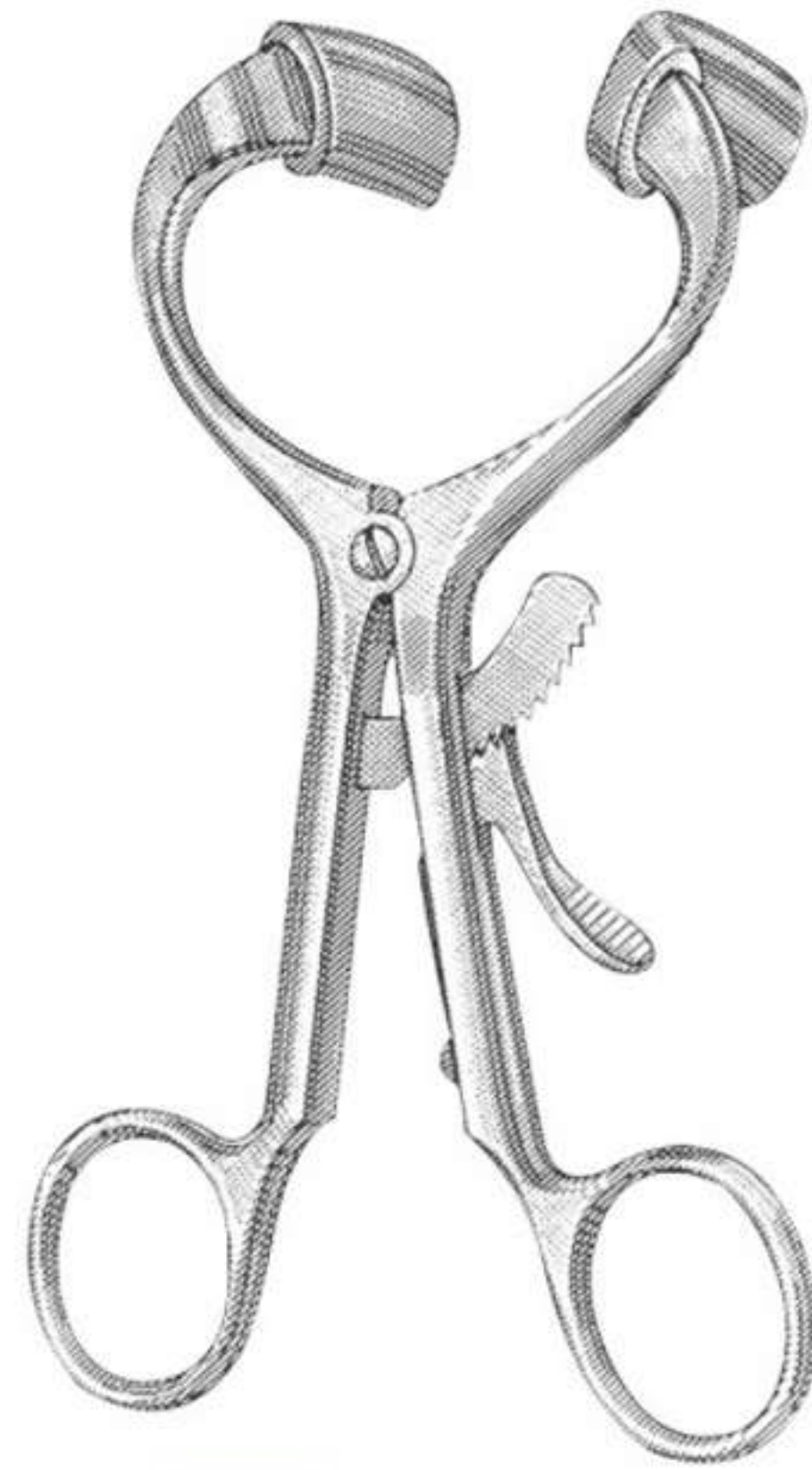

DMI-2-1808
MOLT Adult

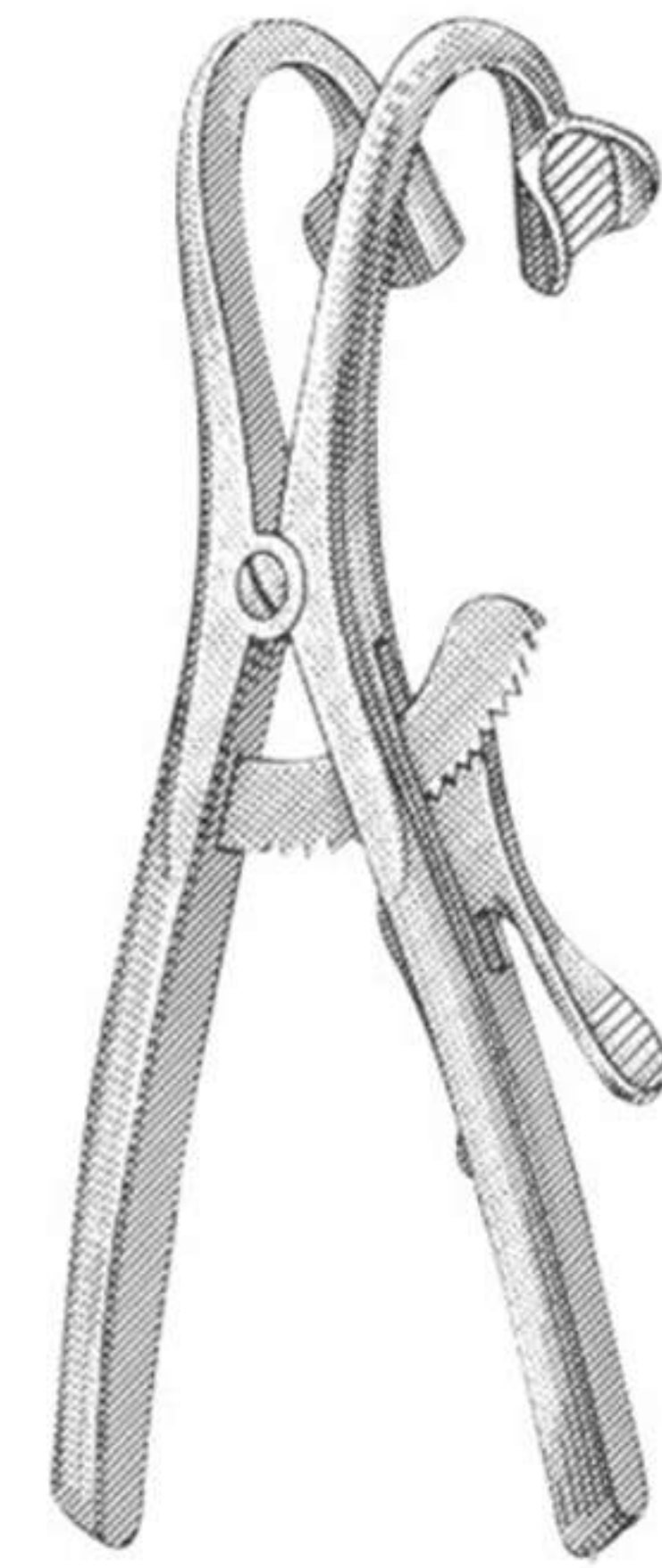

DMI-2-1809
DENHART



DMI-2-1810
140 mm

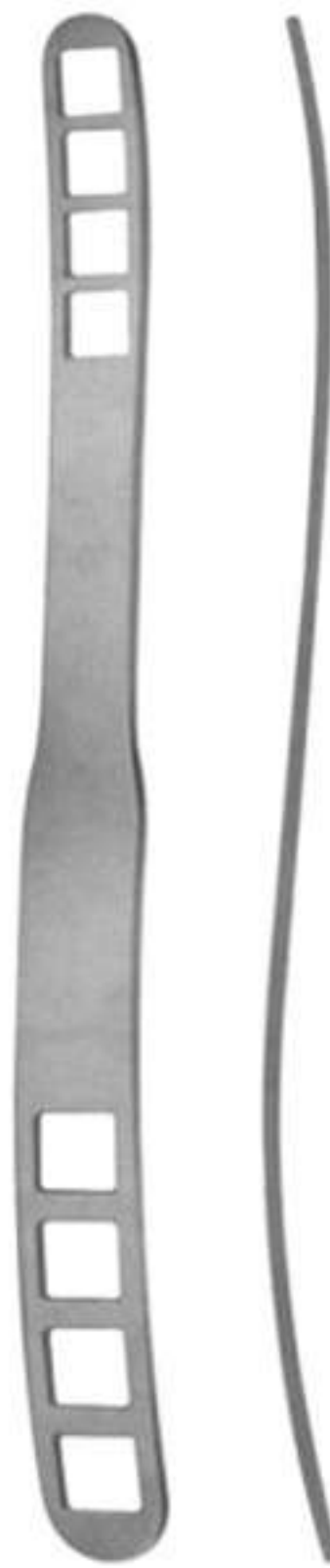

DMI-2-1811
BRUENINGS 190 mm



DMI-2-1812
Retractors, Lip & Cheek Retractor,
Hook, Depressor & Mouth Gagss

**Retractors, Lip & Cheek Retractor,
Hook, Depressor & Mouth Gagss**



DMI-2-1813
Retractors, Lip & Cheek
Retractor, Hook, Depressor
& Mouth Gagss



DMI-2-1814
Retractors, Lip & Cheek Retractor, Hook,
Depressor & Mouth Gagss



DMI-2-1815
Retractors, Lip & Cheek
Retractor, Hook, Depressor &
Mouth Gagss



DMI-2-1816
Retractors, Lip & Cheek
Retractor, Hook, Depressor &
Mouth Gagss



DMI-2-1817
Retractors, Lip & Cheek
Retractor, Hook, Depressor &
Mouth Gagss



DMI-2-1818
Retractors, Lip & Cheek
Retractor, Hook, Depressor &
Mouth Gagss

**Retractors, Lip & Cheek Retractor,
Hook, Depressor & Mouth Gags**



DMI-2-1819
LANGENBECK 210 mm



DMI-2-1820
KOCHER-LANGENBECK 215 mm



DMI-2-1821
BUCHS



DMI-2-1822
KOCHER 230 mm



DMI-2-1823
15 x 15 mm 220 mm



DMI-2-1824
22 mm 215 mm 22 mm 215 mm

**Retractors, Lip & Cheek Retractor,
Hook Depressor & Mouth Gags**



DMI-2-1825
MIDDELDORPF



DMI-2-1826
28 x 28 mm 235 mm



DMI-2-1827
KOCHER 230 mm



DMI-2-1828
COLLIN 150 mm



DMI-2-1829
ROUX Set 165 mm



DMI-2-1830
3 sharp prongs

**Retractors, Lip & Cheek Retractor,
Hook, Depressor & Mouth Gags**



DMI-2-1831
2 sharp prongs 6"



DMI-2-1832
2 sharp prongs 6"



DMI-2-1833
FOMON 145 mm



DMI-2-1834
ALM 70 mm



DMI-2-1835
SENN 3 sharp prongs 6 3/8"



DMI-2-1836
TOENNIS Dura Retractor 150mm

**Retractors, Lip & Cheek Retractor,
Hook, Depressor & Mouth Gags**



DMI-2-1837
JOSEPH 165 mm



DMI-2-1838
GILLIES 180 mm

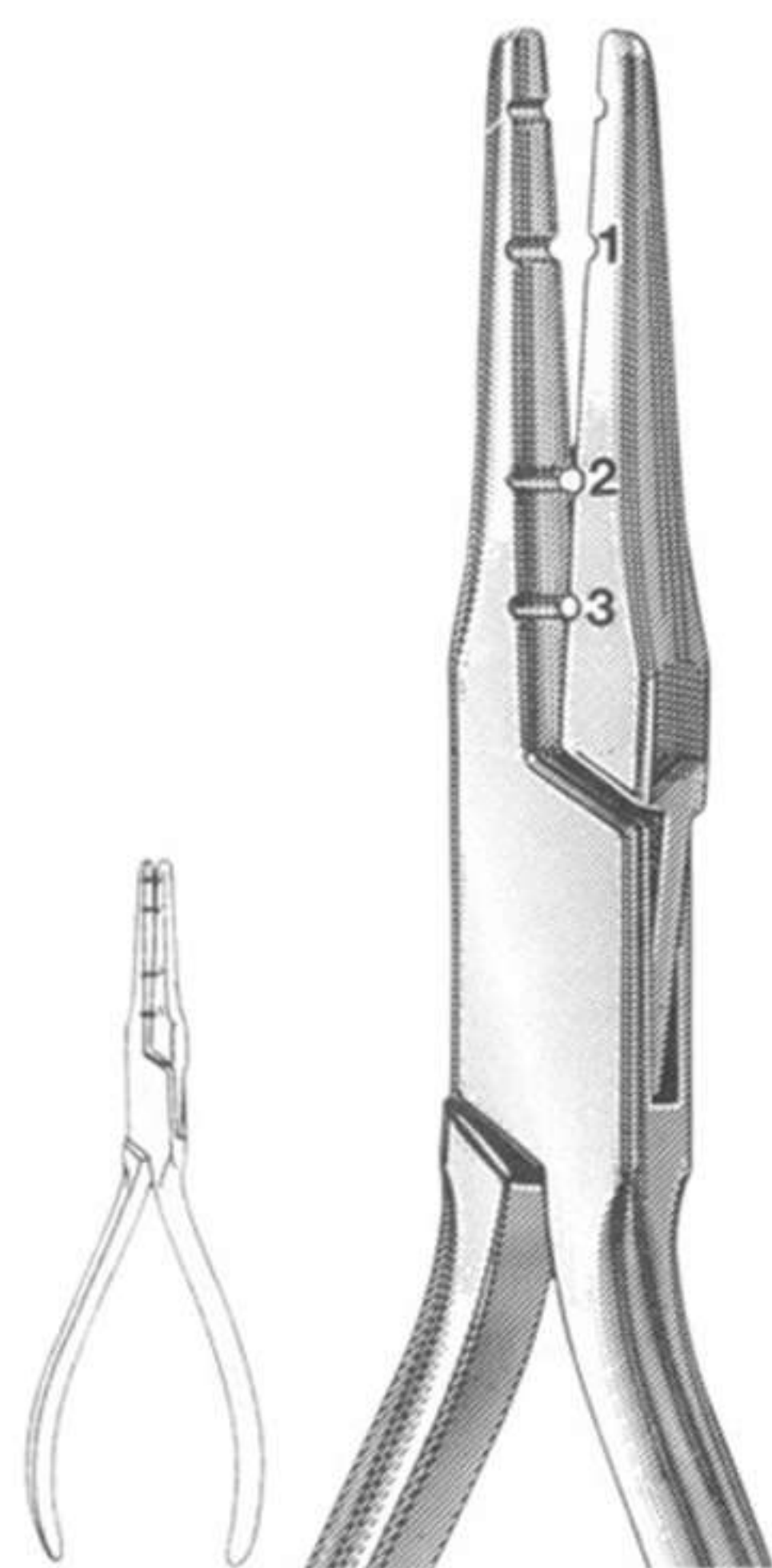

DMI-2-1901
Fig. 101 Wire Bending

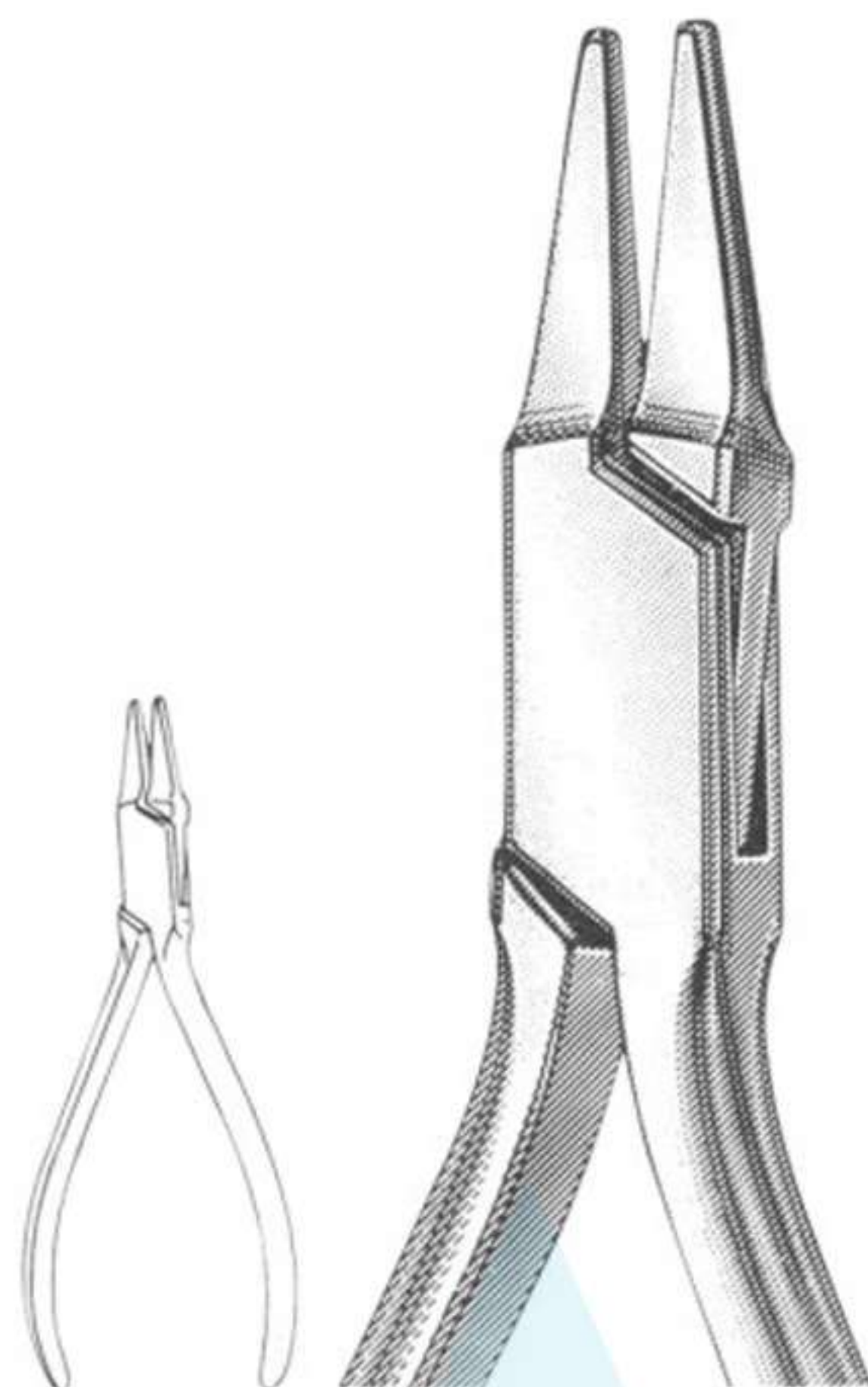

DMI-2-1902
Fig. 118 PEESO Collar

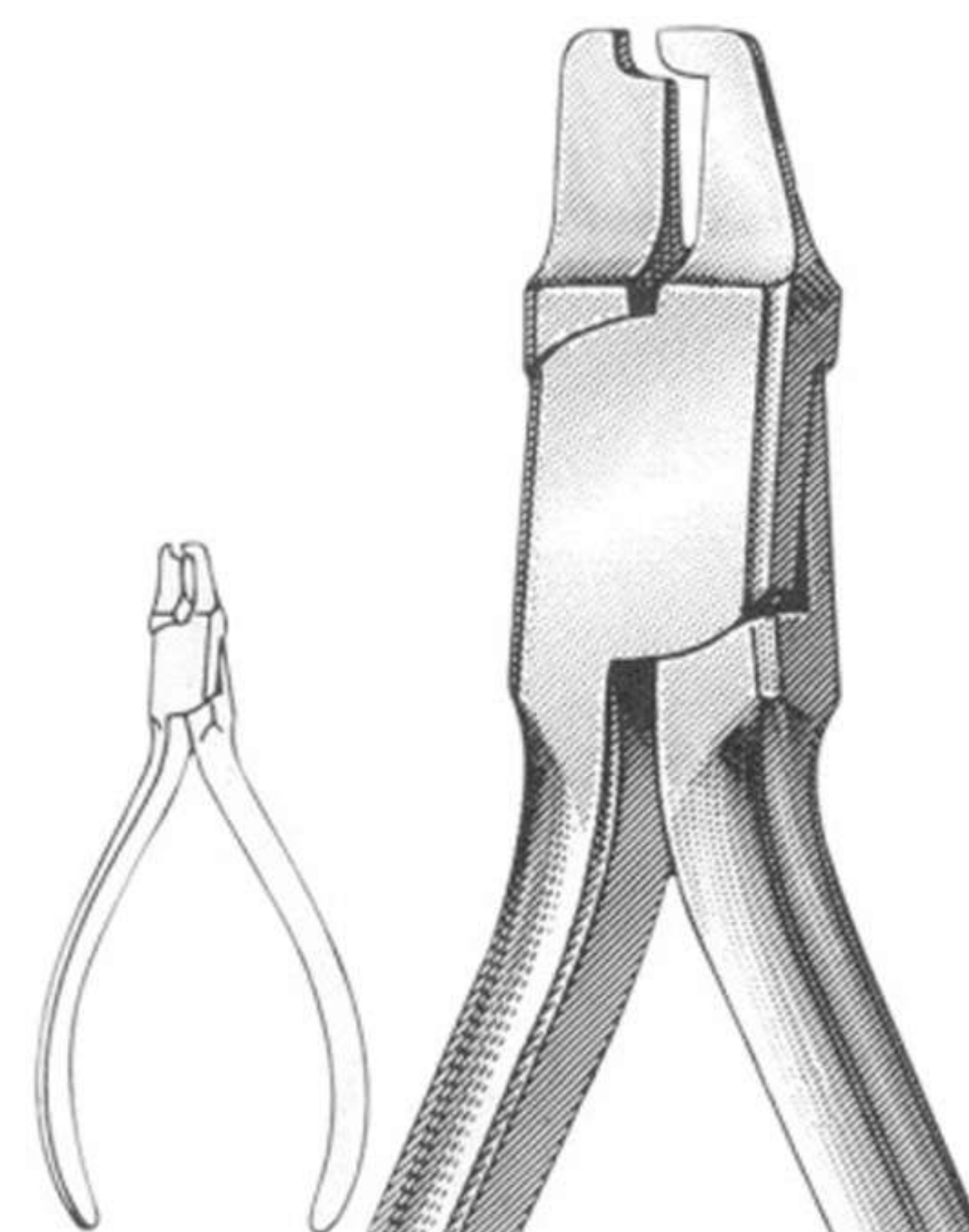

DMI-2-1903
Fig. 417 Crown Shell

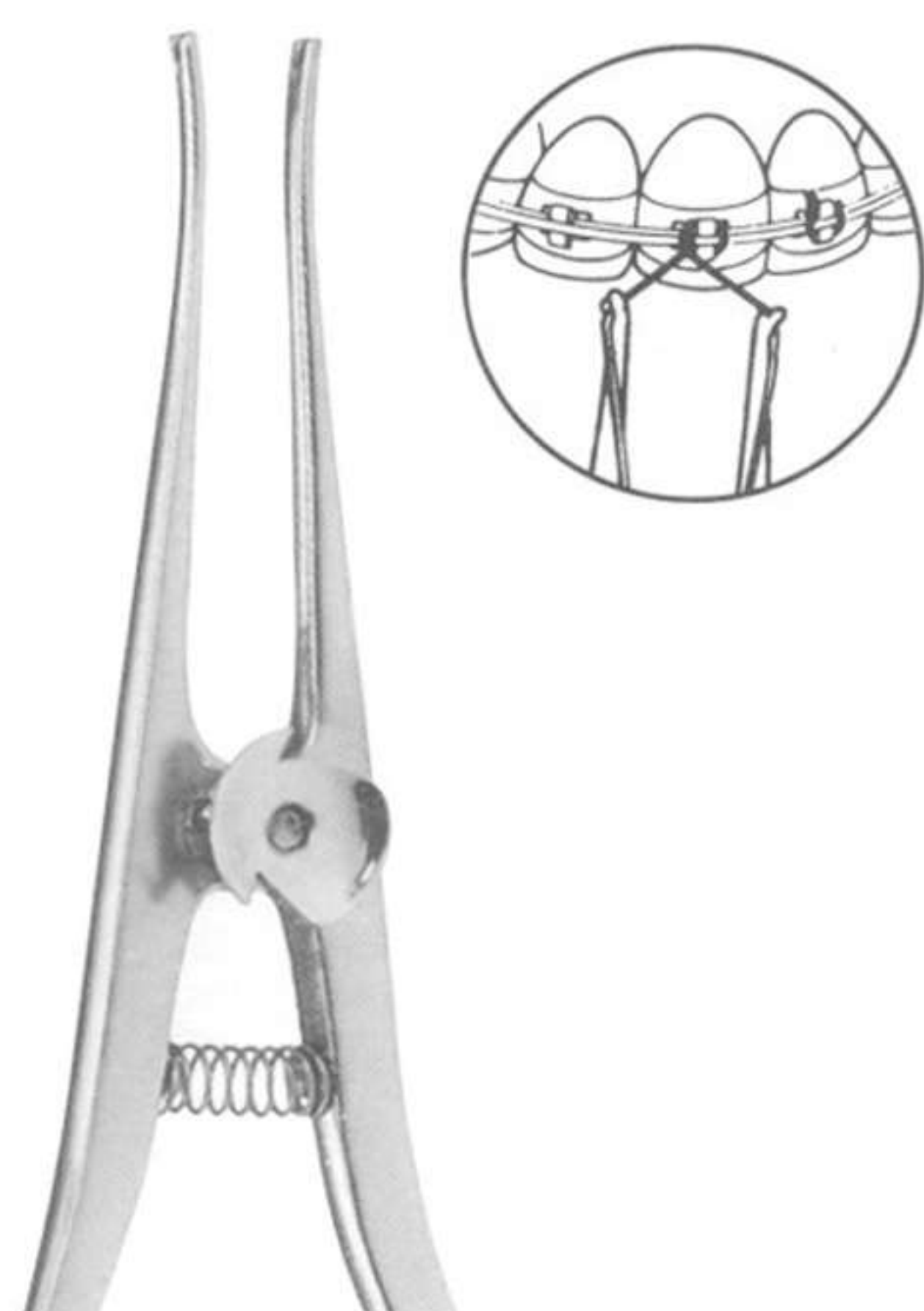

DMI-2-1904
STEINER 150 mm Ligature Pliers

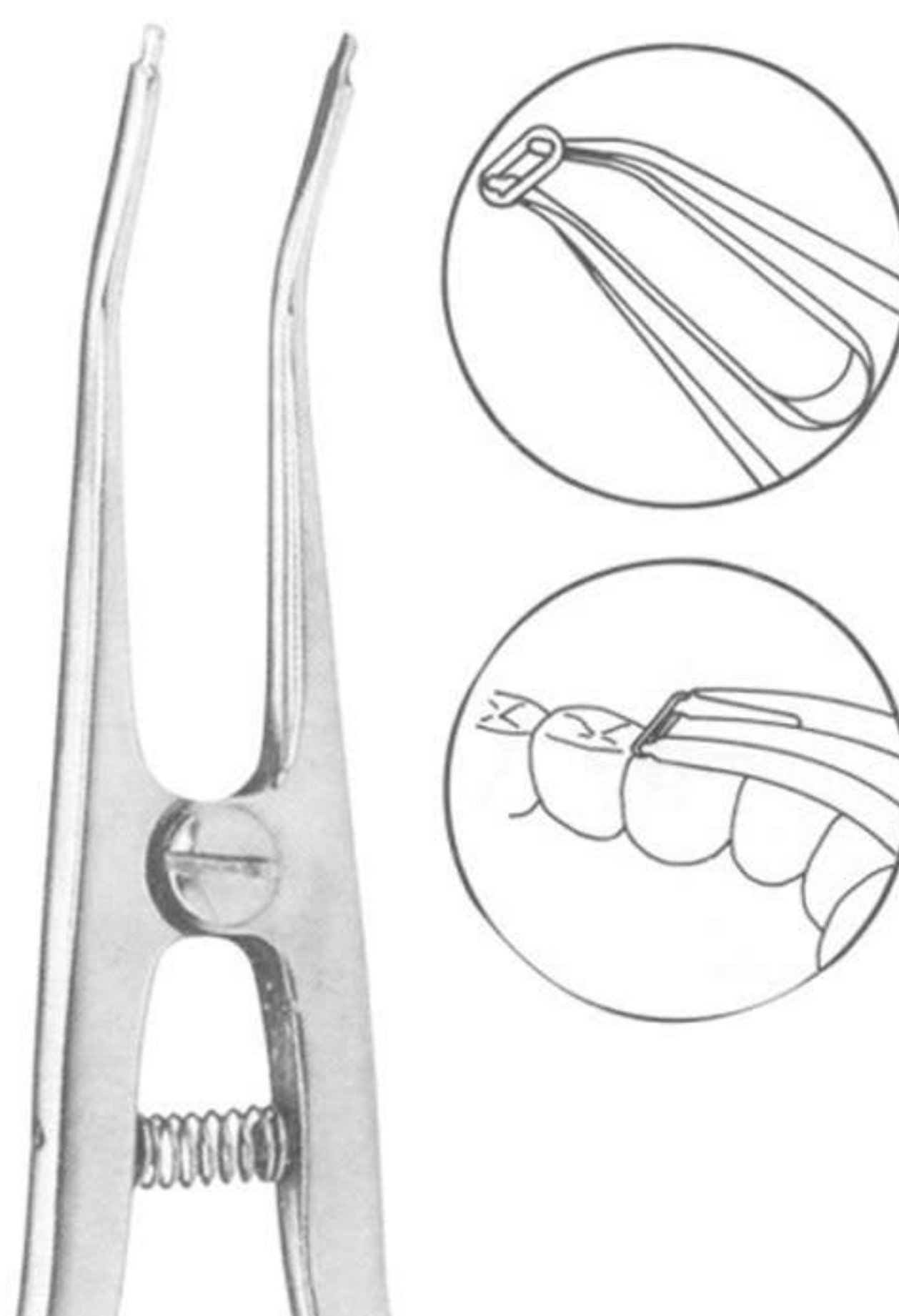

DMI-2-1905
Separating Pliers Elastics 150 mm

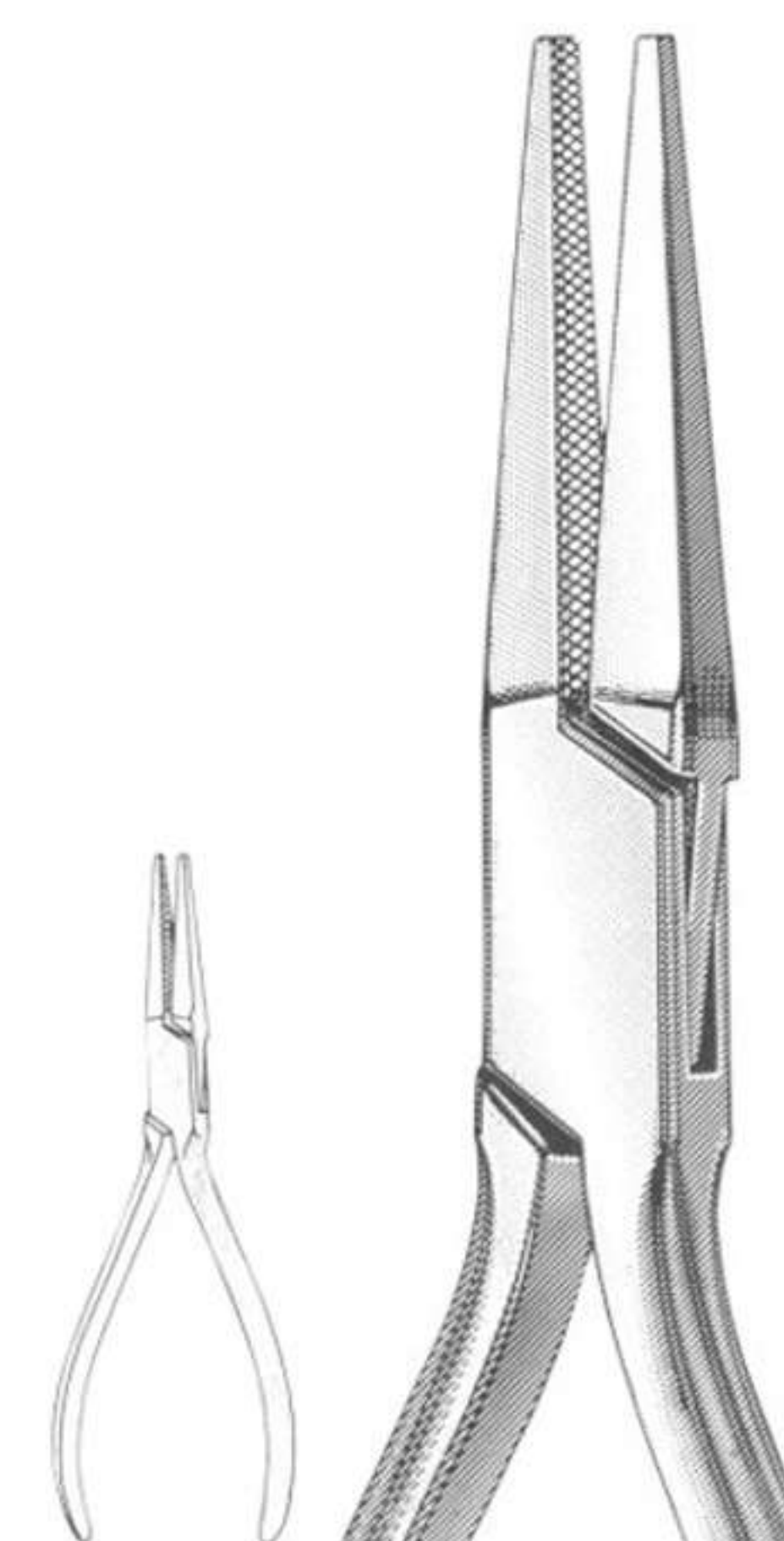

DMI-2-1906
121-Lab & Office

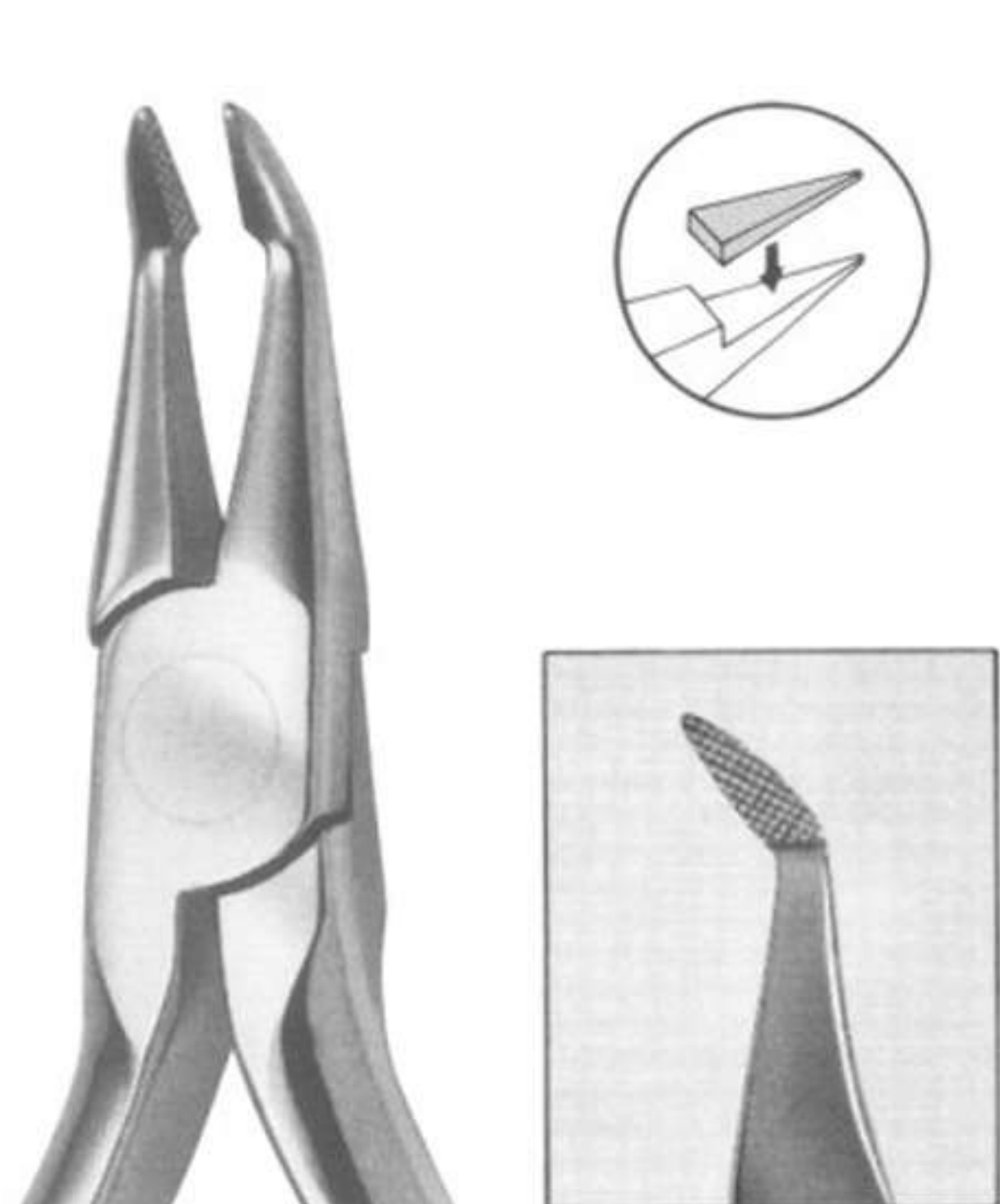

DMI-2-1913
Weingart Utility Plier New type of the Weingart Utility Plier designed for a more precise operation.

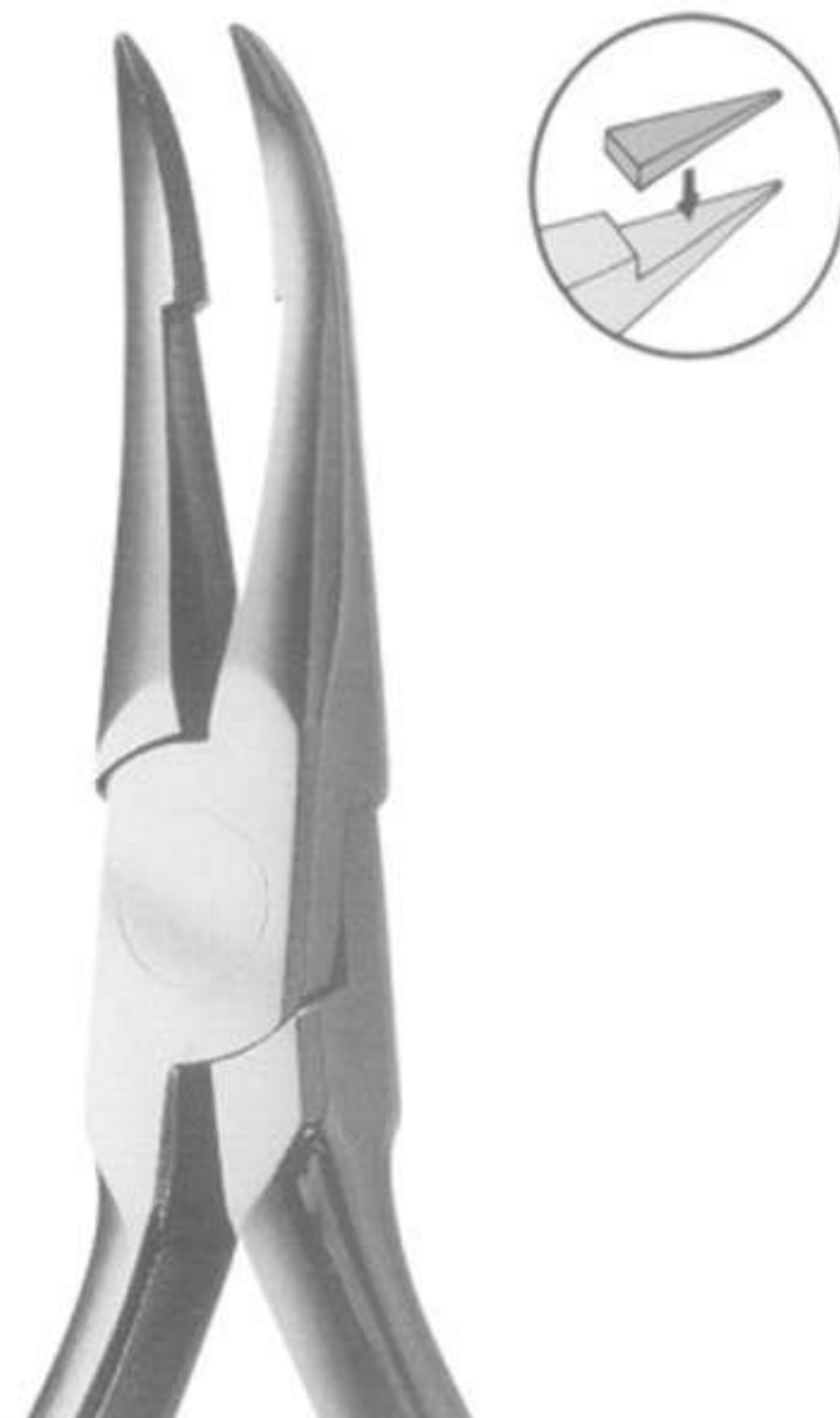

DMI-2-1914
Weingart Utility Plier

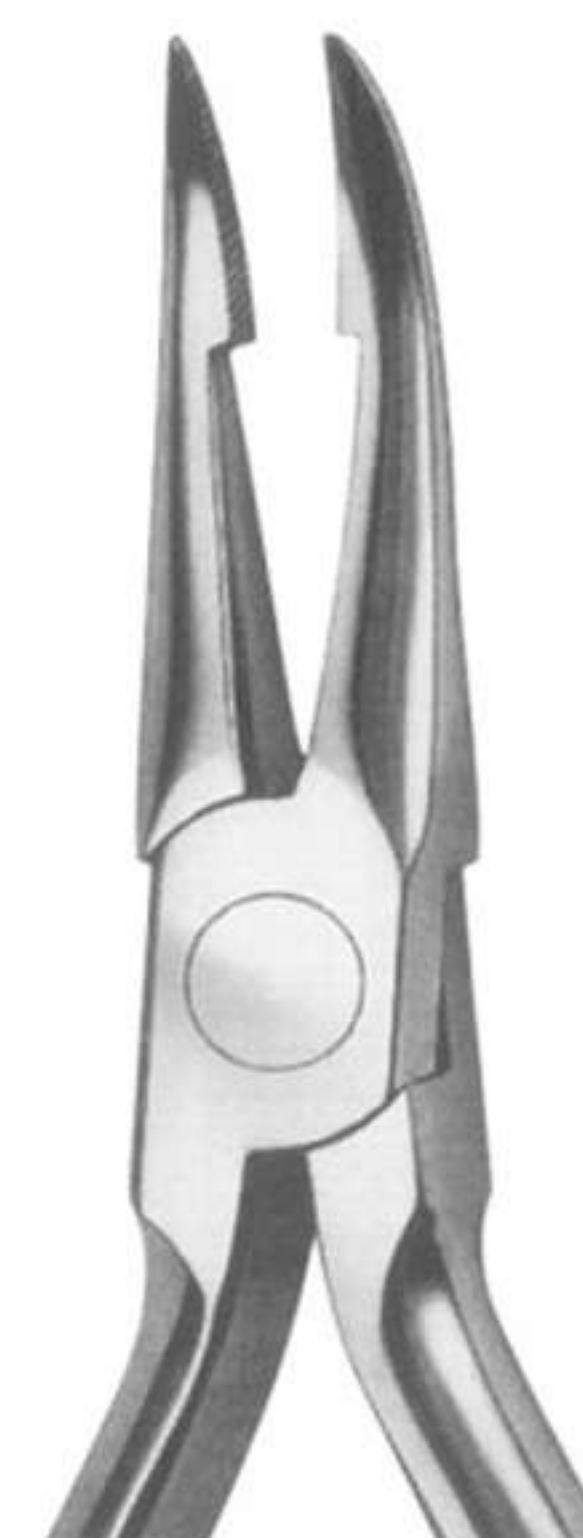

DMI-2-1915
Weingart Utility Plier

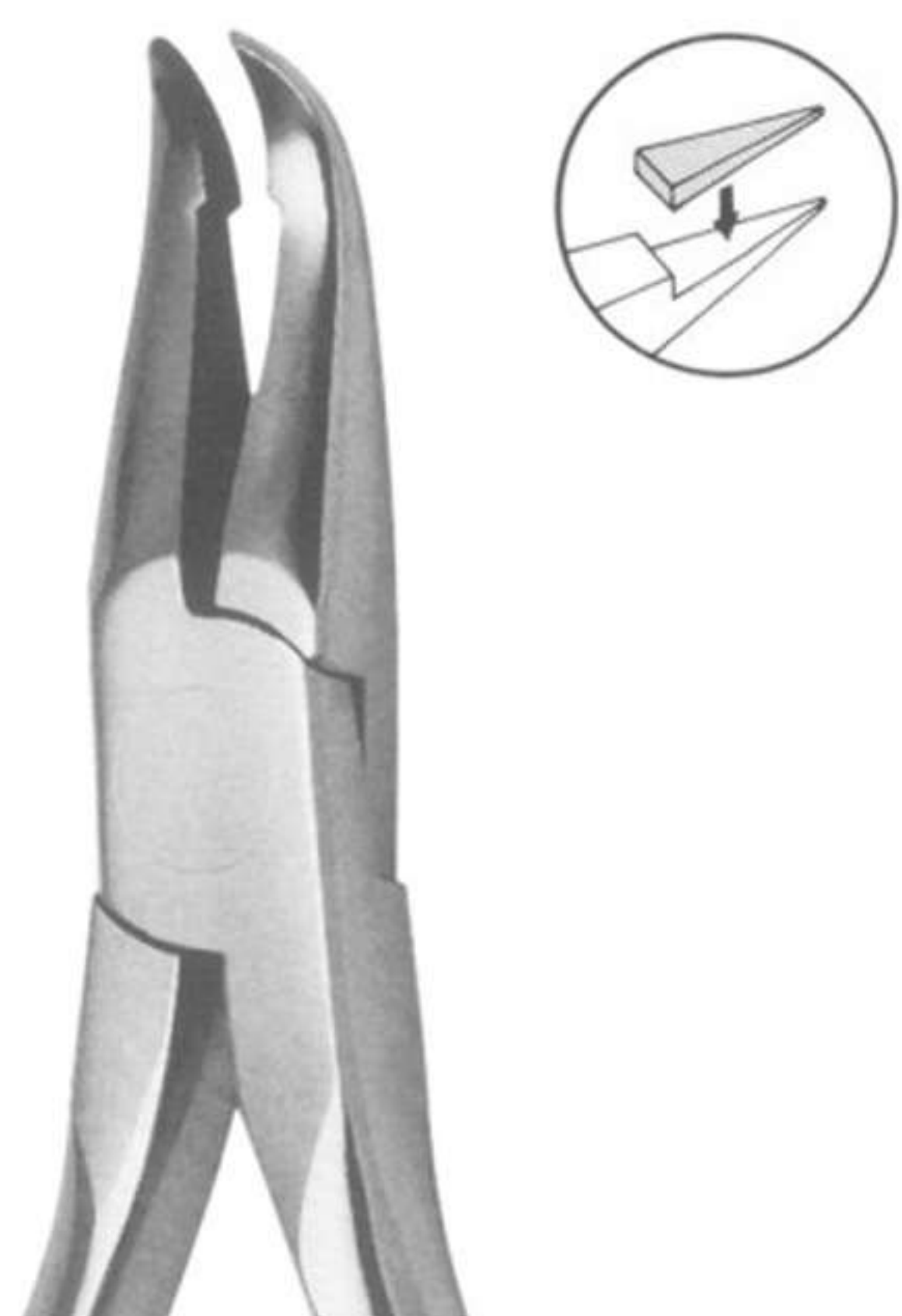

DMI-2-1916
Weingart Utility Plier

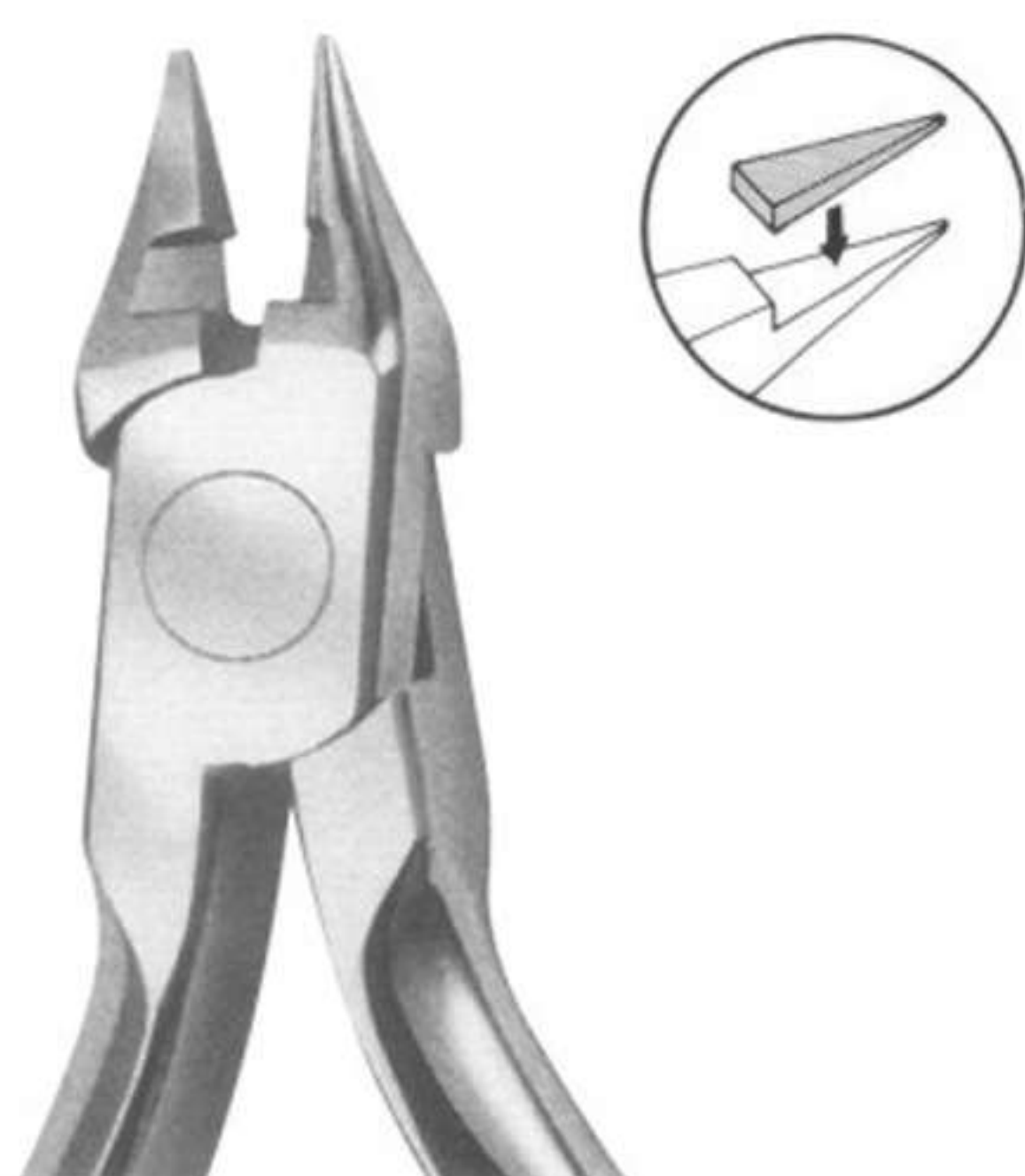

DMI-2-1917
Bird Beak Plier With Cutter

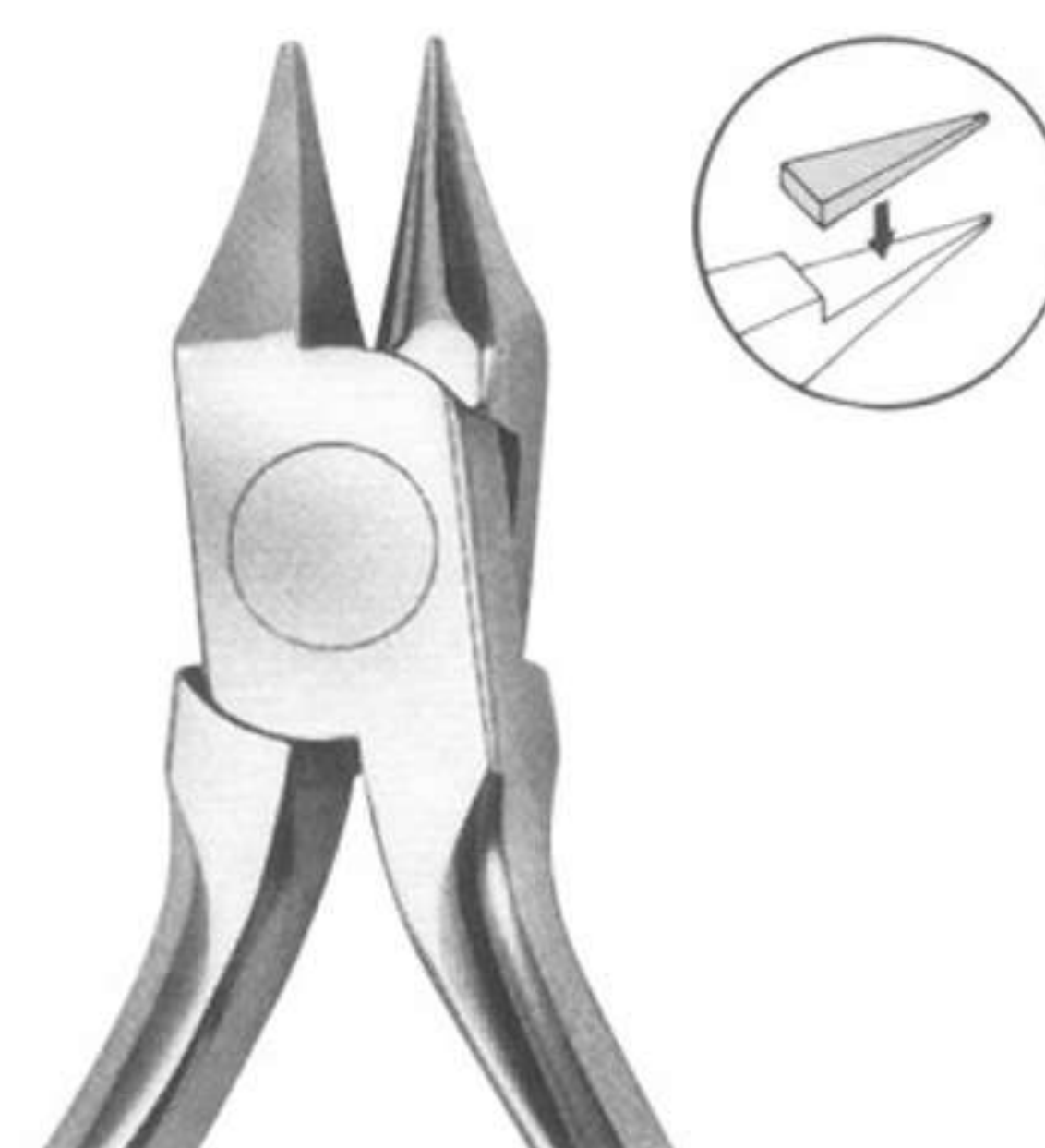

DMI-2-1918
Bird Beak Plier

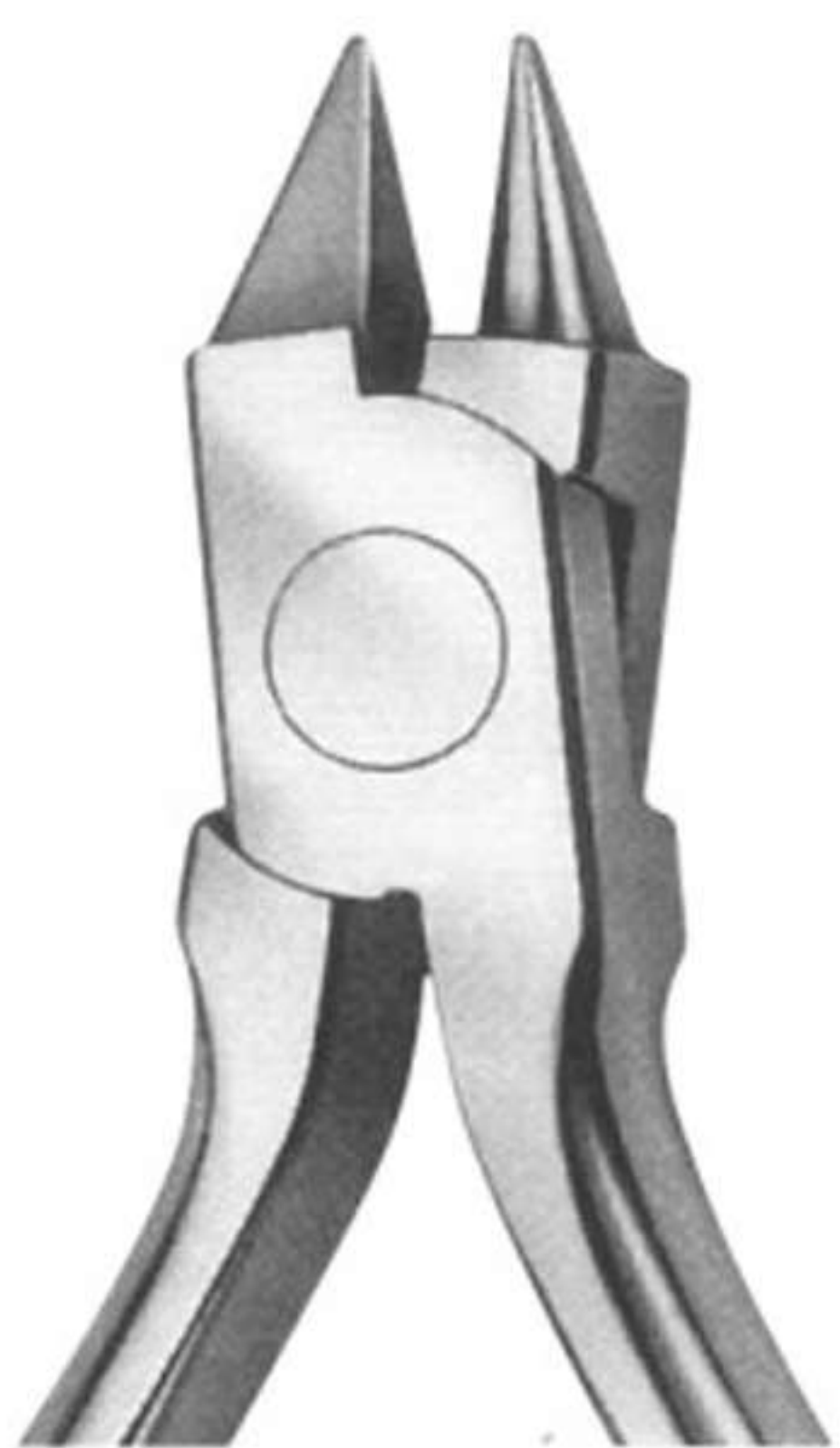

DMI-2-1919
Bird Beak Plier

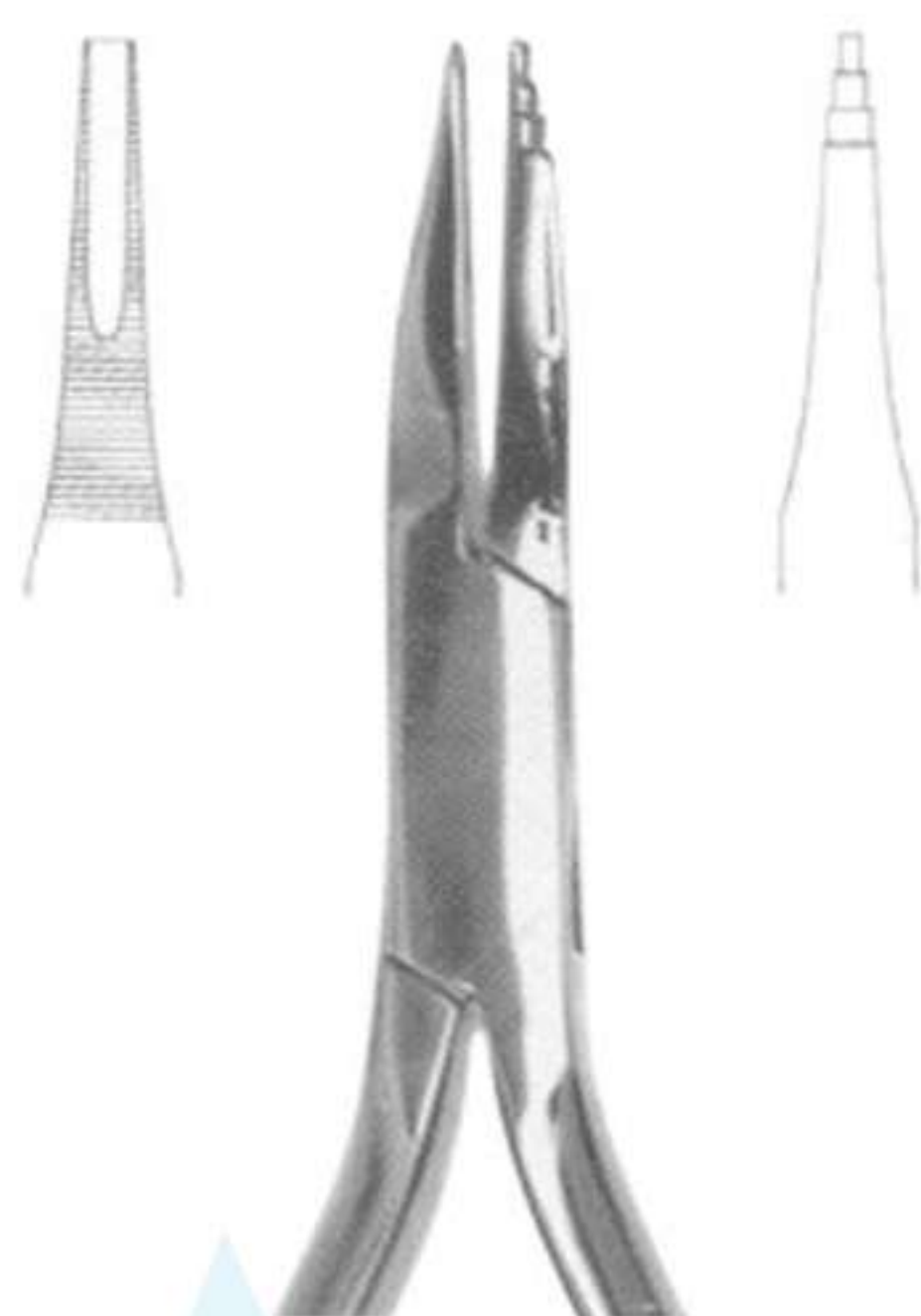

DMI-2-1920
TWEED - (Fig. 90) 14 cm, 5 1/2"

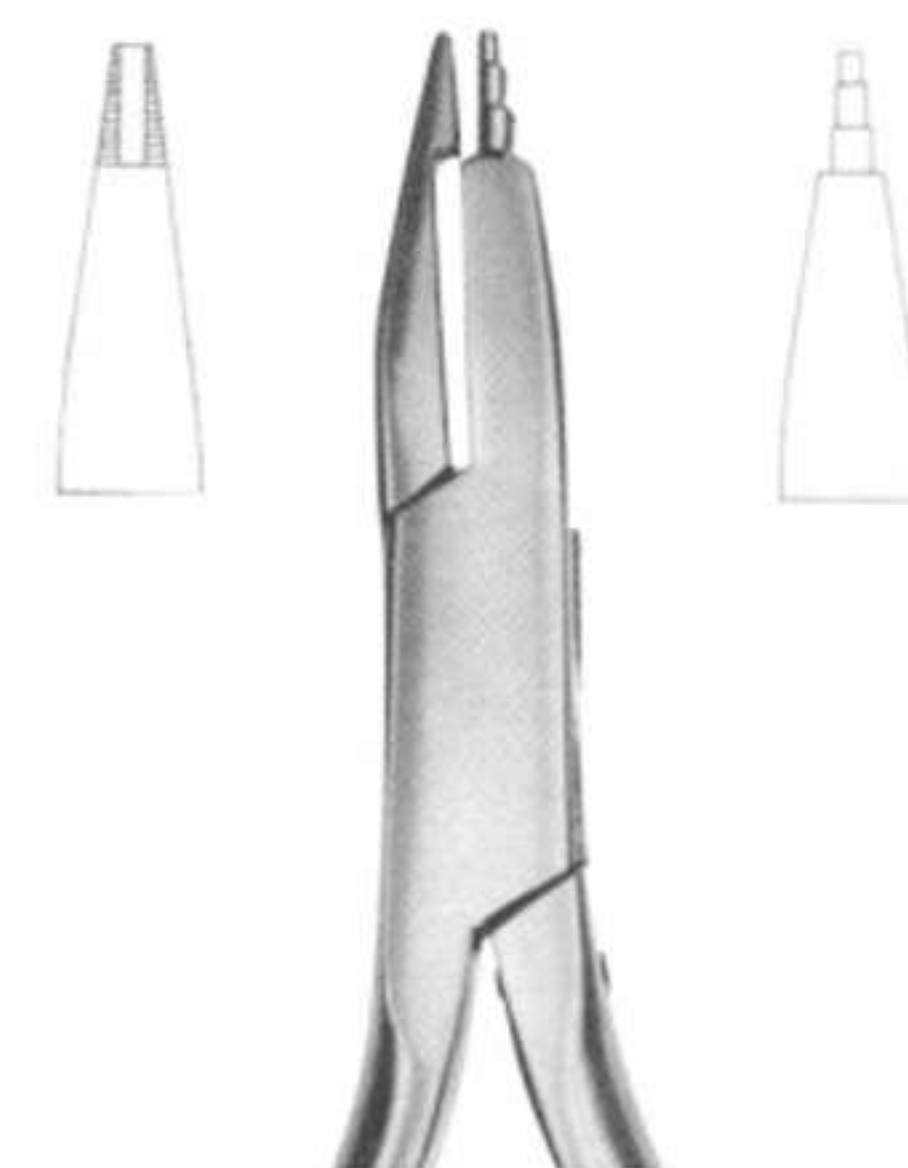

DMI-2-1921
O'BRIEN - (14 cm, 5 1/2" Fig. 97)



DMI-2-1922
TWEED (Fig. 98) 13 cm,
5 1/8" Tweed Loop Omega Pliers.

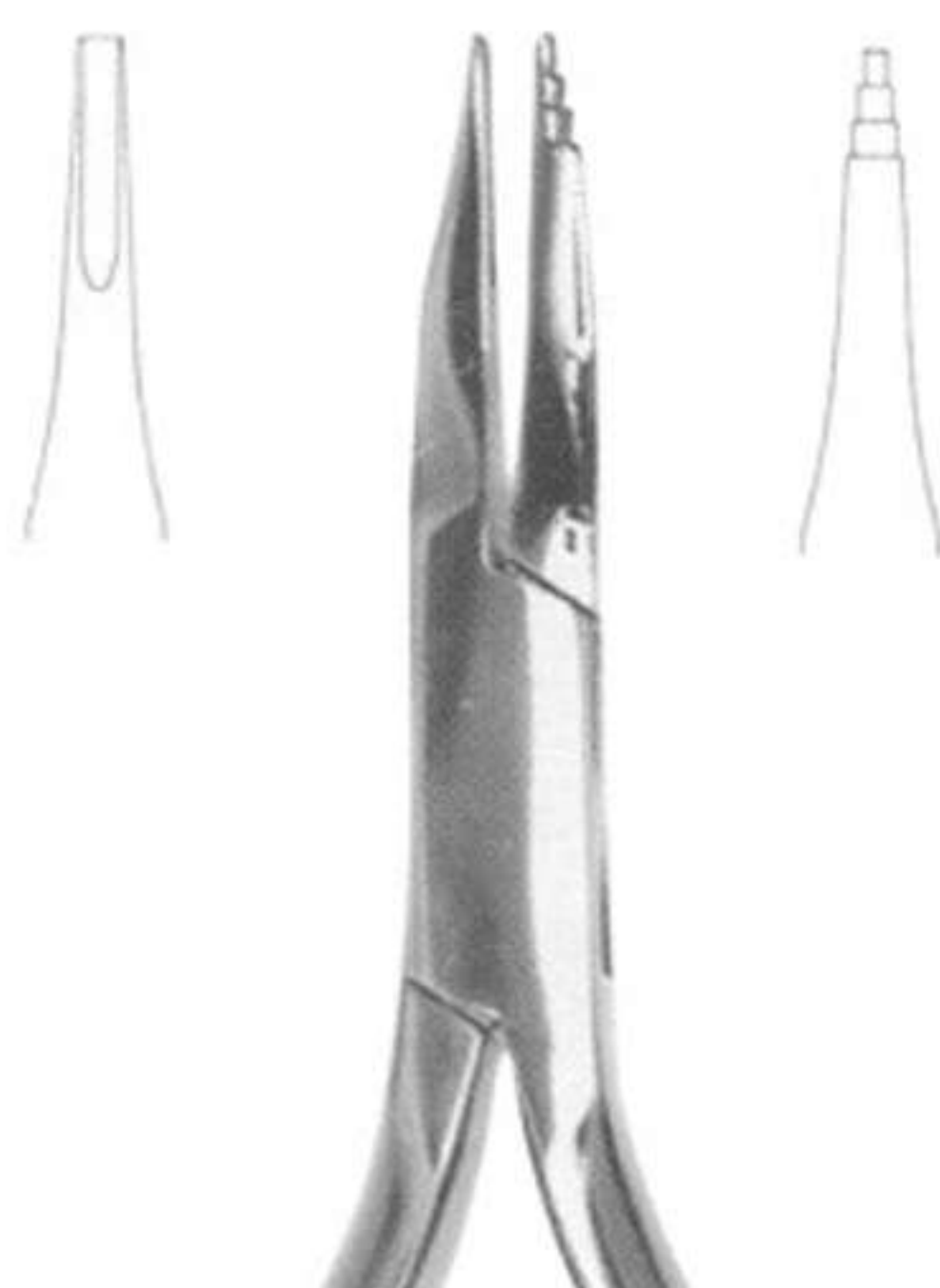

DMI-2-1923
TWEED (Fig. 96) 14 cm, 5 1/2"

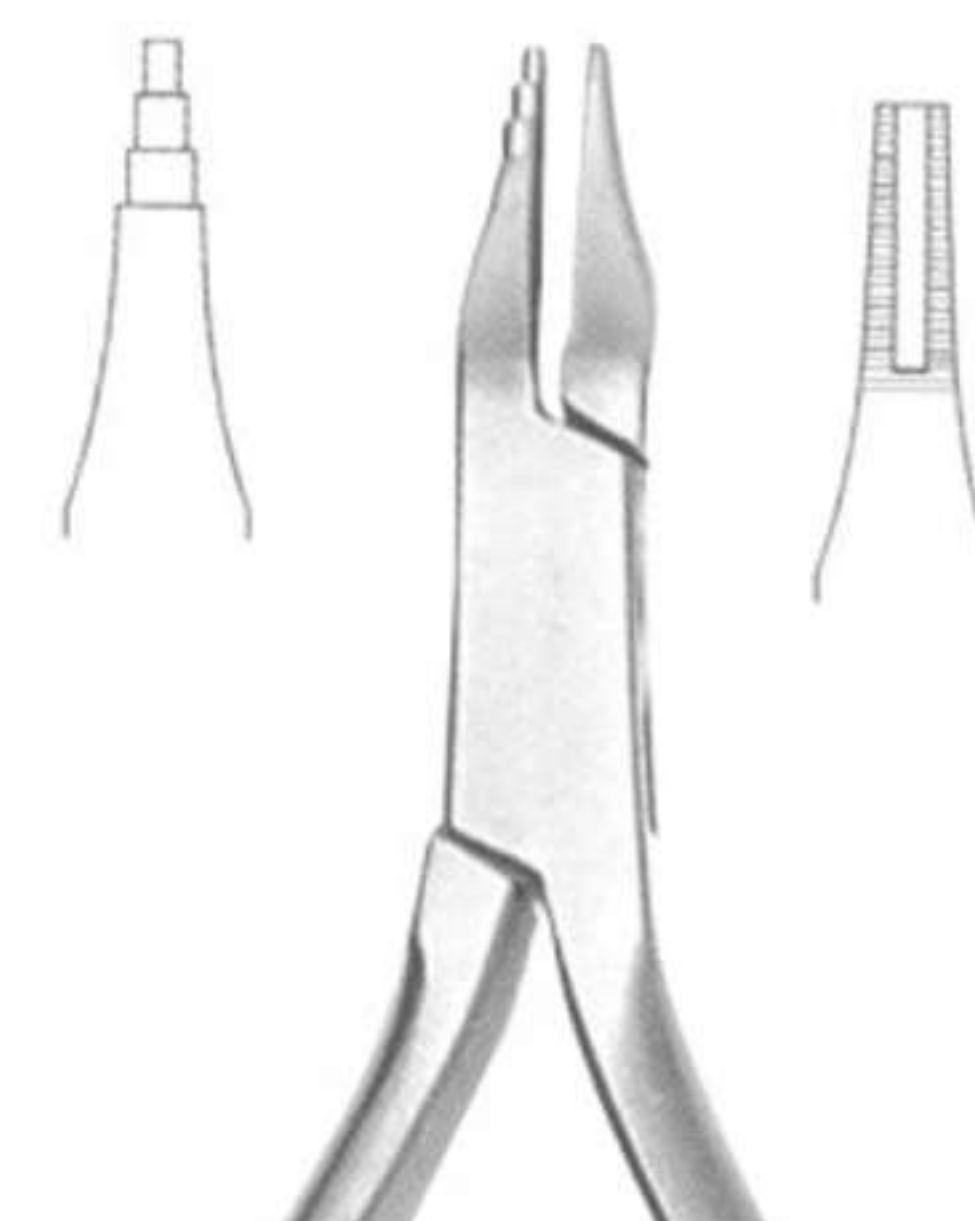

DMI-2-1924
TWEED (Fig. 95) 13.5 cm, 5 1/4"

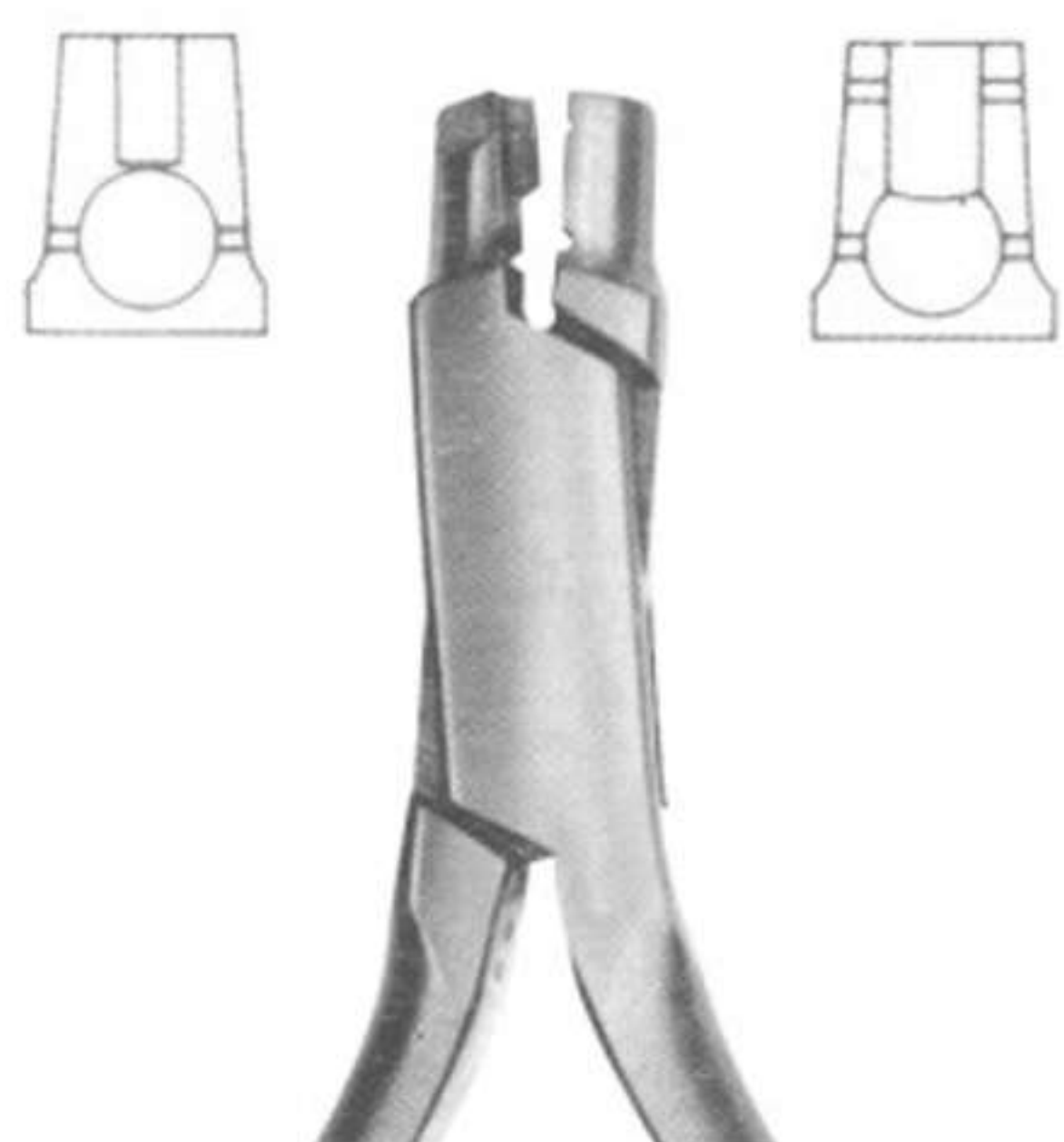

DMI-2-1925
SCHWARZ (Fig. 29) 12.5 cm, 5"

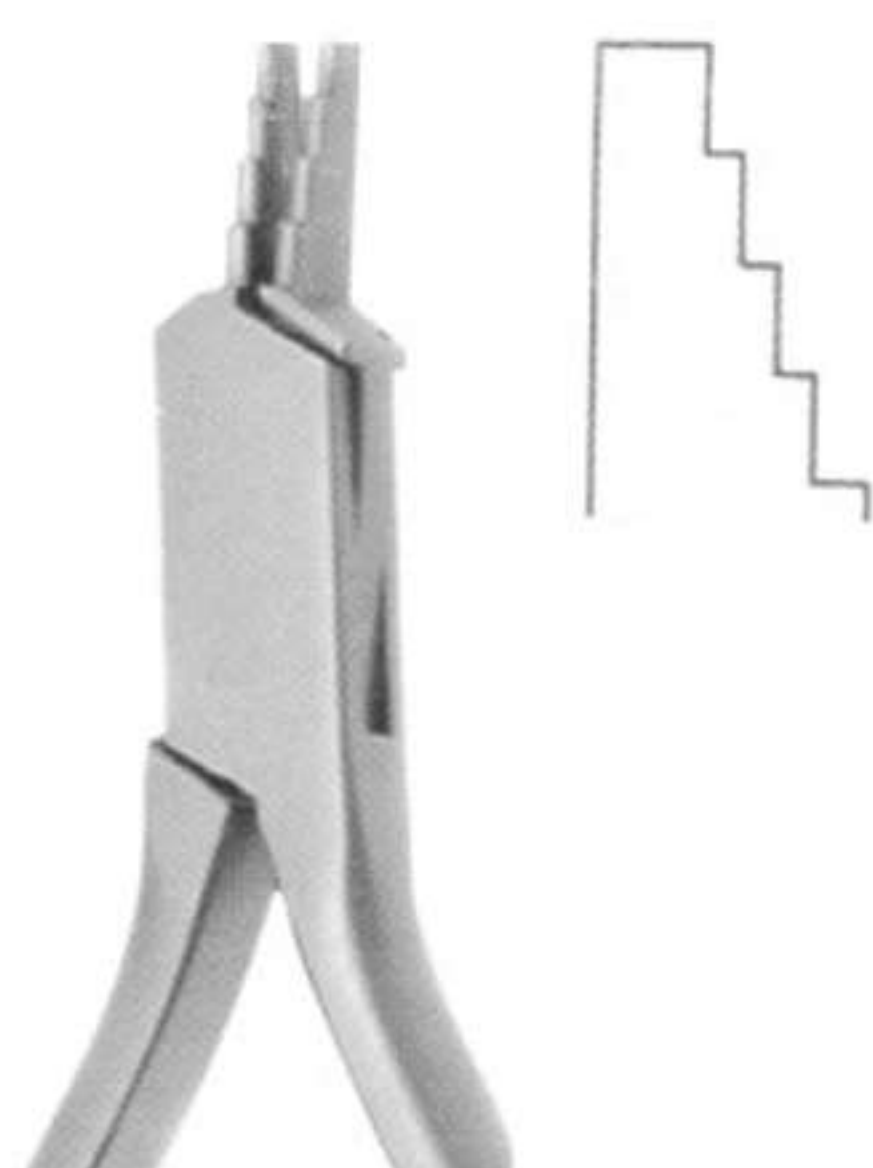

DMI-2-1926
NANCE (Fig. 80) 13 cm, 5 1/8"

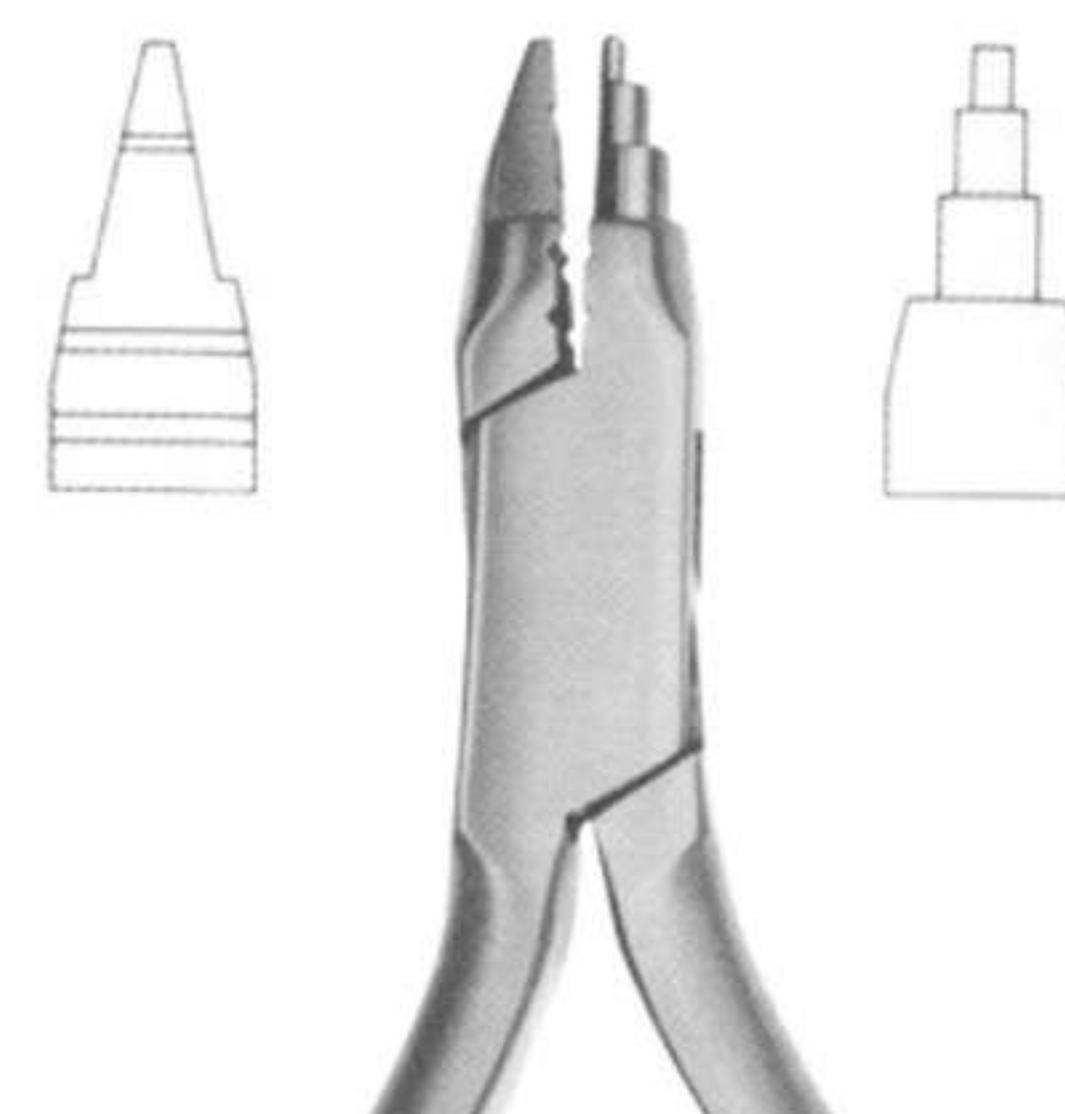

DMI-2-1927
YOUNG (Fig. 55) 13 cm, 5 1/8"

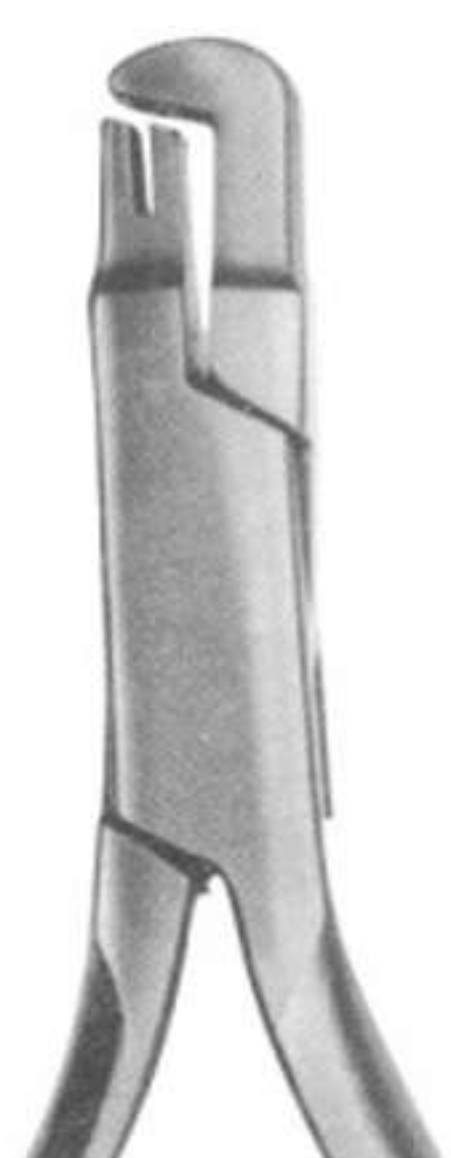
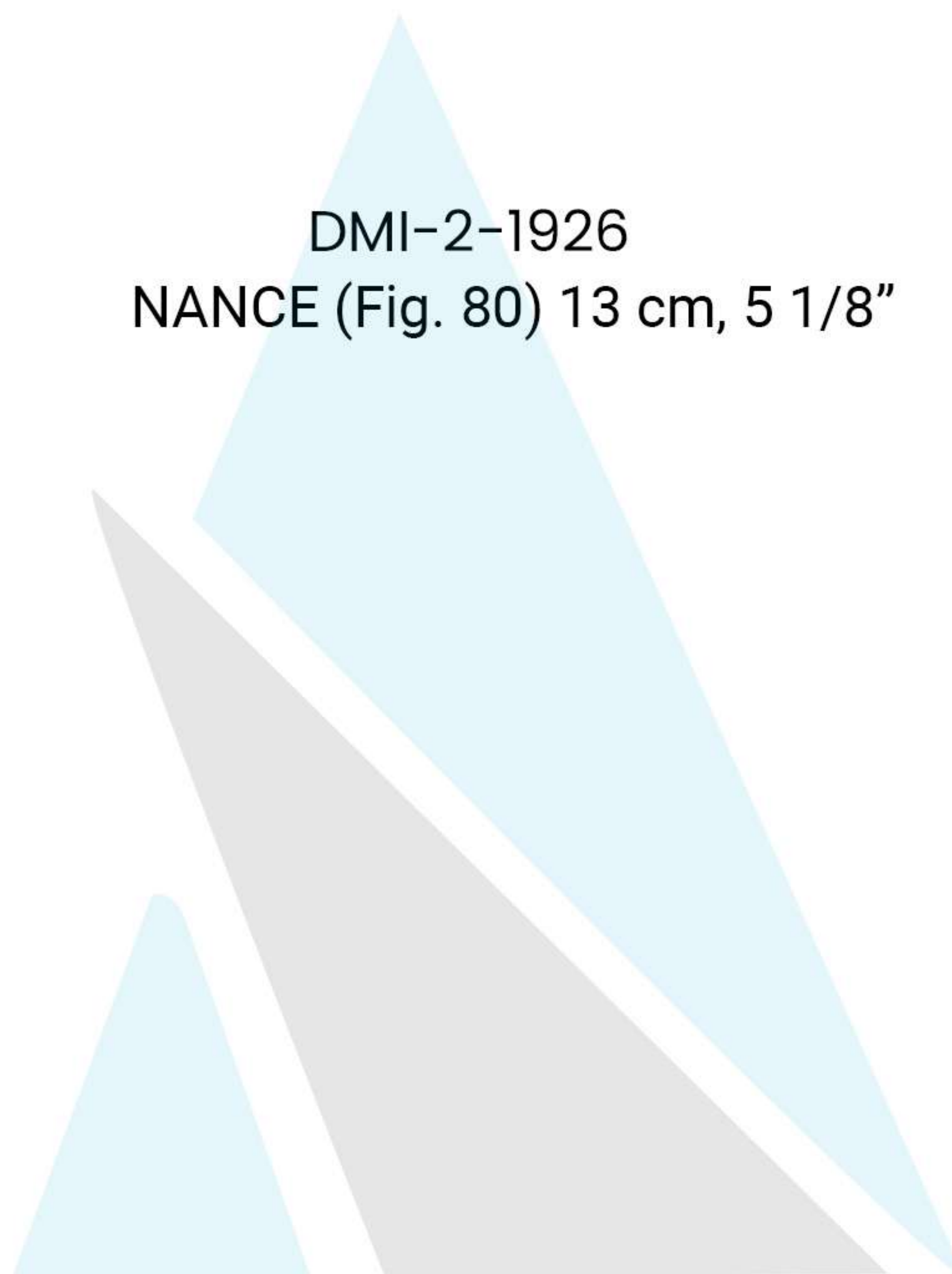

DMI-2-1928
SCHWARZ (Fig. 30) 13 cm, 5 1/8"

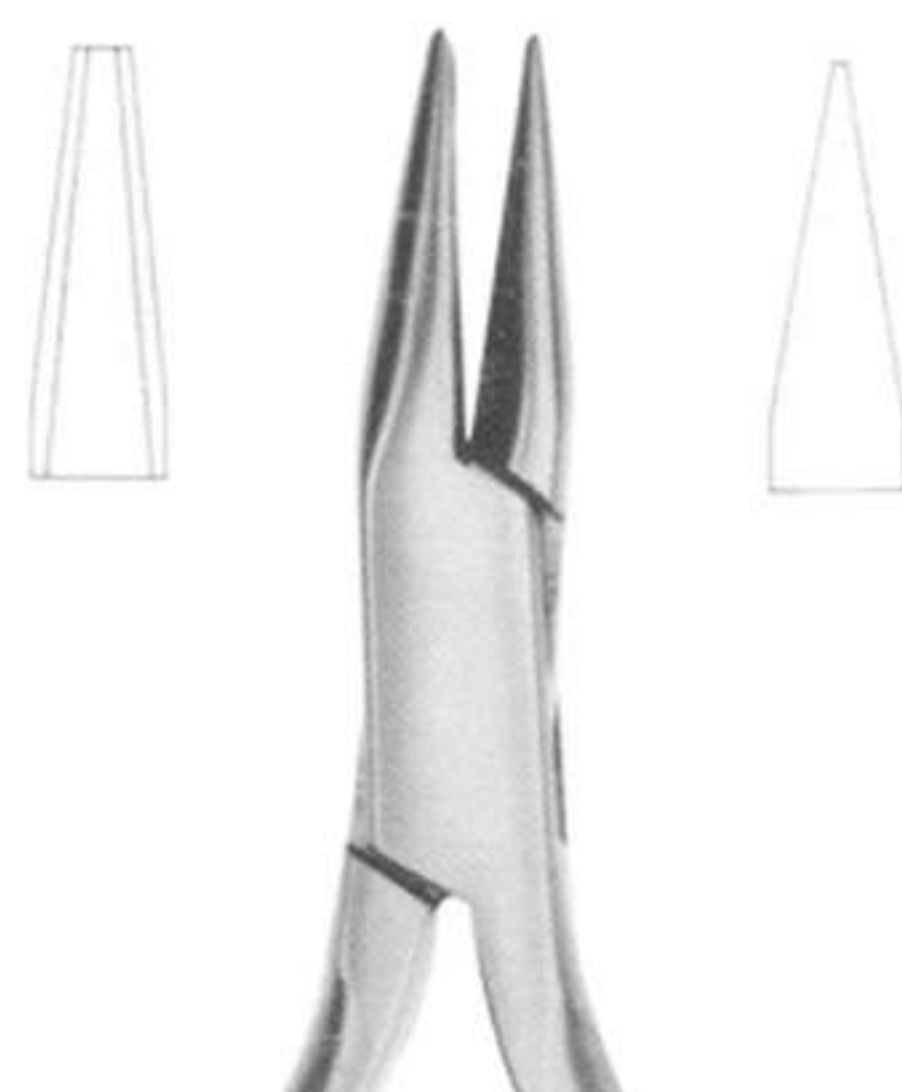

DMI-2-1929
Optical Plier (Fig. 53) 14 cm, 5 1/2"

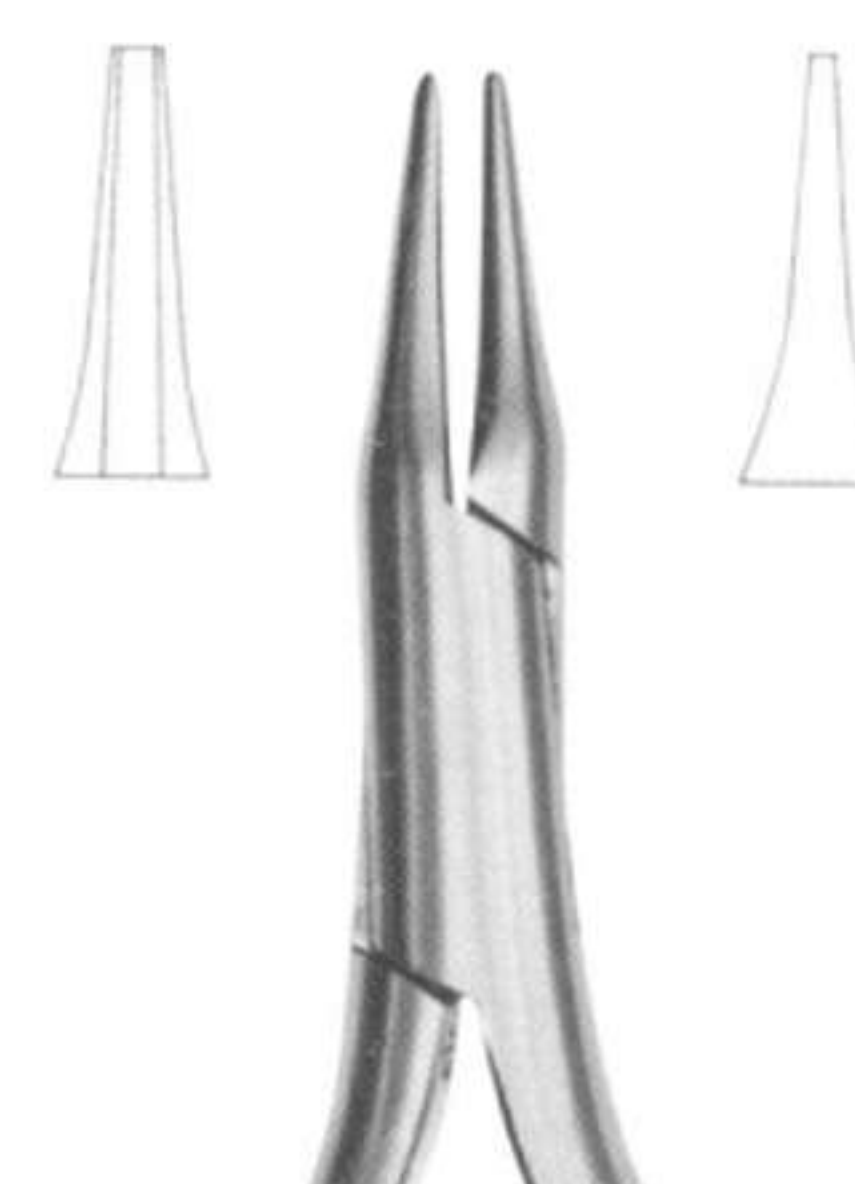

DMI-2-1930
Schwarz (Fig. 79) 13.5 cm, 5 1/4"



DMI-2-1931
Fig. 60 13 cm, 5 1/8"
Wire & Clasp Bending Pliers

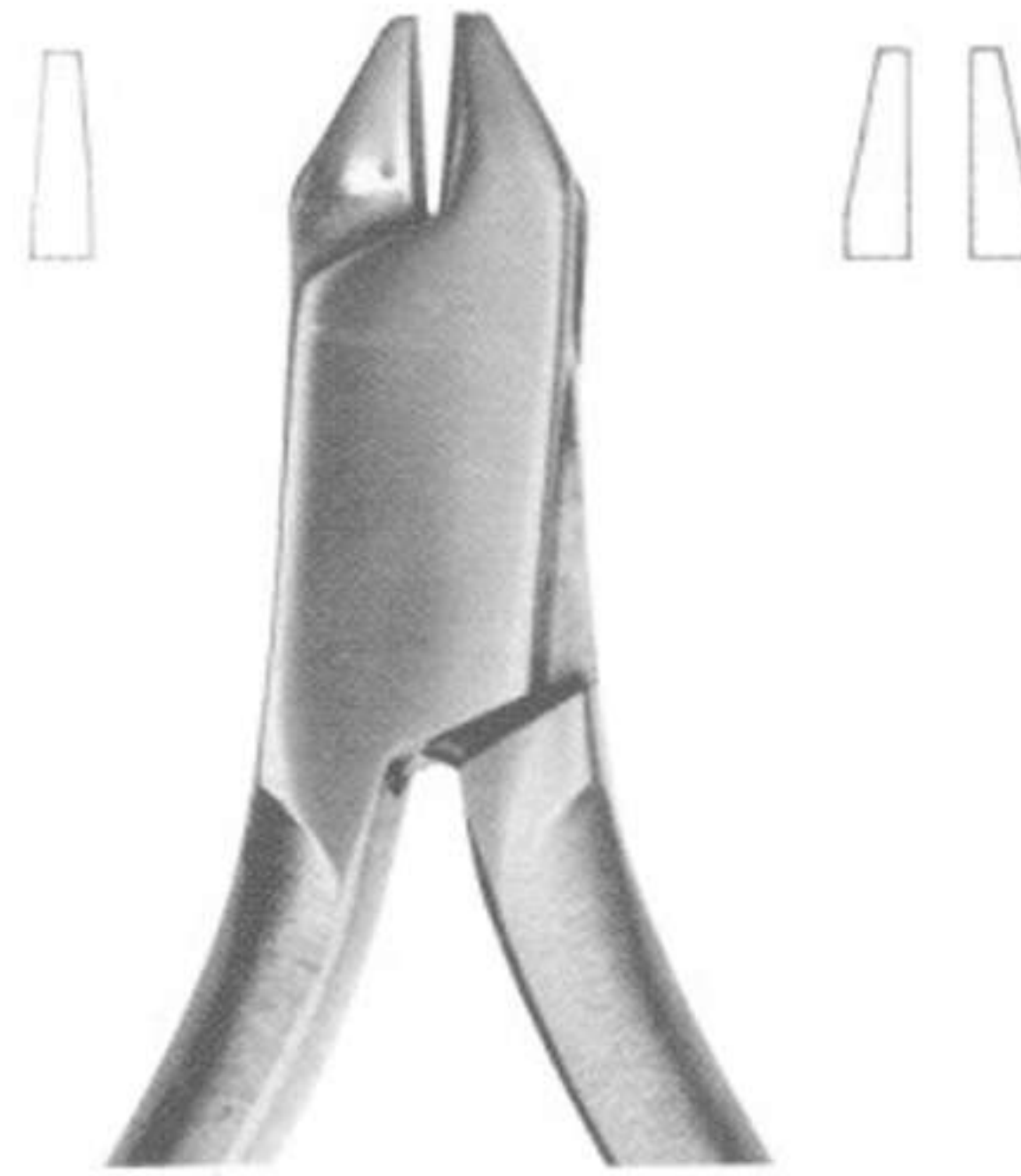

DMI-2-1932
Fig. 60 13 cm, 5 1/8"
Wire & Clasp Bending Pliers

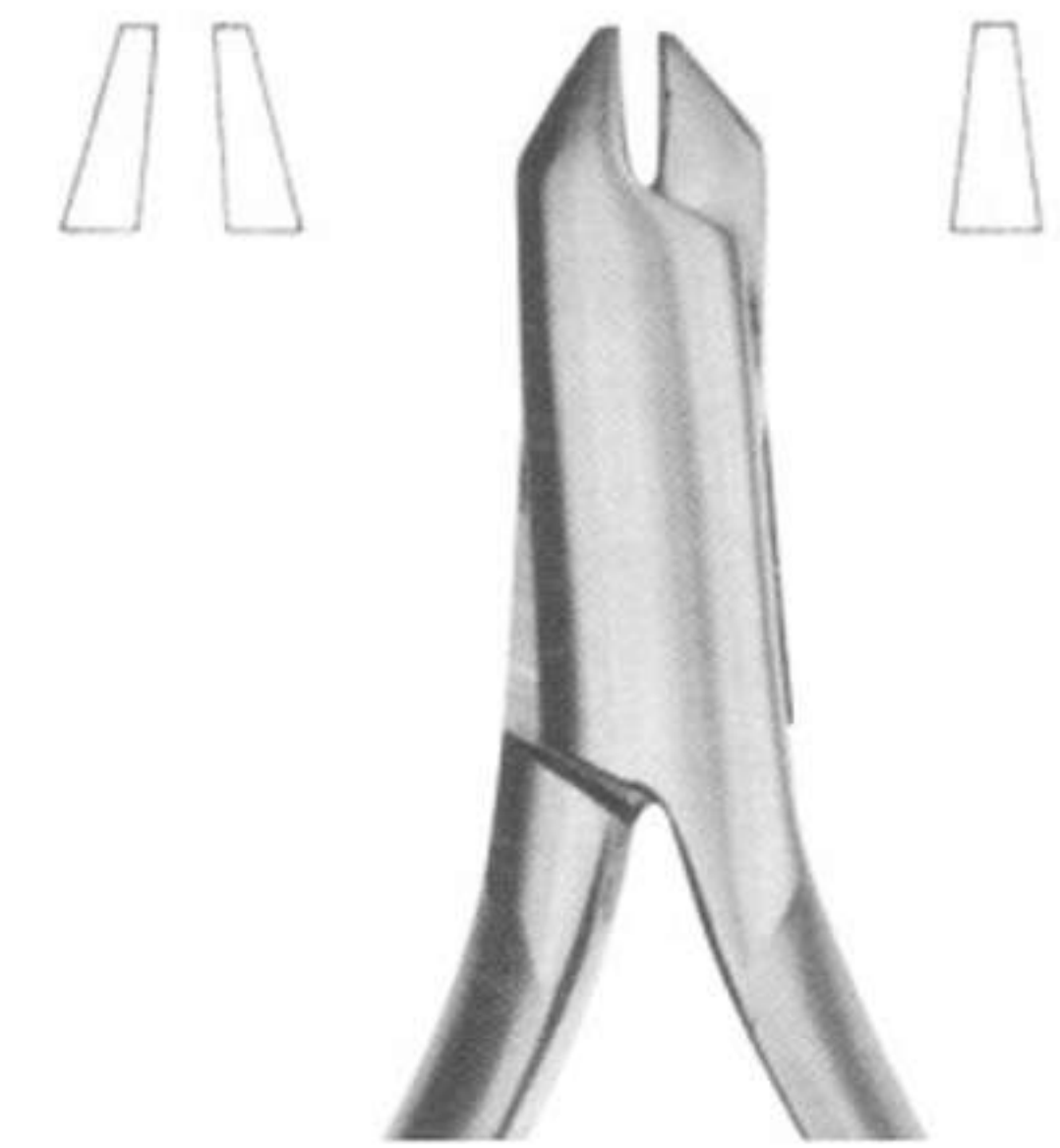

DMI-2-1933
Aderer (Fig. 57) 12 cm, 4 3/4"
Wire & Clasp Bending Pliers



DMI-2-1934
49 e 49 TC 14 cm, 5 1/2"
Band Removing Plier, short pad



DMI-2-1935
50 e 50 TC 14 cm, 5 1/2"
Band Removing Plier, long pad

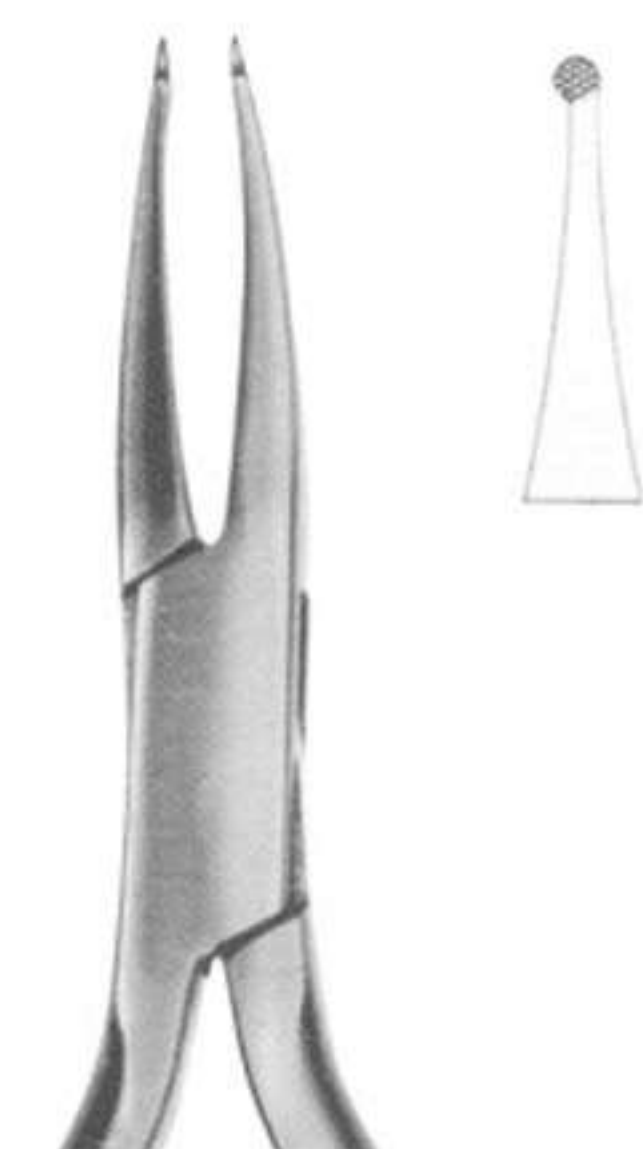

DMI-2-1936
Fig. 84 14.5 cm, 5 3/4"
Band pinshing & ligature
locking plier,
serrated

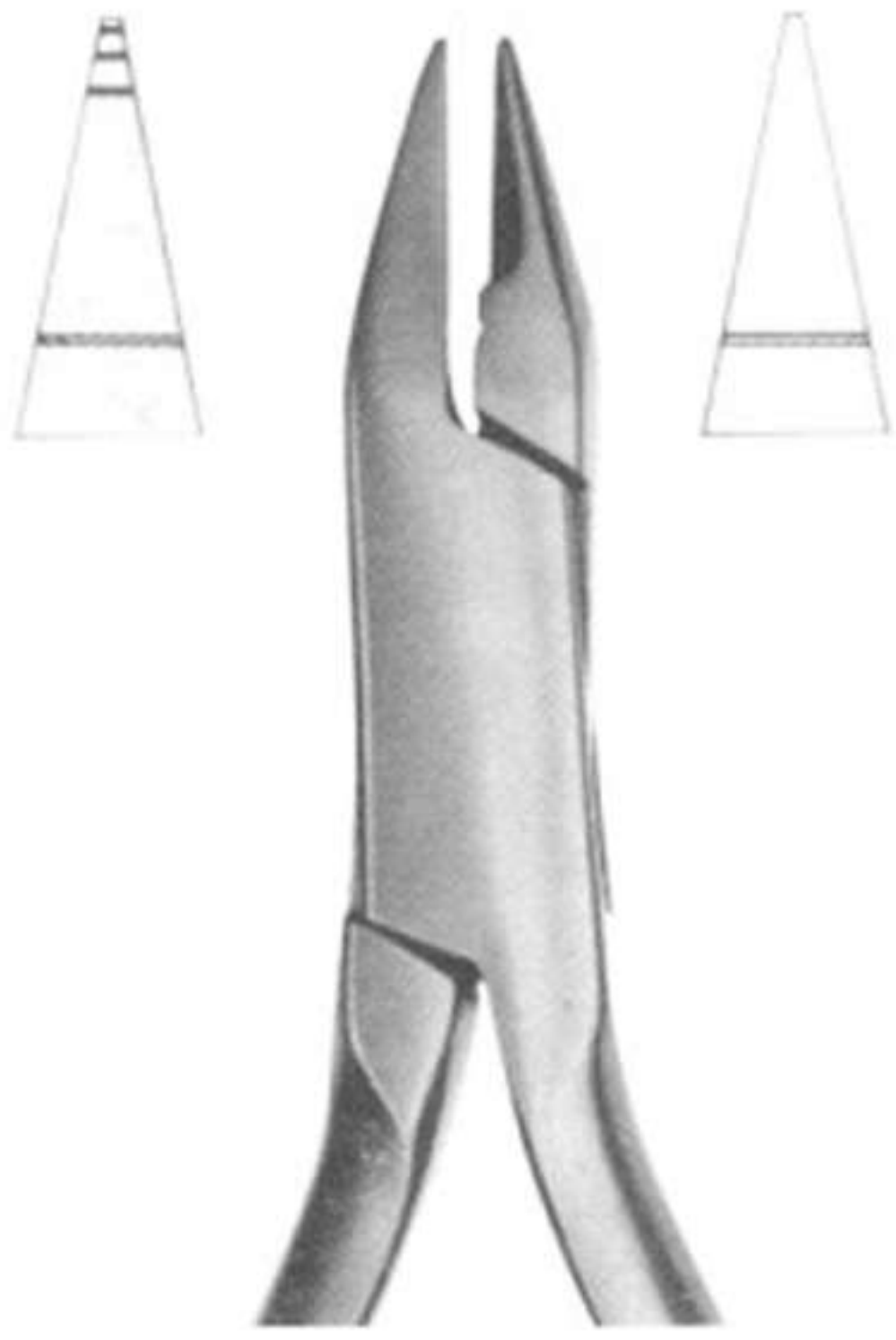

DMI-2-1943
Fig. 21 13 cm,
5 1/8" Light wires pliers, grooved

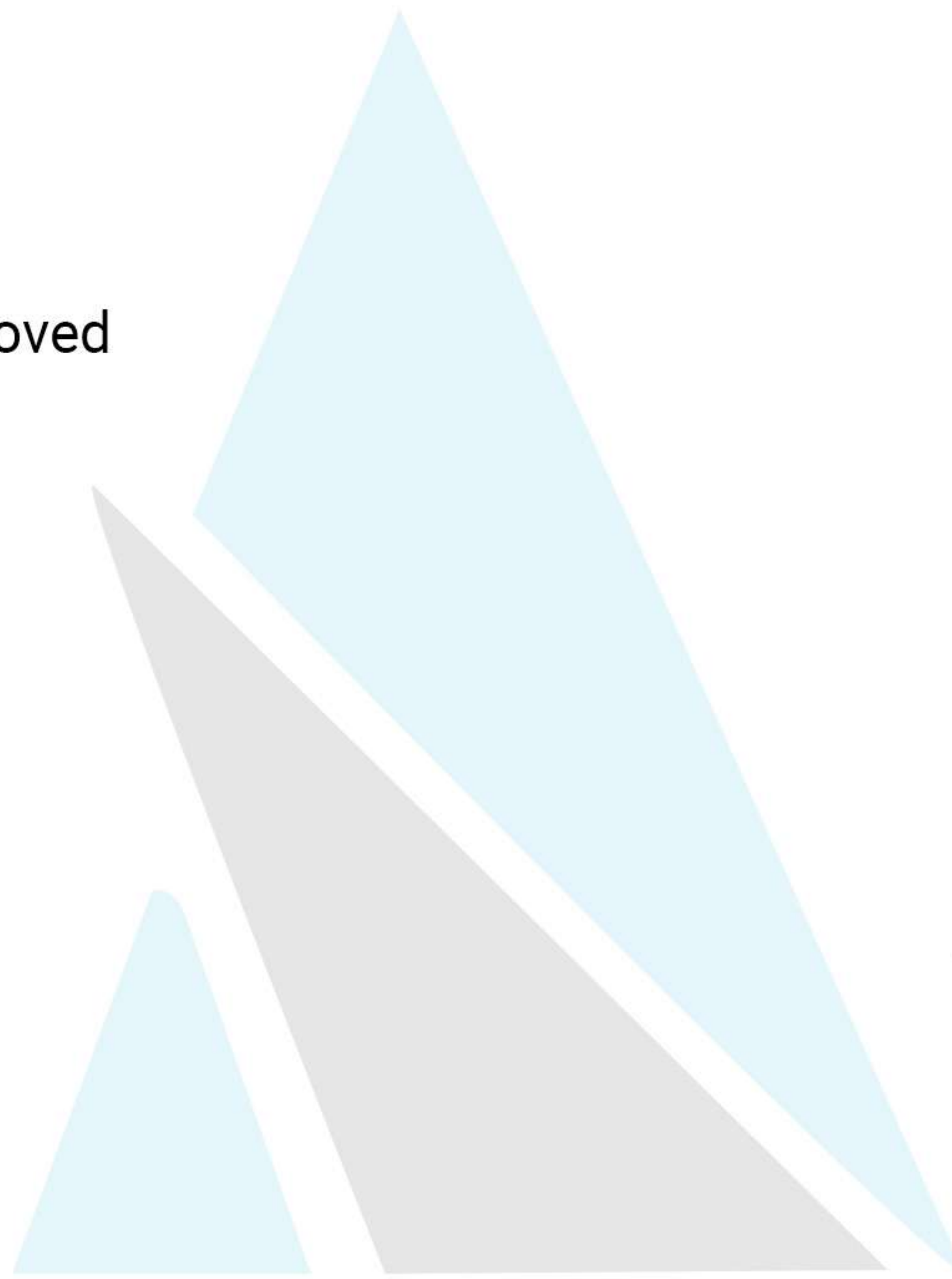

DMI-2-1944
46c - 46 TC ADAMS - N. 139c 12.5 cm,
5" Bird beak with

Needle Holders, Scissors, Micro Surgery Set



DMI-2-2001
COLLIER 5", Fenestrated Jaws



DMI-2-2002
DERF 4 3/4" DERF 4 3/4"



DMI-2-2003
WEBSTER Delicate Smooth Jaws 5"



DMI-2-2004
NEIVERT One Offset Ring 5"



DMI-2-2005
OLSEN-HEGAR 5 1/2"



DMI-2-2006
GARDNER 5"

Needle Holders, Scissors, Micro Surgery Set



DMI-2-2007
MAYO-HEGAR 5"



DMI-2-2008
CRILE 6"



DMI-2-2009
CASTROVIEJO Smooth Jaws 5 1/2"



DMI-2-2010
BOYNTON 5"



DMI-2-2011
MATHIEU 5 1/2"



DMI-2-2012
STEVENS 6 1/2"

Needle Holders, Scissors, Micro Surgery Set



DMI-2-2013
Micro Scissor Straight, 155 mm



DMI-2-2014
Micro Scissor Straight, 150 mm



DMI-2-2015
Needle Holders, Scissors,
Micro Surgery Set

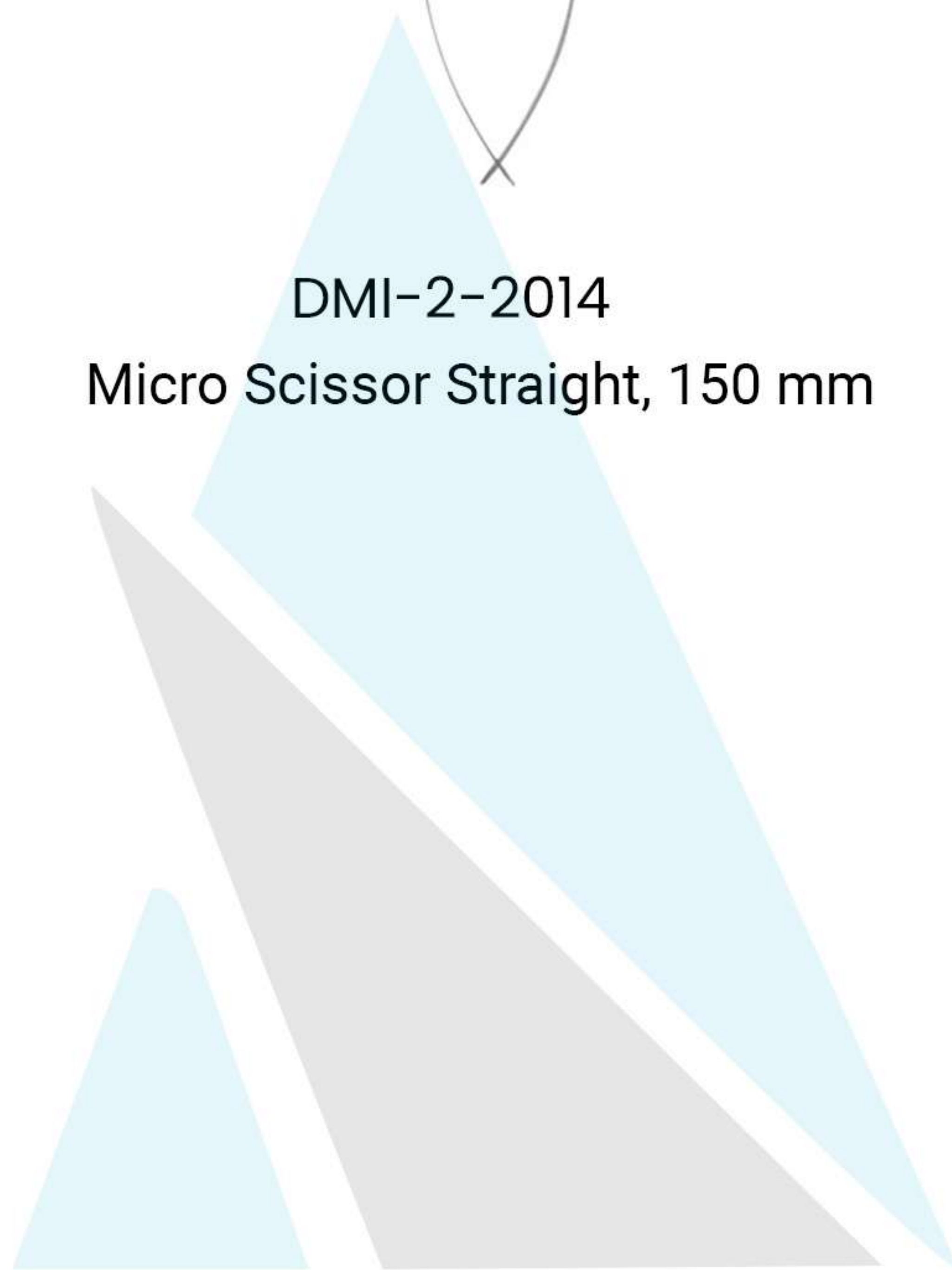

DMI-2-2016
Micro Scissor Curved, 150 mm



DMI-2-2017
CASTROVIEJO T.C. Straight, 180 mm

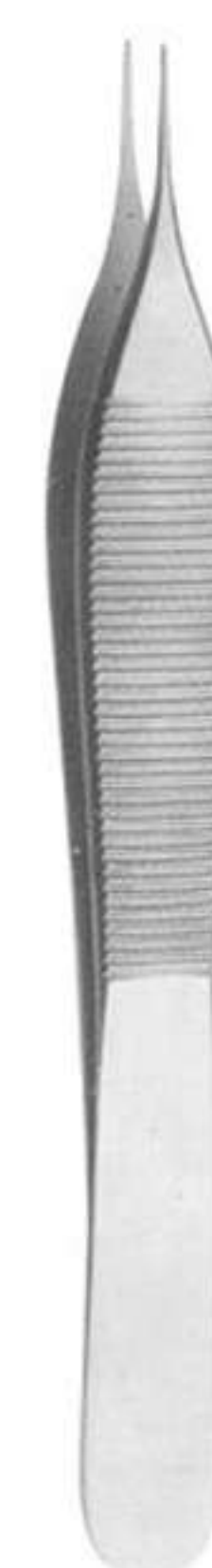

DMI-2-2018
Retractor Fig.3 165 mm

Needle Holders, Scissors, Micro Surgery Set



DMI-2-2019
Micro Adson 120 mm



DMI-2-2020
GERALD Curved, 180 mm



DMI-2-2021
GERALD Straight, 175 mm



DMI-2-2022
Micro Adson 160 mm

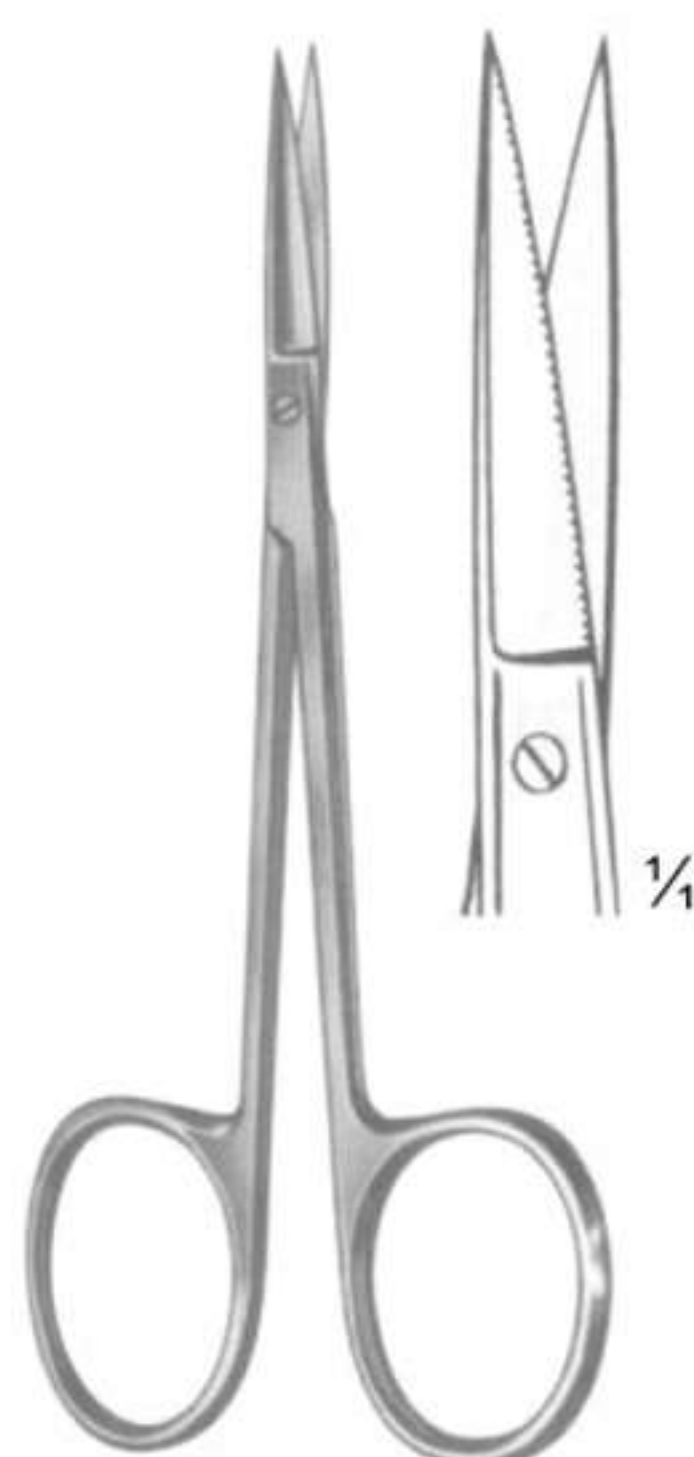

DMI-2-2022
Micro Surgery Set 10 Pieces.

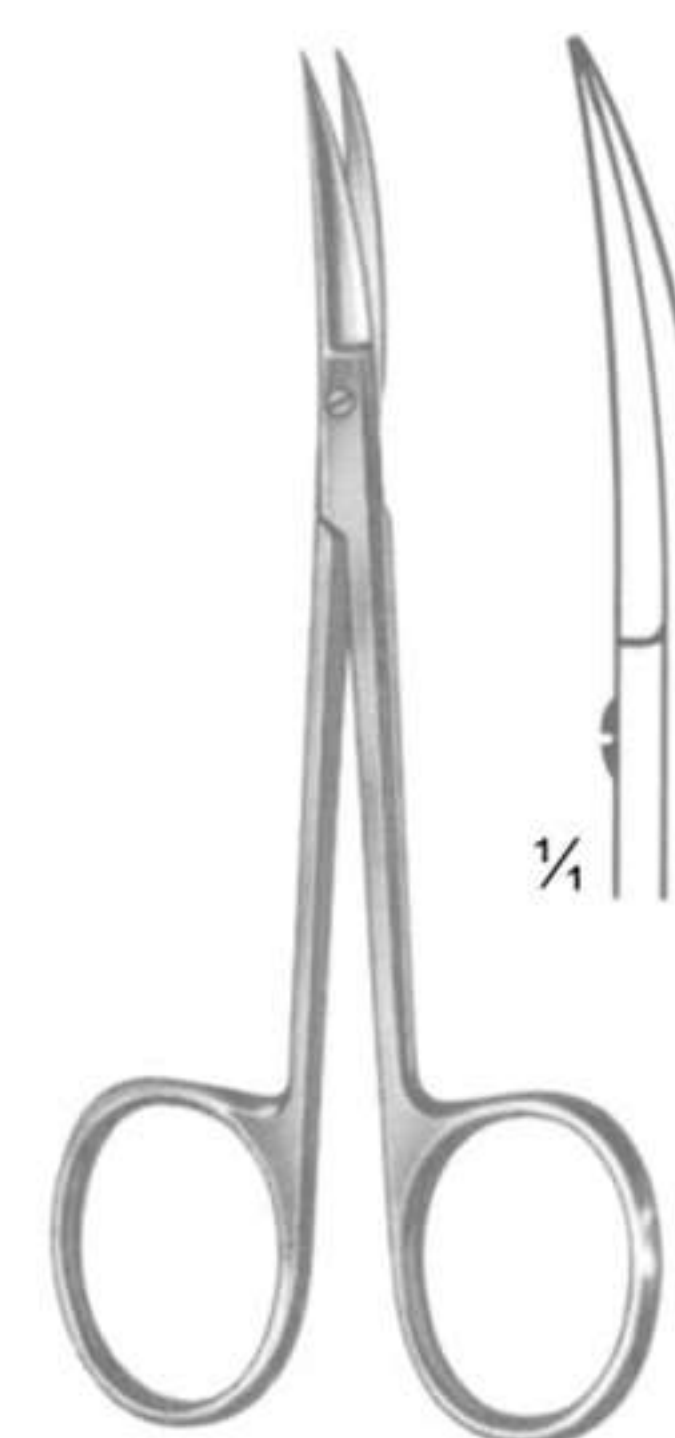

DMI-2-2023
IRIS (Standard) Straight
11.5 cm, 4 1/2"



DMI-2-2024
Micro Adson 120 mm

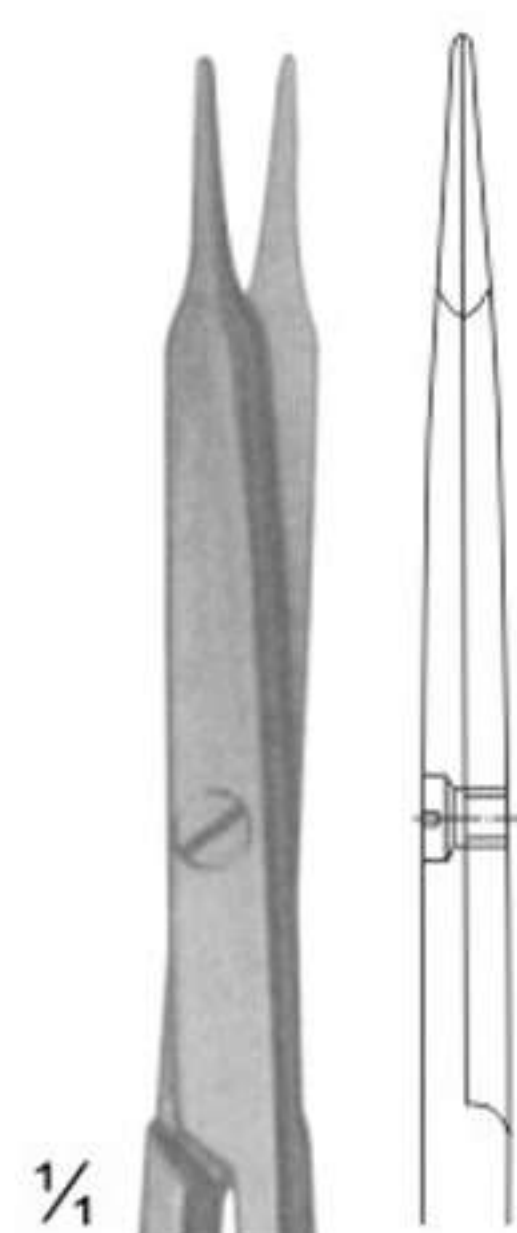

DMI-2-2025
STEVENS Dissecting Scissors
Size: 115 mm

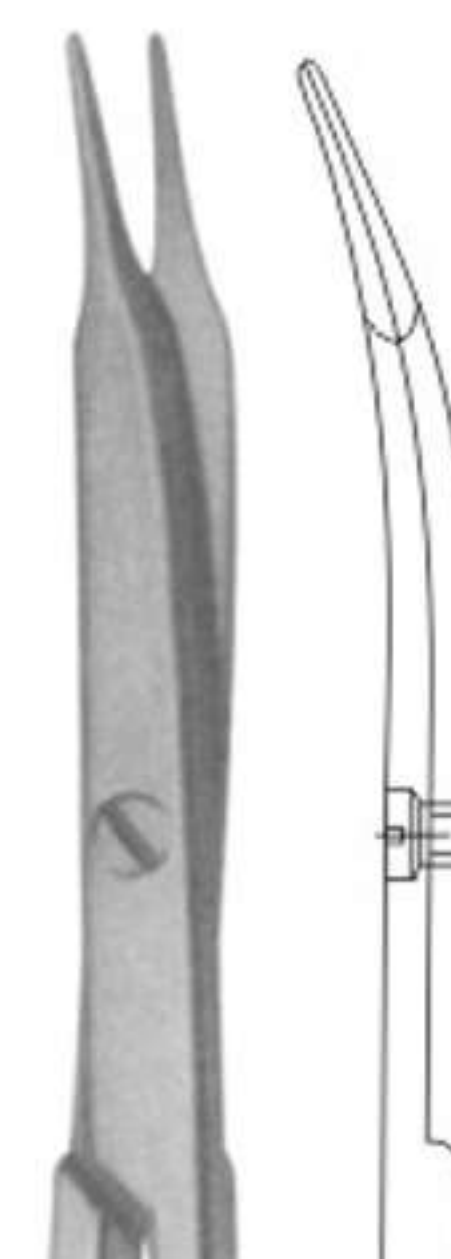

DMI-2-2026
Sharp

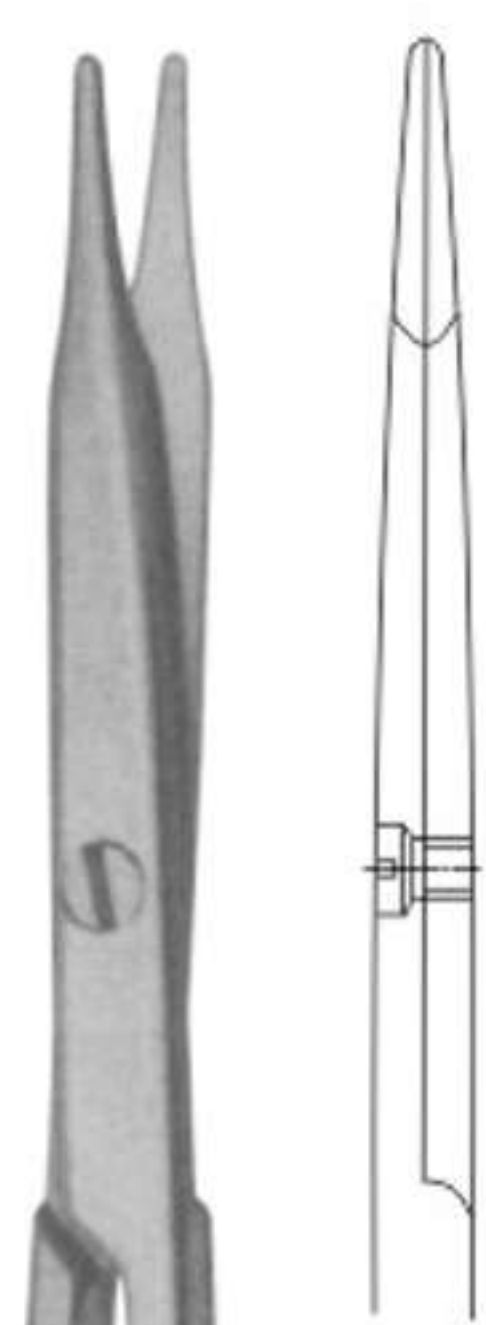
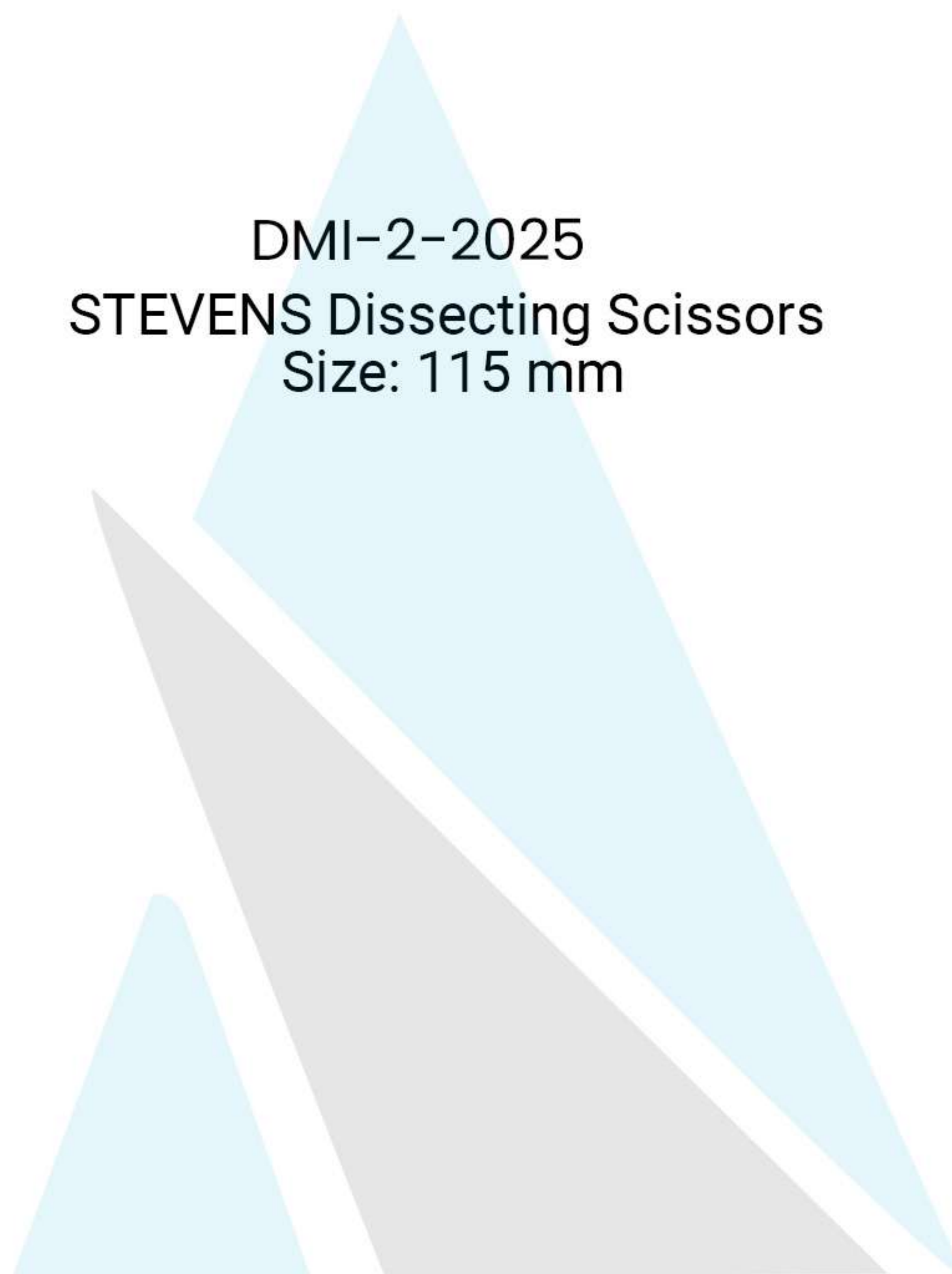

DMI-2-2027
Sharp

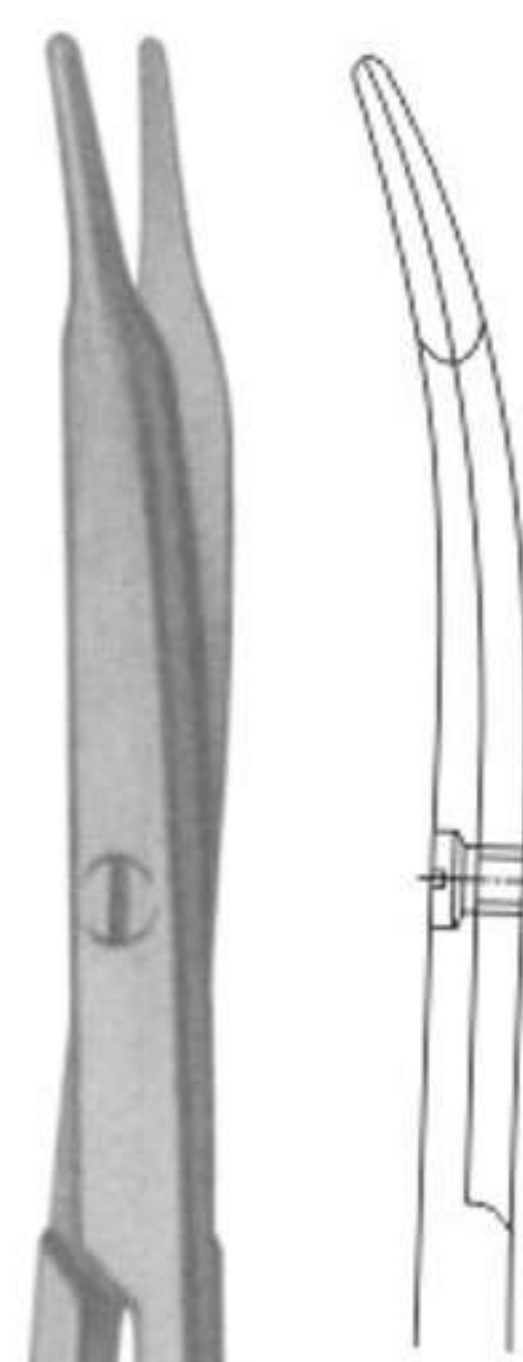

DMI-2-2028
Blunt

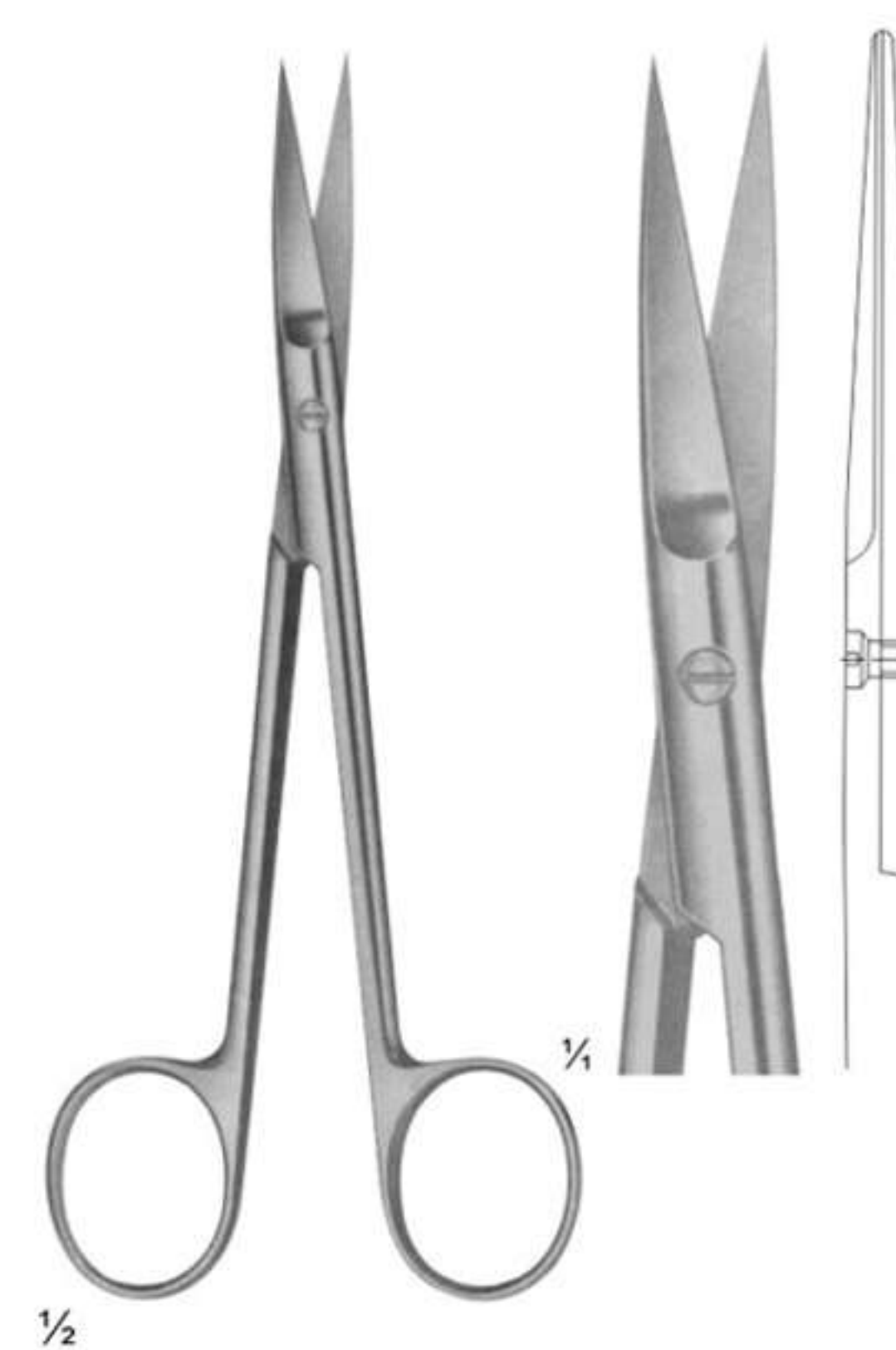

DMI-2-2029
Blunt

Needle Holders, Scissors, Micro Surgery Set

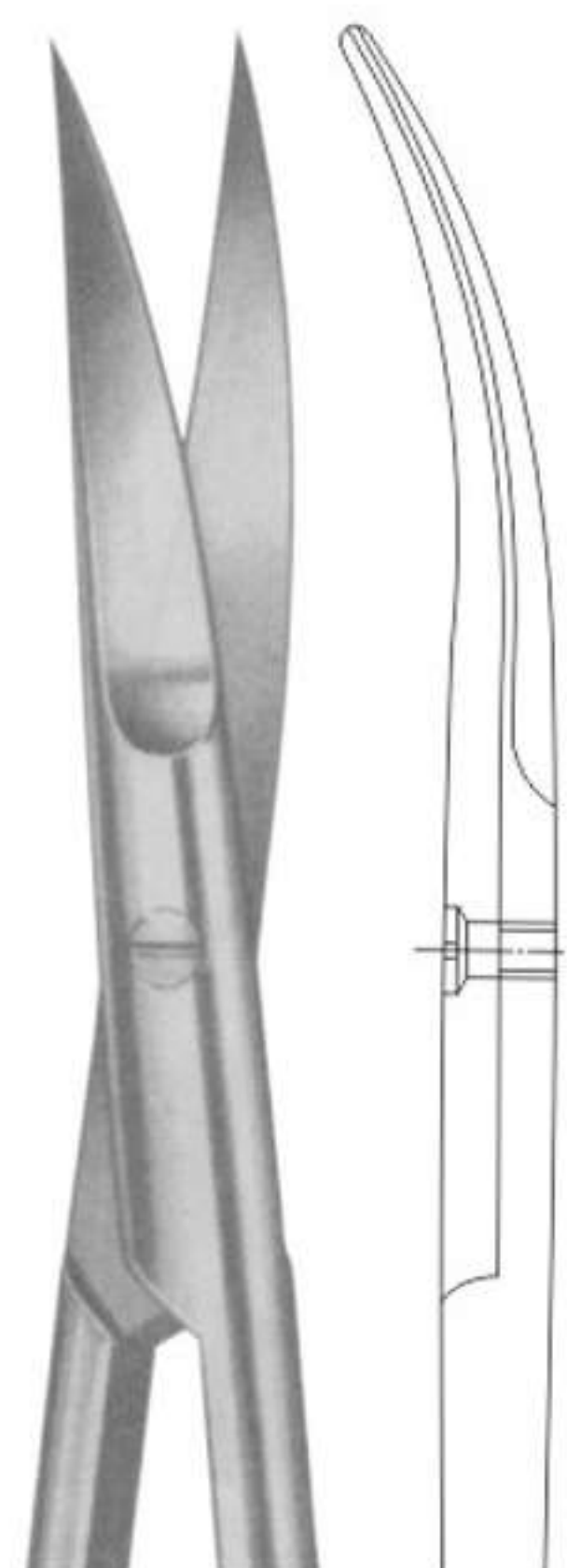

DMI-2-2030
Needle Holders, Scissors,
Micro Surgery Set

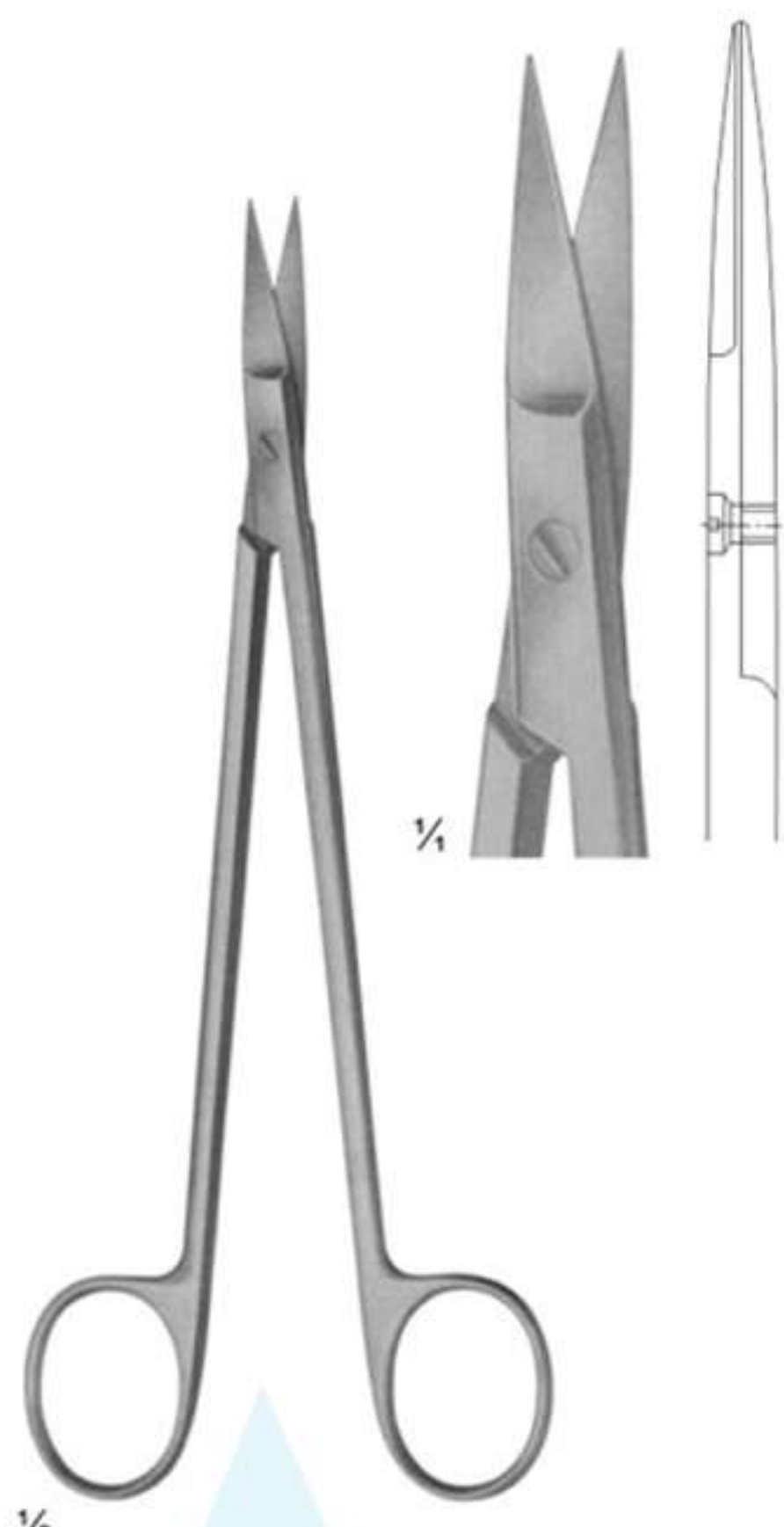

DMI-2-2031
Needle Holders, Scissors,
Micro Surgery Set

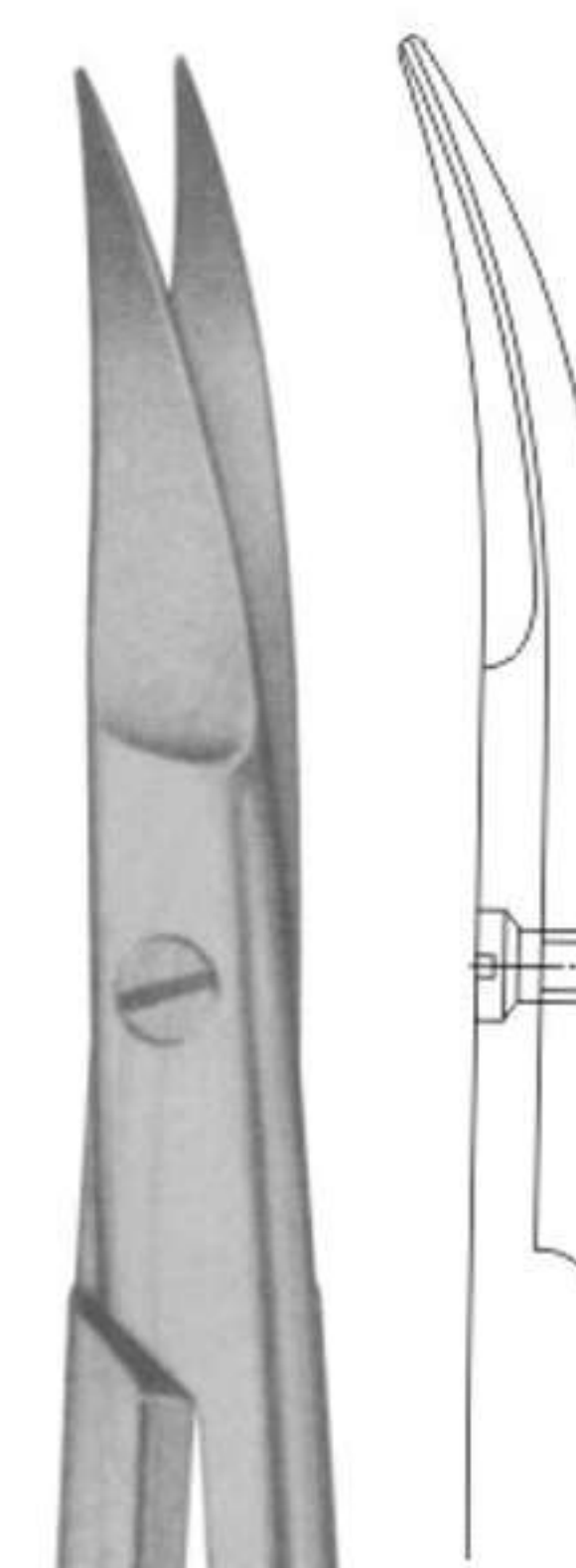

DMI-2-2032
KELLY Size: 175 mm



DMI-2-2022
Needle Holders, Scissors,
Micro Surgery Set



DMI-2-2034
Needle Holders, Scissors,
Micro Surgery Set

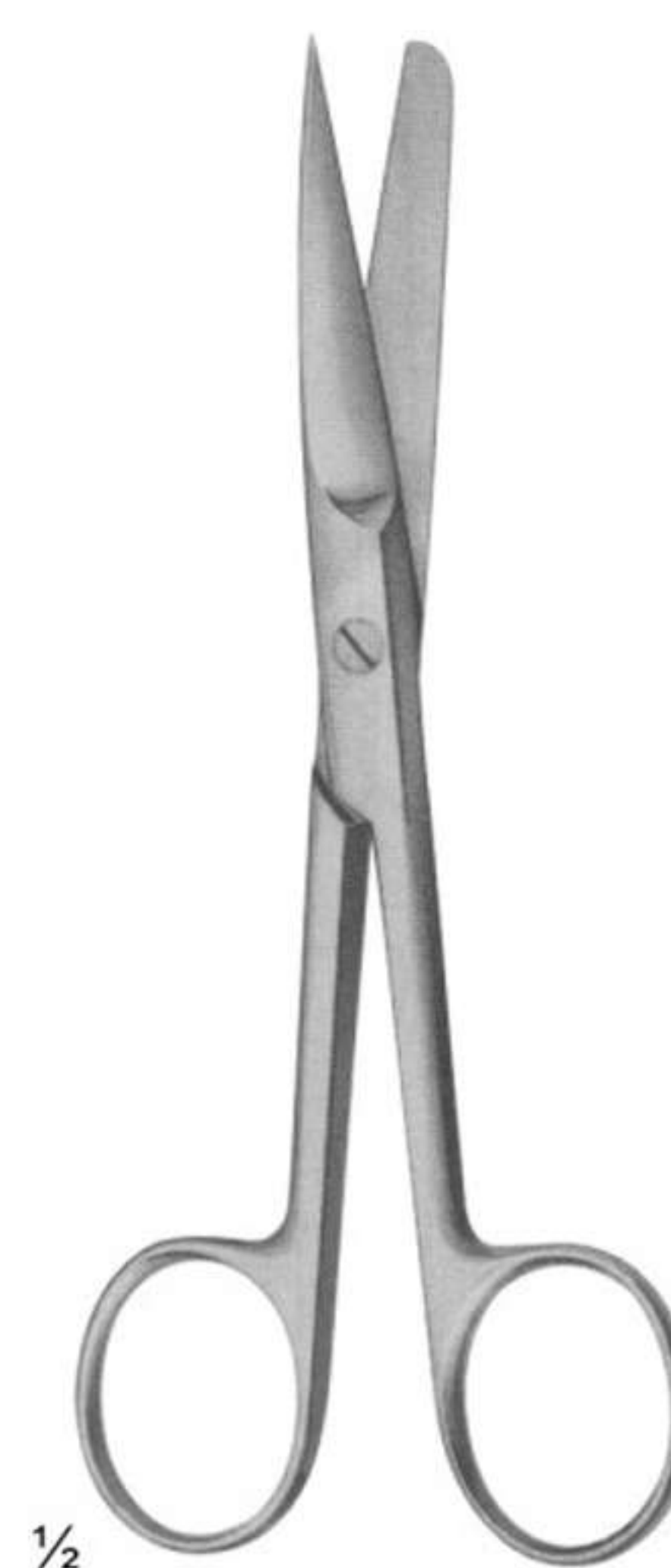

DMI-2-2035
QUINBY Size: 130 mm

Needle Holders, Scissors, Micro Surgery Set

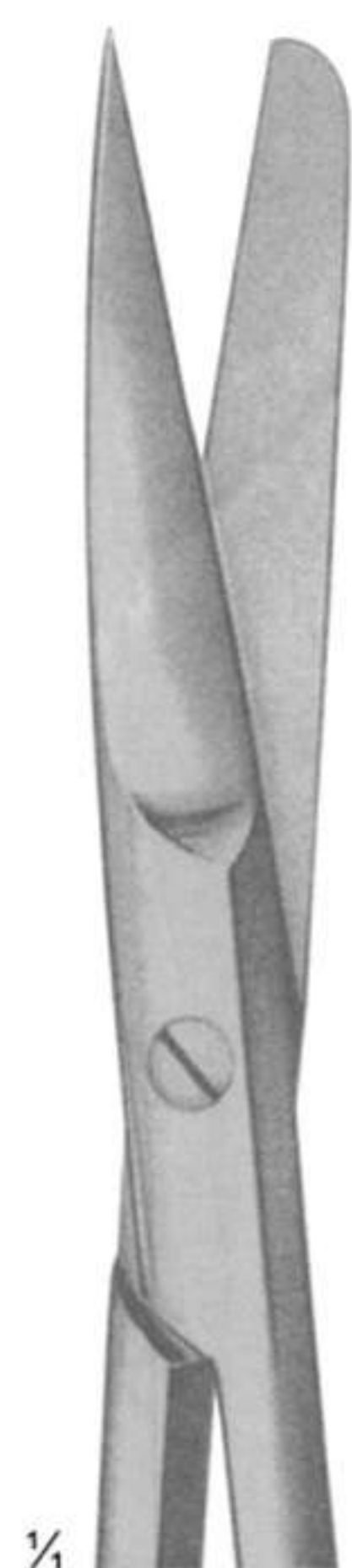

DMI-2-2036
Standard - Types Size: 115 mm

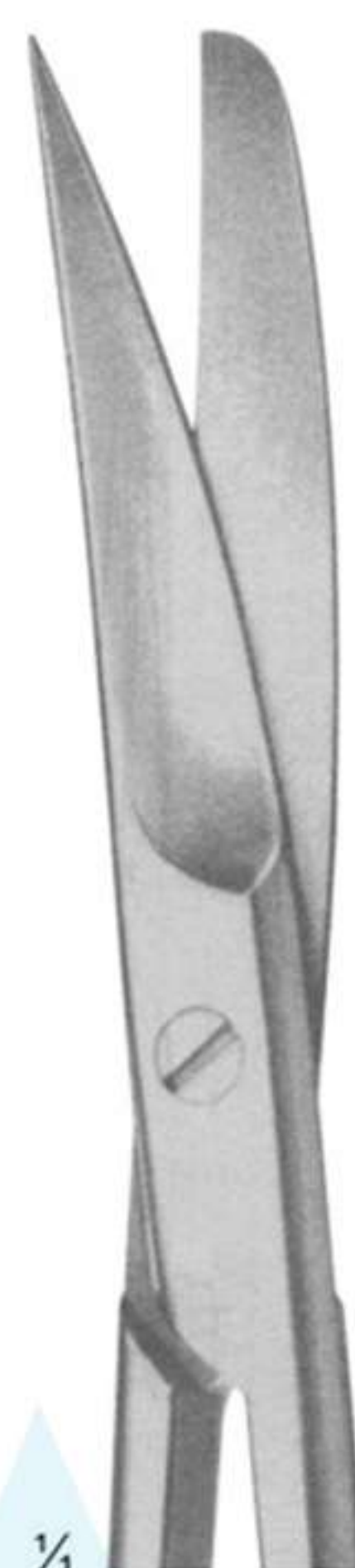

DMI-2-2037
DEAVER With flat lock

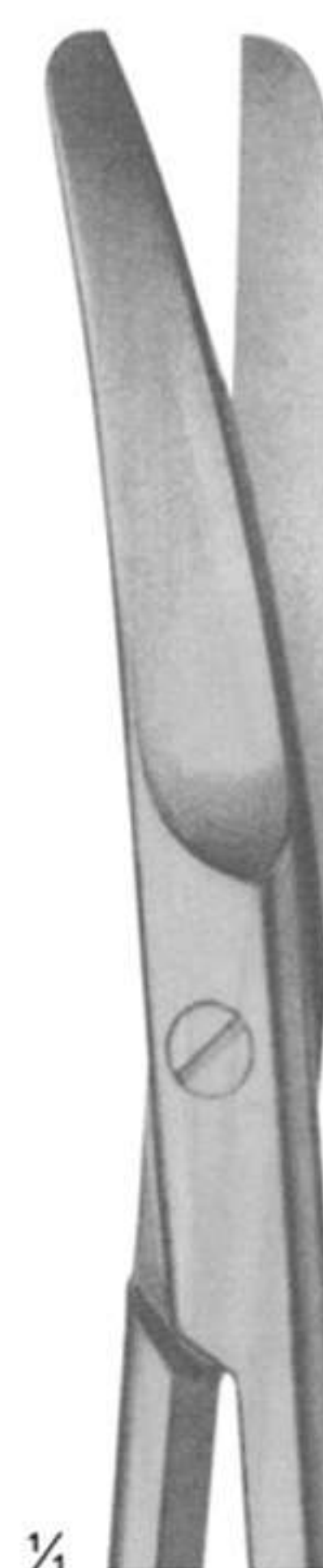

DMI-2-2038
Size: 145 mm

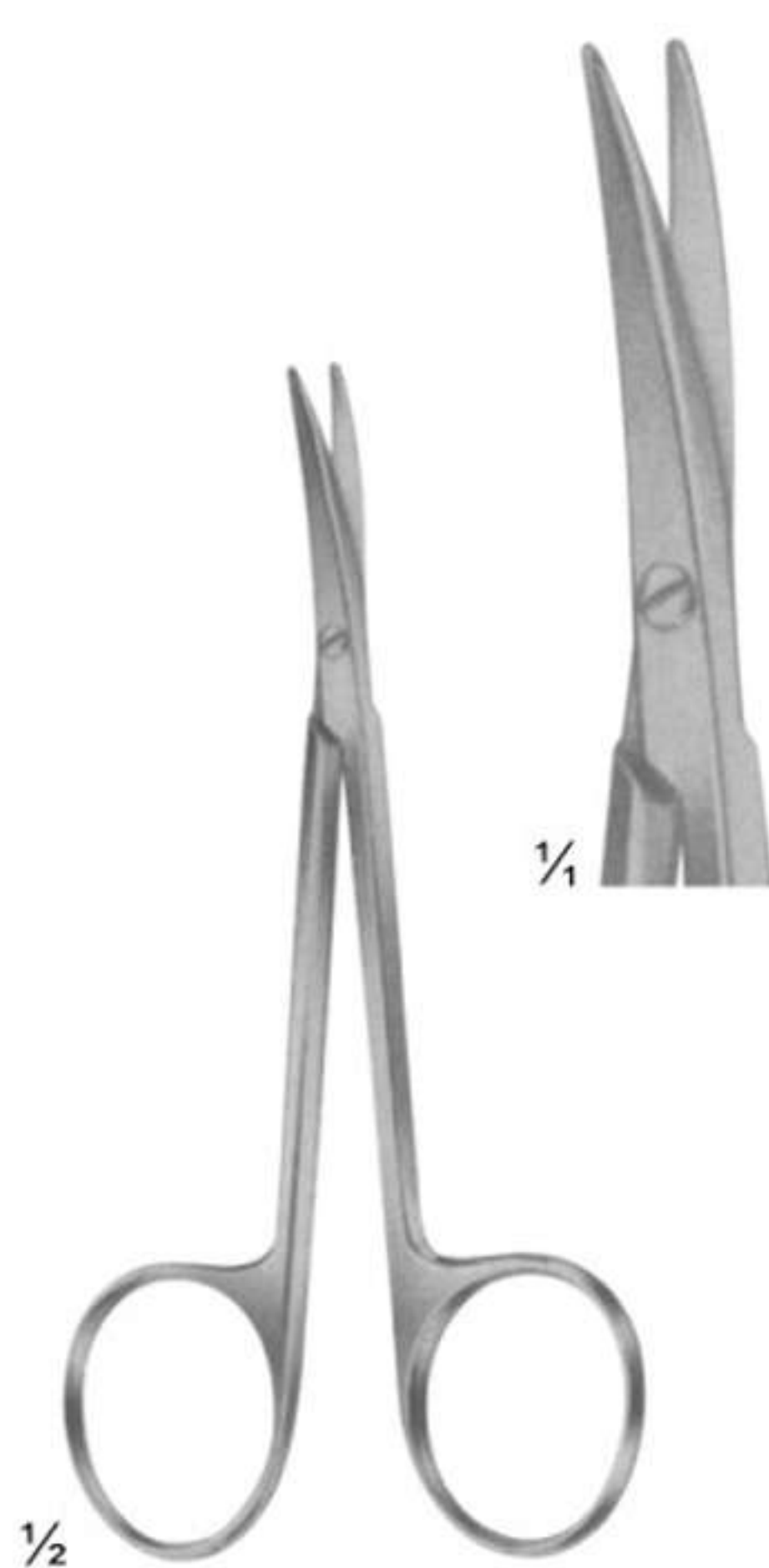

DMI-2-2039
Size: 145 mm

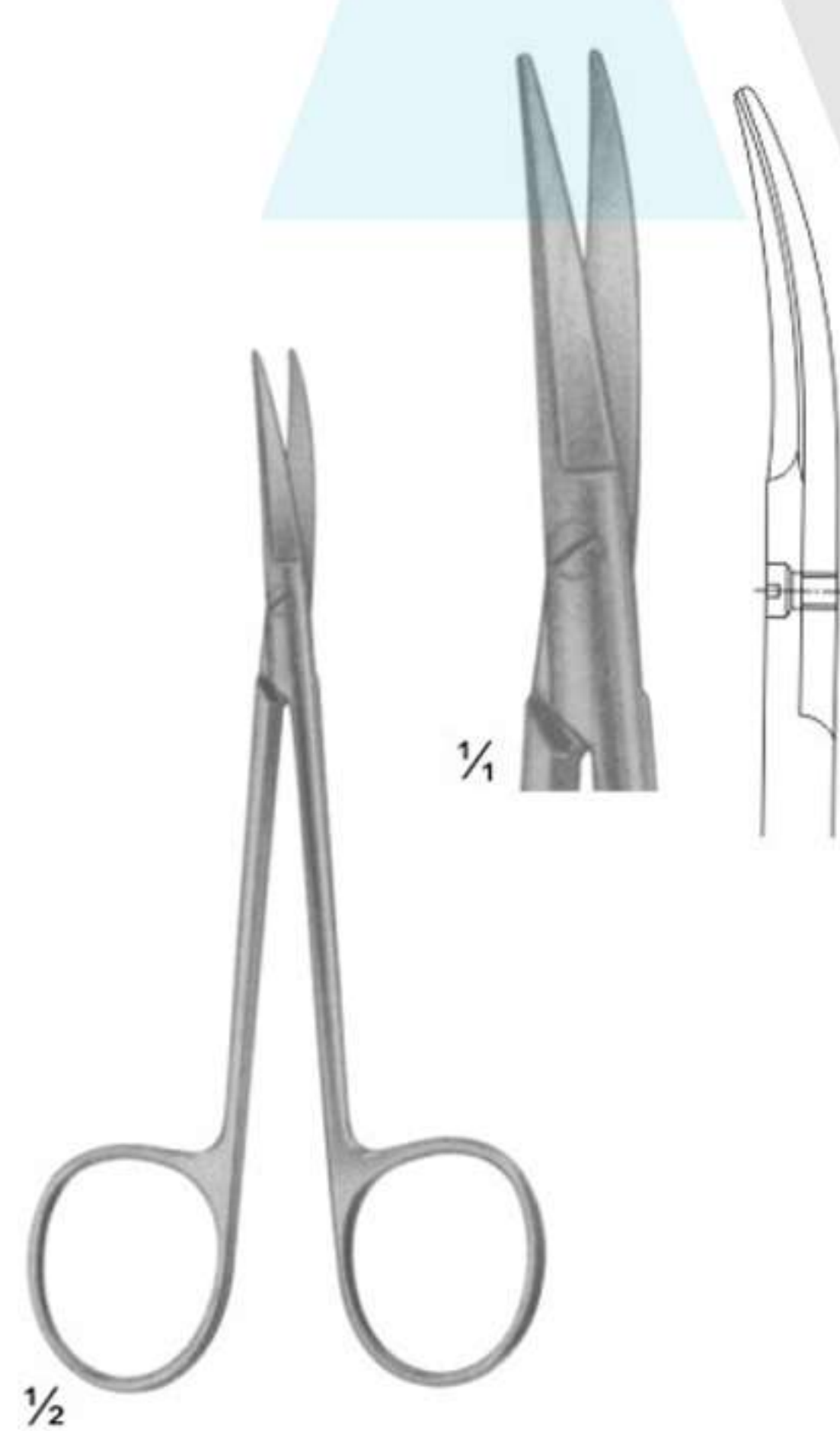

DMI-2-2040
Size: 145 mm

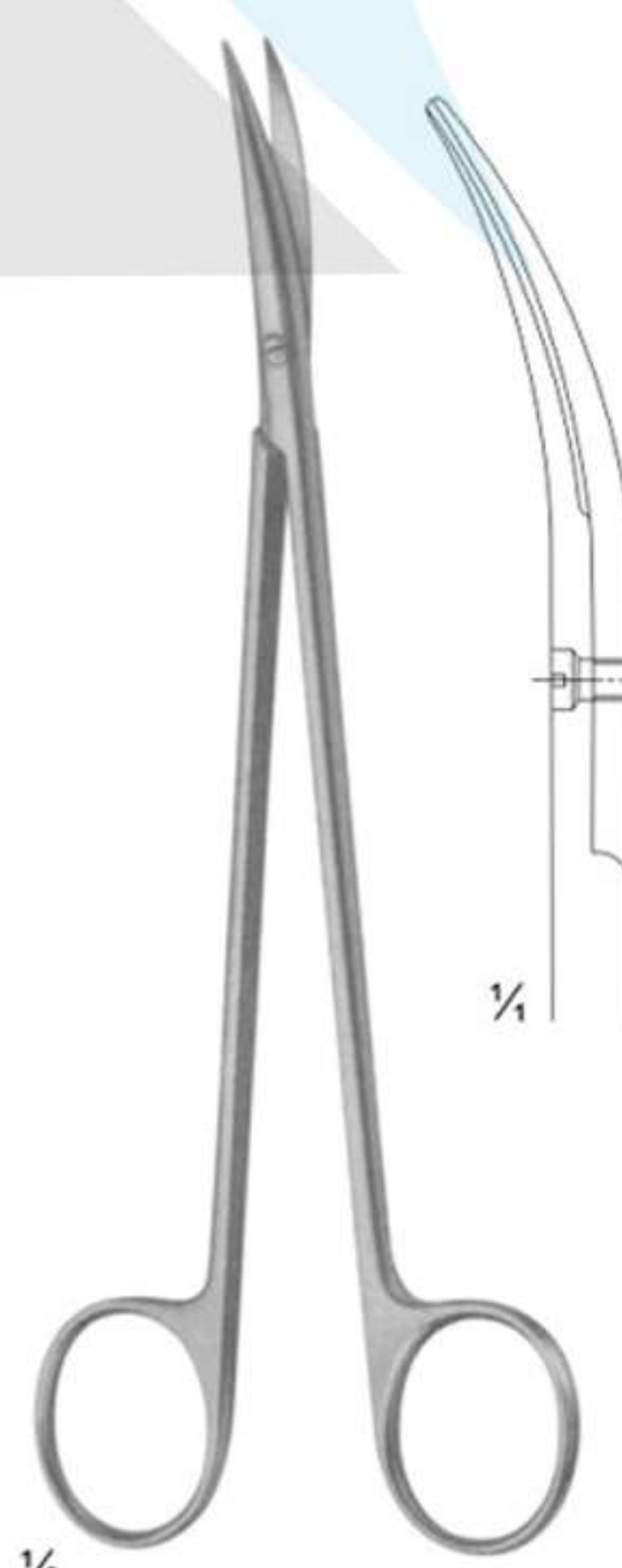

DMI-2-2041
LITTLER Dissecting Scissors
Size: 115 mm

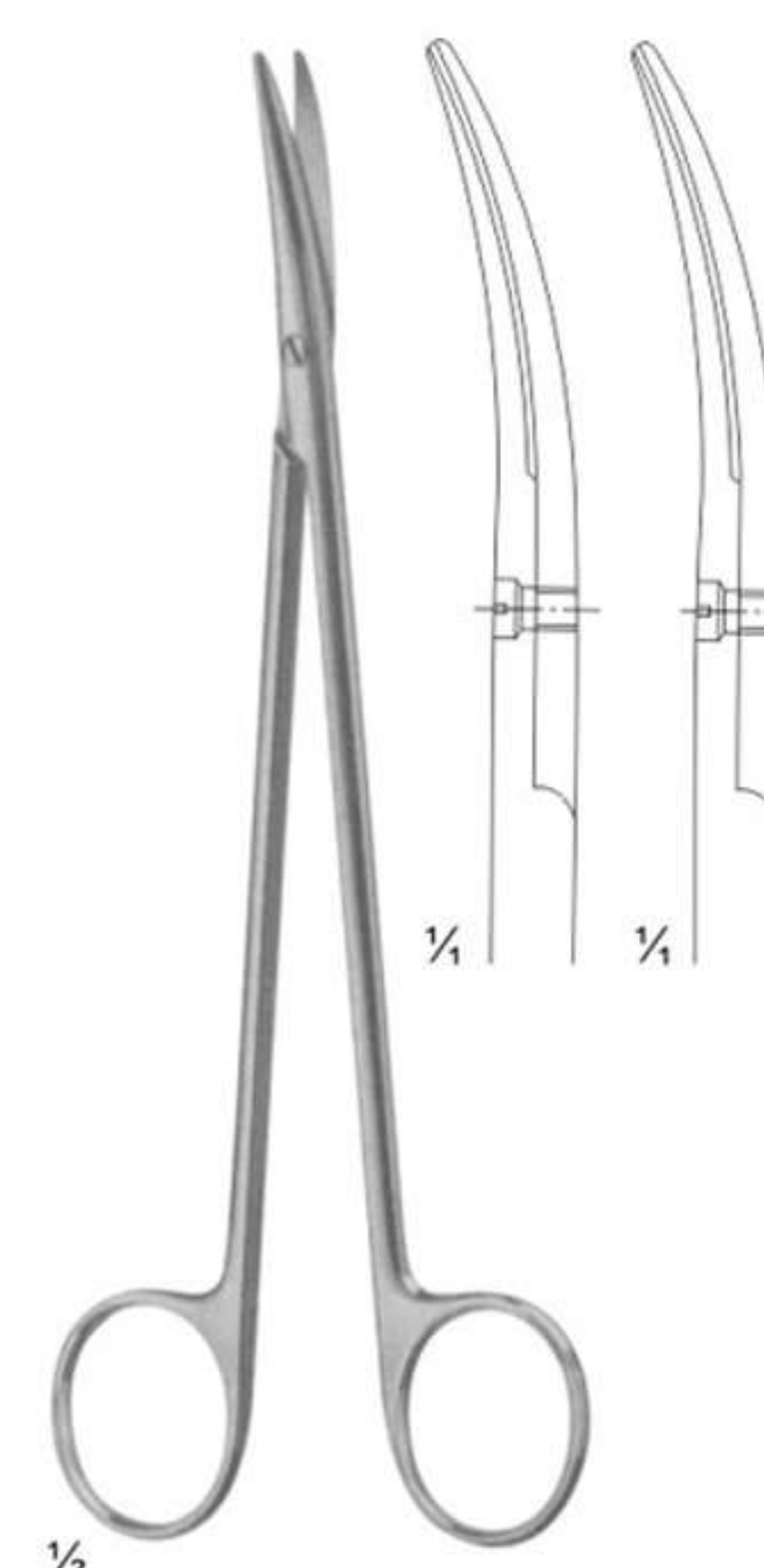

DMI-2-2042
COTTLE Bulldog Scissors
Size: 115 mm

Impression Trays



DMI-2-2101
Impression Trays



DMI-2-2102
Impression Trays

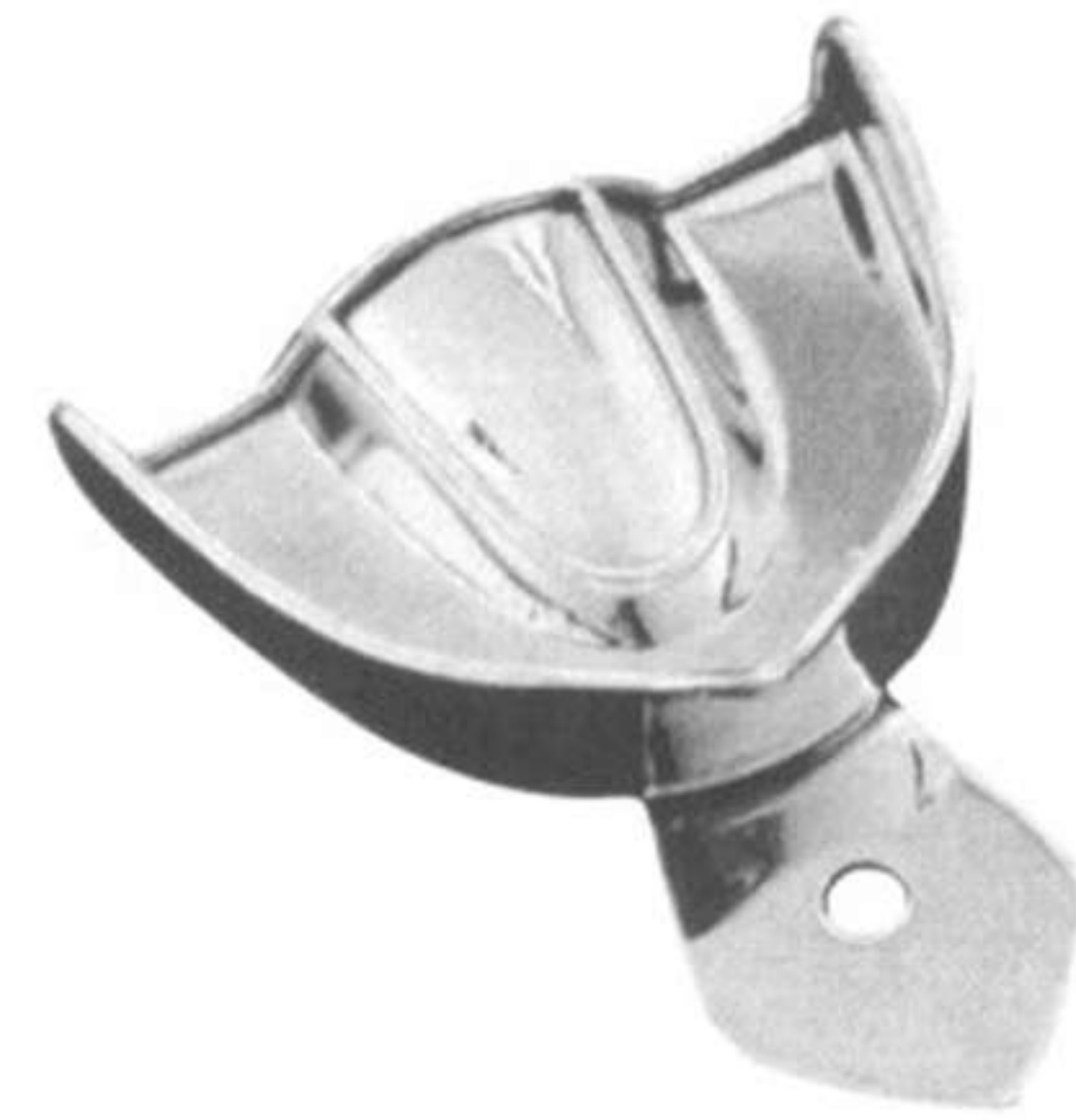

DMI-2-2103
Impression Trays

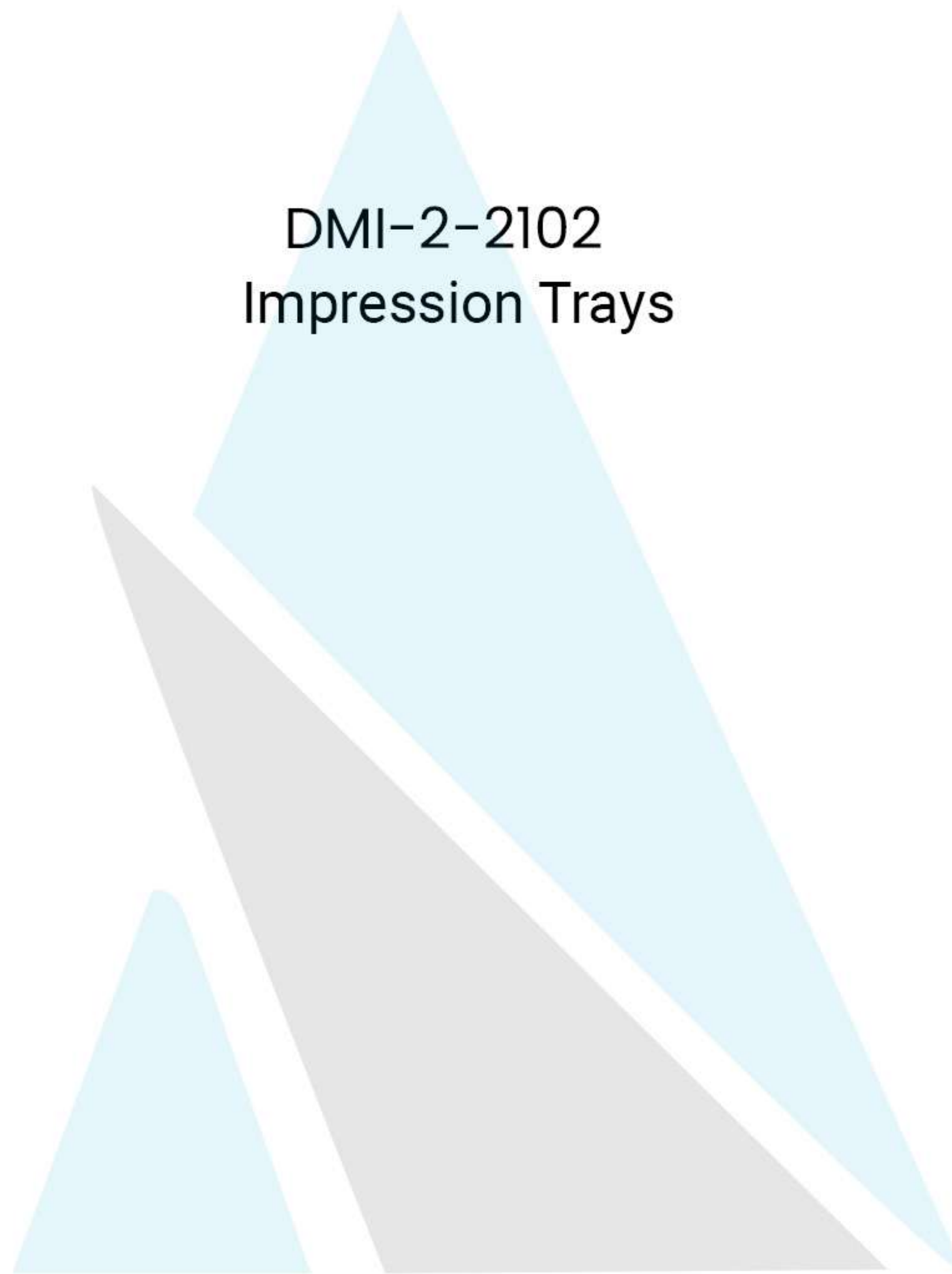

DMI-2-2104
Impression Trays



DMI-2-2105
U5



DMI-2-2106

Impression Trays



DMI-2-2107
L2



DMI-2-2108
L3



DMI-2-2109
L4

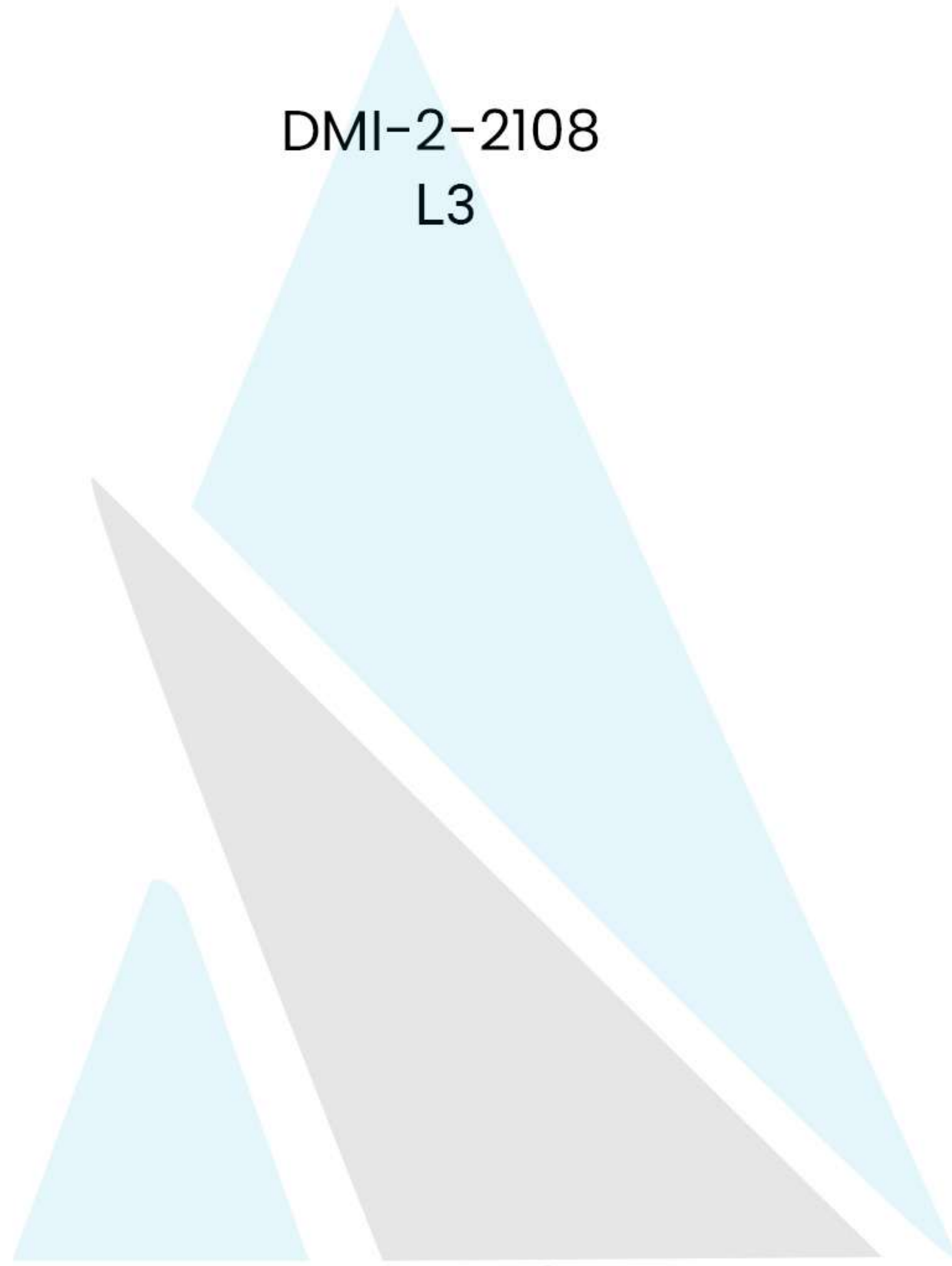

DMI-2-2110
L5



DMI-2-2111
U1



DMI-2-2112
U2

Impression Trays



DMI-2-2113
U3



DMI-2-2114
U4



DMI-2-2115
L1

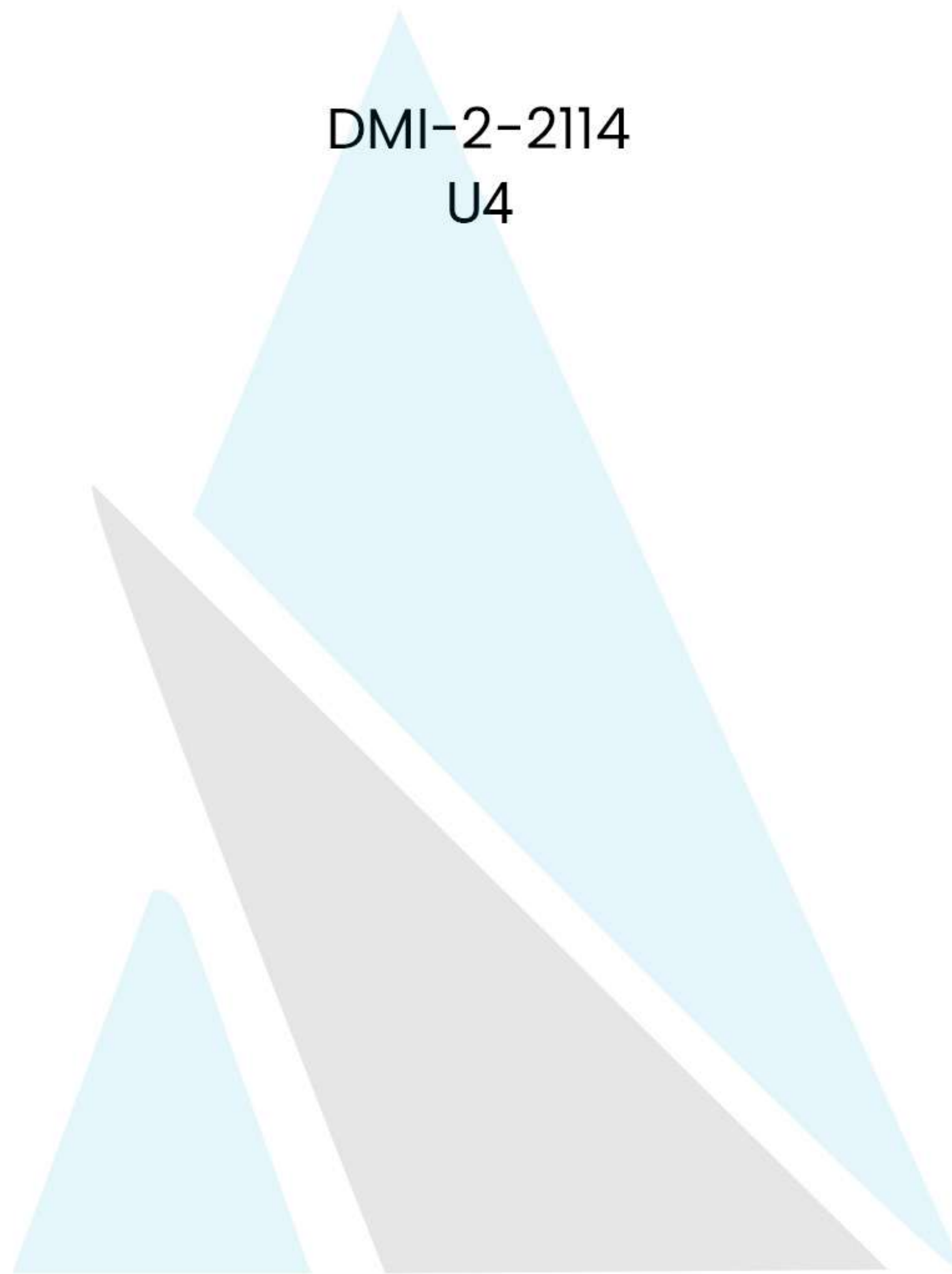

DMI-2-2116



DMI-2-2117
L3



DMI-2-2118
L4

Impression Trays



DMI-2-2119
L5



DMI-2-2120
XL



DMI-2-2121
L

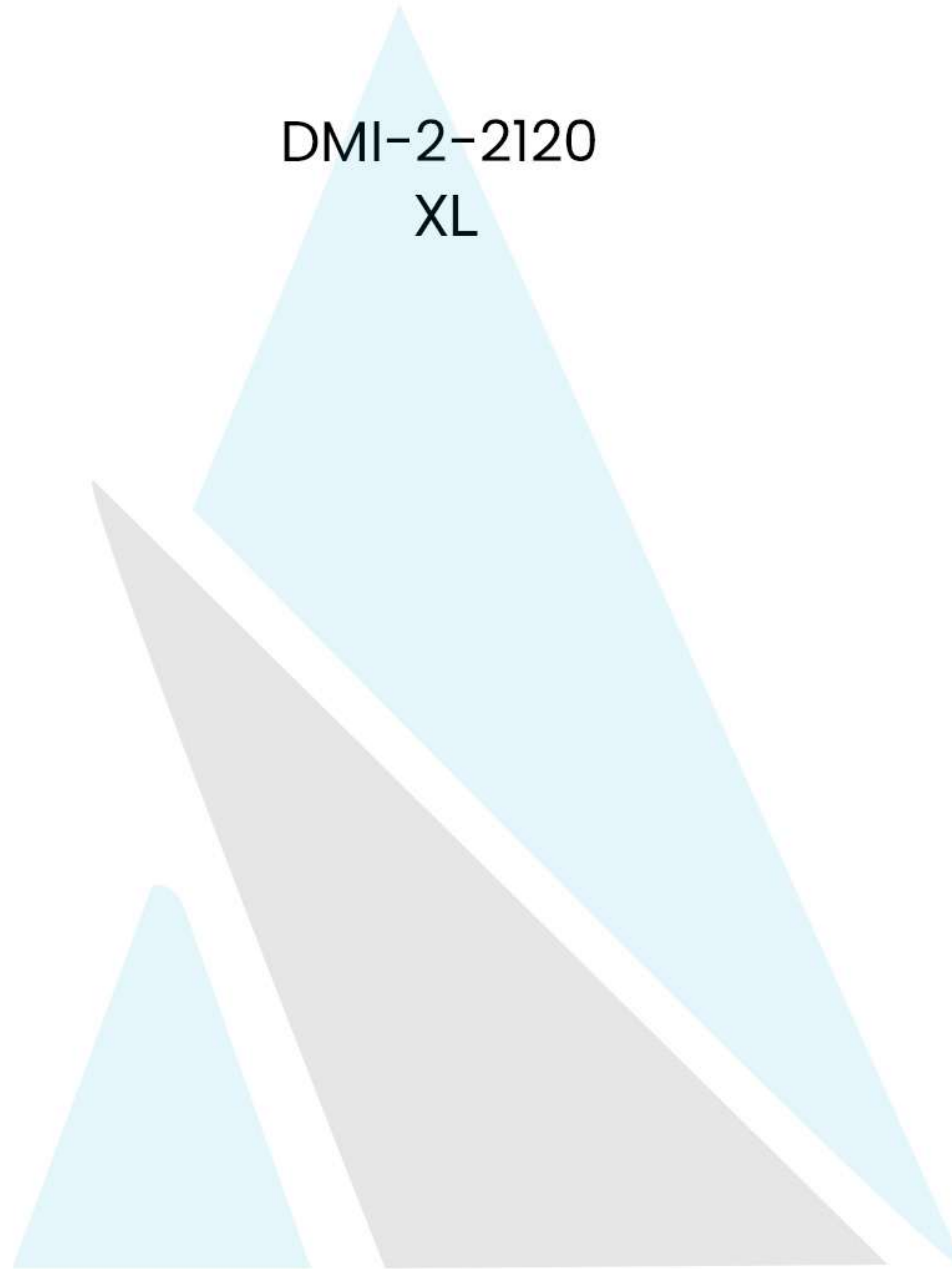

DMI-2-2122



DMI-2-2123
S



DMI-2-2124
XL

Impression Trays



DMI-2-2125
L



DMI-2-2126
M



DMI-2-2127
S

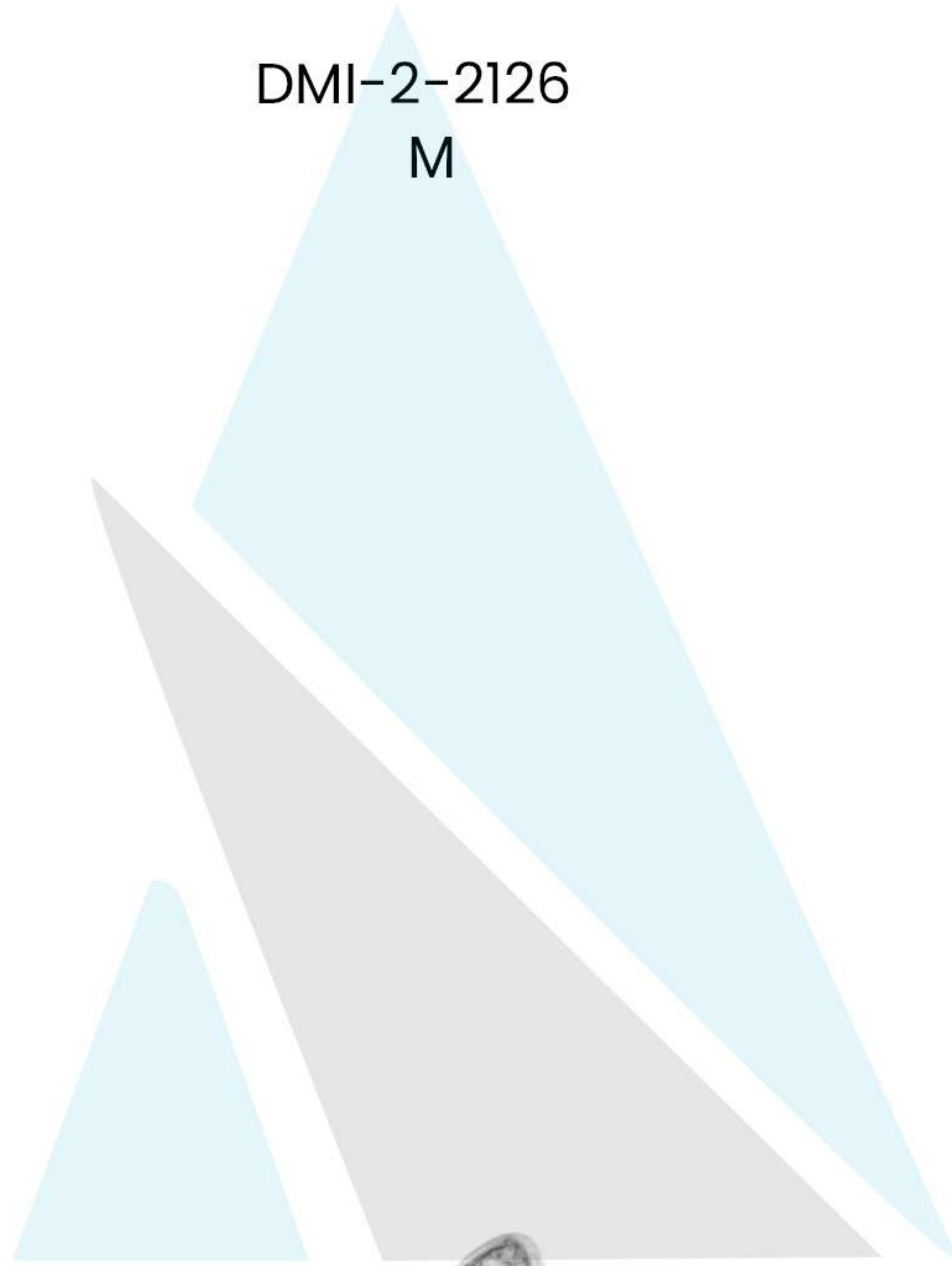

DMI-2-2128
XL



DMI-2-2129
L



DMI-2-2130

Impression Trays



DMI-2-2131
S



DMI-2-2132
XL



DMI-2-2133
L

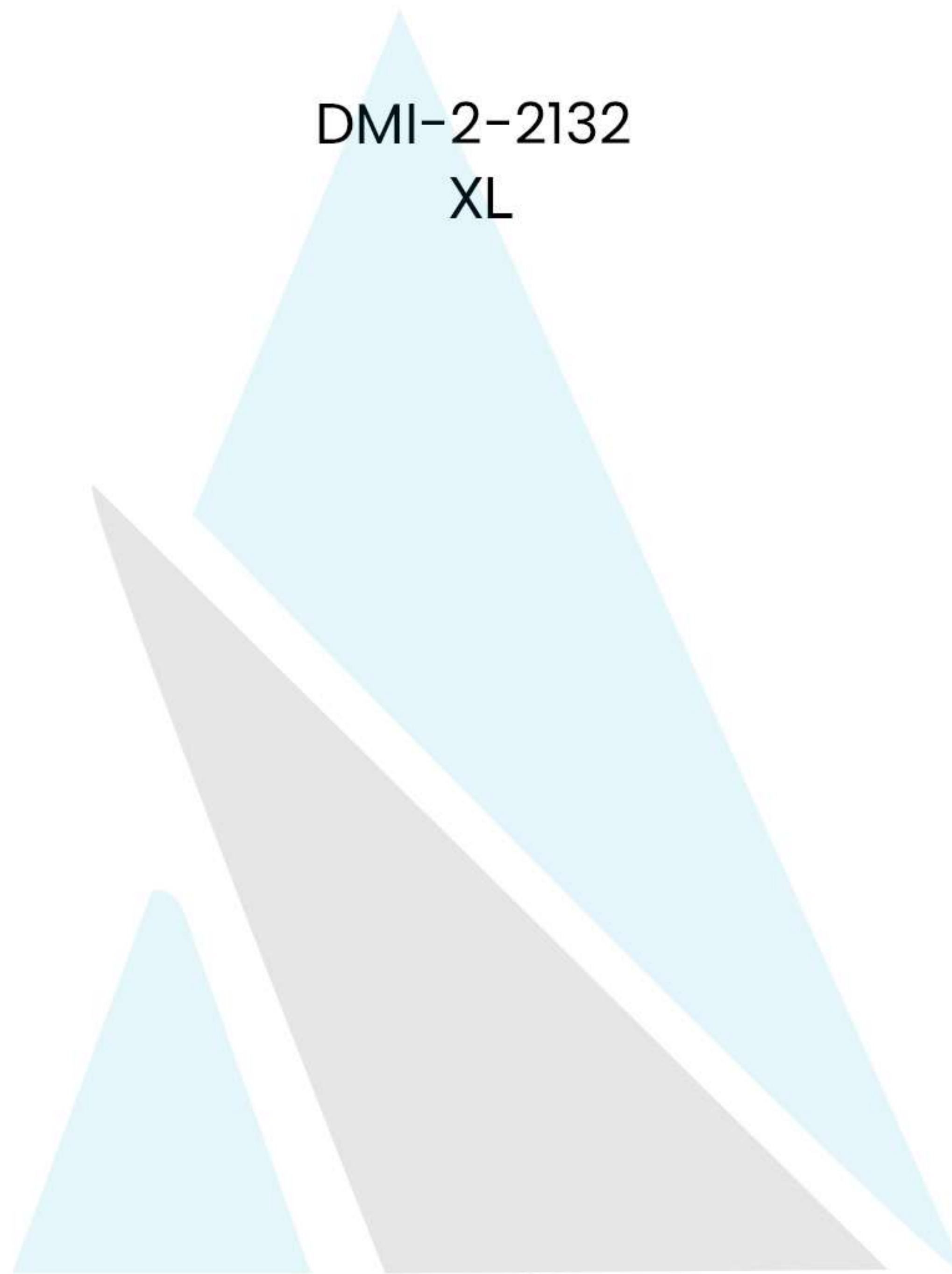

DMI-2-2134
M



DMI-2-2135
S



DMI-2-2136
U1

Impression Trays



DMI-2-2137
U2



DMI-2-2138
U3



DMI-2-2139
L1

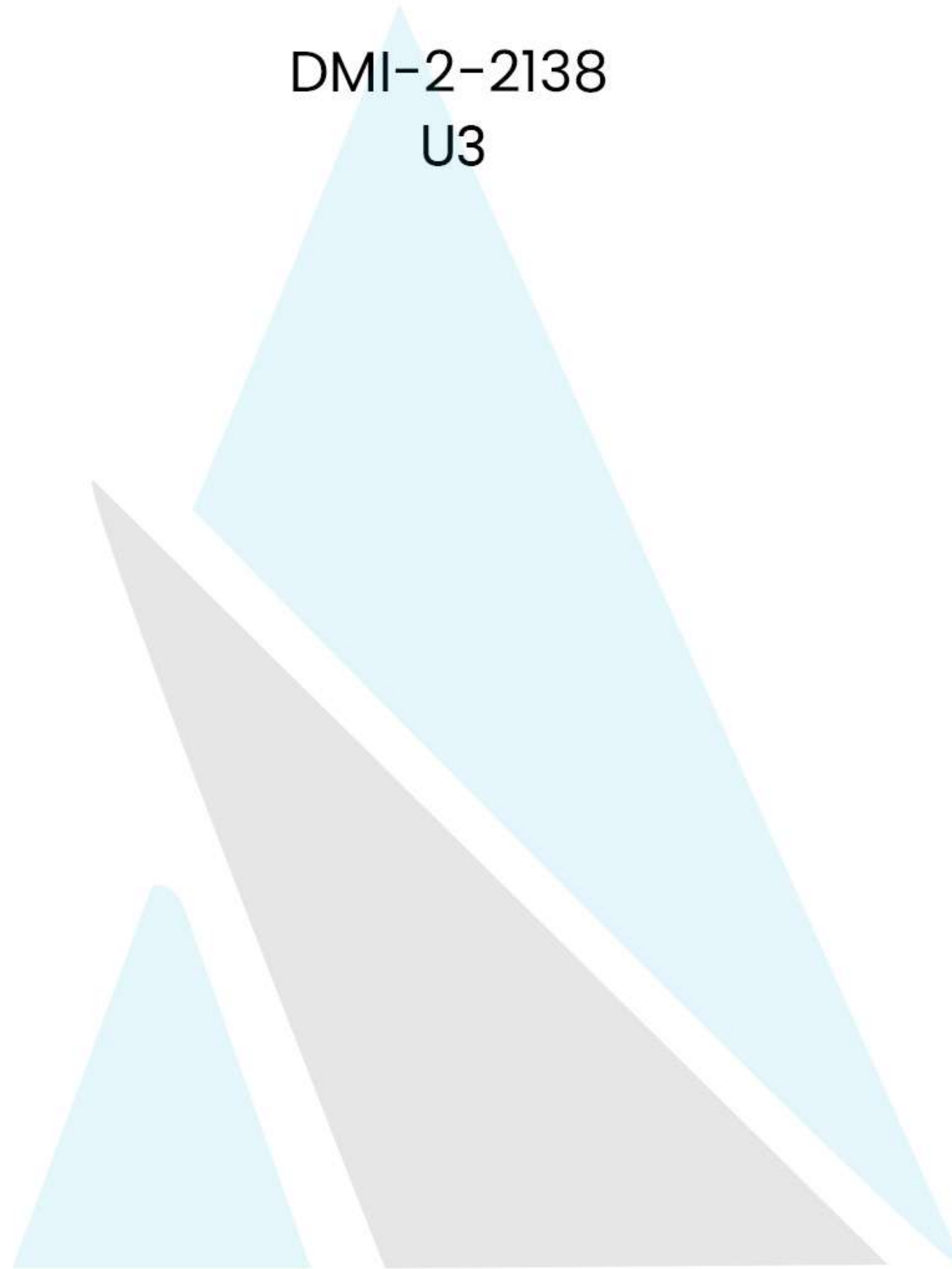

DMI-2-2140
L2



DMI-2-2141
L3



DMI-2-2142
U1

Impression Trays



DMI-2-2143
U2



DMI-2-2144
U3



DMI-2-2201
Articulators, Hollow Wares



DMI-2-2202
Articulators, Hollow Wares



DMI-2-2203
Articulators, Hollow Wares

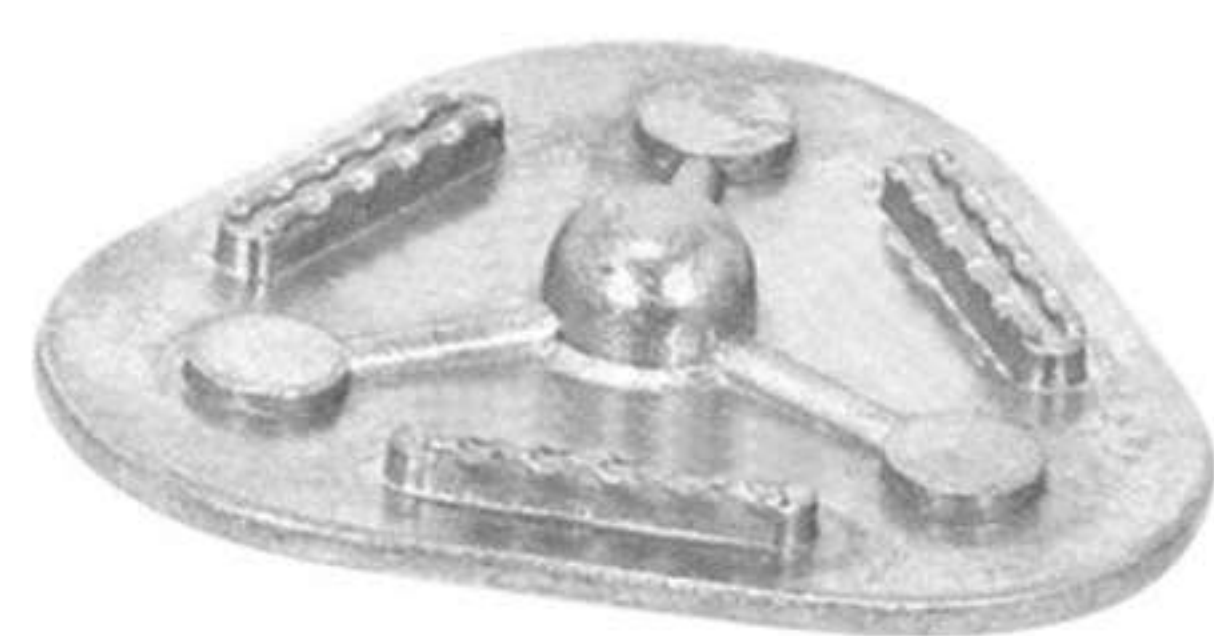

DMI-2-2204
Articulators, Hollow Wares

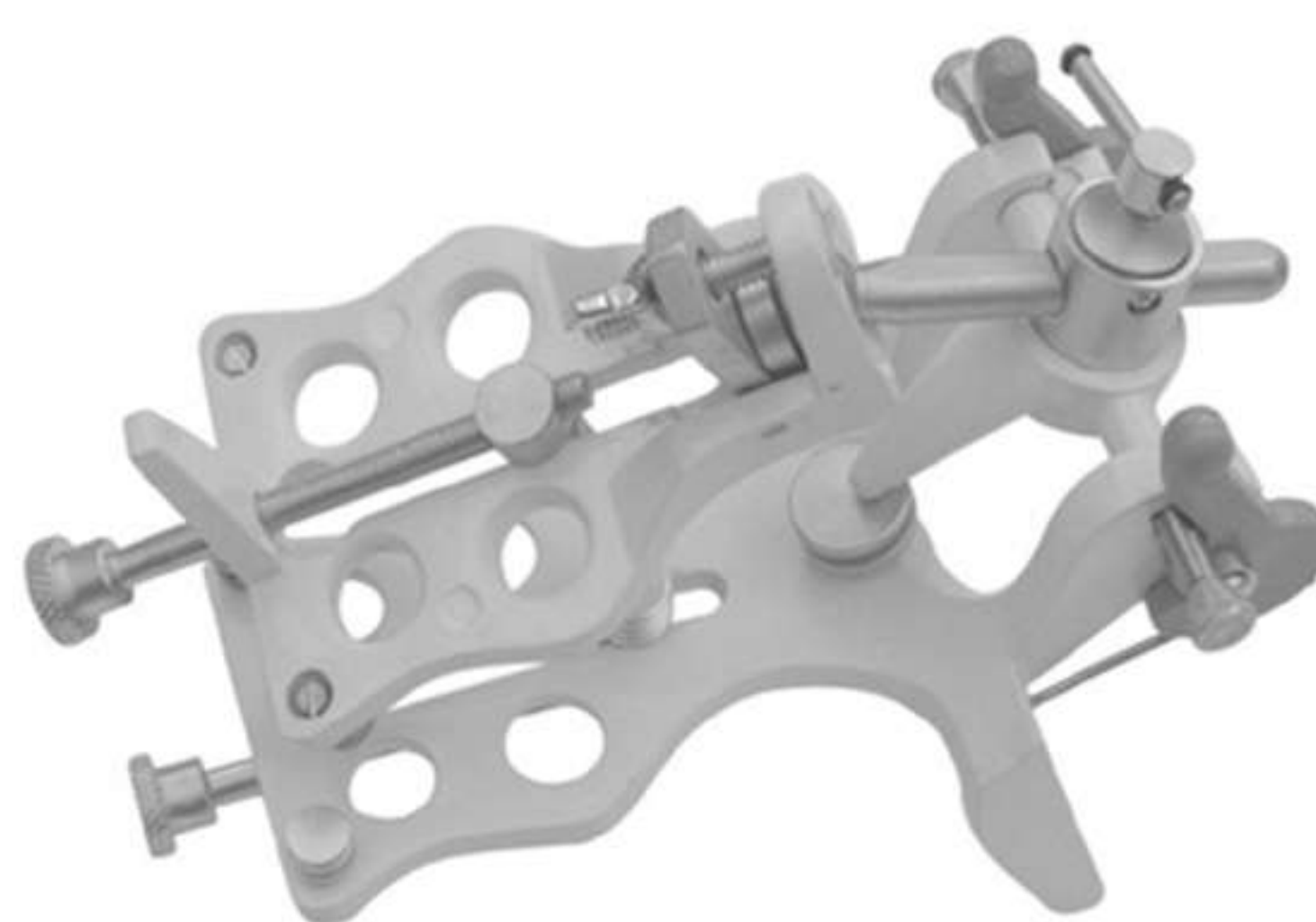

DMI-2-2205
Articulators, Hollow Wares



DMI-2-2206
Articulators, Hollow Wares

Articulators, Hollow Wares



DMI-2-2207
Articulators, Hollow Wares



DMI-2-2208
Articulators, Hollow Wares

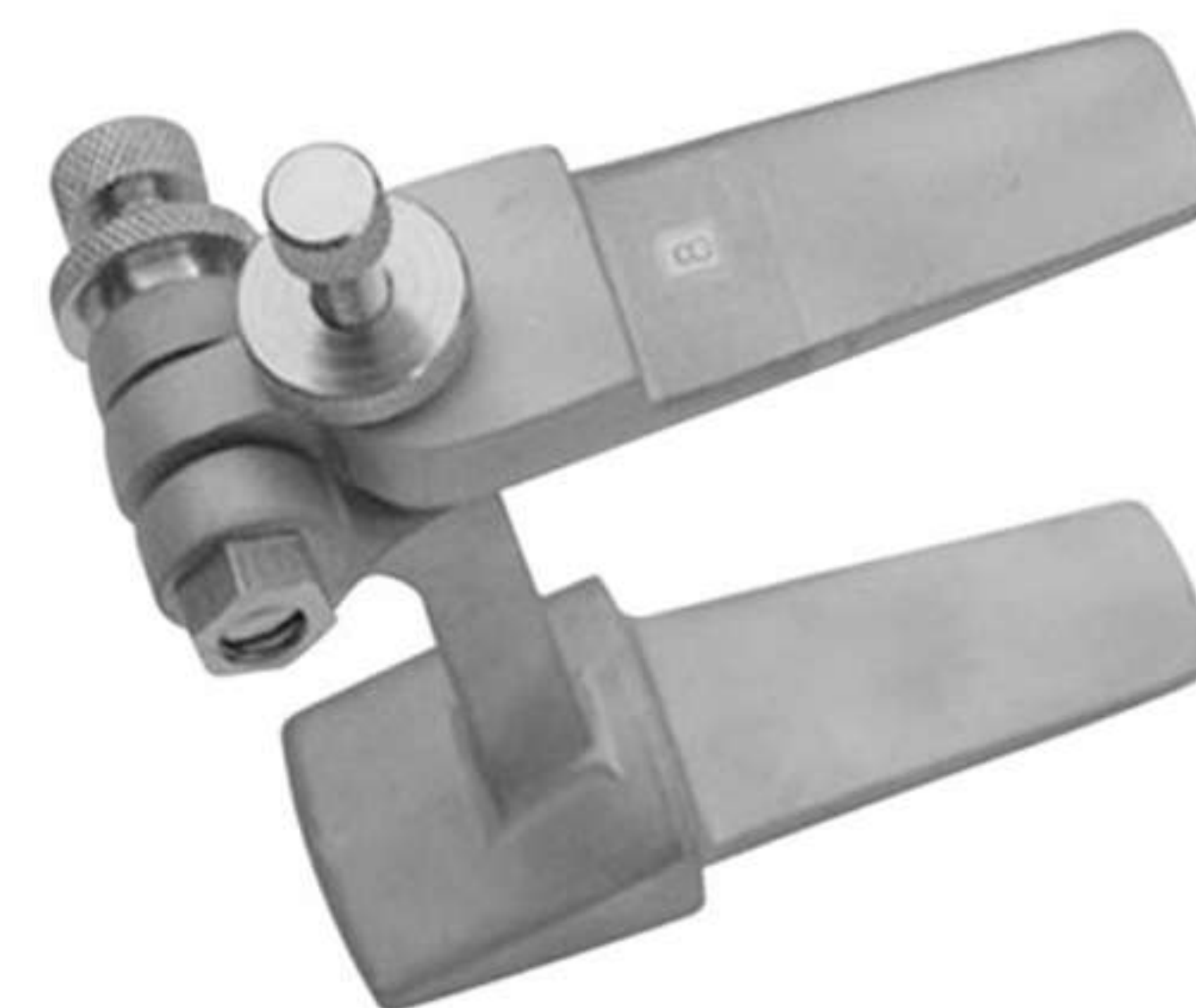

DMI-2-2209
Articulators, Hollow Wares

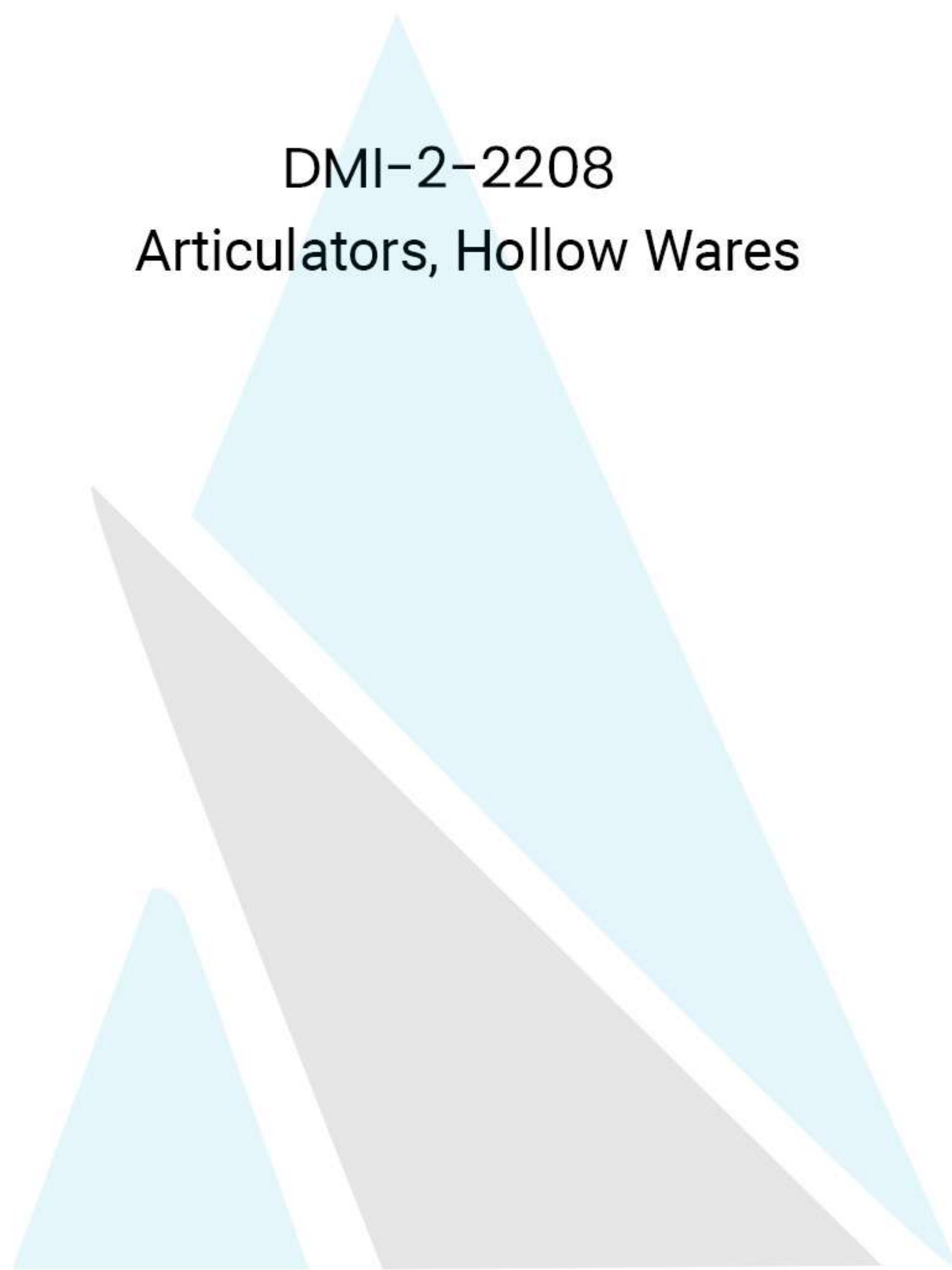

DMI-2-2210
Articulators, Hollow Wares



DMI-2-2211
Articulators, Hollow Wares



DMI-2-2212
Articulators, Hollow Wares



DMI-2-2213
Instruments Tray



DMI-2-2214
Instruments Tray



DMI-2-2215
Instruments Tray

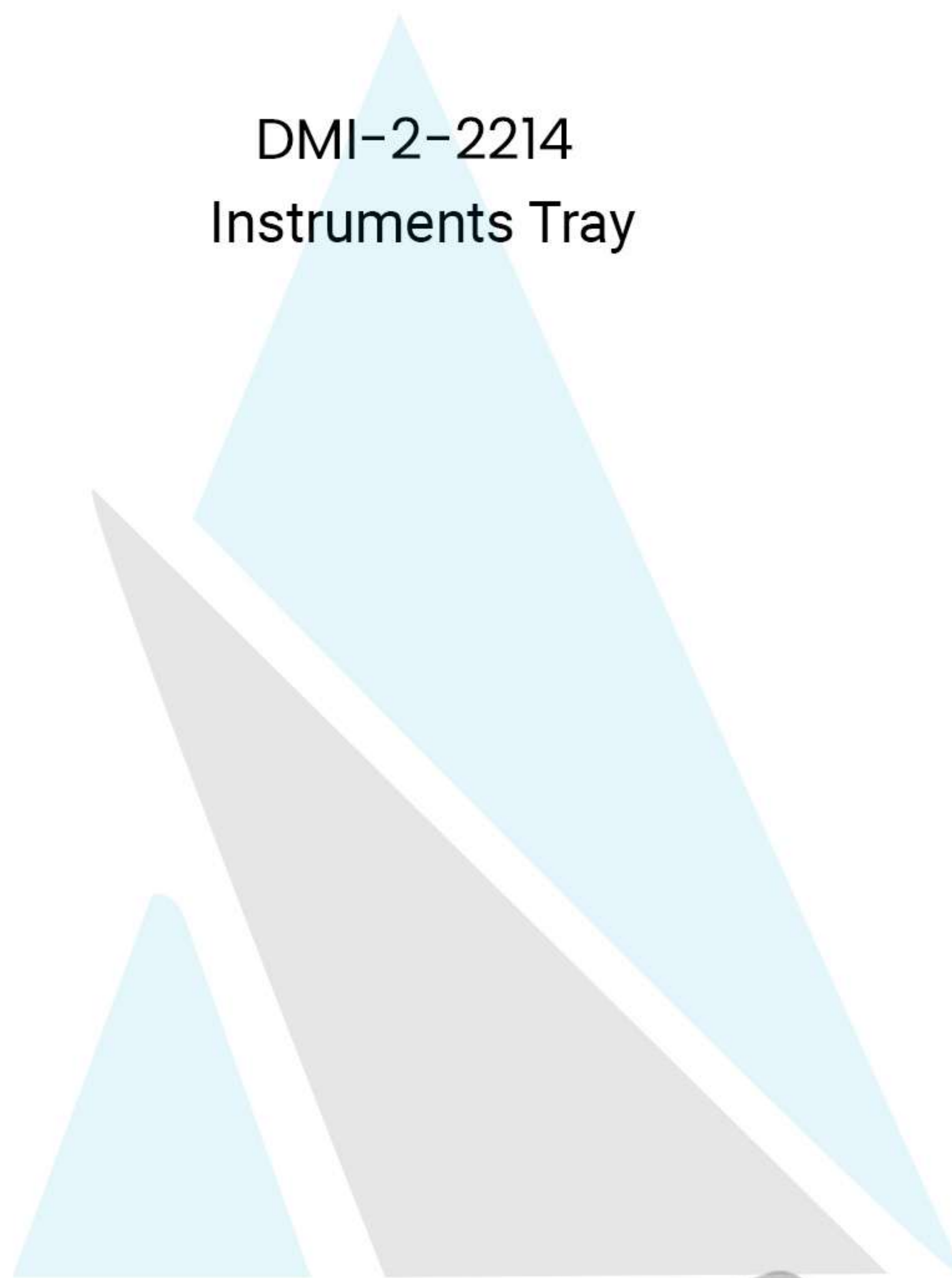

DMI-2-2216
Instruments Tray Perforated

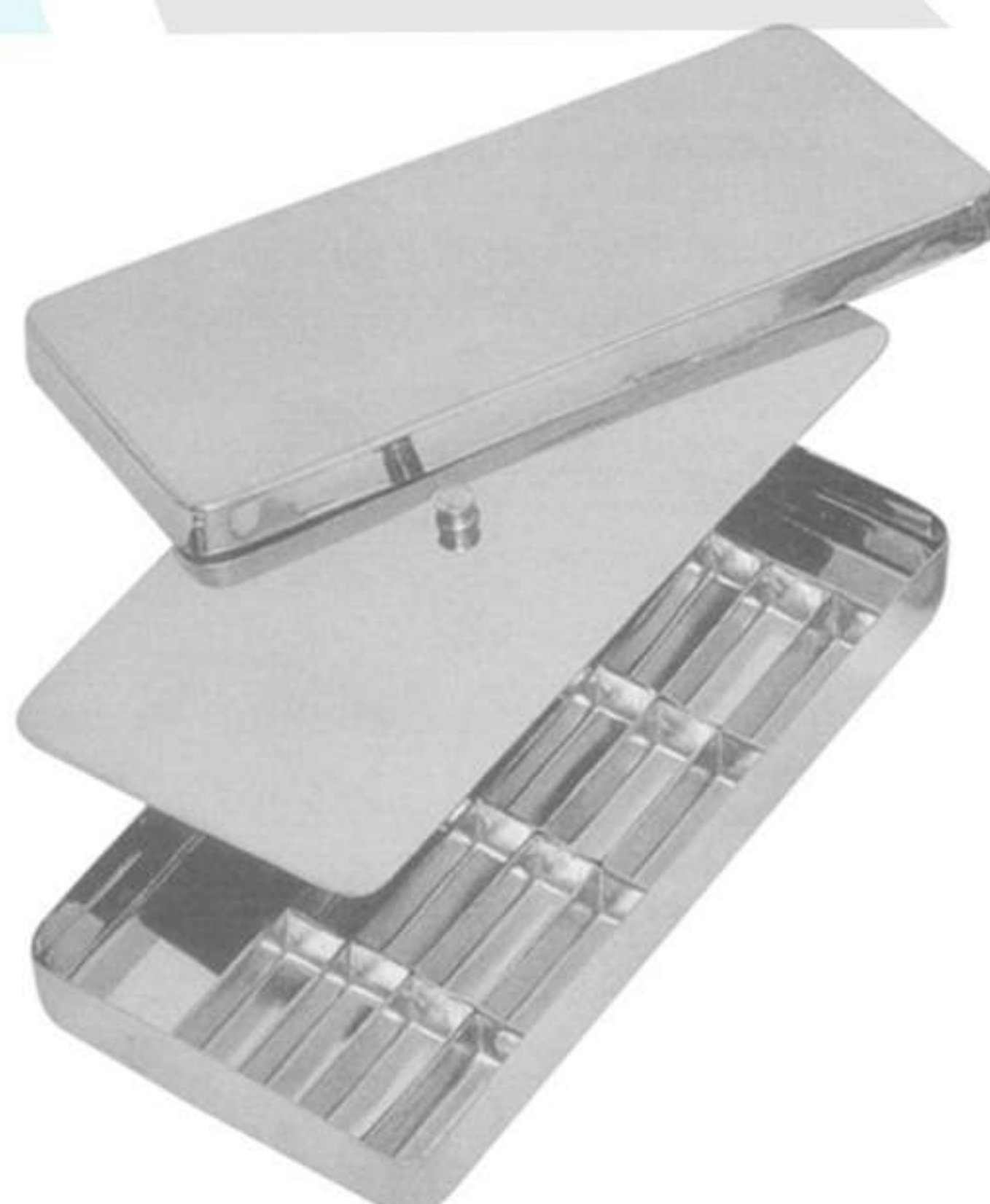

DMI-2-2217
Instruments Tray Perforated Base



DMI-2-2218
Instruments Tray Solid Base



DMI-2-2219
Pulpectomy Tray



DMI-2-2220
Sterilizing Box Available
Sizes: 17x17x3 cm 20x10x6 cm
30x14x6 cm



DMI-2-2221
Endo Tray Box



DMI-2-2222
Drum With Handle
& Lid Stainless Steel 18/10 Capa



DMI-2-2223
Sterilizing Drum 150x150mm
175x175mm 190x190mm 200x140mm
200x200mm 240x120mm 225x225mm
240x240mm 290x160mm



DMI-2-2224
Sterilizing Drum 280x240mm
230x150mm 300x250mm
340x160mm
350x250mm 390x200mm
380x300mm
100x100mm 150x120mm



DMI-2-2225
Instruments Box



DMI-2-2226
Instruments Box



DMI-2-2227
Instruments Box

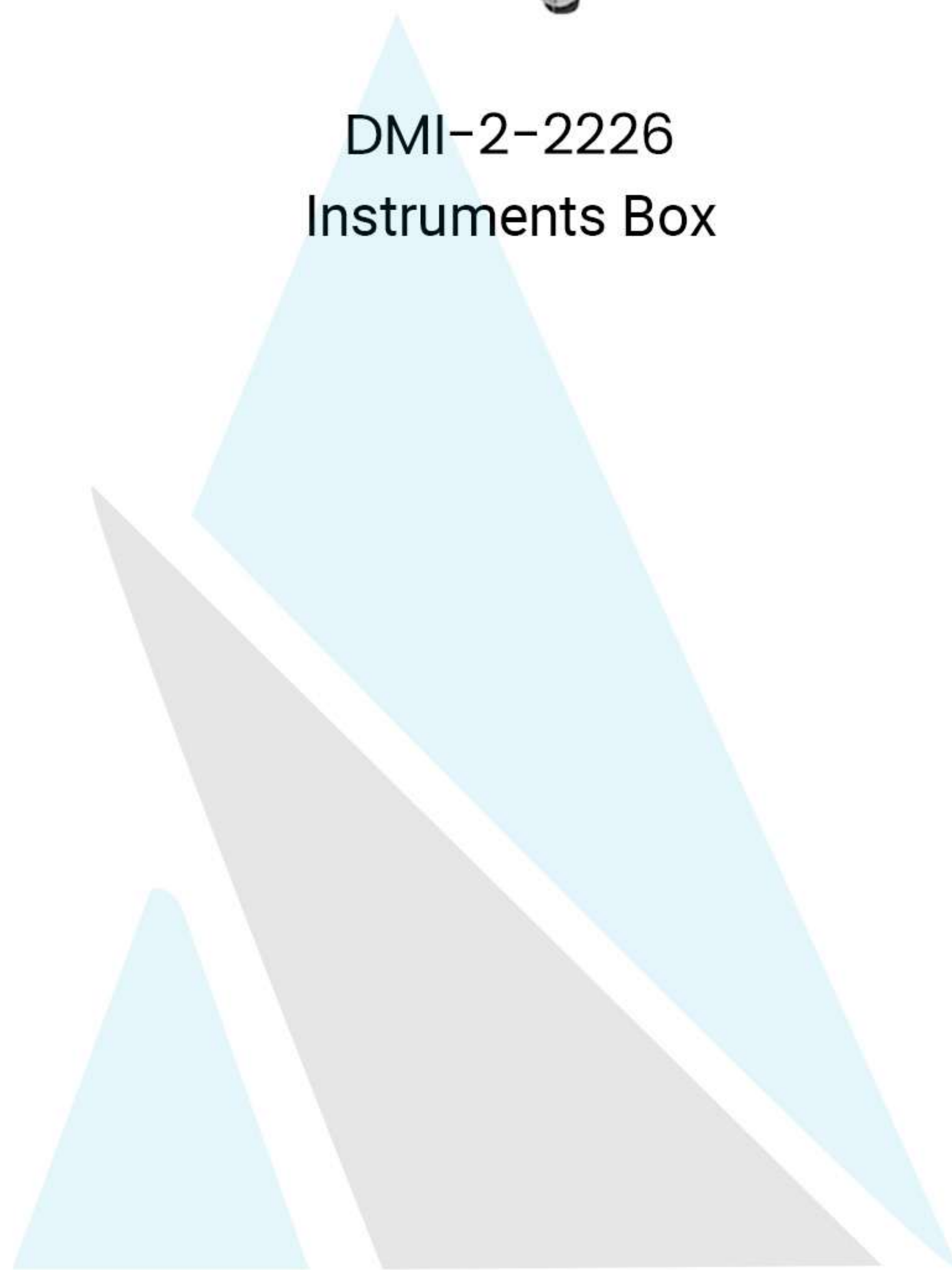

DMI-2-2228
Instruments Sterilizer 150x75 mm



DMI-2-2229
Endodontic Box



DMI-2-2230
Sterilizing Box 320x120 mm



DMI-2-2231
Instruments Tray



DMI-2-2232
Instruments Tray



DMI-2-2233
Instruments Tray (Perforated)

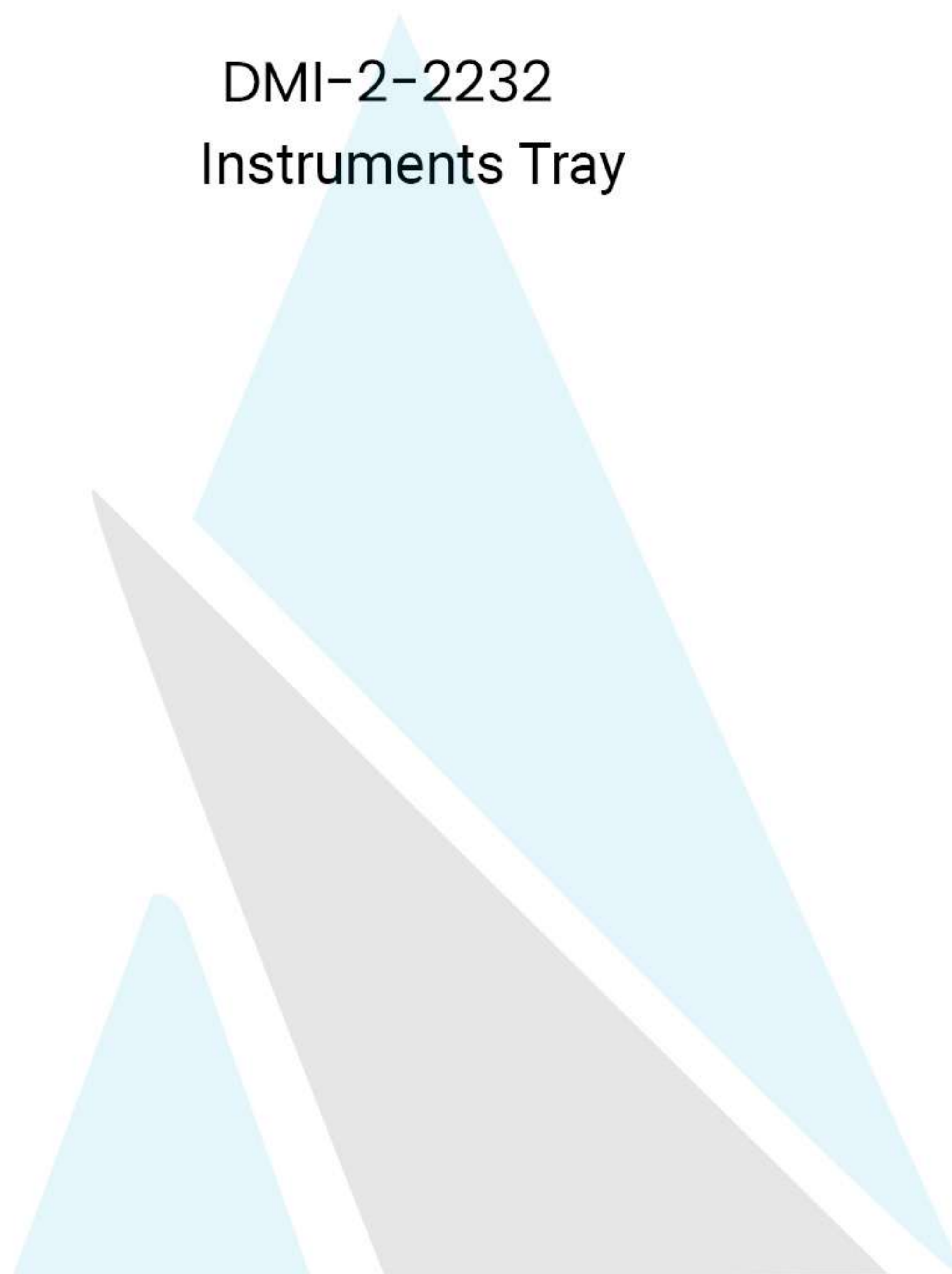

DMI-2-2234
Instruments Tray Shallow (Mayo)



DMI-2-2235
Scalers Tray



DMI-2-2236
Scalers Tray



DMI-2-2237
Articulators, Hollow Wares



DMI-2-2238
Articulators, Hollow Wares



DMI-2-2239
Articulators, Hollow Wares



DMI-2-2240
Cotton Holding Jar 60x50 mm



DMI-2-2241
Spitten Mug



DMI-2-2242
Spirit Burner With Wick
Stainless Steel 18/10 Capacity: 150 ml,
60 ml

CONTACT US

ADDRESS: DEFFENCE ROAD, MUZAFFAR PUR,
NEAR HOTEL JAFSON, Sialkot Pakistan

PHONE: +92 304 9892558/ 345 6995503

E-MAIL: info@Dentalmountaininstruments.com

WEB: www.dentalmountaininstruments.com