

SURGICAL INSTRUMENTS CATALOGUE.



Dentalmountain
INSTRUMENTS

MANUFACTURER & EXPORTER OF SURGICAL INSTRUMENTS,



ART-DMI-1-1007
Rabiner with needle and
Brush 255 mm



ART-DMI-1-1008
190 mm



ART-DMI-1-1009
Wartenbeigpin Wheel for
Neurological Examination
185 mm



ART-DMI-1-1010
155 mm



ART-DMI-1-1011
145 mm



ART-DMI-1-1012
Stethoscope with diaphragm



DMI-1-1007
Rabiner with needle and
Brush 255 mm



DMI-1-1008
190 mm



DMI-1-1009
Wartenbeigpin Wheel for
Neurological Examination
185 mm



DMI-1-1010
155 mm



DMI-1-1011
145 mm



DMI-1-1012
Stethoscope with diaphragm



DMI-1-1013
Diagnostics, Anaesthesia
and other Instruments



DMI-1-1014
Dual Chest Piece with
two Outlets



DMI-1-1015
Bowles

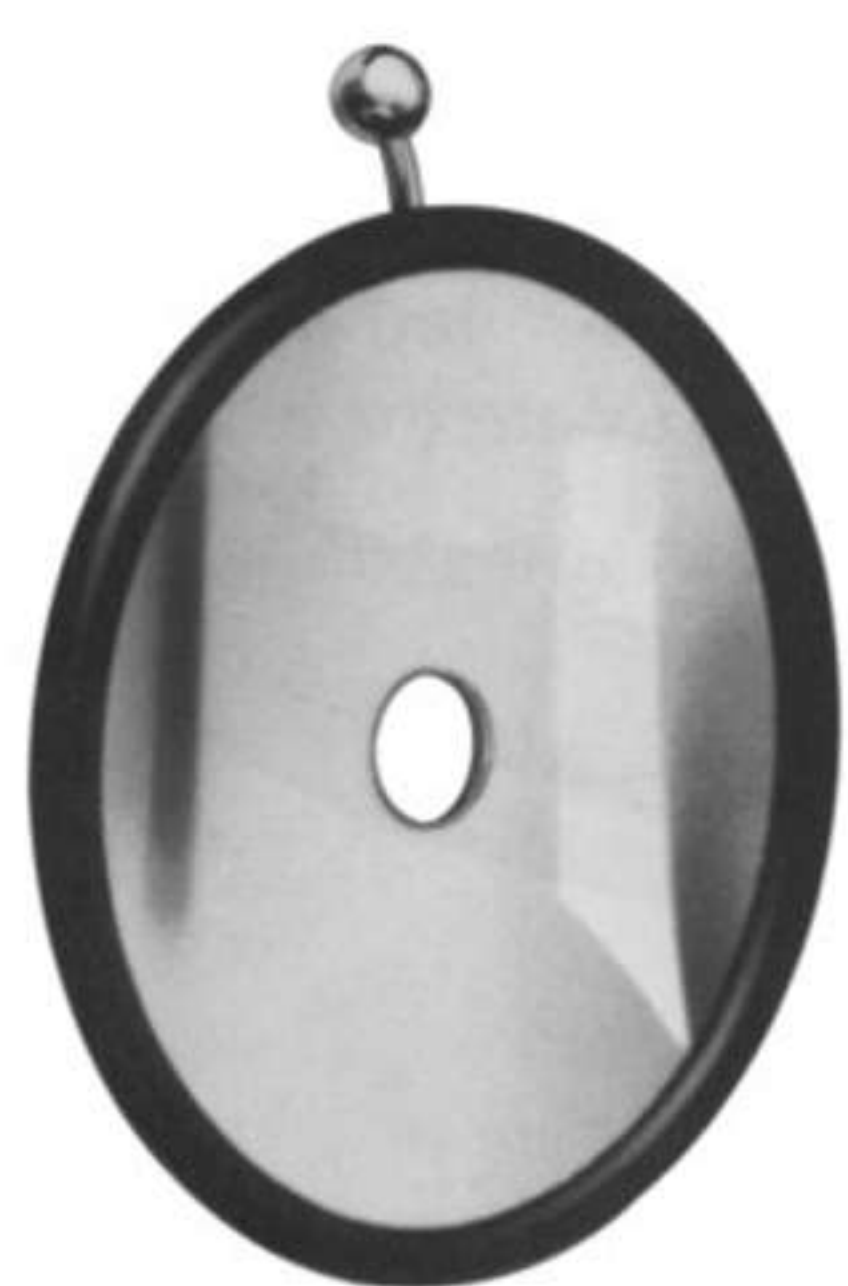

DMI-1-1016
90 mm Head Mirror only
with rubber Coating

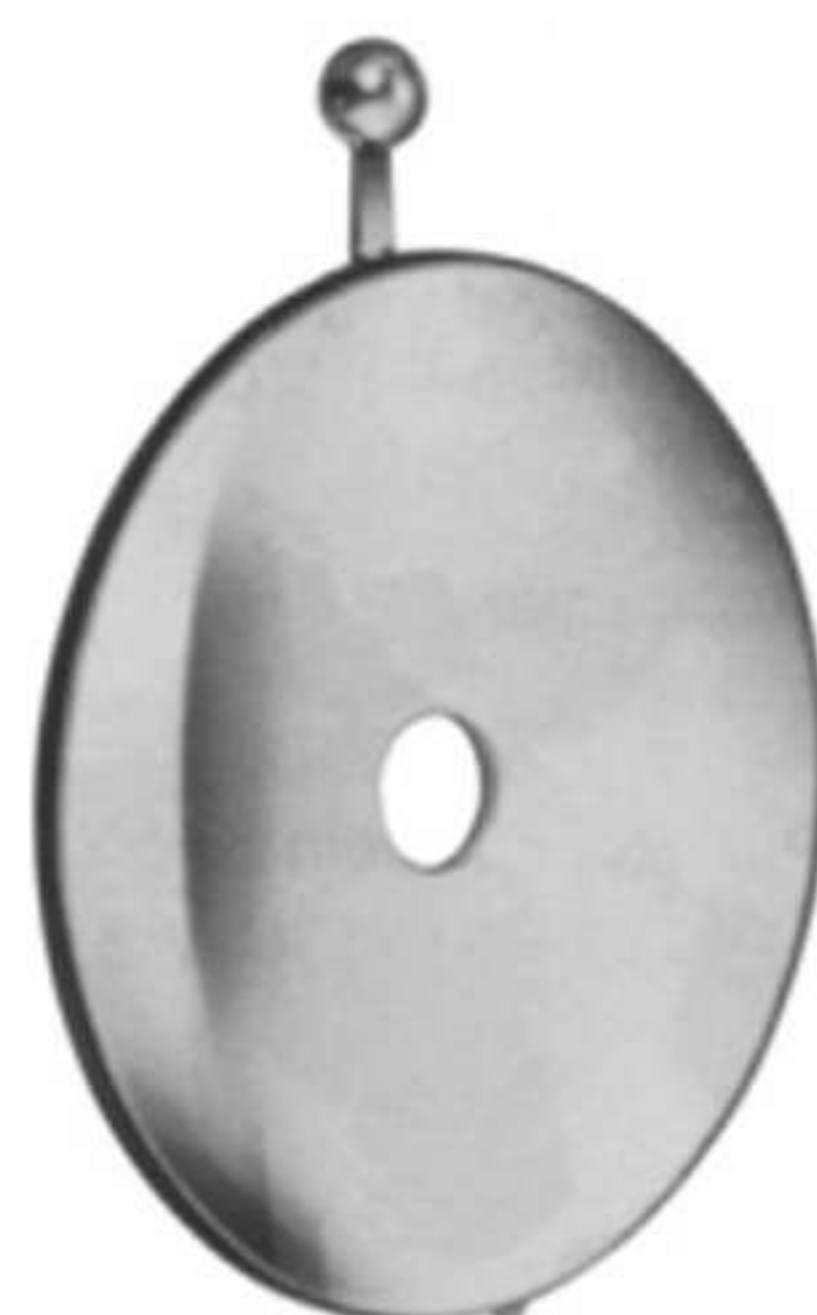

DMI-1-1017
Ziegler 90mm Head mirror
only with metal coating



DMI-1-1018
Ziegler Head band of
Plastic Black



DMI-1-1019
Ziegler Head band and
Plastic White



DMI-1-1020
Murphy head band of
Celluloid , White



DMI-1-1021
head band plastic, white,
soft pattern



DMI-1-1022
head mirror with black
plastic head band



DMI-1-1023
150mm



DMI-1-1024
145mm 145mm



DMI-1-1025
140mm



DMI-1-1026
180mm

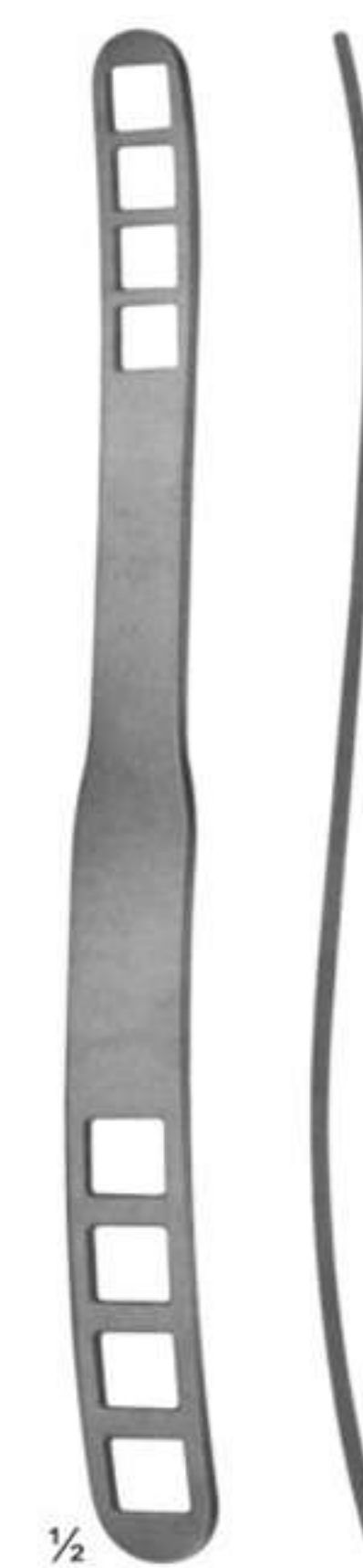

DMI-1-1027
Bruenings 190mm

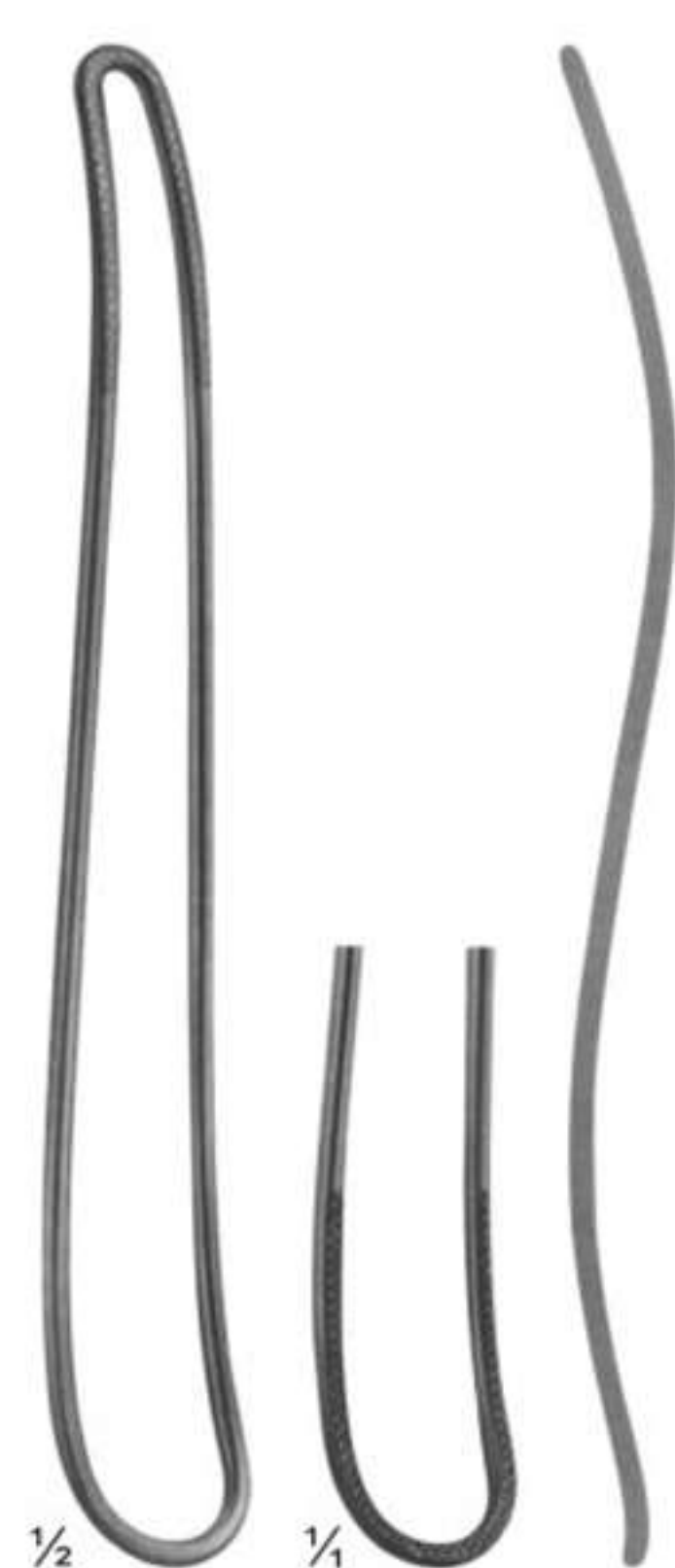

DMI-1-1028
Frenzel 165mm



DMI-1-1029
Simplex 110mm



DMI-1-1030
Sternberg 120mm, 140mm,
160mm



DMI-1-1031
Tobold 145mm



DMI-1-1032
Andrew 110mm



DMI-1-1033
Wieder



DMI-1-1034
Schimmelbusch Ether mask



DMI-1-1035
Heister Mouth Gag 130mm



DMI-1-1036
Fergusson-Ackland Mouth gag
145mm



DMI-1-1037
Denhardt Mouth gag with
silicon inserts, interchangeable
Size : 125mm

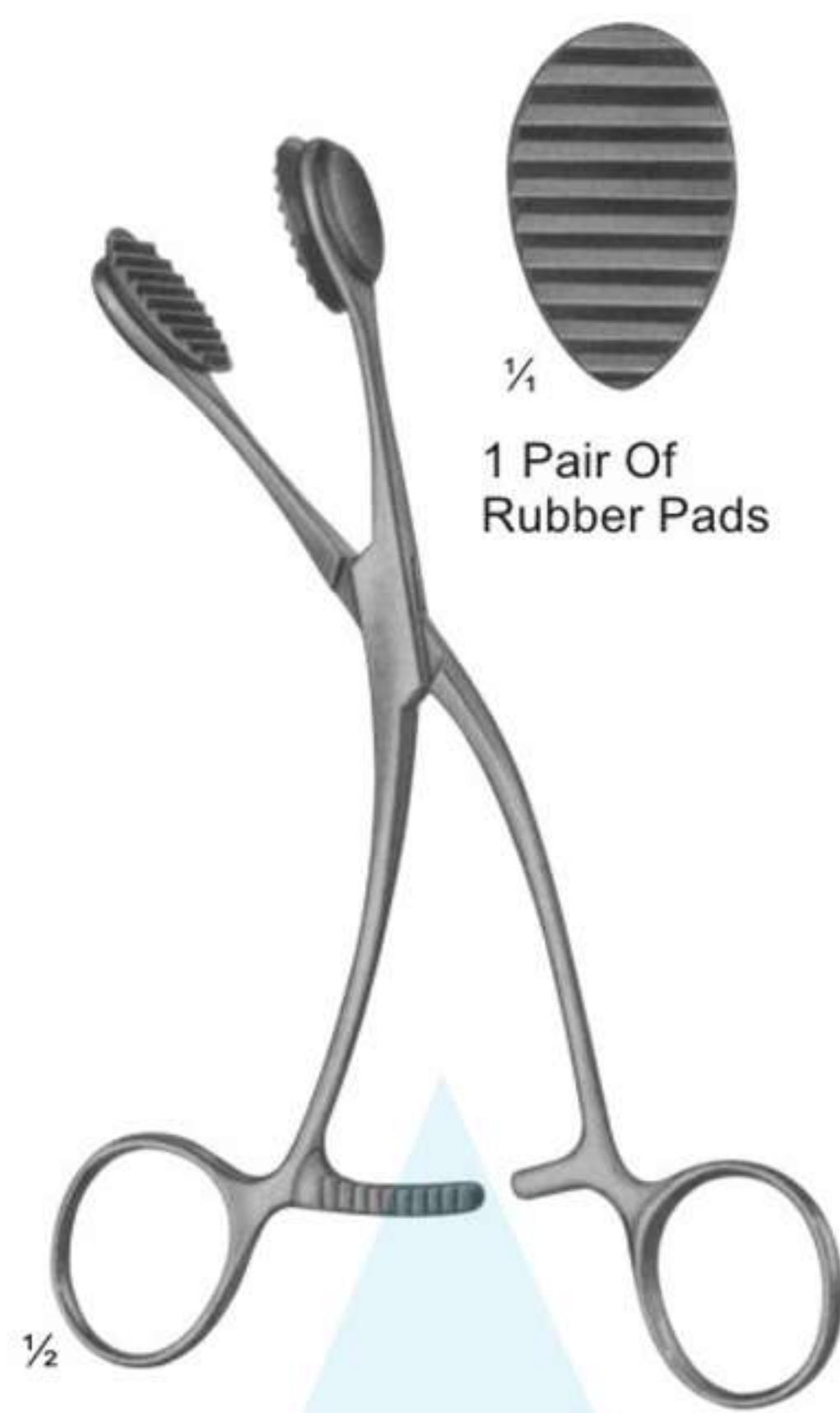

DMI-1-1038
Young 165mm

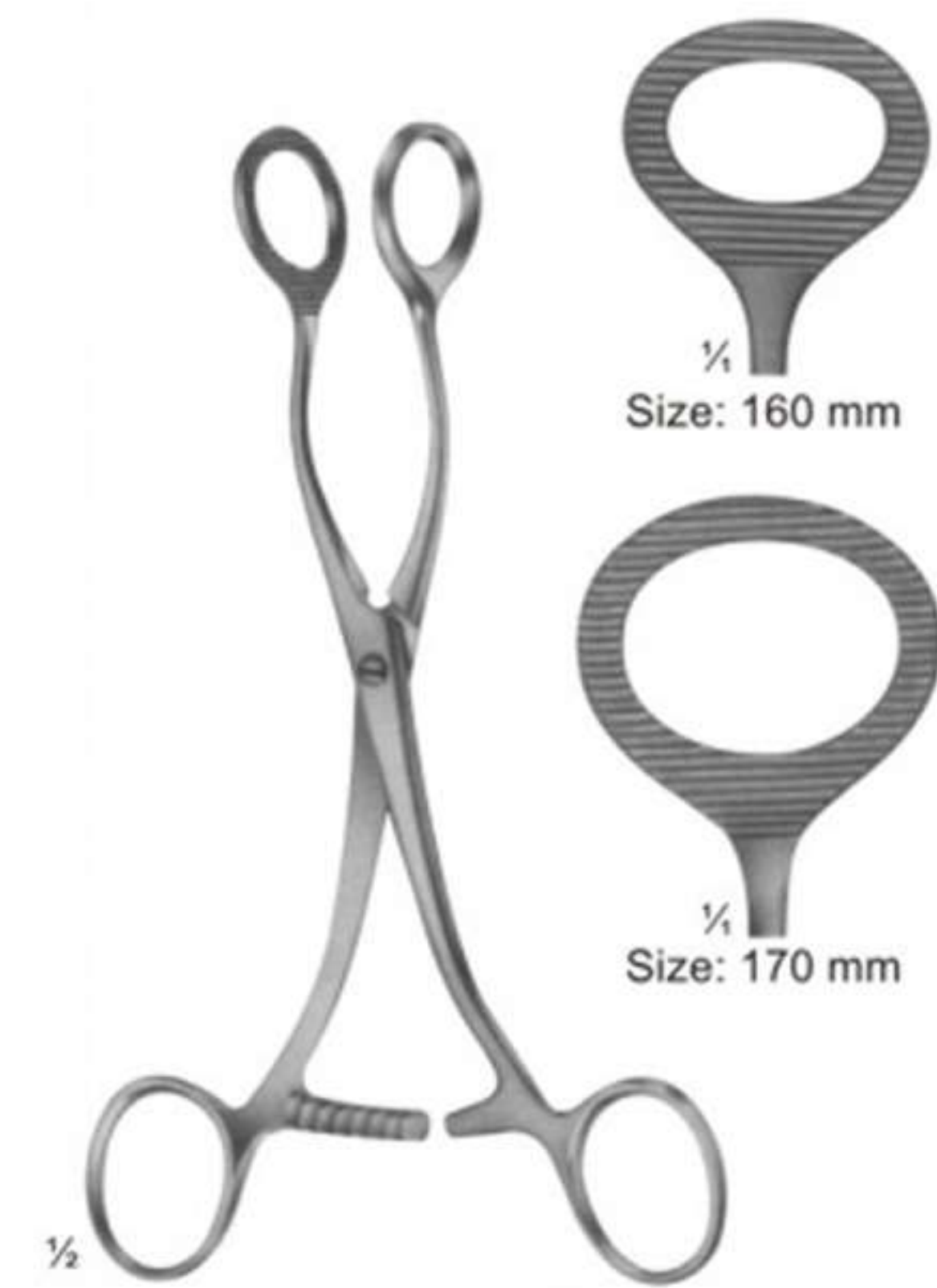

DMI-1-1039
Collin 160mm, 170mm

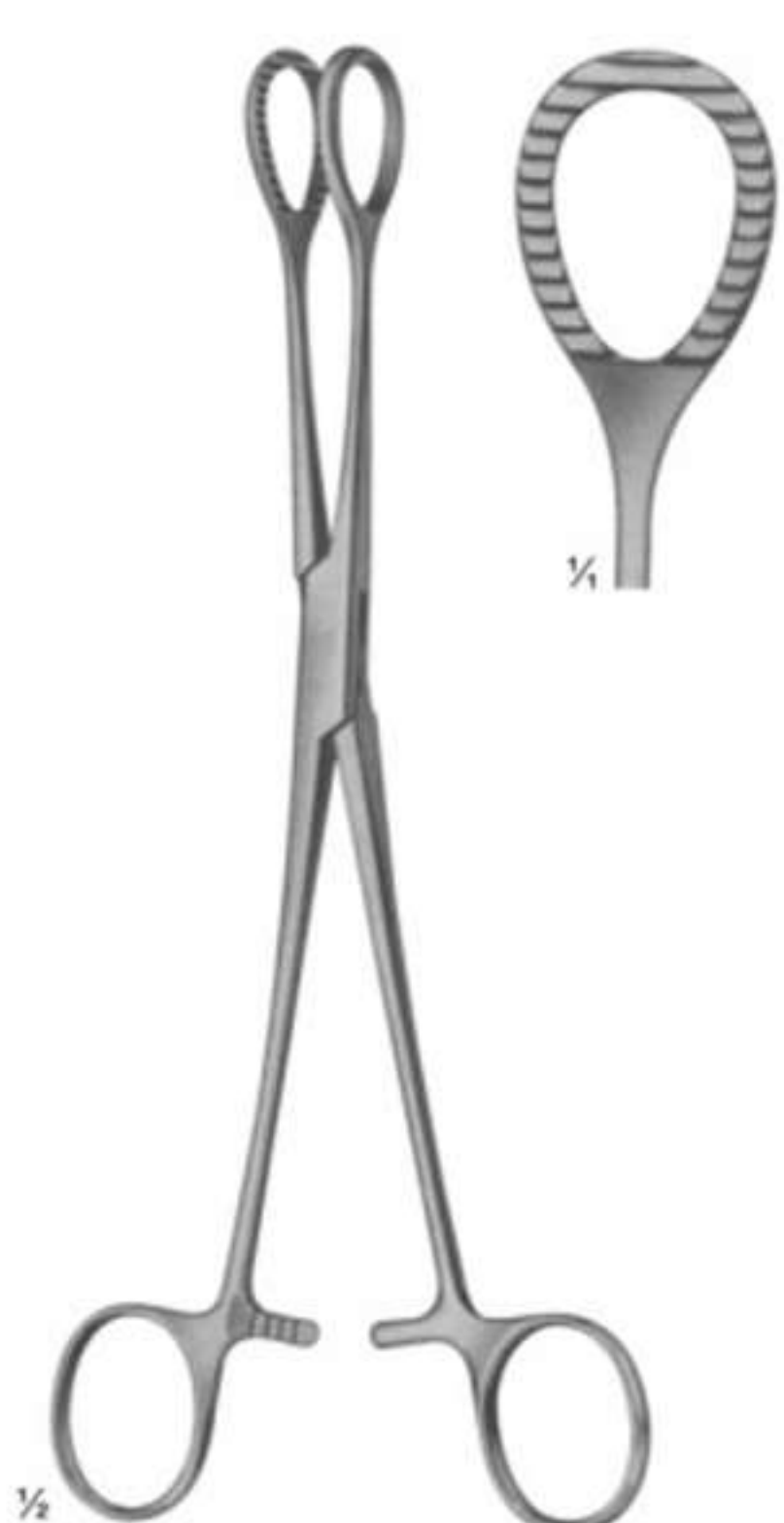

DMI-1-1040
Heywood Smith Modif,
215mm



DMI-1-1041
Francke Automatic blood lancet



DMI-1-1042
Laryngeal Mirrors with Hexagonal
Handle 180mm



DMI-1-1043
Kolle Microscopic NEEDLE Holder
with Plastic Handle 240mm



DMI-1-1044
Mirror handle 110mm



DMI-1-1045
Collin 160mm, 170mm



DMI-1-1046
Michel Rhinoscopic mirrors
with interchangeable mirror
inserts 250mm



DMI-1-1047
Spare mirror only 12mm



DMI-1-1048
Spare mirror only 14mm



DMI-1-1049
Magill catheter introducing
Forceps infants 150mm



DMI-1-1050
Magill catheter introducing
Forceps CHILDREN 200MM

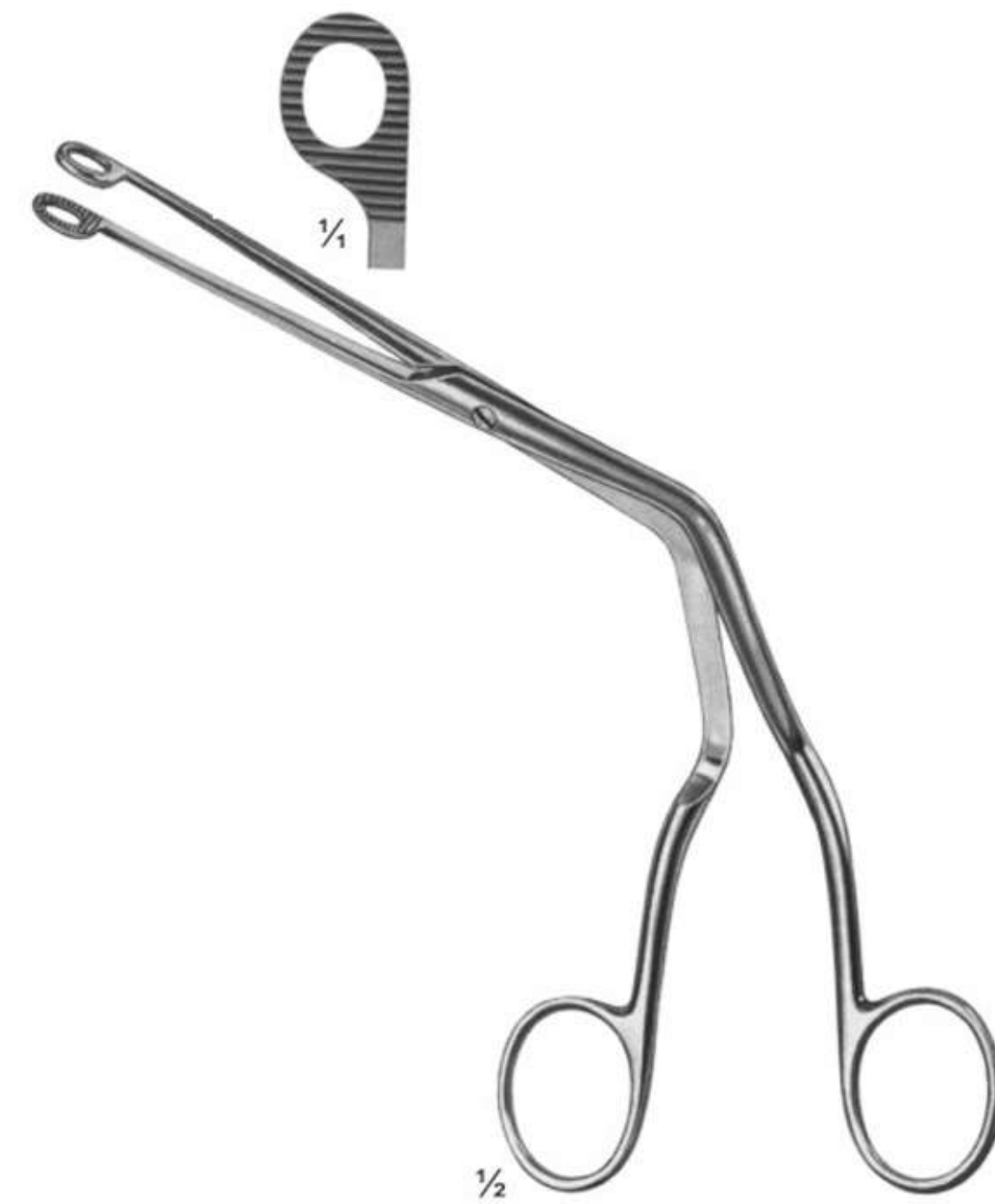

DMI-1-1051
Magill catheter introducing Forceps
ADULTS 250mm



DMI-1-1052
Medium battery handle only
25mm diam



DMI-1-1053
Spare bolb 2.7 volt, otoscopes



DMI-1-1054
Oroscope & Pouch



DMI-1-1055
ENT set



DMI-1-1056
Otoscope, Consists of battery handle
without batteries, 3 ear specula, 1 BULB in
valvet lined case



DMI-1-1057
Set with three specula



DMI-1-1058
Laryngoscope set, Consists of battery
handle (without battery) with five miller
laryngoscope blades



DMI-1-1059
Guedel-Negus Laryngoscope set,
Consists of battery handle
(without battery) with five miller
laryngoscope blades



DMI-1-1060
McINTOSH Laryngoscope Set, Consists,
of Battery Handle (Without Battery)
with Three McINTOSH Blades,
Fig. 1, Fig. 2, Fig. 3



1/3

DMI-1-1061

Foregger Laryngoscope Set, Consists of Battery Handle (without Battery) with Three Foregger Blades, Fig. 1, Fig. 2, Fig. 3



1/3

DMI-1-1062

Foregger Laryngoscope Set, Consists of Battery Handle (without Battery) with Three Foregger Blades, Fig. 1, Fig. 2, Fig. 3, Fig. 4



1/2

DMI-1-1063
Fiber Optic Battery Handle
30mm diam



1/2

DMI-1-1064
Fiber Optic Battery HANDLE
18mm diam.



1/4

DMI-1-1065
Replacement Lamp (Krypton)
2.5 V



1/4

DMI-1-1066
Replacement Lamp (Halogen) 2.5 V



DMI-1-1067

Caliper of Aluminium Graduated in mm
& inches up to 180mm Measuring
Range up to 139mm



DMI-1-1068

Universal Caliper of Steel Graduated in mm
& inches up to 180mm Measuring Range up to
120mm with Vernier in 1/10mm & 1/16



DMI-1-1069

145 mm Finger Goniometer



DMI-1-1070

Townley Graduated in mm
& inches 115mm



DMI-1-1071

Collin Druck Pressure
72 kg 125mm



DMI-1-1072
Bertillon Caliper for Measuring
the Head 320mm



DMI-1-1073
Castroviejo Caliper 75mm

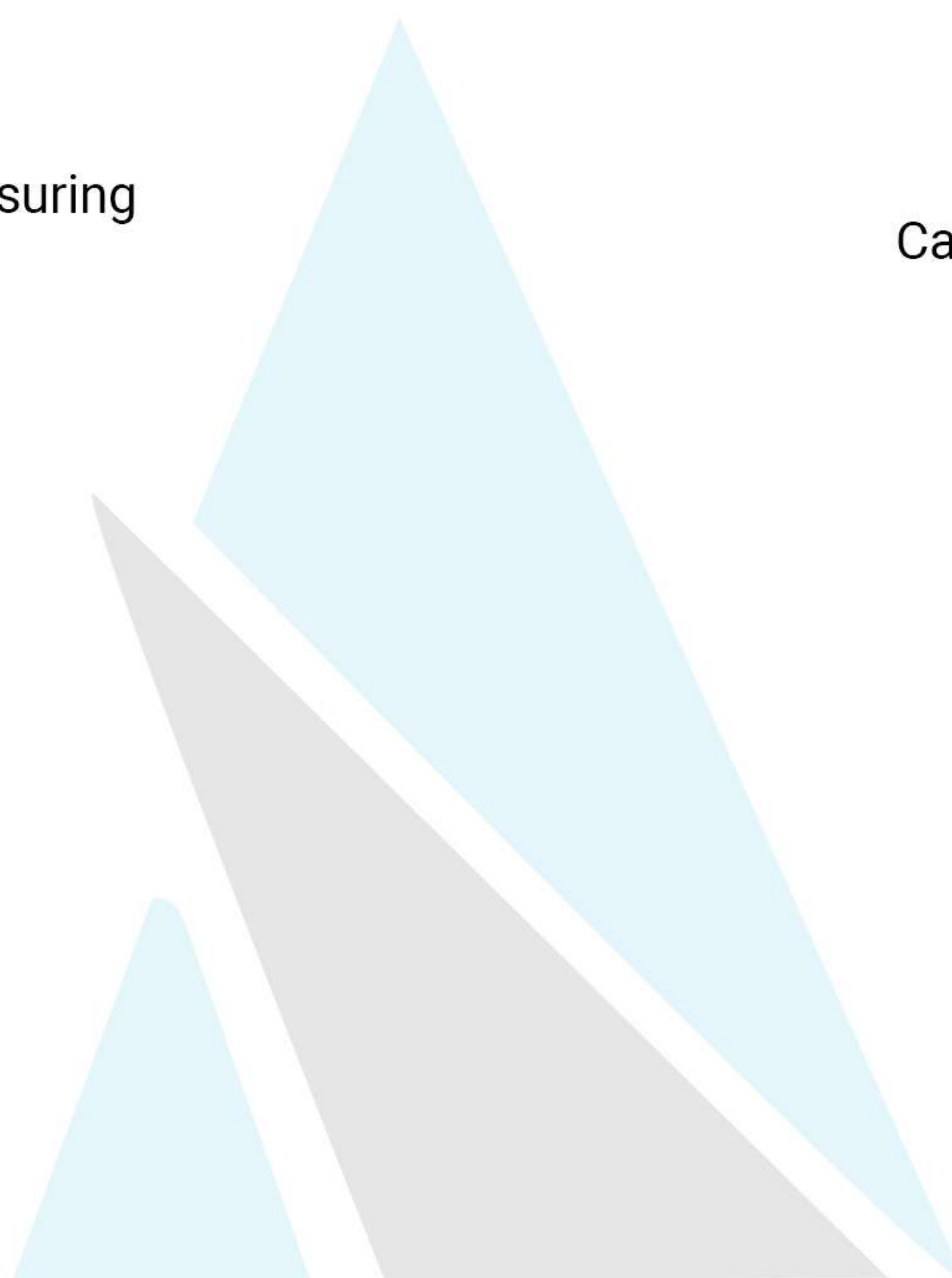

DMI -1-1074
Moltgen Goniometer



DMI-1-1101
Fig. 130mm



DMI-1-1102
Fig. 236mm



DMI-1-1103
Fig. 340mm



DMI-1-1104
Fig. 445mm



DMI-1-1105
Fig. 627mm



DMI-1-1106
Fig. 627mm



DMI-1-1107
Fig. 735mm



DMI-1-1108
Fig. 840mm



DMI-1-1109
Fig. 947mm

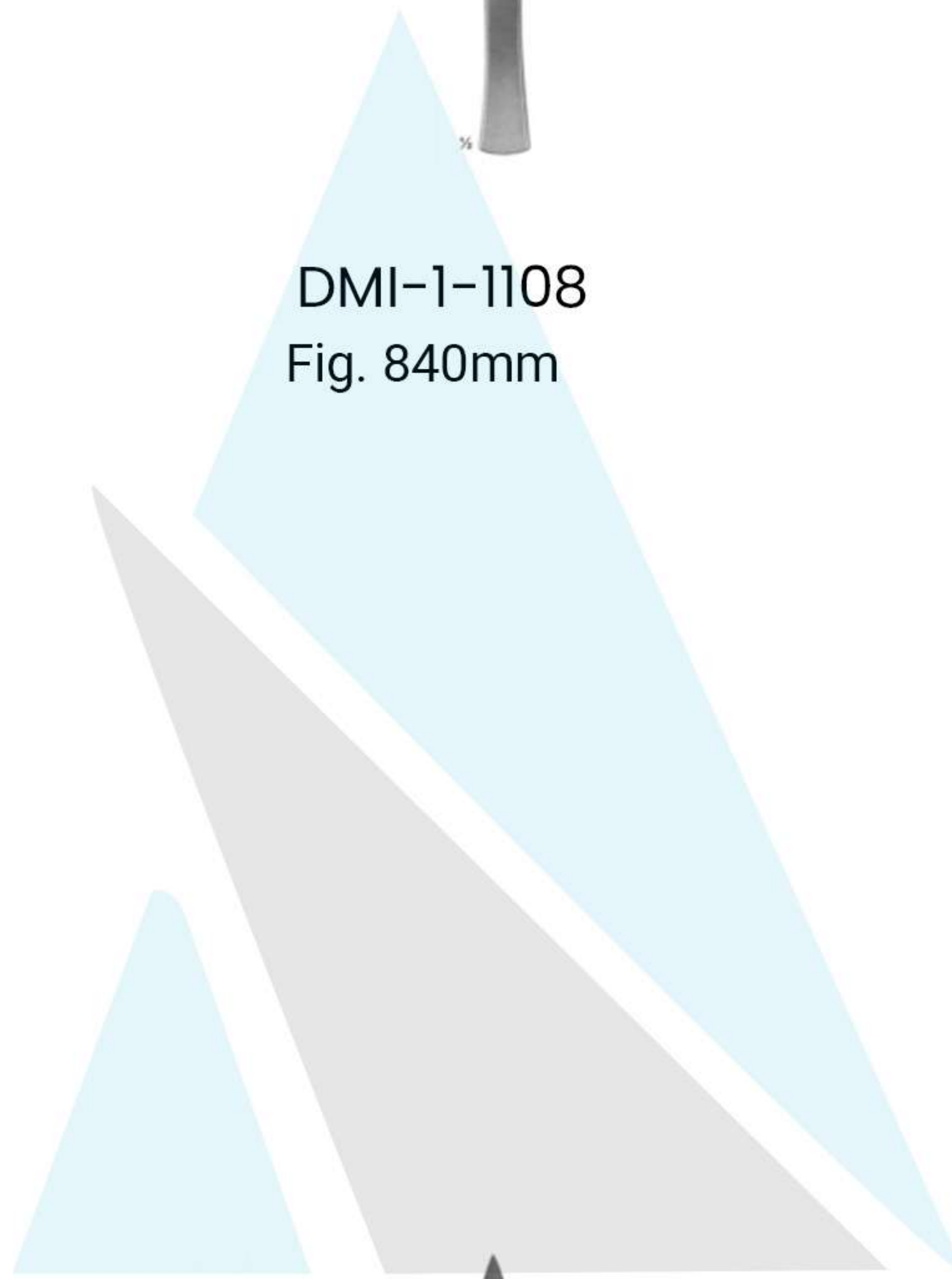

DMI-1-1110
Fig. 1050mm



DMI-1-1111
Liston Blade Length
Amputating Knives 130mm



DMI-1-1112
Liston Blade Length
Amputating Knives 160mm



DMI-1-1113
Liston Blade Length
Amputating Knives 190mm



DMI-1-1114
Liston Blade Length
Amputating Knives 200mm



DMI-1-1115
Catlin 160mm Blade
Length Amputating Knives



DMI-1-1116
Langenbeck 120mm Blade
Length Flap Kinives



DMI-1-1117
110mm Blade Length
interosseous Kinives



DMI-1-1118
55mm Blade Length with
raspatory Wooden Handle



DMI-1-1119
70mm Blade Length
Wooden Handle



DMI-1-1120
80mm Blade Length Metal Handle



DMI-1-1121
195mm Blade Length Metal Handle



DMI-1-1122
Ayre 235mm Cone Knife



DMI-1-1123
Size: 230 mm Cone Knife



DMI-1-1124
SEGOND SEGOND Size: 270
mm Myotome



DMI-1-1125
OLIVECRONASize: 205
mmTrigeminal Knife



DMI-1-1126
Size: 230 mmTrigeminal Knife



DMI-1-1127
FOWLERSize: 200 mmTonsil Knife



DMI-1-1128
ABRAHAMSize: 215
mmTonsil Knife



DMI-1-1129
RUNINGSSSize: 215 mmTonsil Knife



DMI-1-1130
STANDARDNo. 3Solid12 cm



DMI-1-1131
No. 3 Solid 12 cm



DMI-1-1132
No. 3 Solid 12 cm



DMI-1-1133
No. 3 L Straight Solid 21.5 cm



DMI-1-1134
No. 3 L Angled Solid 21 cm



DMI-1-1135
No. 7 Solid 16 cm



DMI-1-1136
No. 7 K Solid 12.5 cm



DMI-1-1137
Hollow-Round 15.5 cm



DMI-1-1138
No. 3 Straight Solid, Round 14.5 cm



DMI-1-1139
No. 3 Angled Solid, Round 14 cm

Scissors



DMI-1-1201
VANNAS Size: 85 mm



DMI-1-1202
VANNAS Size: 85 mm



DMI-1-1203
VANNAS Size: 85 mm

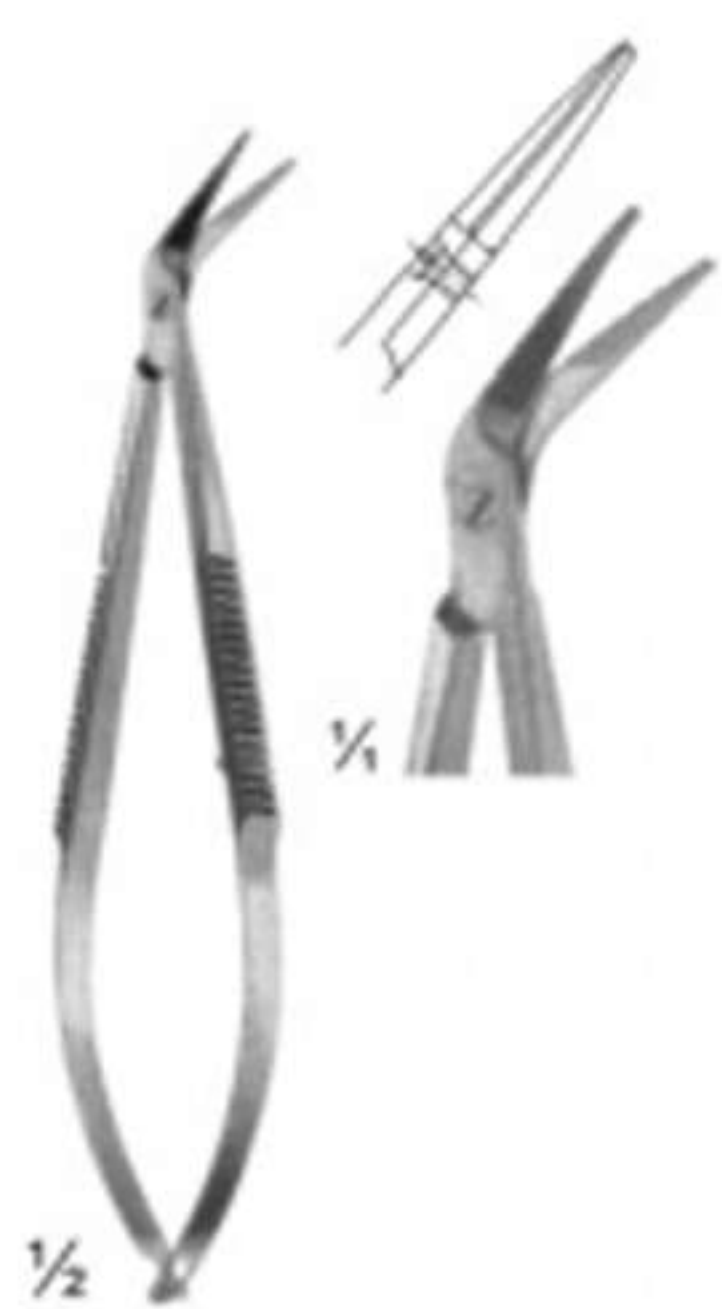
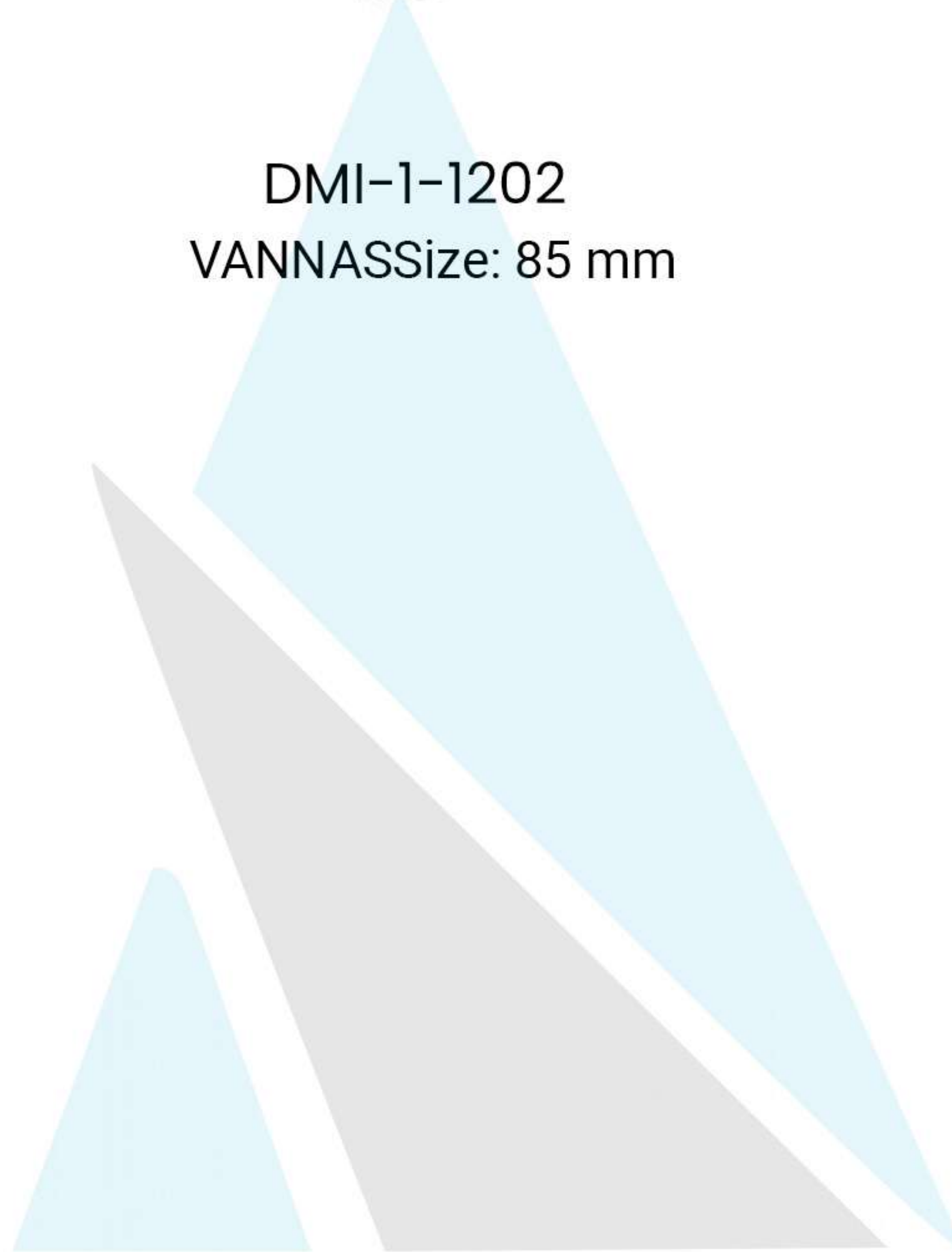

DMI-1-1204
CASTROVIEJO Size: 95 mm



DMI-1-1205
CASTROVIEJO Size: 95 mm

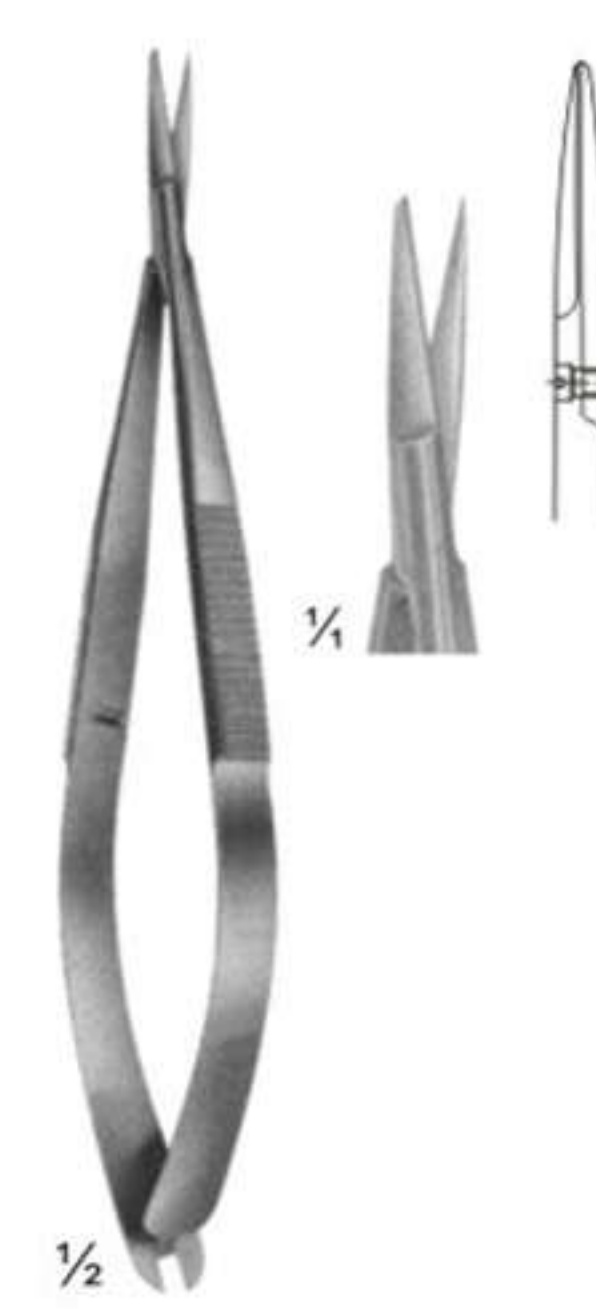

DMI-1-1206
NOYESS Size: 125 mm

Scissors

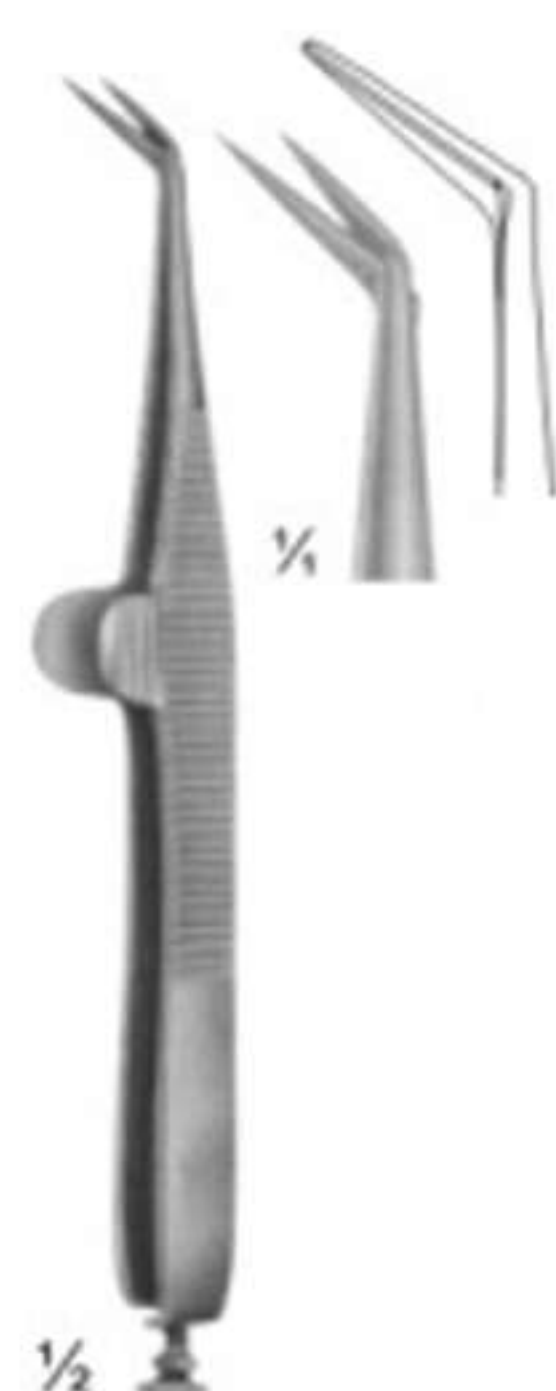

DMI-1-1207
WECKER Eye scissor
Size: 110 mm



DMI-1-1208
WECKER Eye scissor
Size: 110 mm

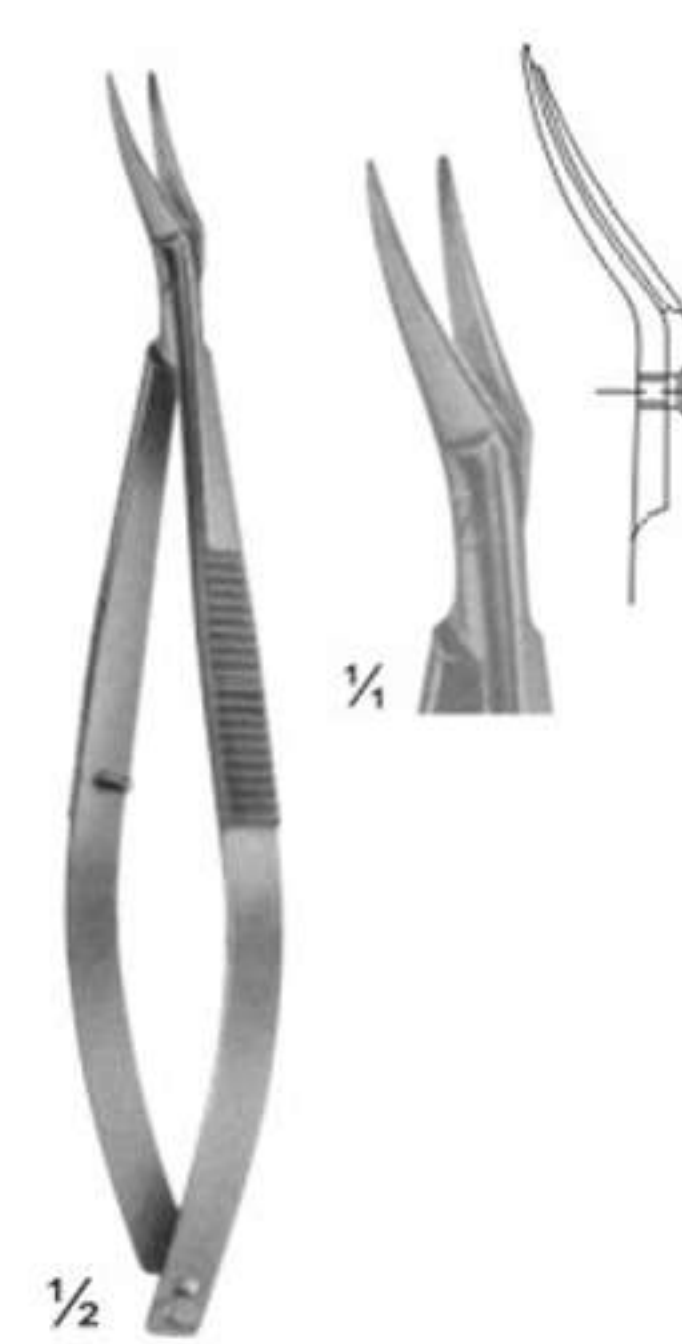

DMI-1-1209
CASTROVIEJO Eye scissor
Size: 115 mm

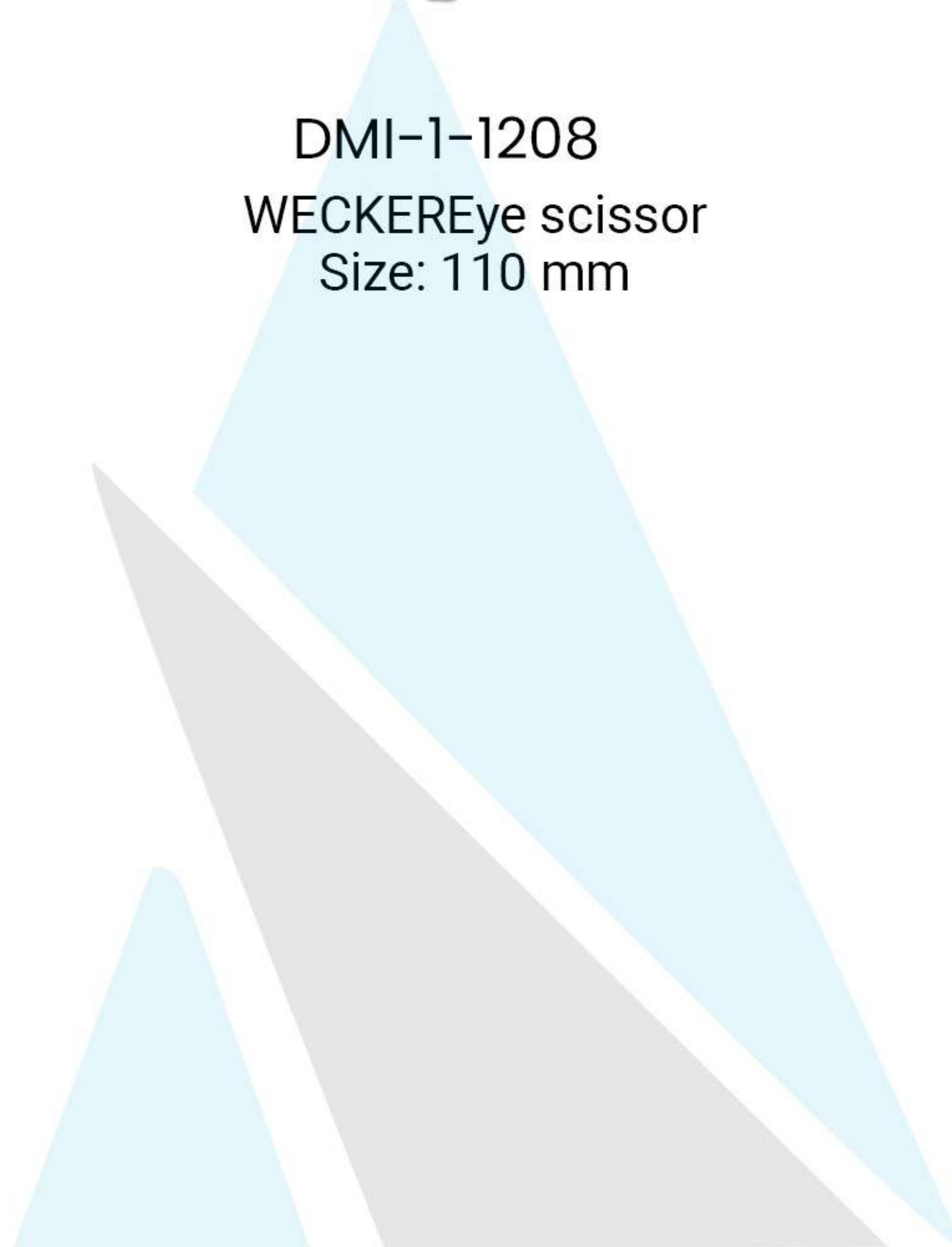

DMI-1-1210
CASTROVIEJO Eye scissor
Size: 110 mm



DMIC-1-1211
CASTROVIEJO Eye scissor
Size: 110 mm



DMI-1-1212
Size: 120 mm

Scissors



DMI-1-1213
Size: 120 mm



DMI-1-1214
BIEMERVein scissor
Size: 130 mm



DMI-1-1215
Size: 160 mm



DMI-1-1216
VANNAS
Size: 160 mm



DMI-1-1217
VANNAS
Size: 160 mm

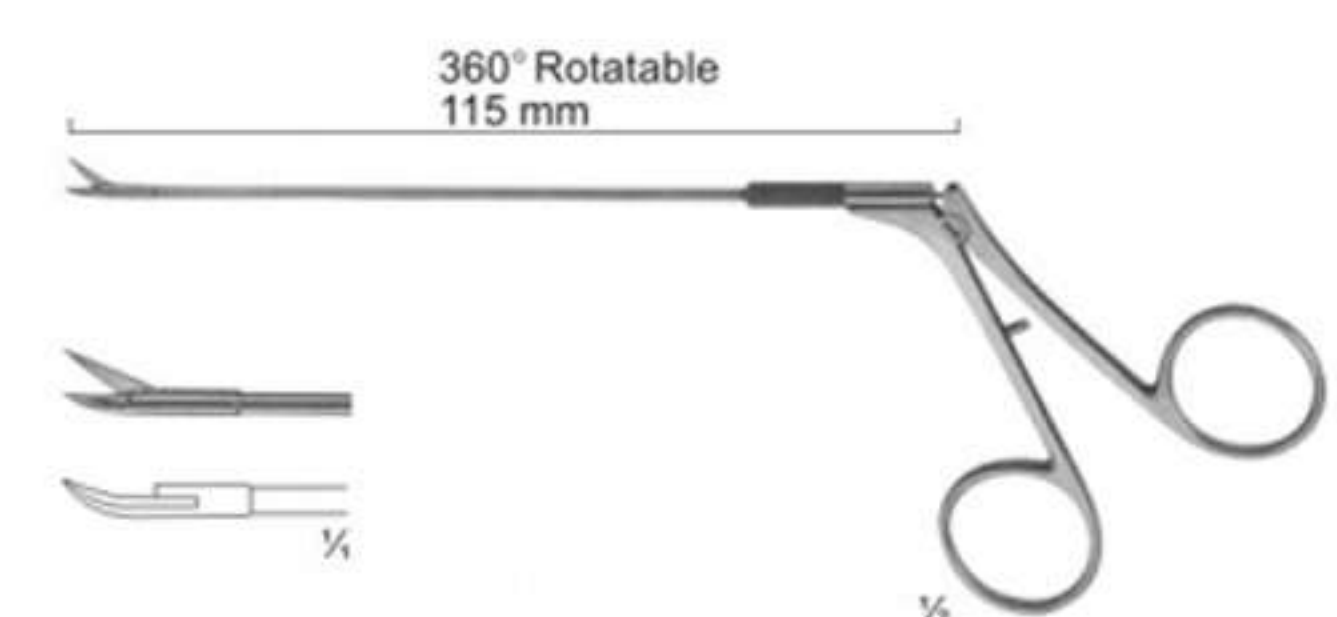

DMI-1-1218
CASPAR
Micro scissor curved
Size: 115 mm

Scissors



DMI-1-1219
Micro dissecting scissor
Size: 145 mm



DMI-1-1220
Micro dissecting scissor
Size: 145 mm



DMI-1-1221
Micro dissecting scissor
Size: 145 mm

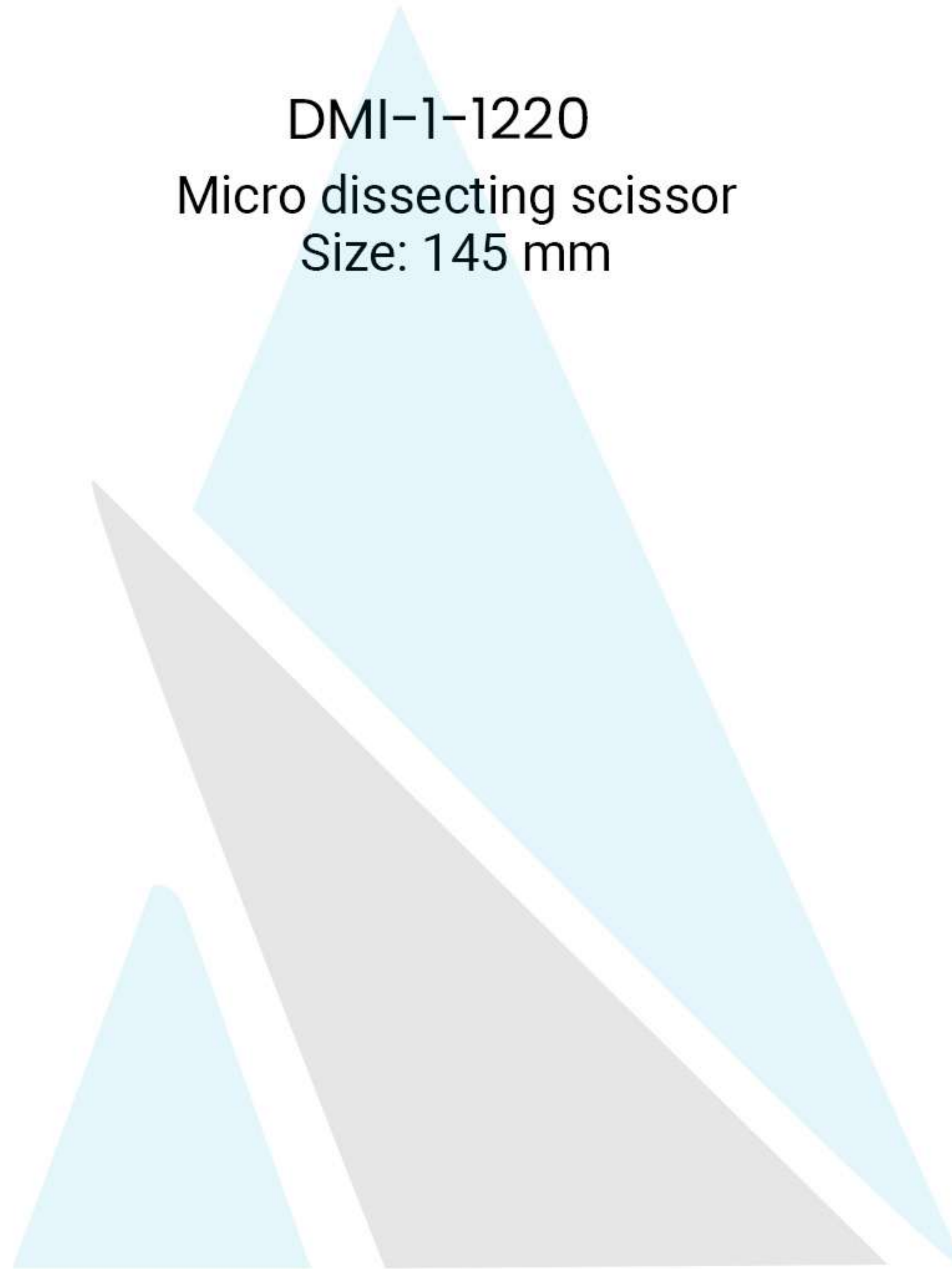

DMI-1-1222
laterally angled
Size: 200 mm



DMI-1-1223
laterally angled
Size: 200 mm



DMI-1-1224
laterally angled
Size: 200 mm

Scissors



DMI-1-1225
laterally angled Size: 190 mm



DMI-1-1226
YASARGIL Size: 225 mm



DMI-1-1227
YASARGIL Size: 225 mm

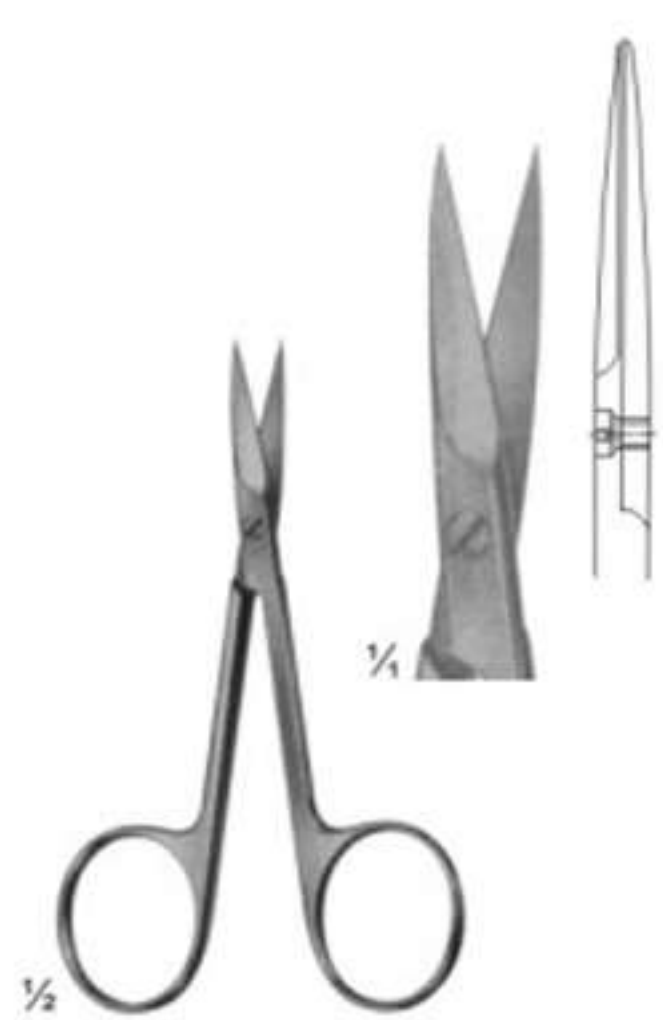

DMI-1-1228
Size: 90 mm

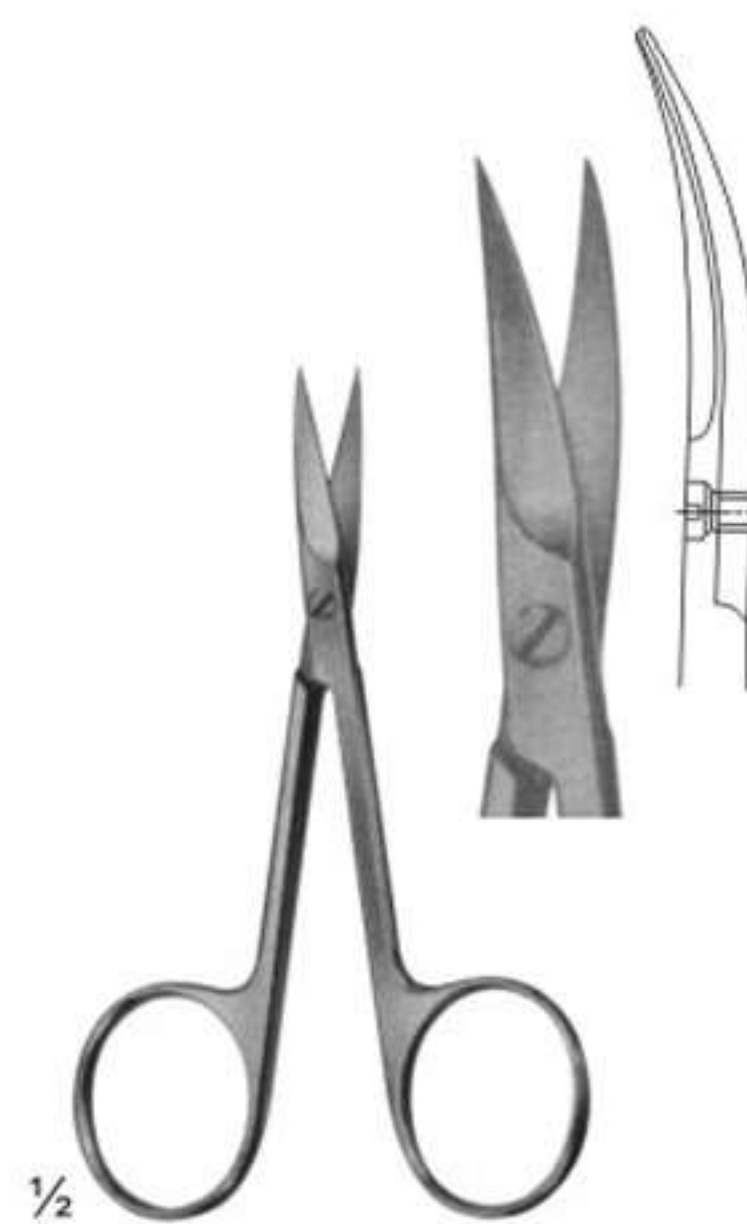

DMI-1-1229
Size: 90 mm

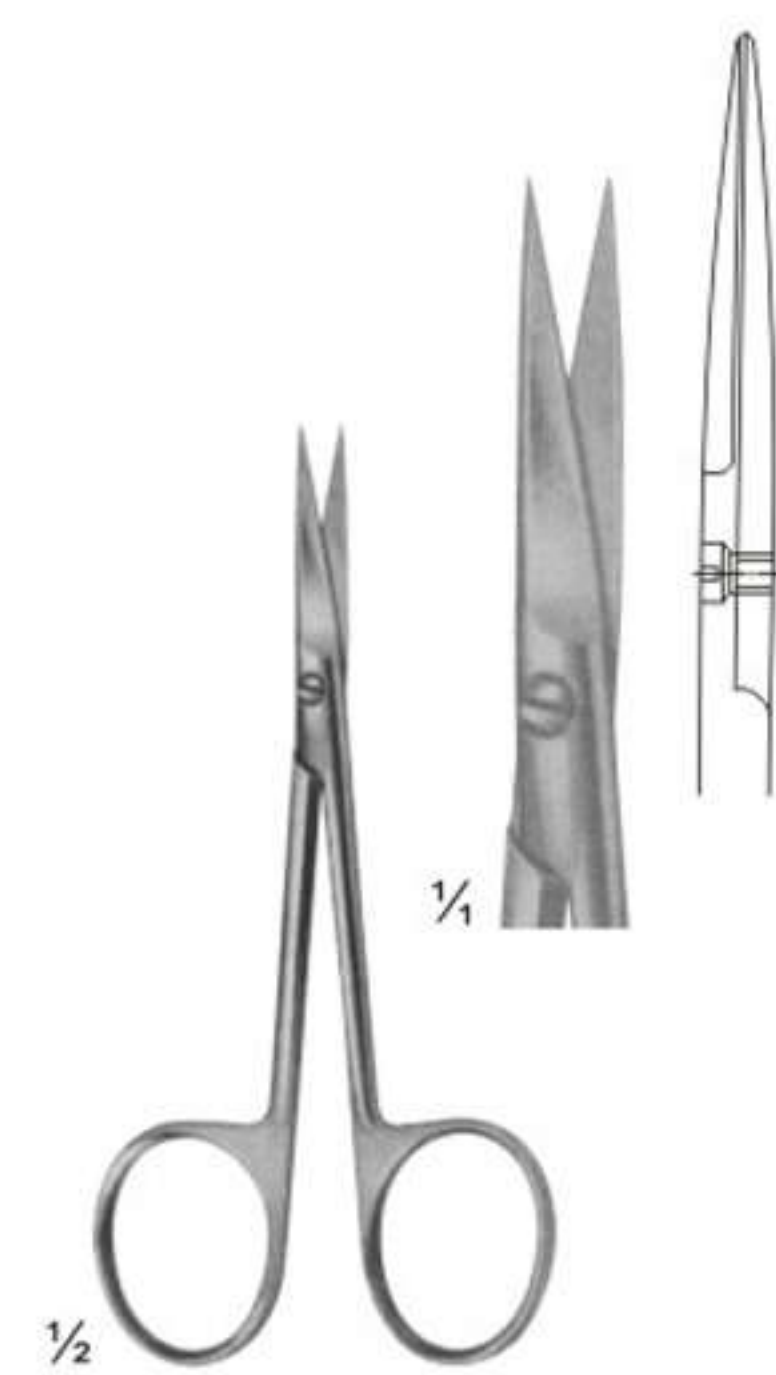

DMI-1-1230
Size: 95 mm

Scissors

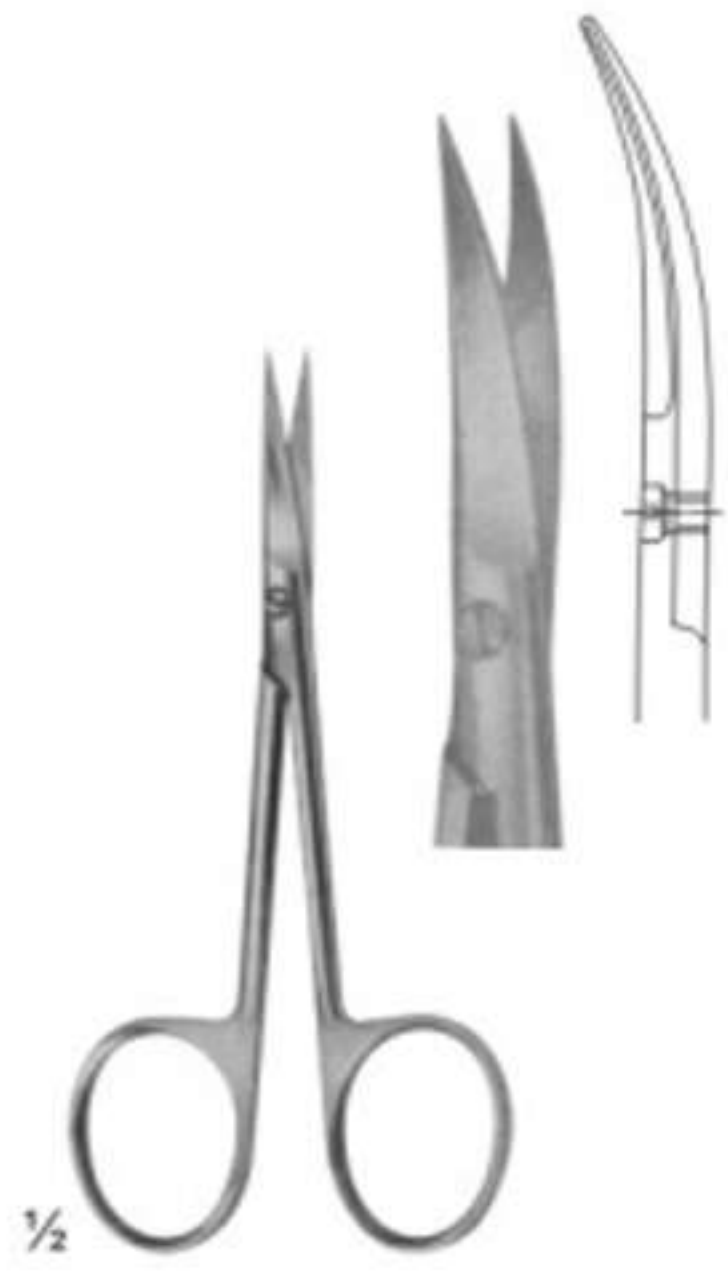

DMI-1-1231
Size: 95 mm

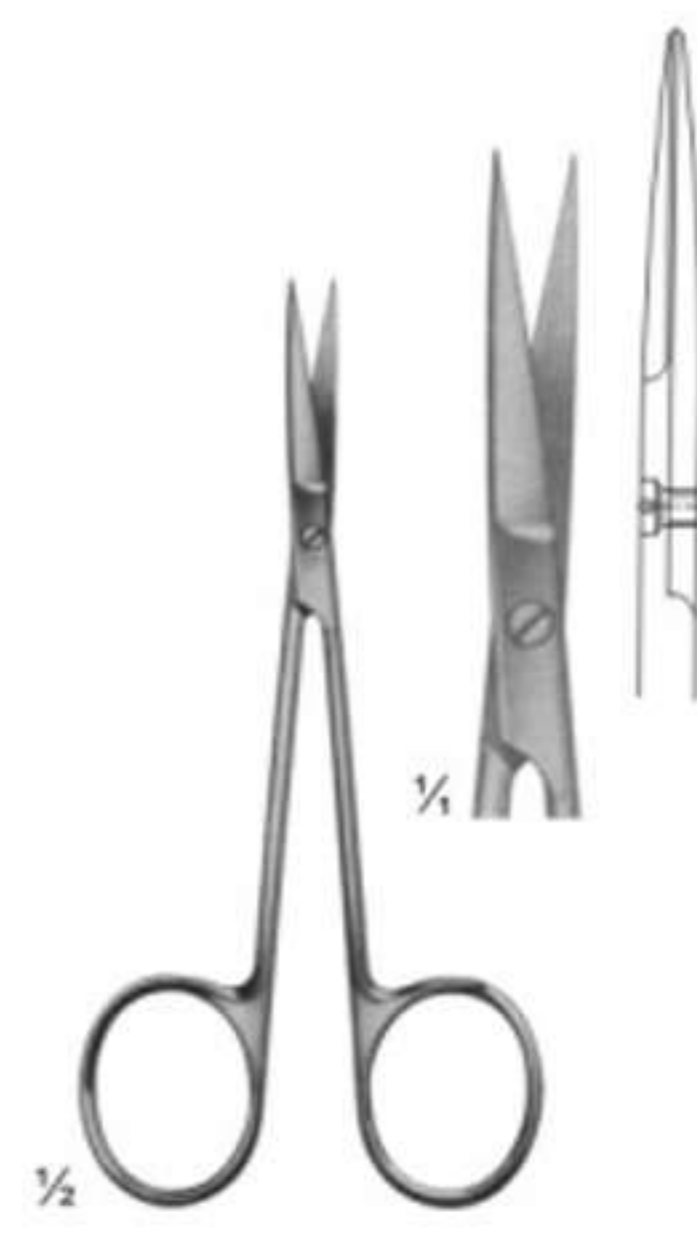

DMI-1-1232
Size: 105 mm



DMI-1-1233
Size: 105 mm

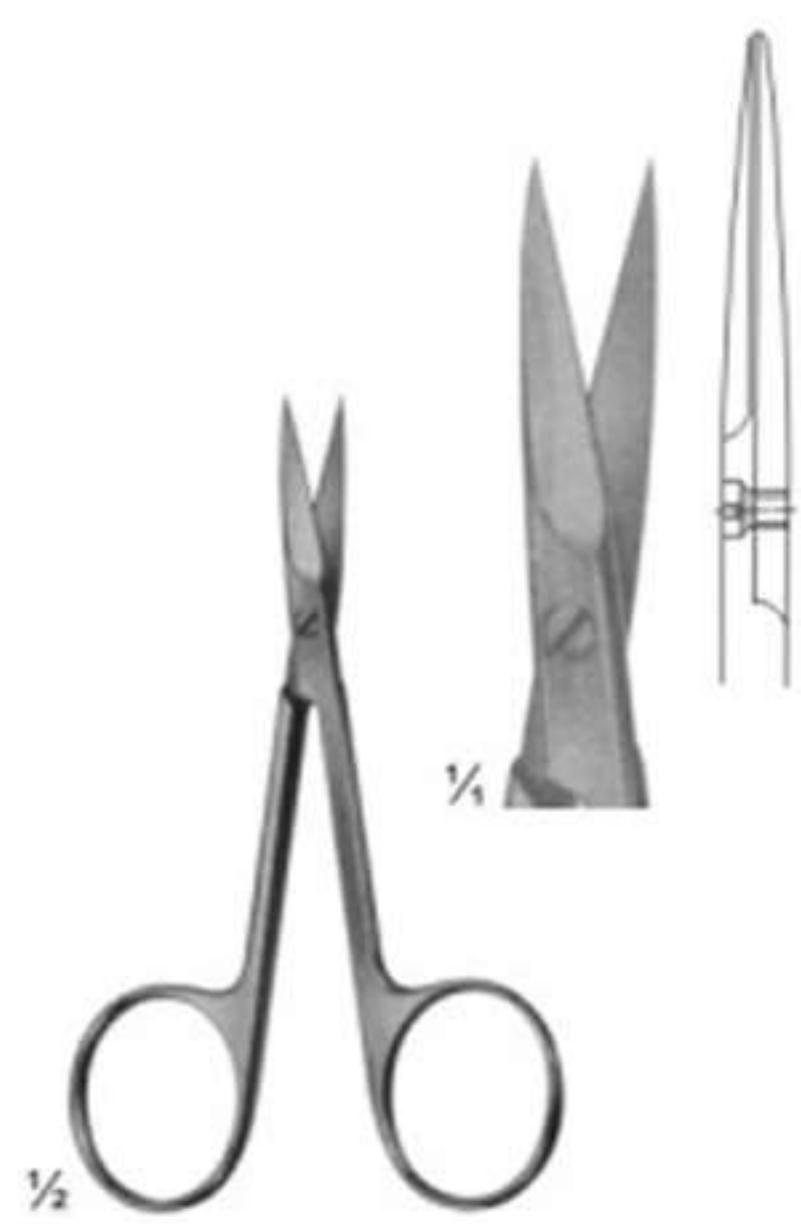

DMI-1-1234
Size: 120 mm

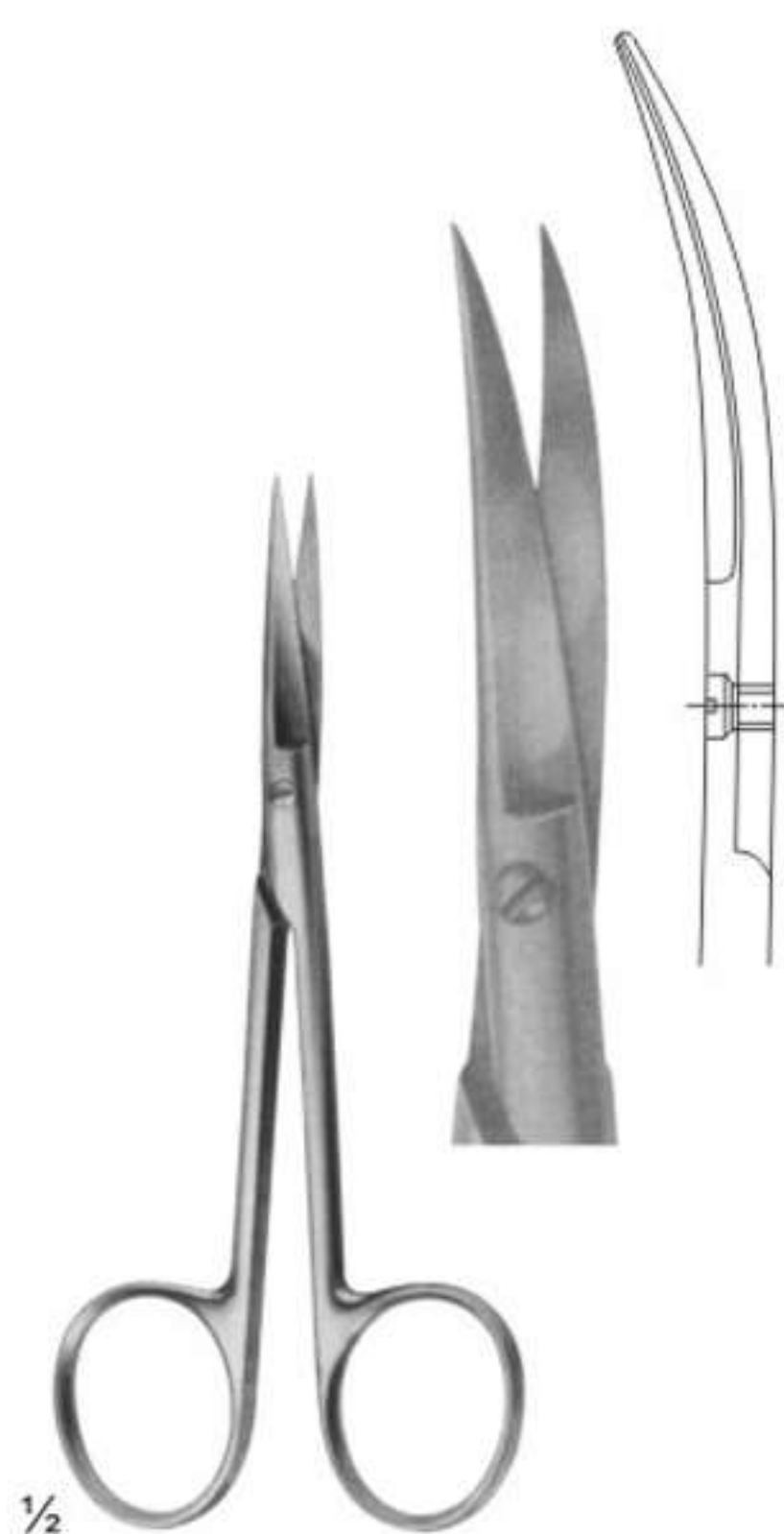

DMI-1-1235
Size: 90 mm

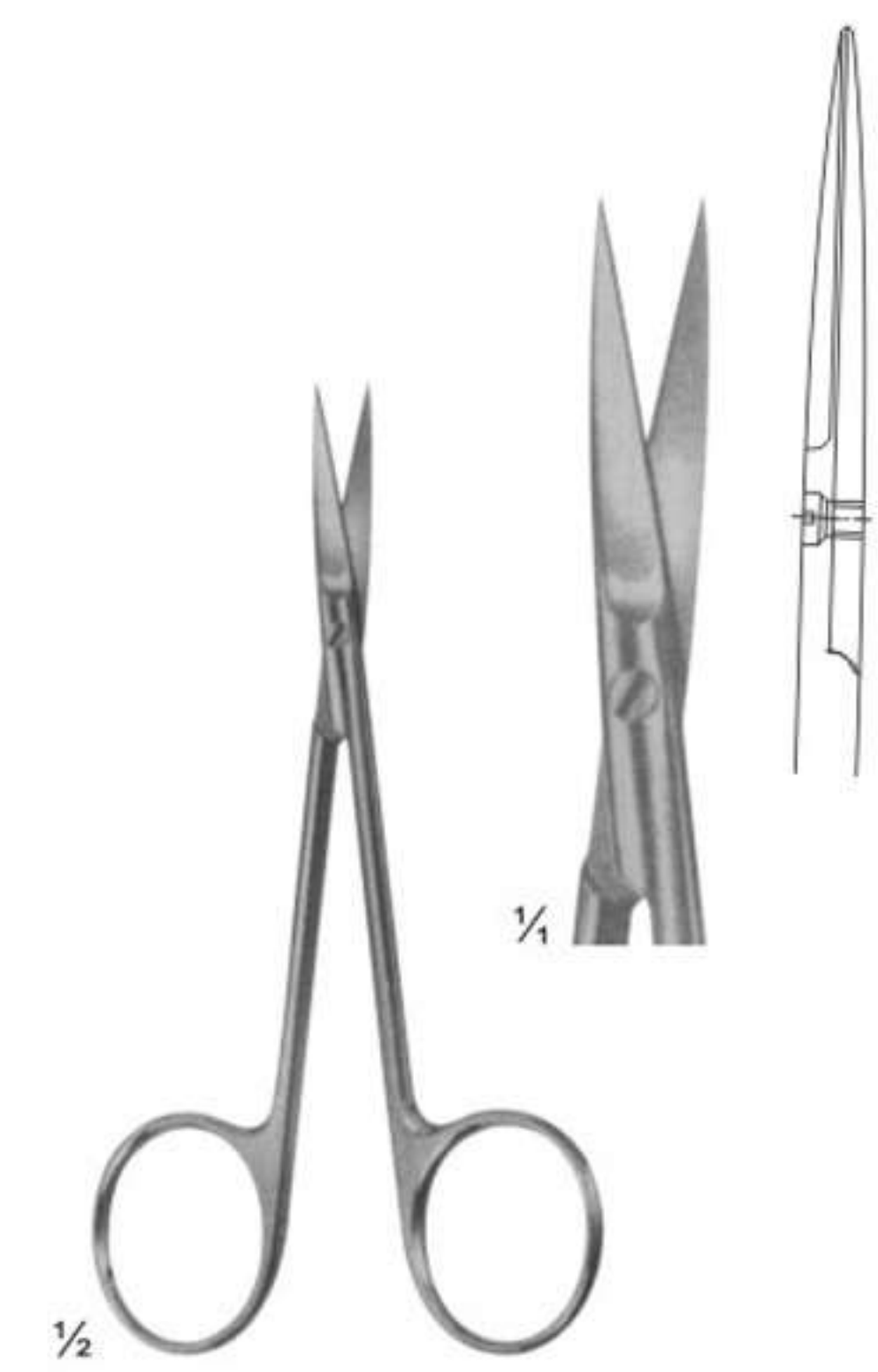

DMI-1-1236
Size: 115 mm

Scissors



DMI-1-1237
Size: 115 mm

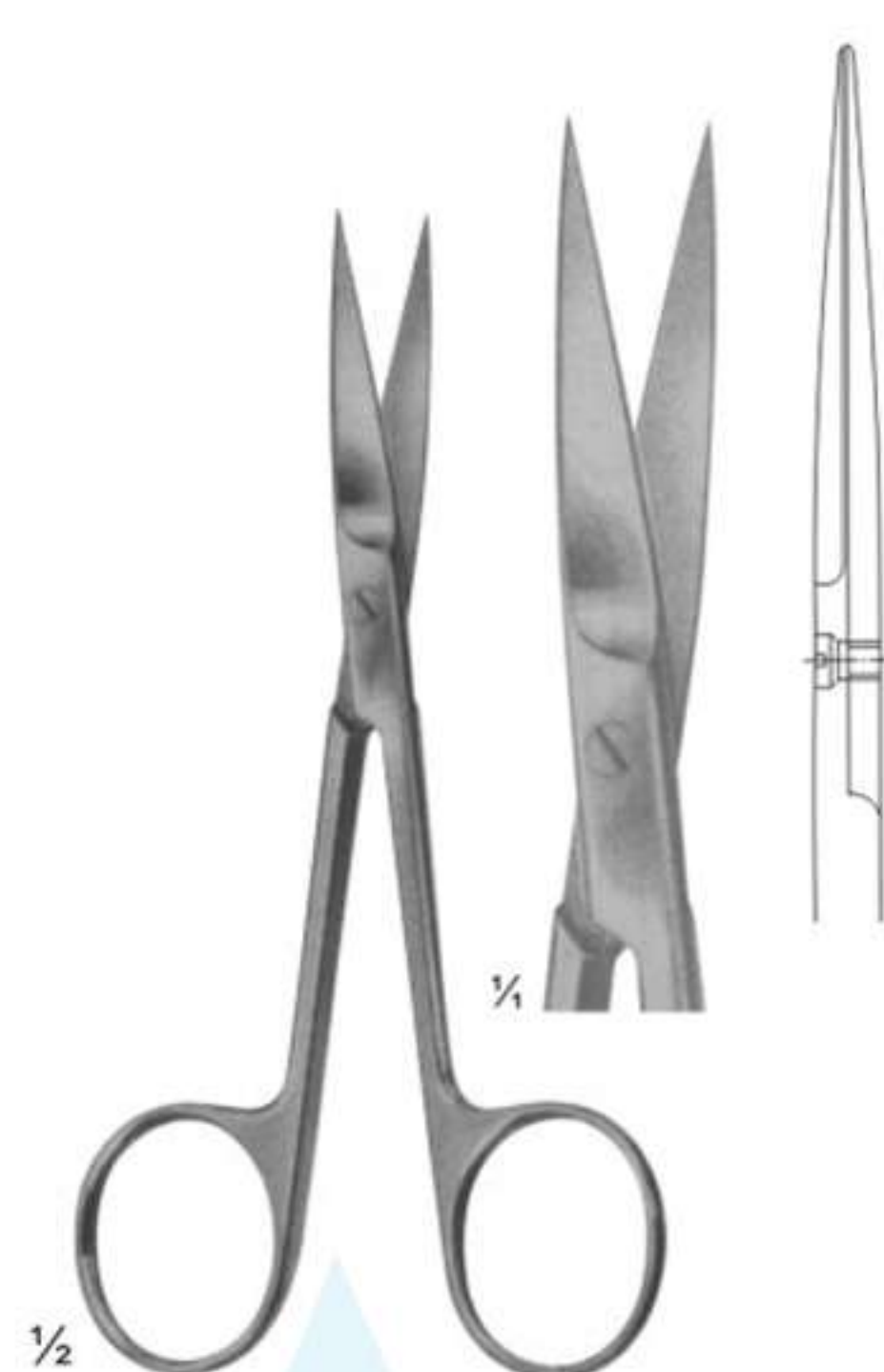

DMI-1-1238
Size: 120 mm

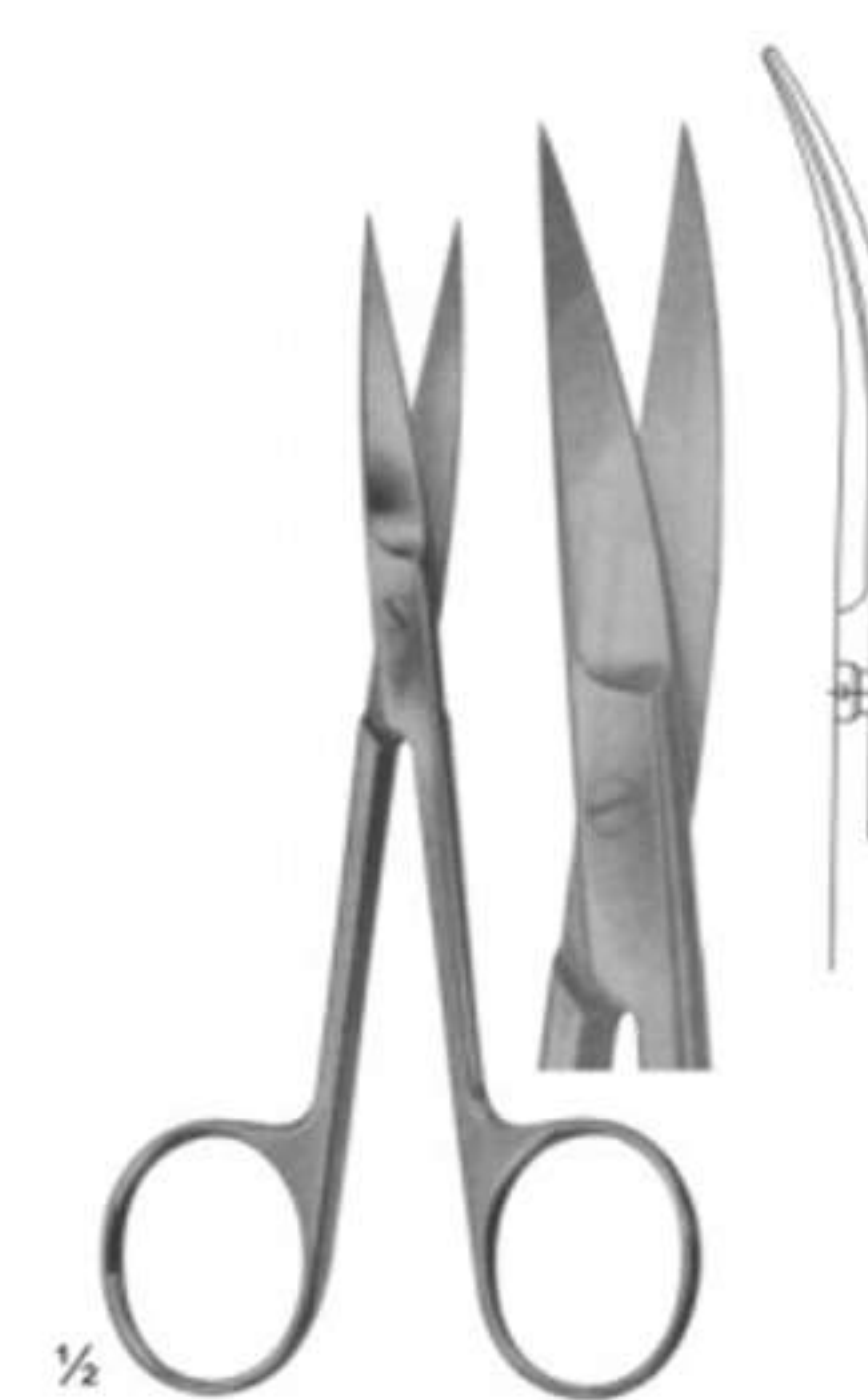

DMI-1-1239
Size: 120 mm

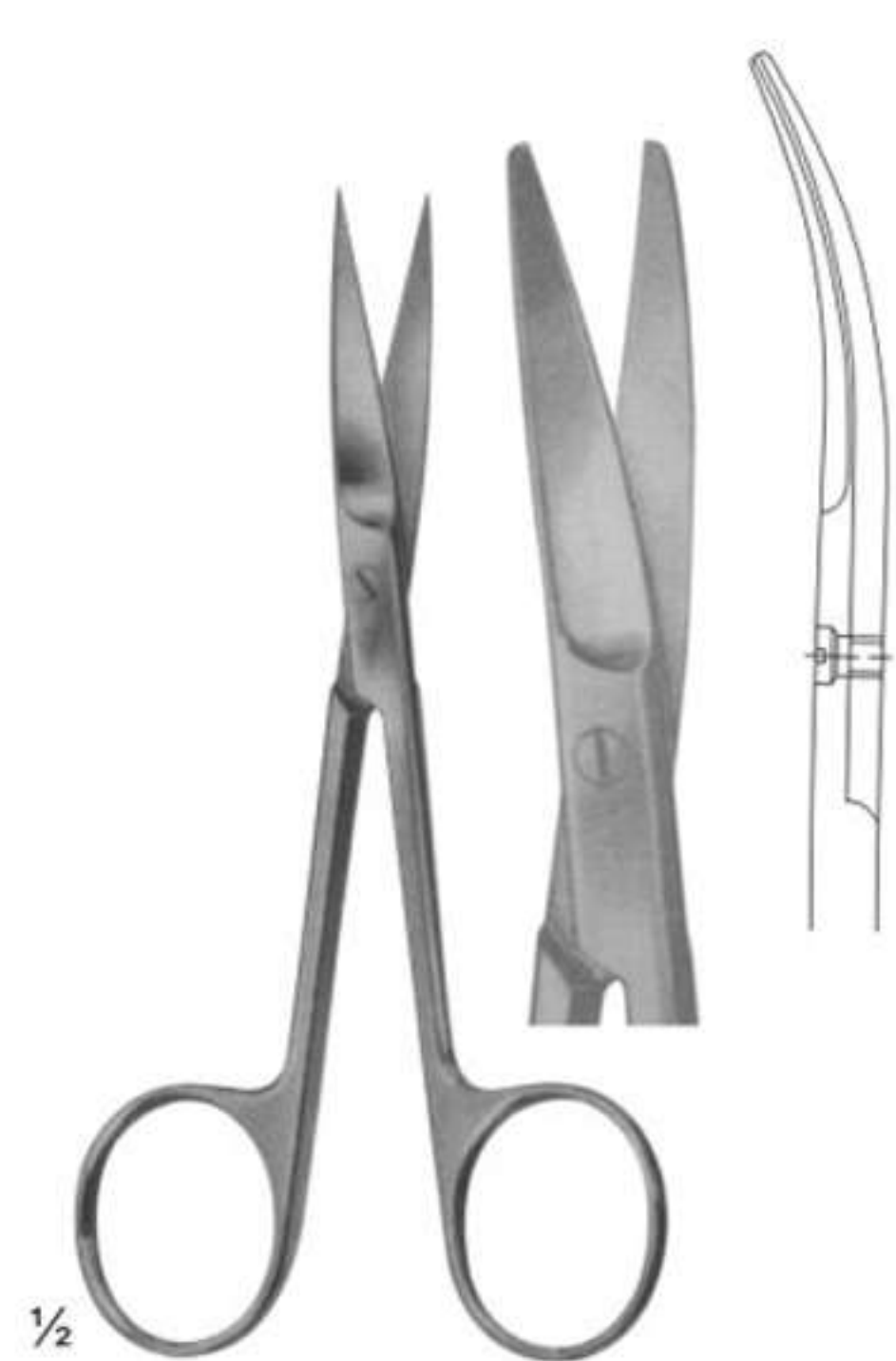

DMI-1-1240
Size: 120 mm

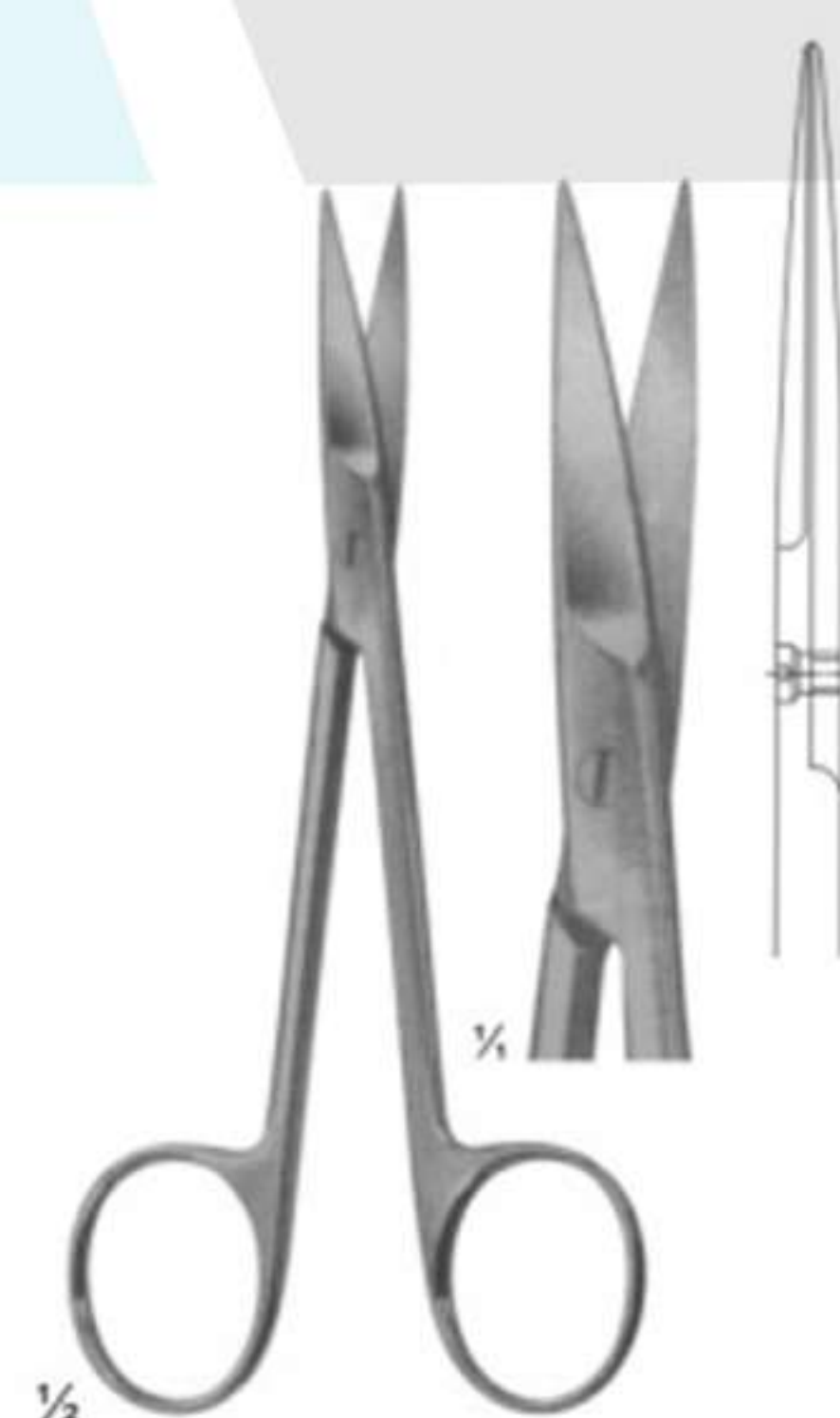

DMI-1-1241
Size: 130 mm

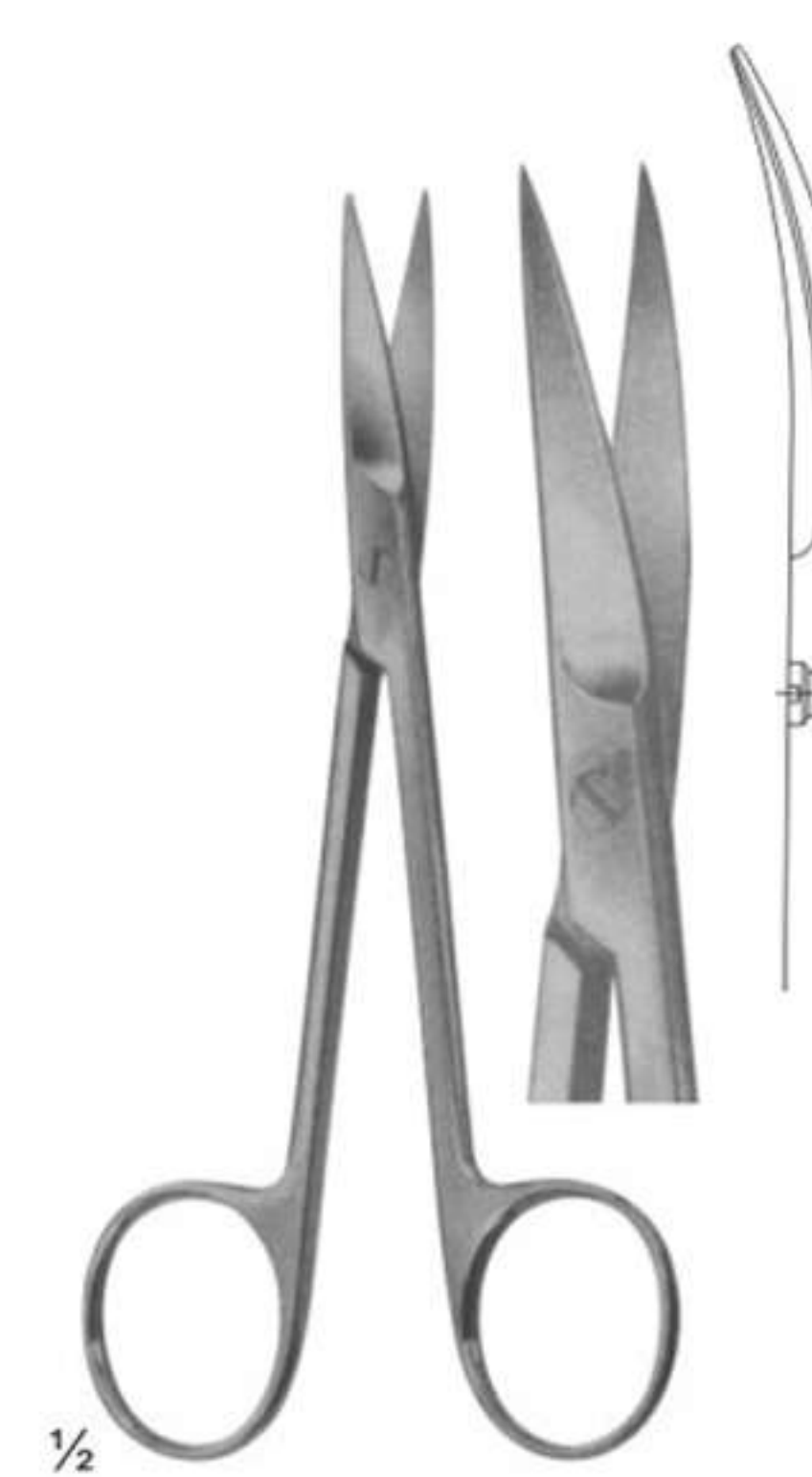

DMI-1-1242
Size: 130 mm

Scissors



DMI-1-1243
Size: 130 mm

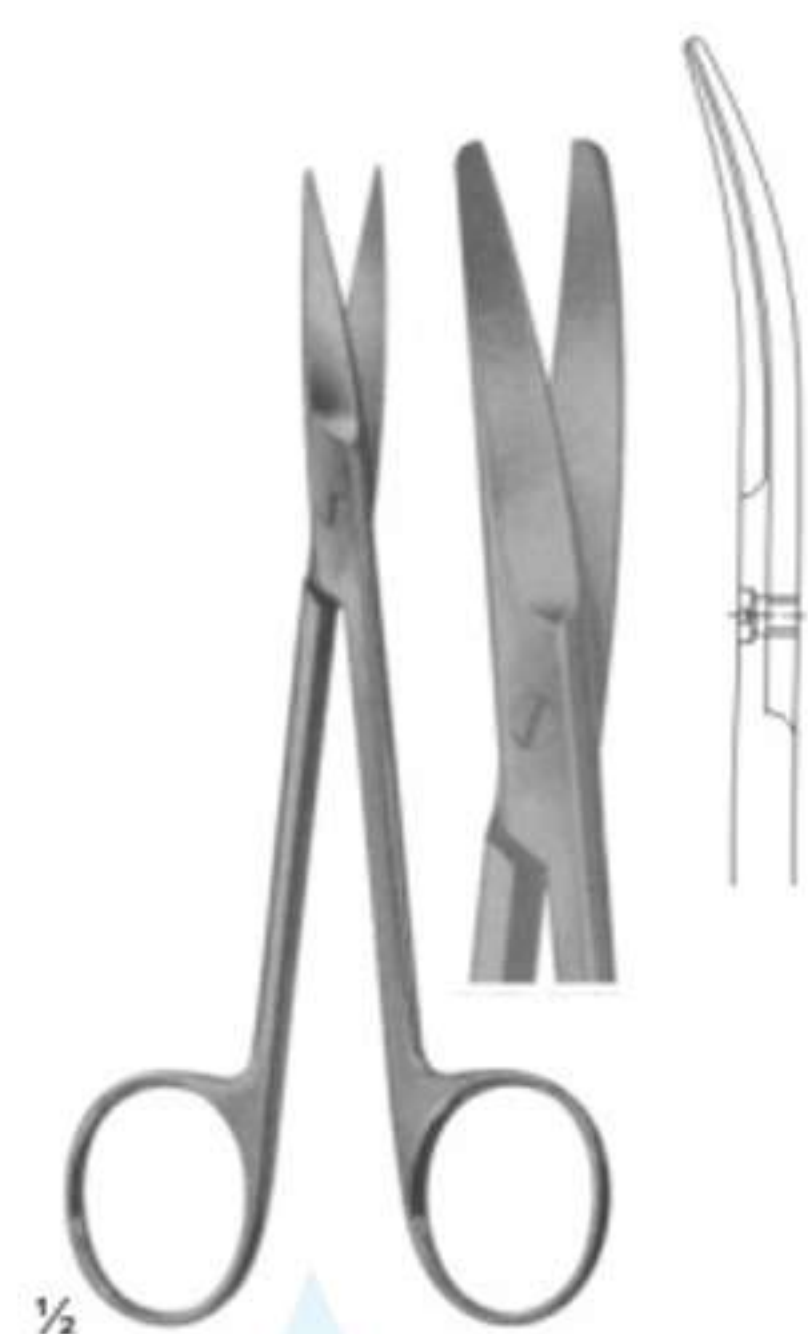

DMI-1-1244
Size: 130 mm

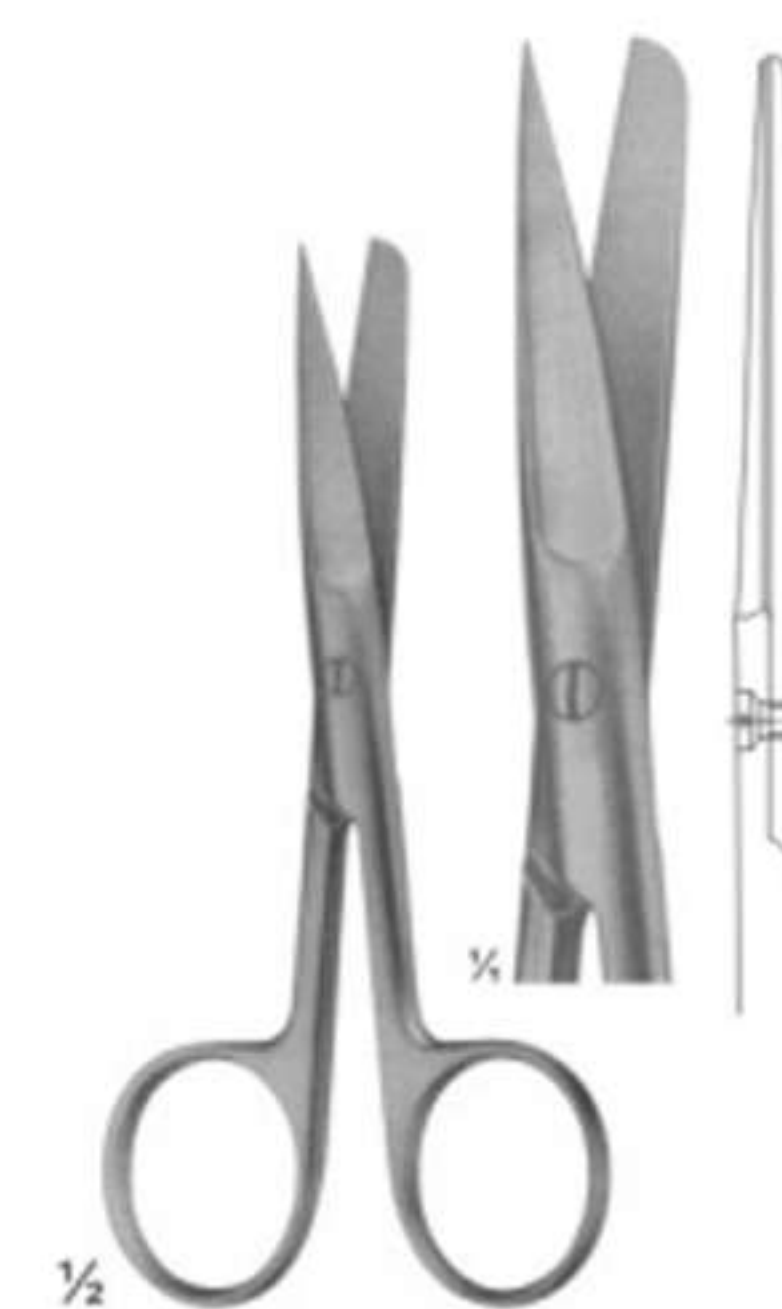

DMI-1-1245
105 mm

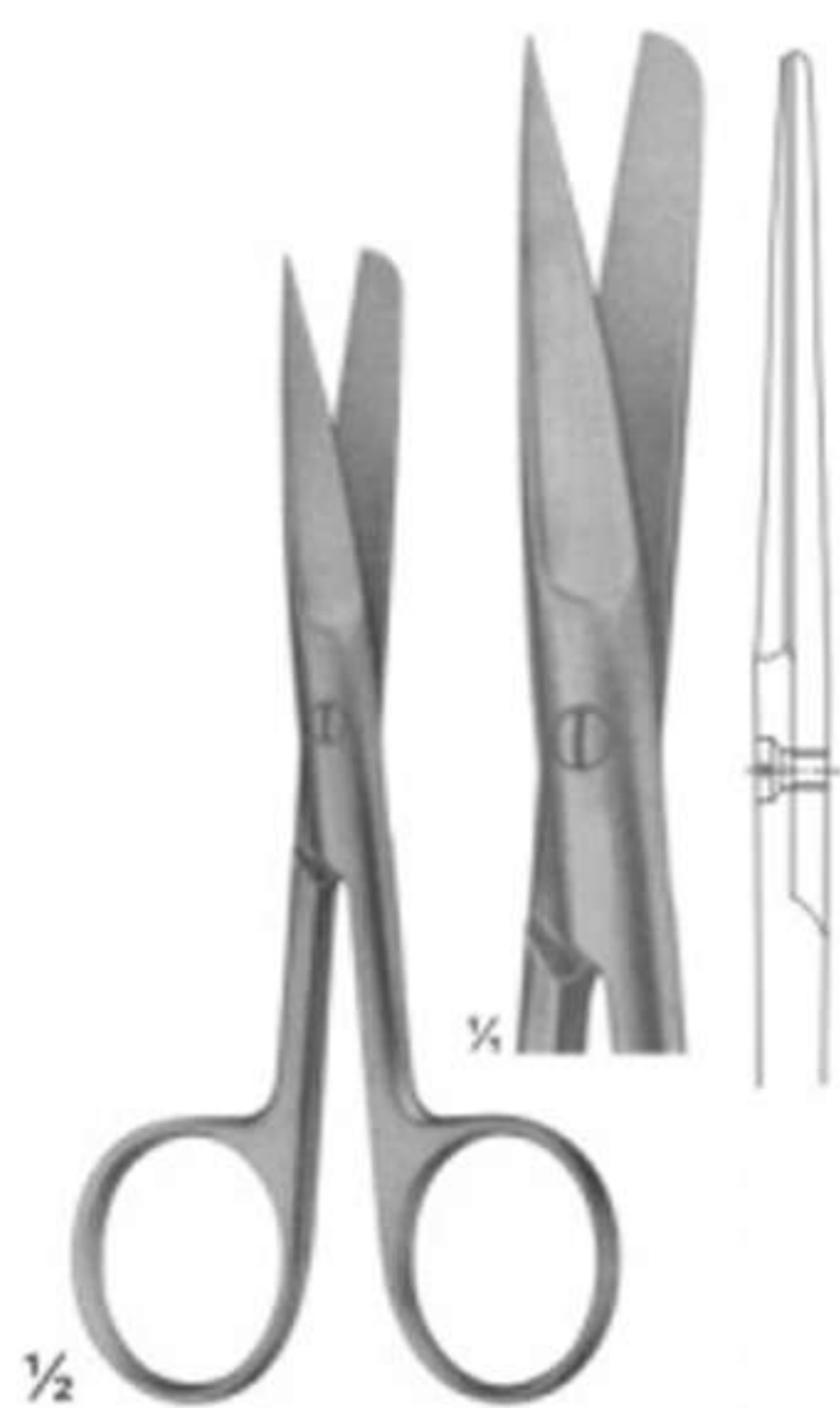
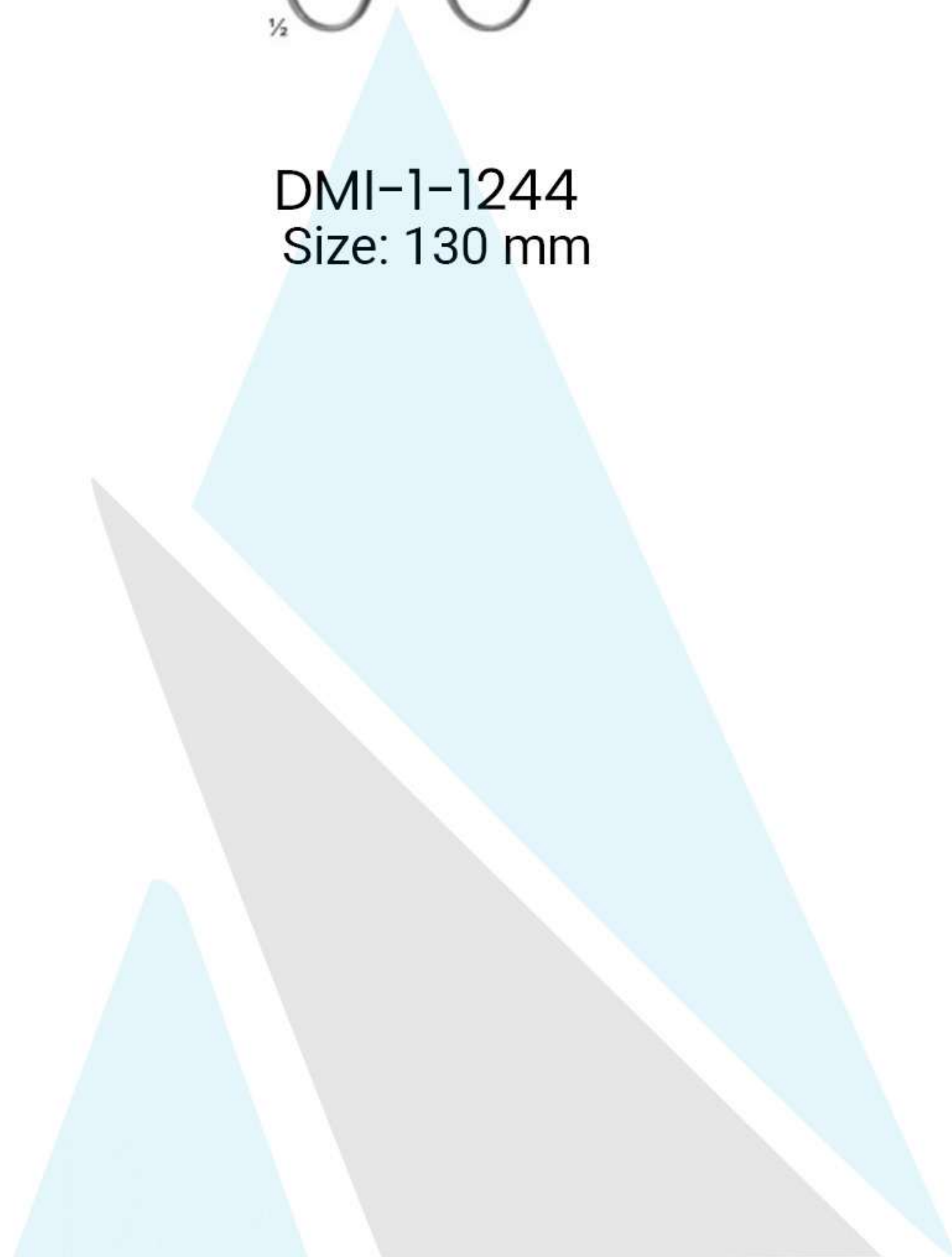

DMI-1-1246
115 mm

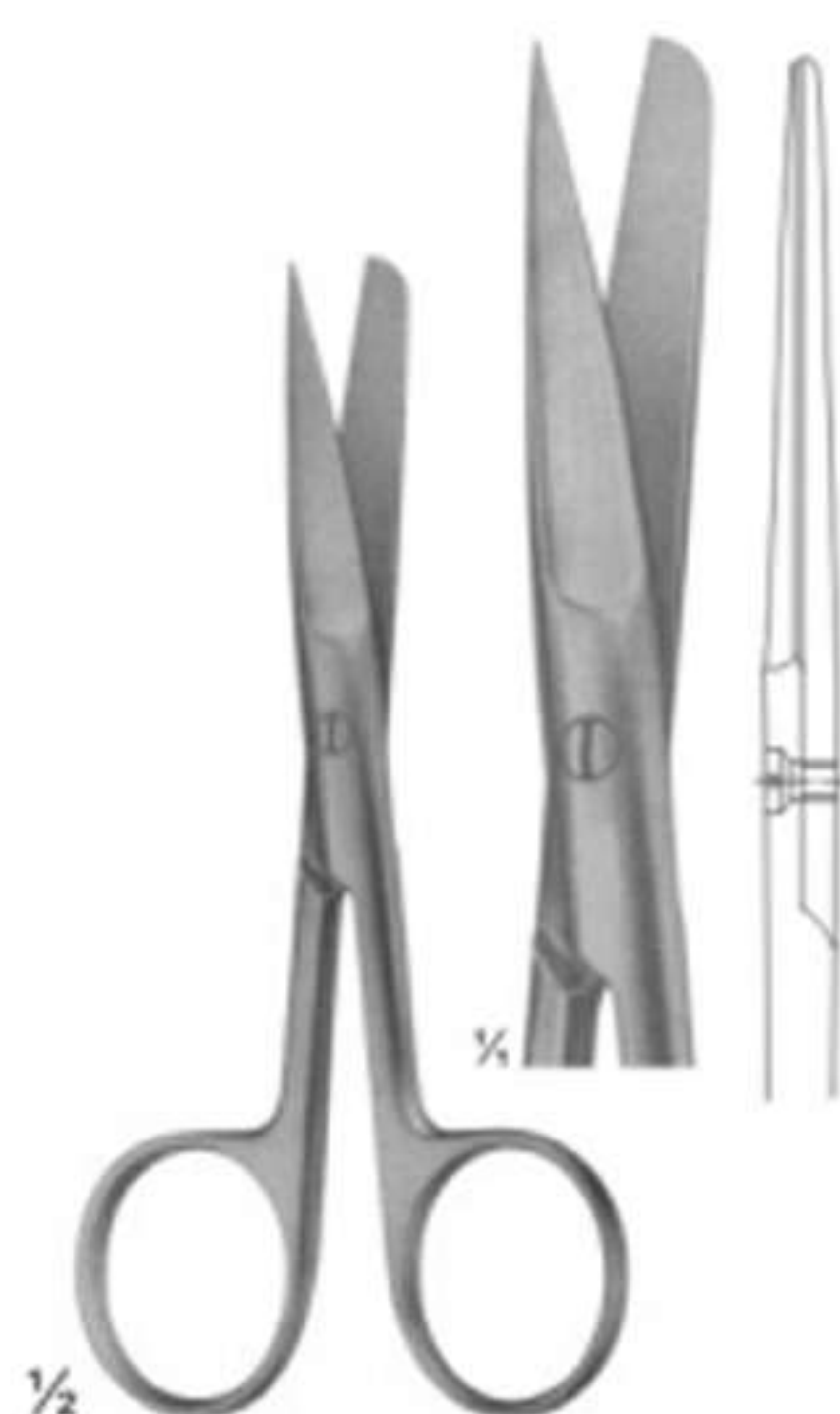

DMI-1-1247
130 mm



DMI-1-1248
145 mm

Scissors

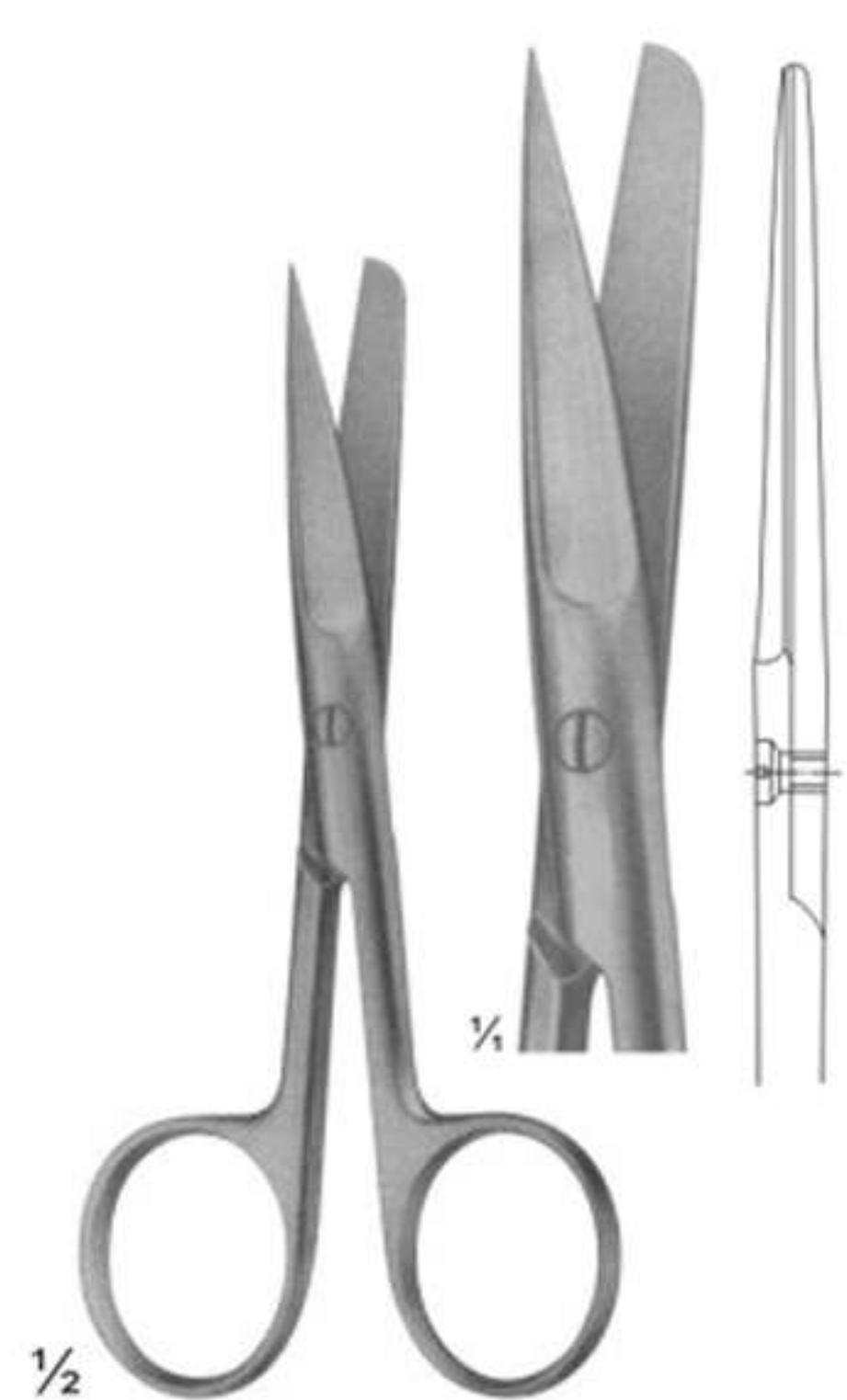

DMI-1-1249
150 mm

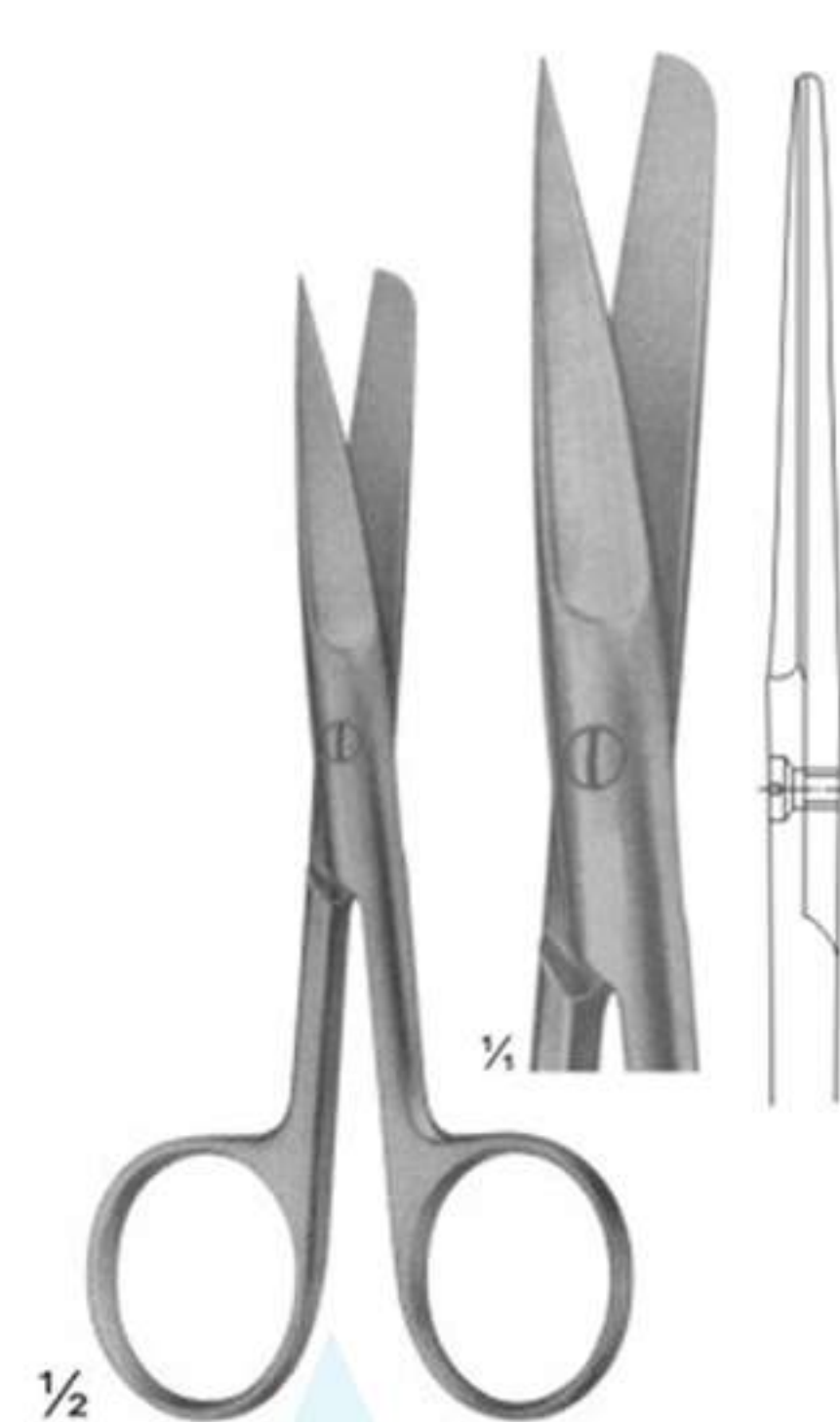

DMI-1-1250
165 mm

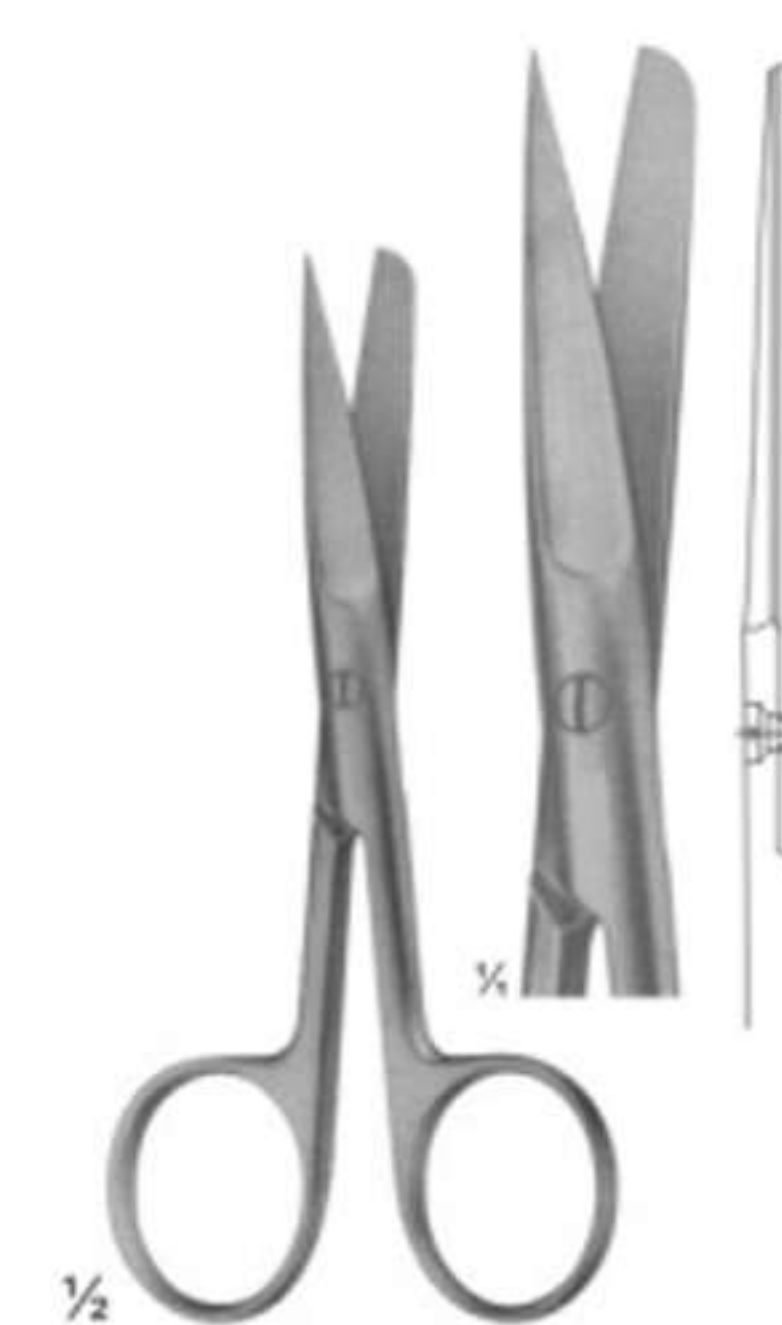

DMI-1-1251
175 mm

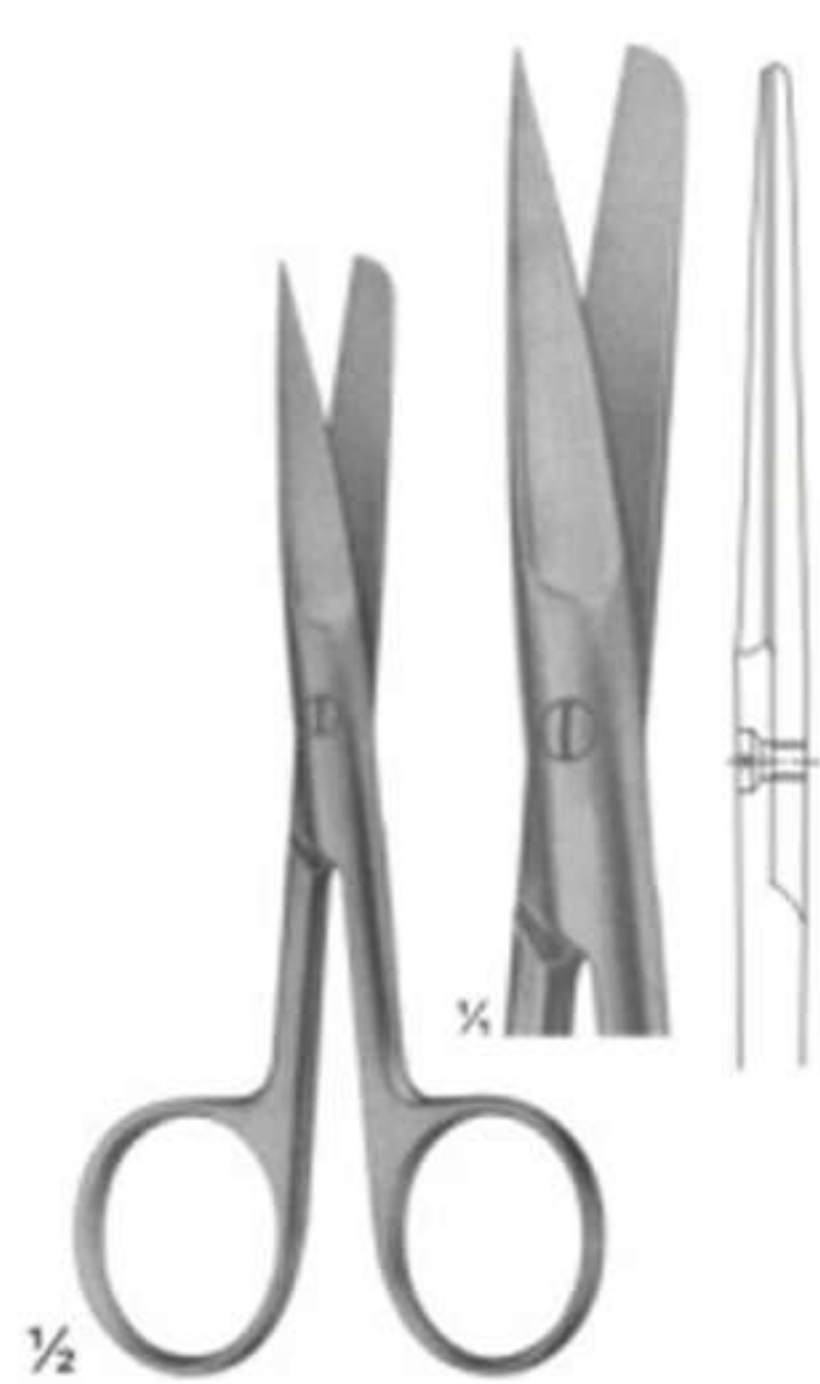

DMI-1-1252
115 mm

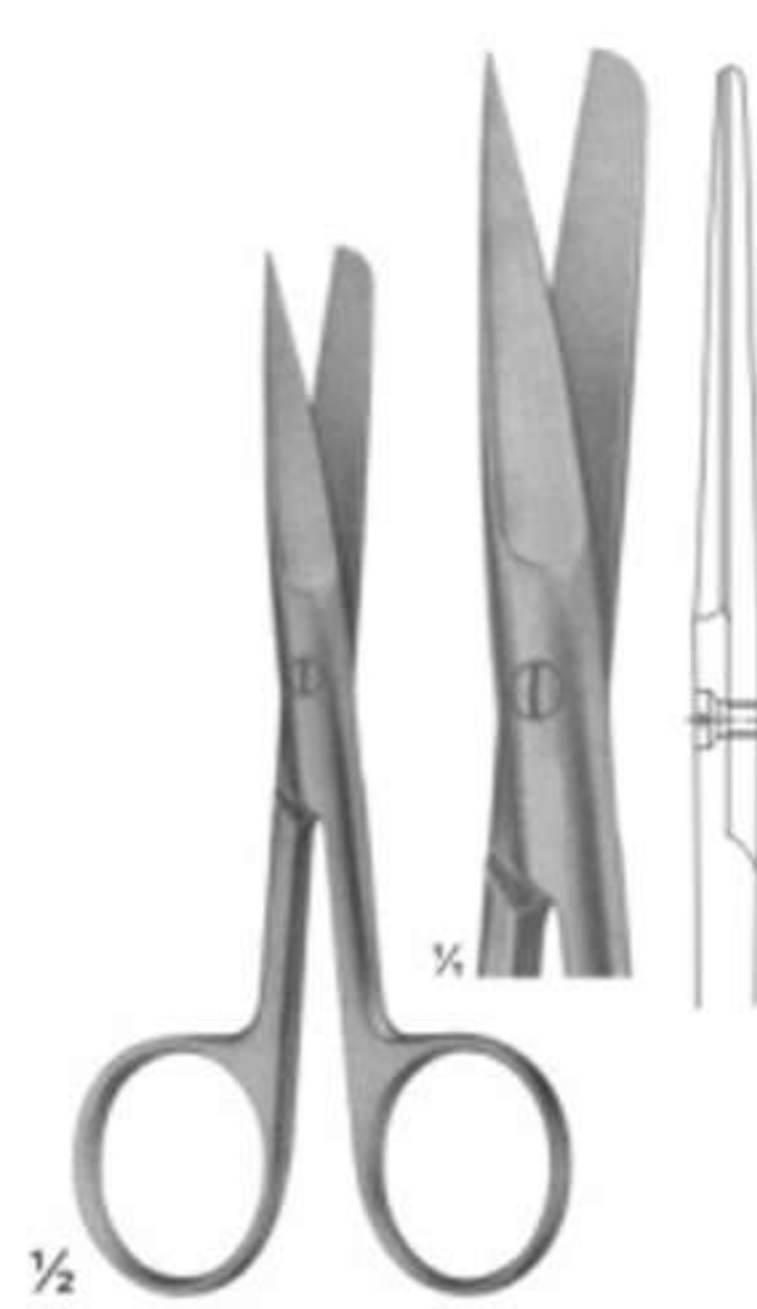

DMI-1-1253
200 mm

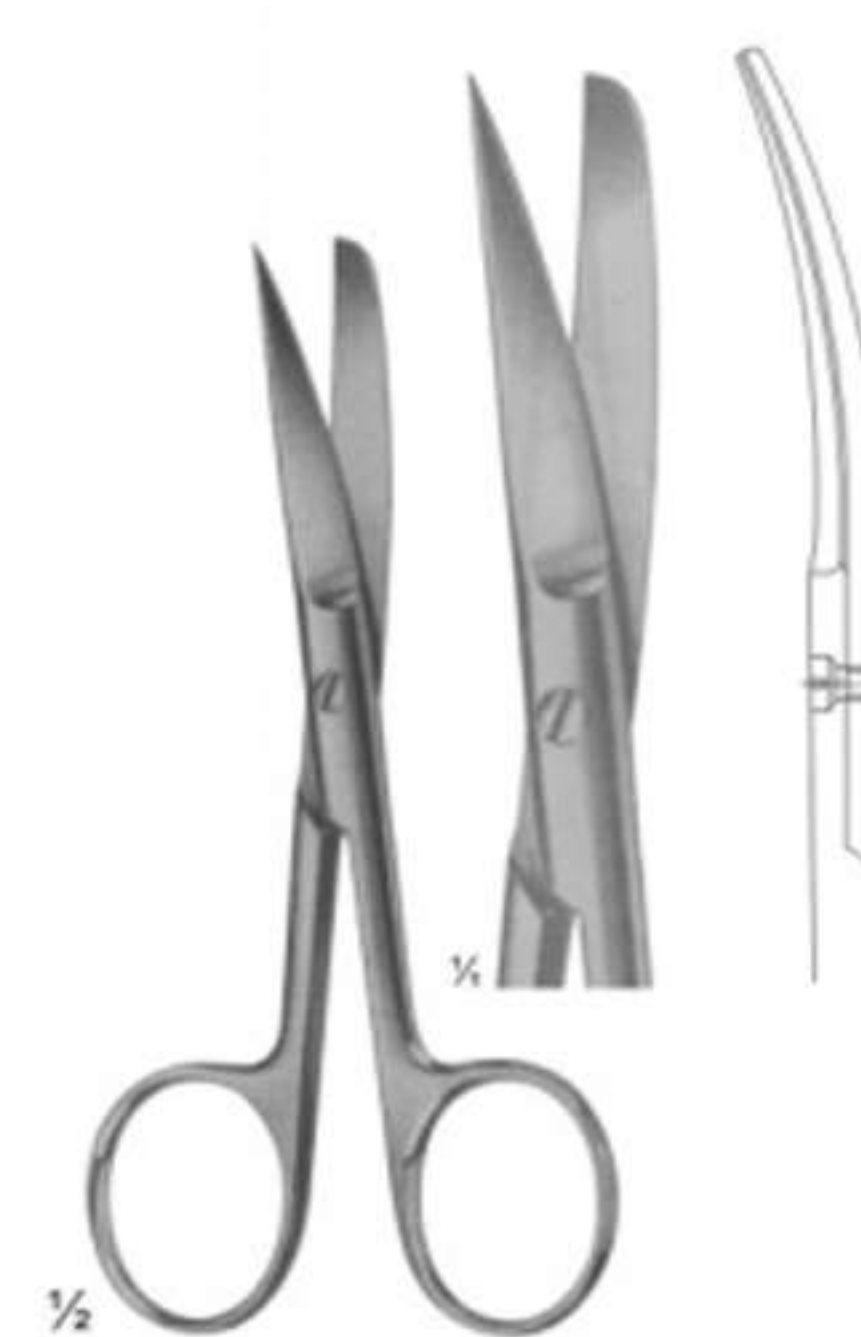

DMI-1-1254
115 mm

Scissors

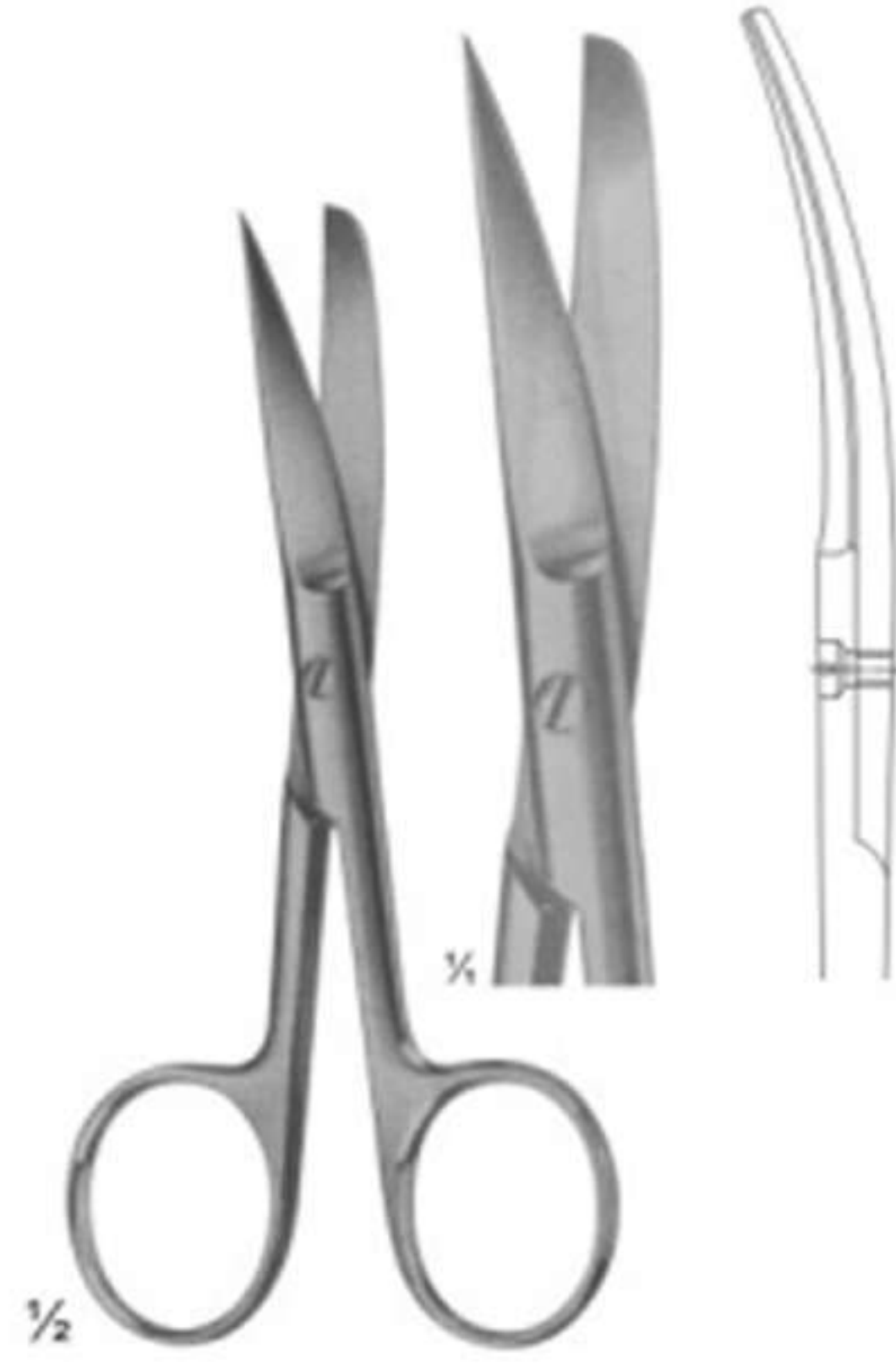

DMI-1-1255
130 mm

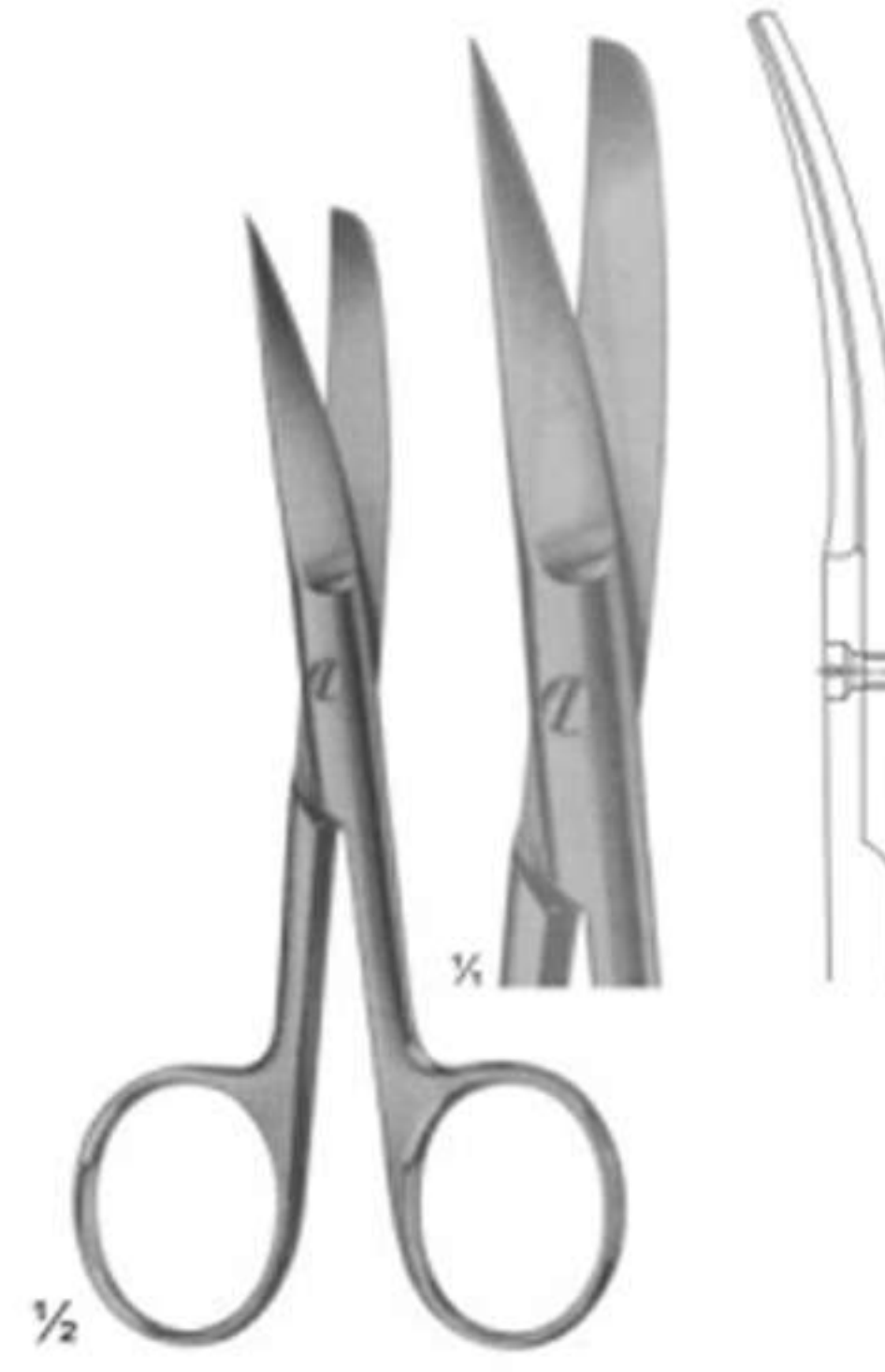

DMI-1-1256
145 mm

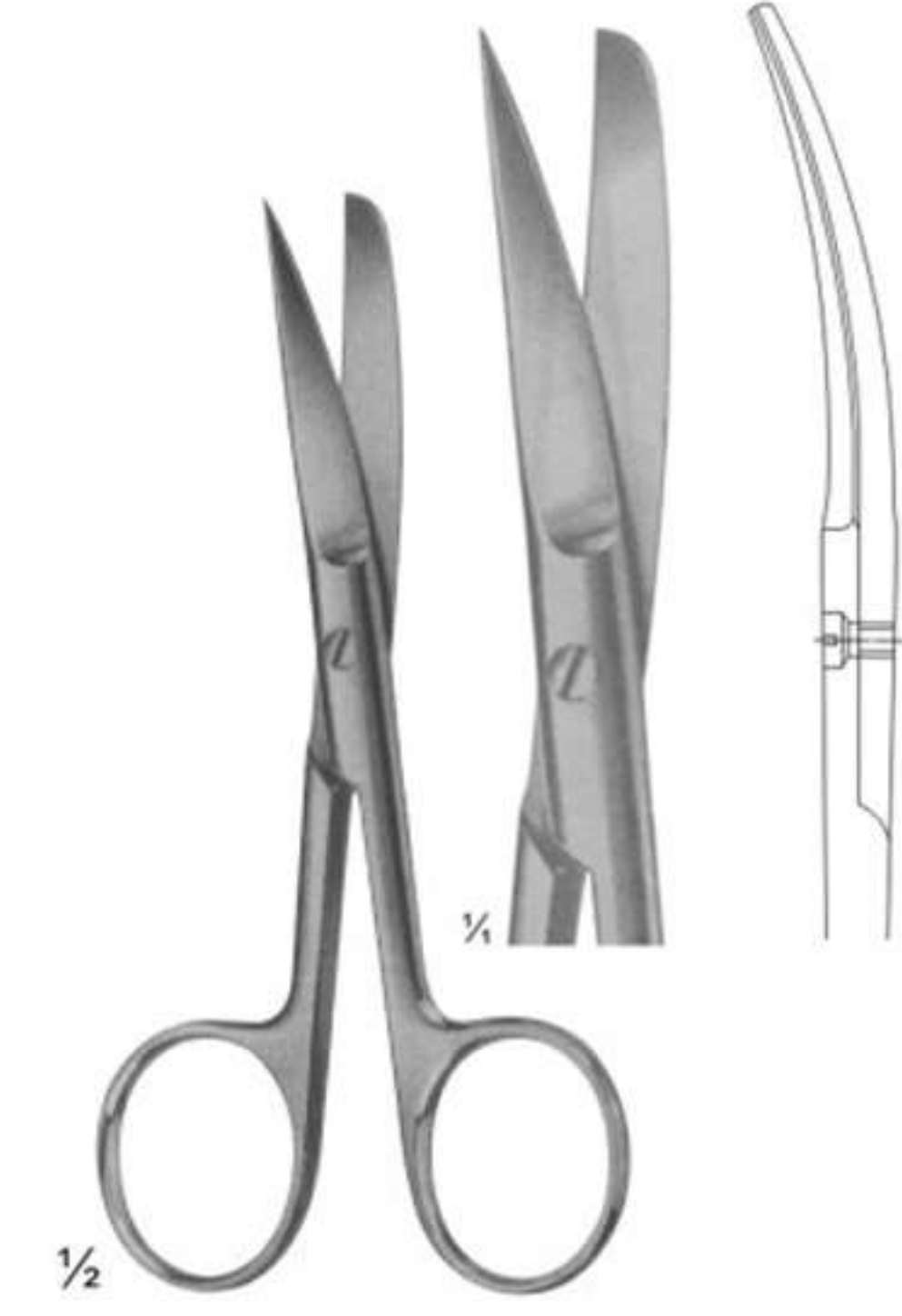

DMI-1-1257
150 mm

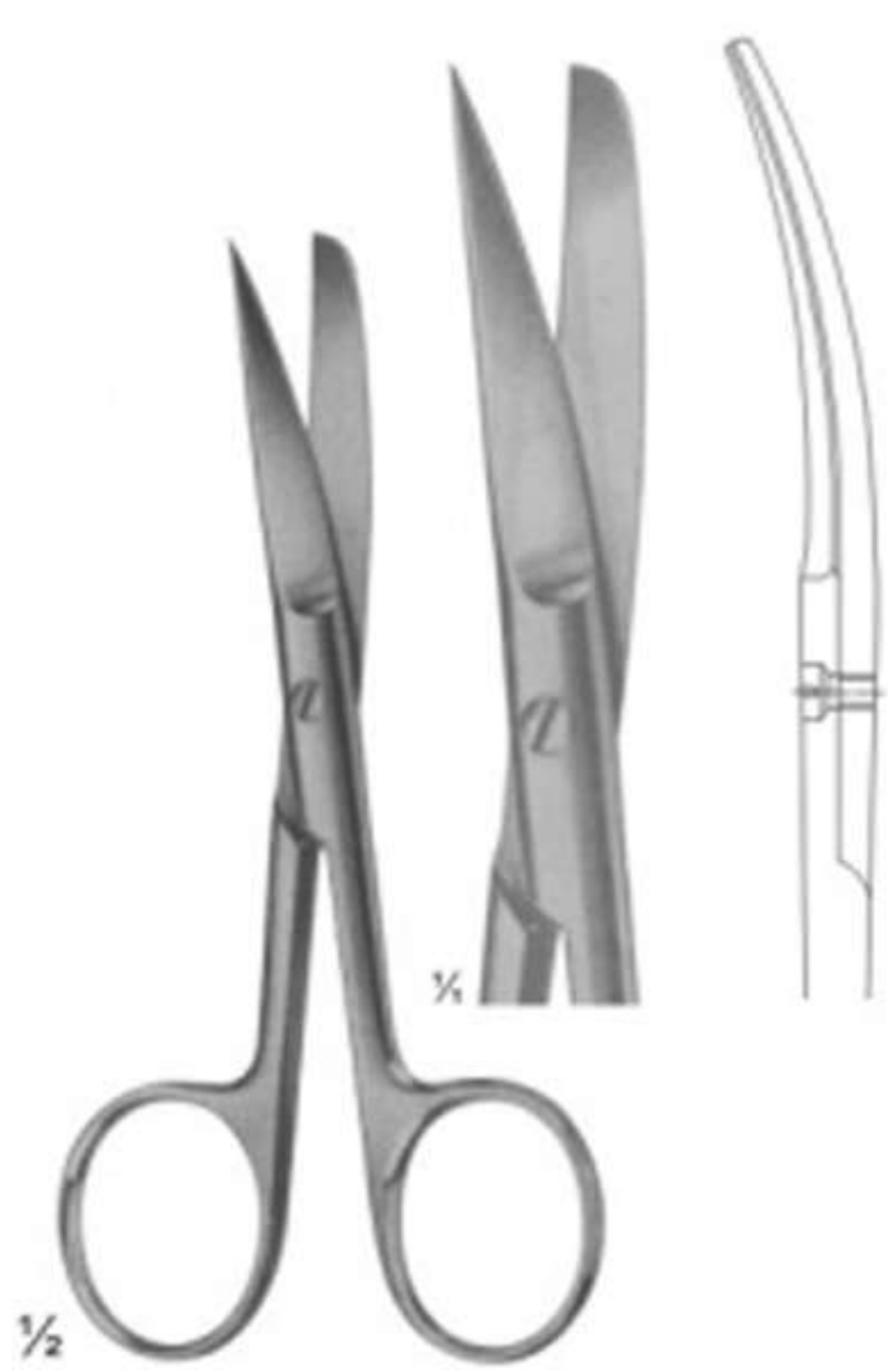
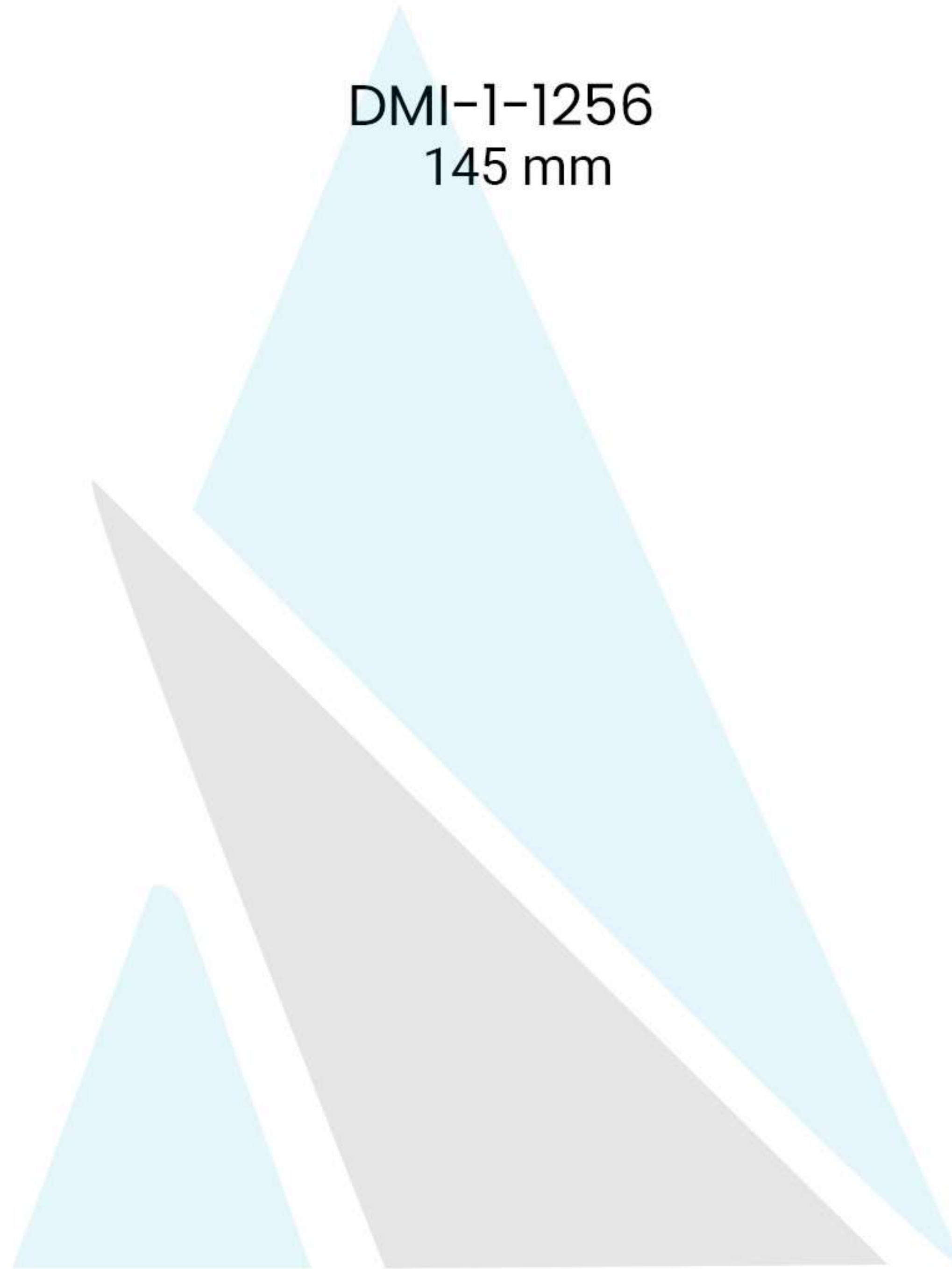

DMI-1-1258
165 mm

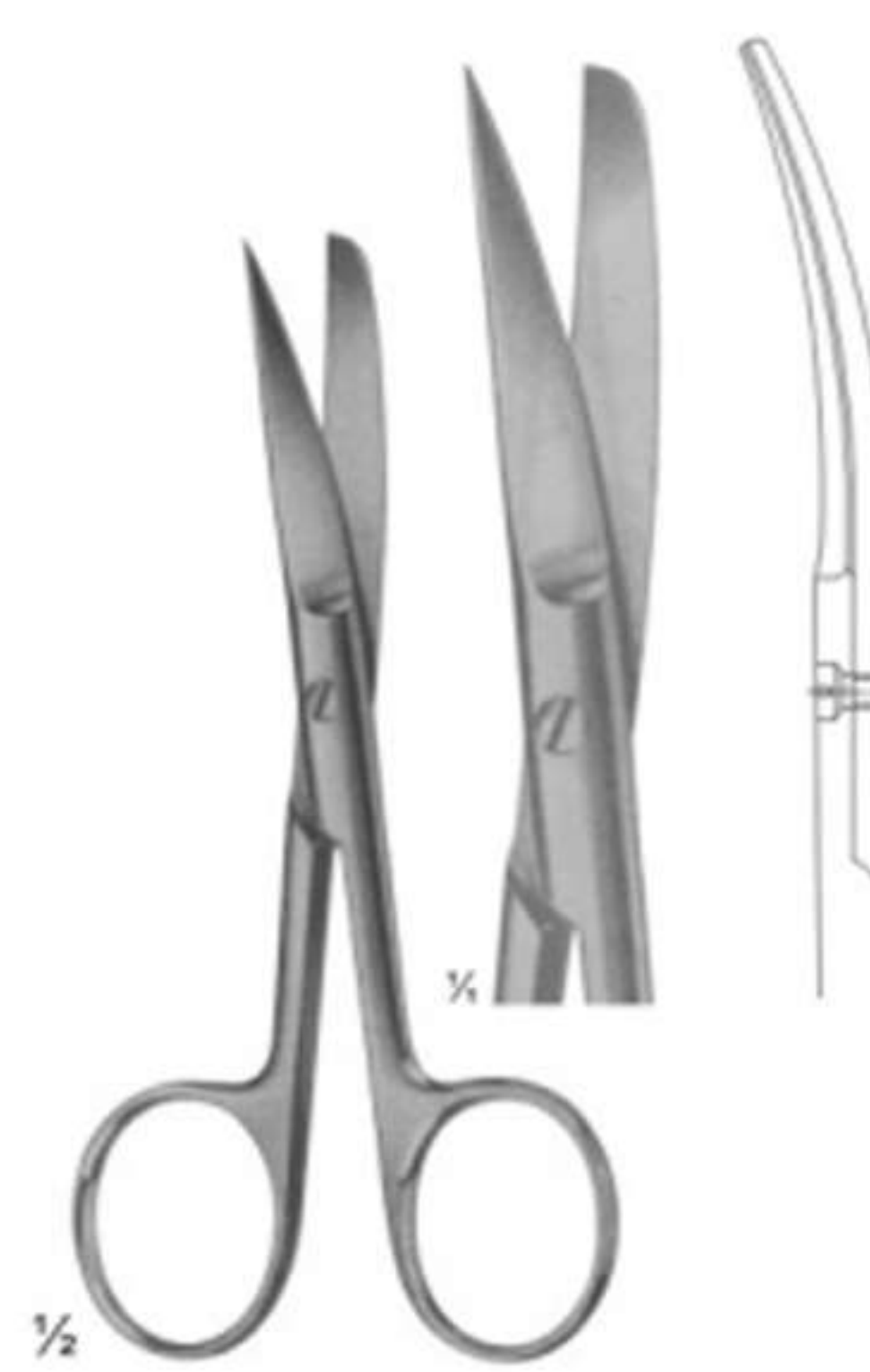

DMI-1-1259
175 mm

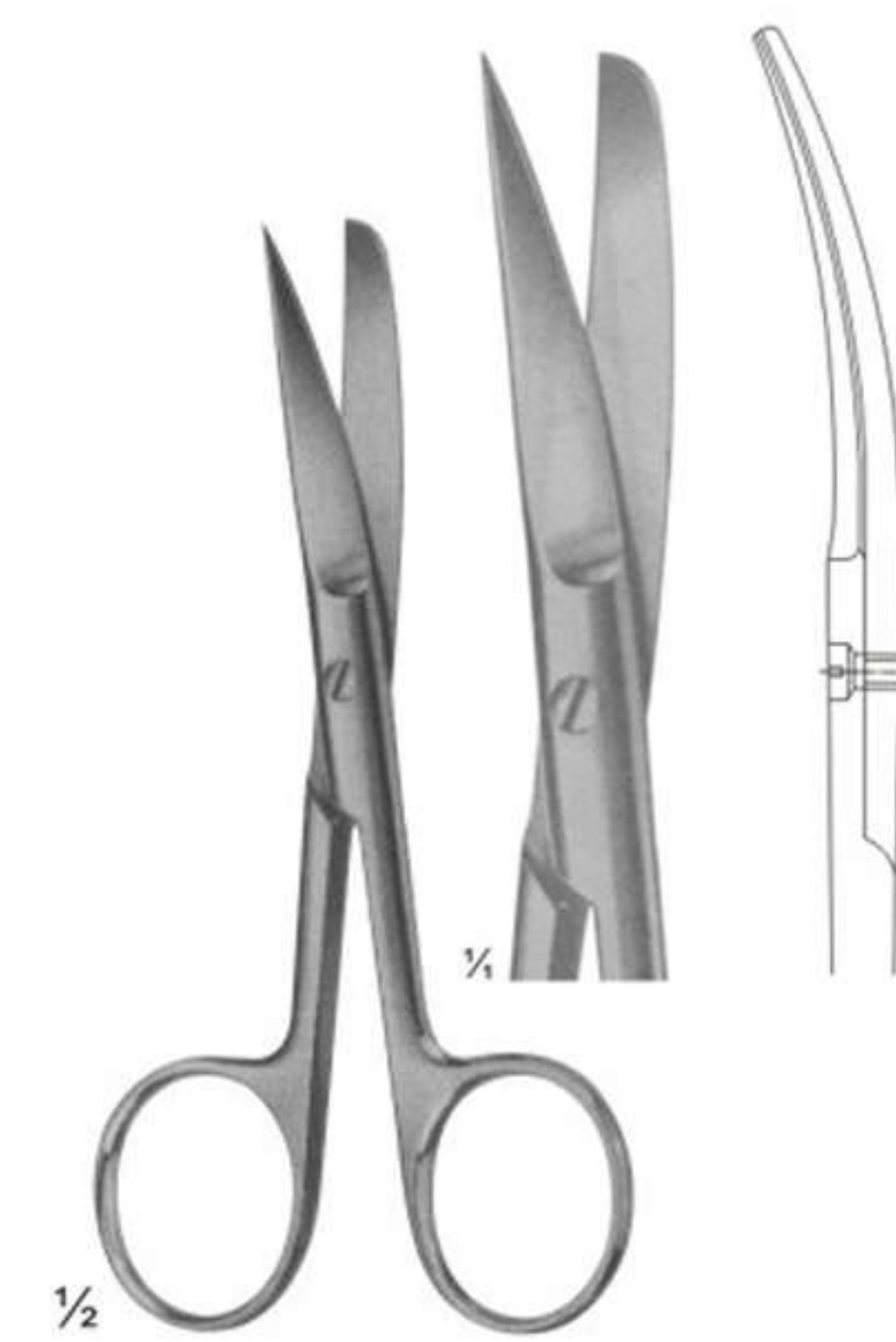

DMI-1-1260
185 mm

Scissors



DMI-1-1261
Universal bandage and cloth
scissors, with toothed edges
180 mm



DMI-1-1262
LISTER Universal bandage and
cloth scissors, with toothed edges
Size: 145 mm



DMI-1-1263
LISTER Nurse's scissors
Size: 145 mm



DMI-1-1264
115 mm



DMI-1-1265
LISTER 140 mm



DMI-1-1266
LISTER 180 mm

Scissors



DMI-1-1267
LISTER 200 mm



DMI-1-1268
LISTER 155 mm



DMI-1-1269
LISTER 180 mm



DMI-1-1270
CLOTH SCISSORS 205 mm

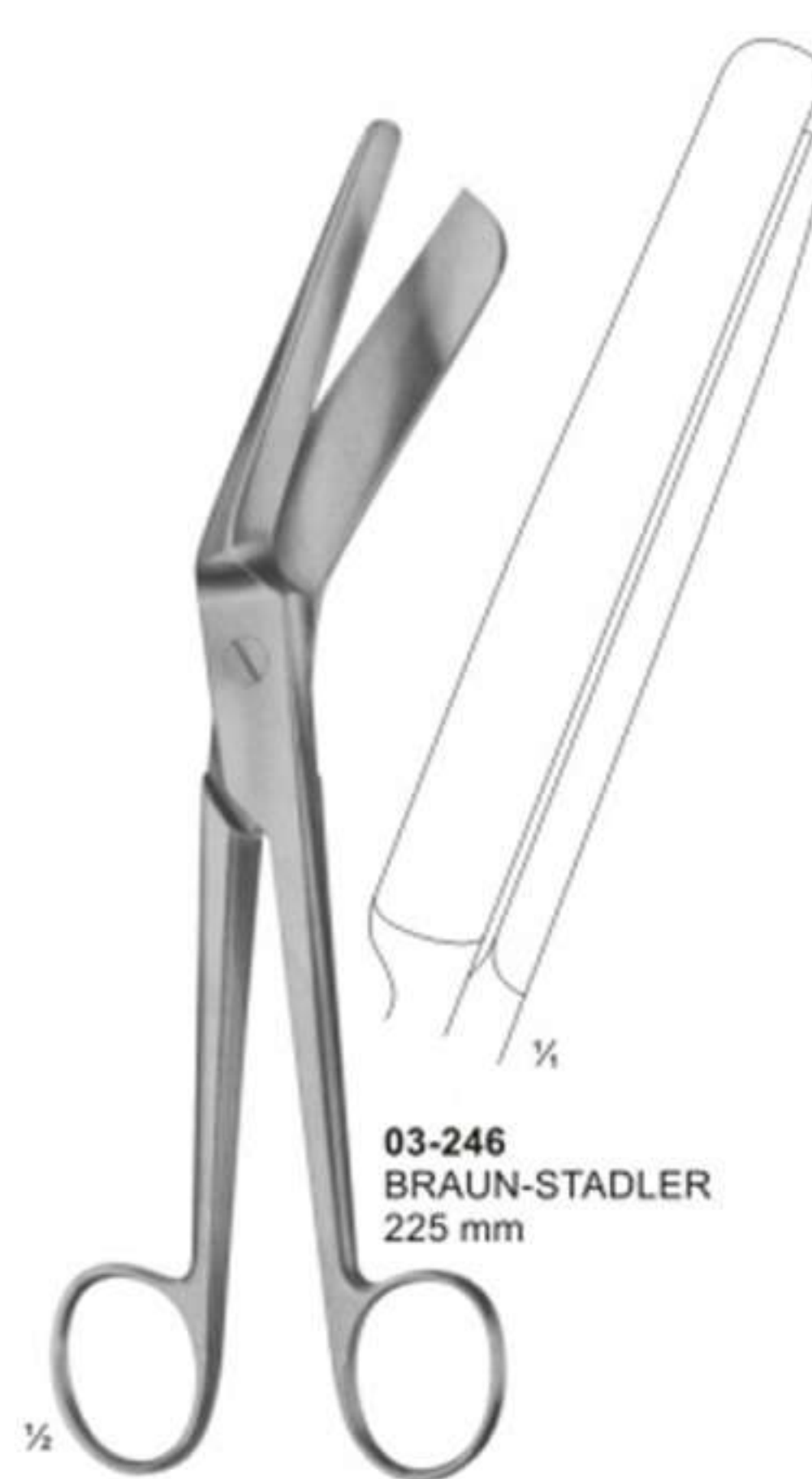

DMI-1-1271
BRAUN-STADLER 225 mm



DMI-1-1272
SEUTIN 230 mm

Scissors



DMI-1-1273
ESMARCH 200 mm

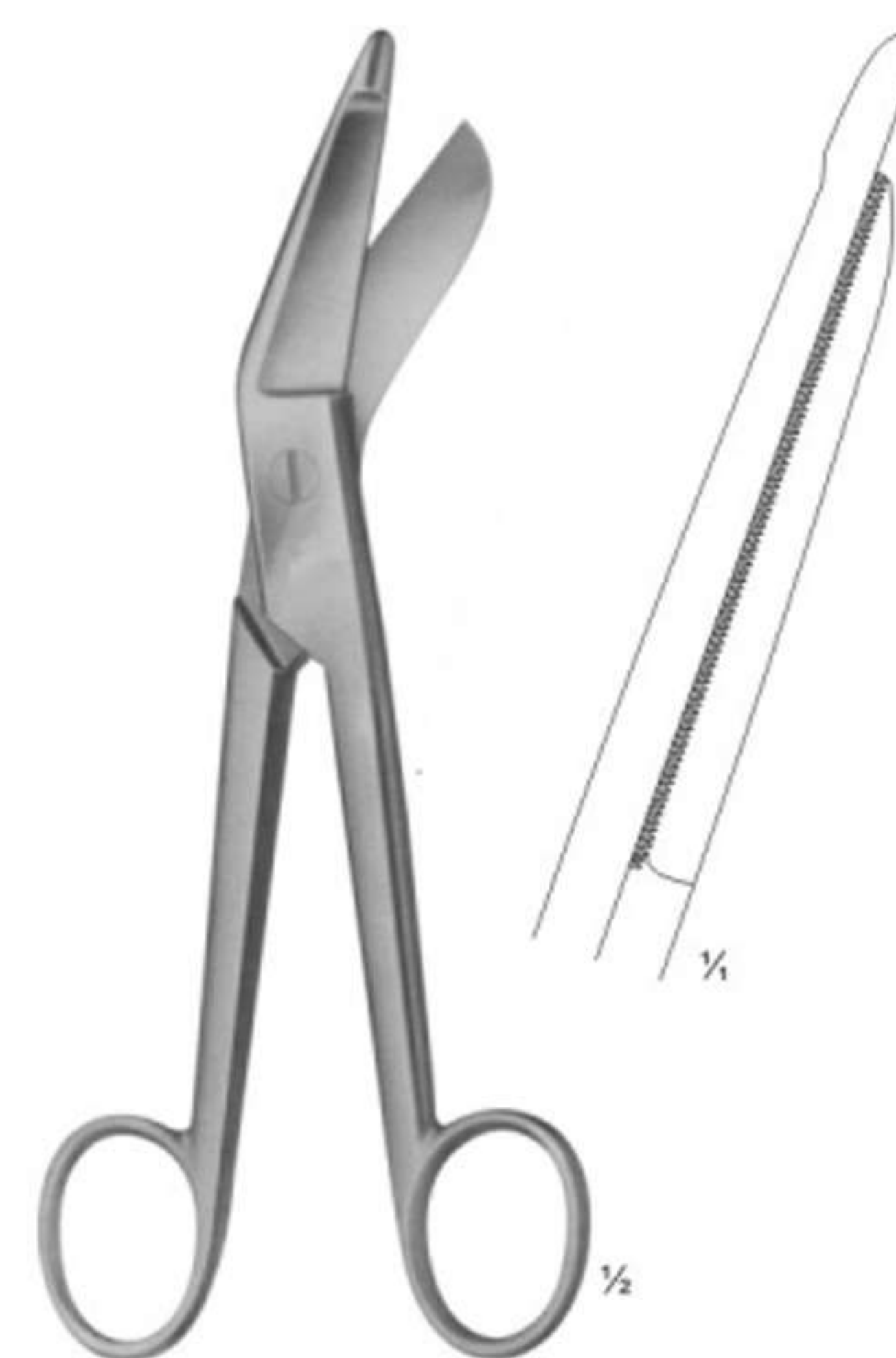

DMI-1-1274
BRUNS 235 mm

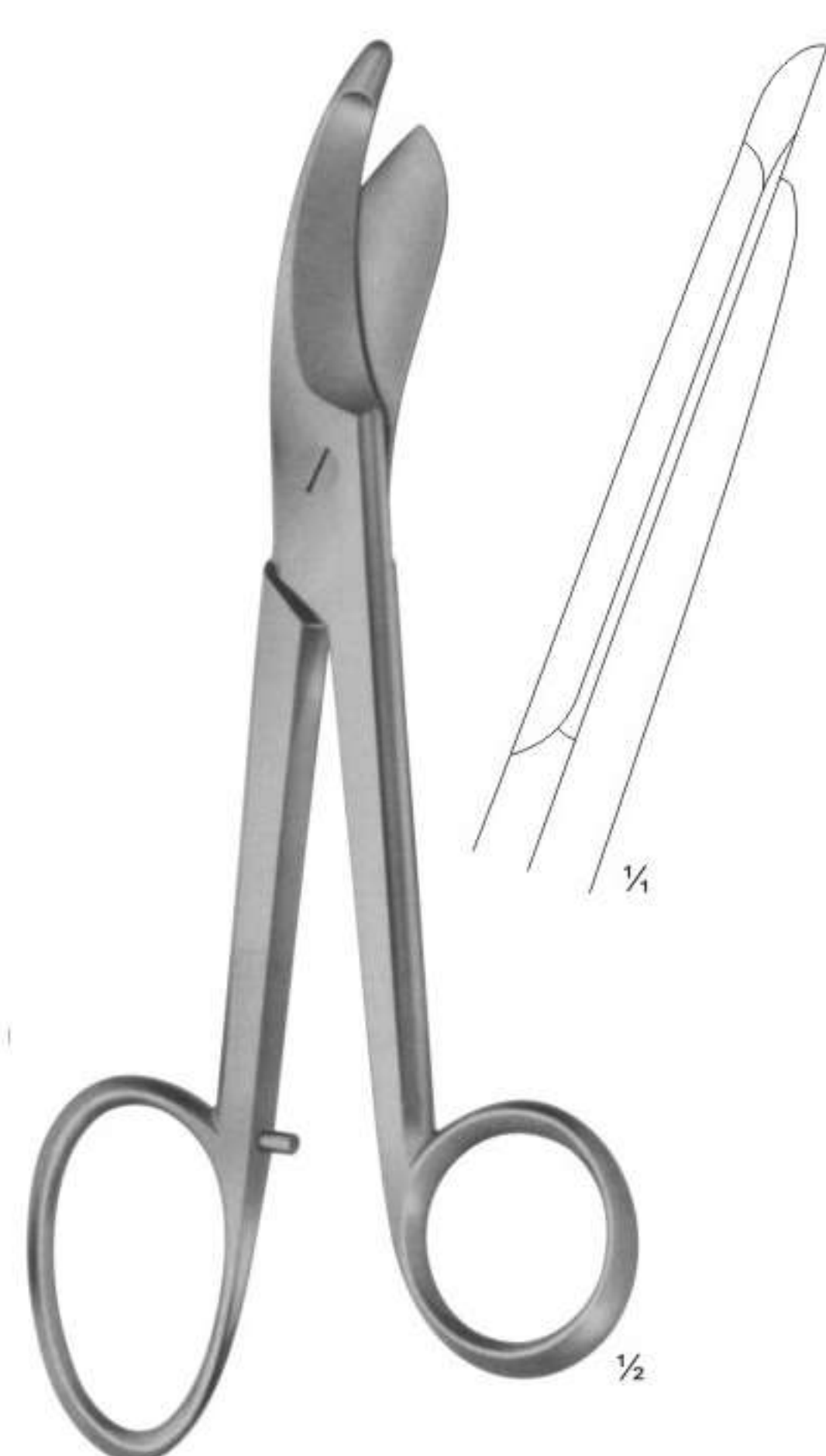

DMI-1-1275
Bandage Scissors 235 mm





DMI-1-1301
YASARGIL-SAMII Jaws spoon-
shaped 240 mm



DMI-1-1302
YASARGIL-SAMII Jaws spoon-
shaped 240 mm



DMI-1-1303
YASARGIL-SAMII Jaws spoon-
shaped 240 mm



DMI-1-1304
YASARGIL Jaws spoon-
shaped 220 mm



DMI-1-1305
YASARGIL Jaws spoon-
shaped 220 mm



DMI-1-1306
SAMII Jaws spoon-
shaped 230 mm



DMI-1-1307
SAMIIJaws spoon-
shaped 230 mm



DMI-1-1308
SAMIIJaws spoon-
shaped 230 mm



DMI-1-1309
SAMIIJaws spoon-
shaped 230 mm



DMI-1-1310
SAMIIJaws spoon-
shaped 230 mm



DMI-1-1311
SAMIIJaws spoon-
shaped 230 mm



DMI-1-1312
HUNT Tumor-andvessel
forceps 200 mm



DMI-1-1313
HUNT Tumor and vessel
forceps 200 mm



DMI-1-1314
YASARGIL Tumor and vessel
forceps 200 mm

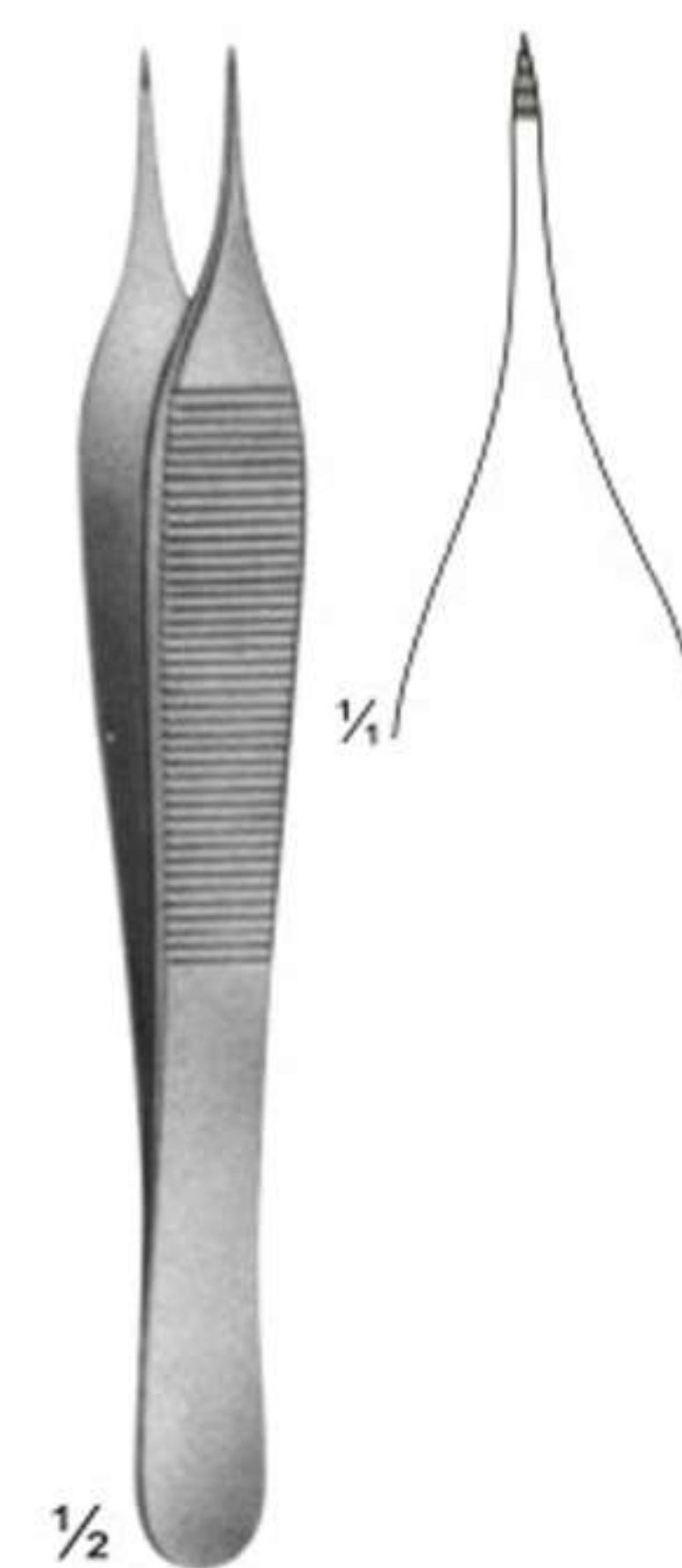

DMI-1-1315
THORPE Corneal forceps
120 mm

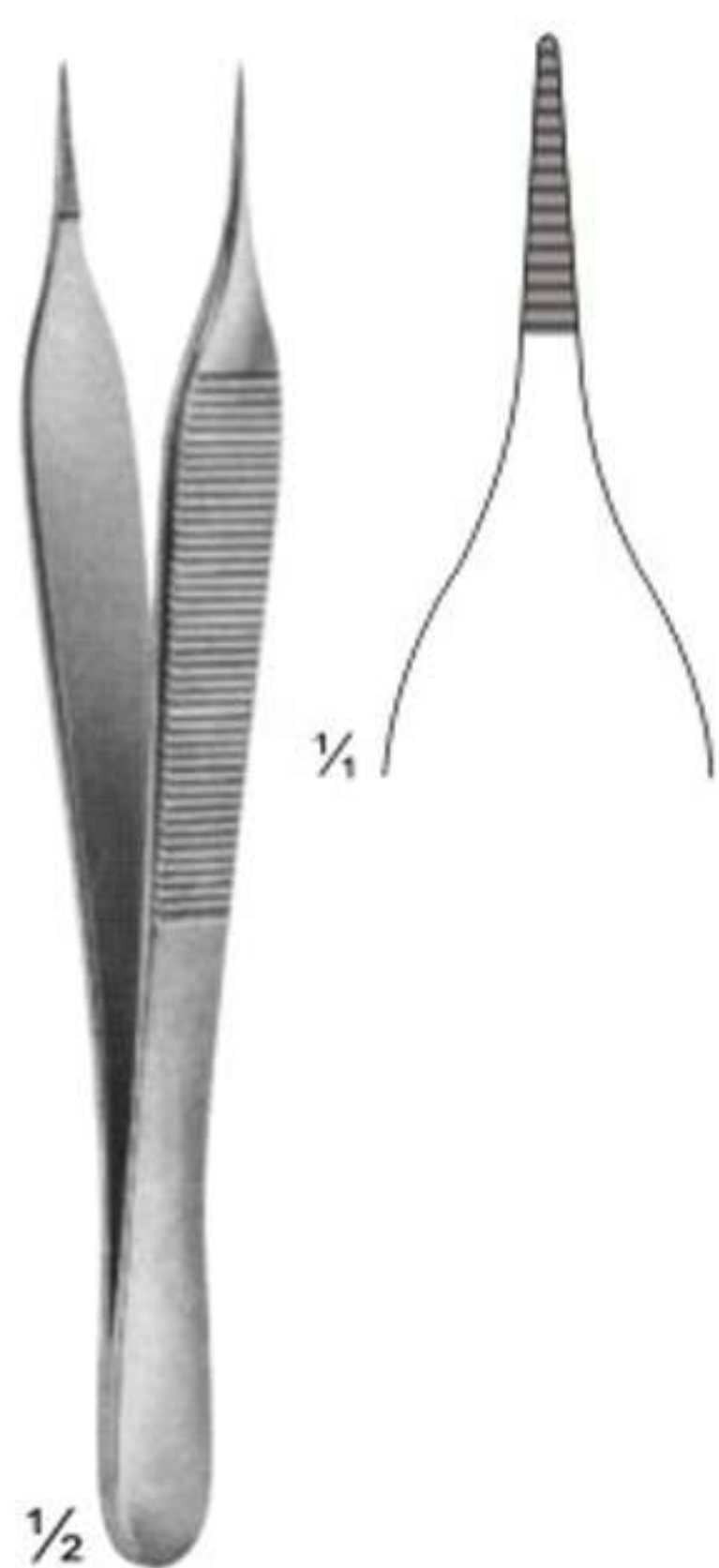

DMI-1-1316
MICRO-ADSON 120 mm

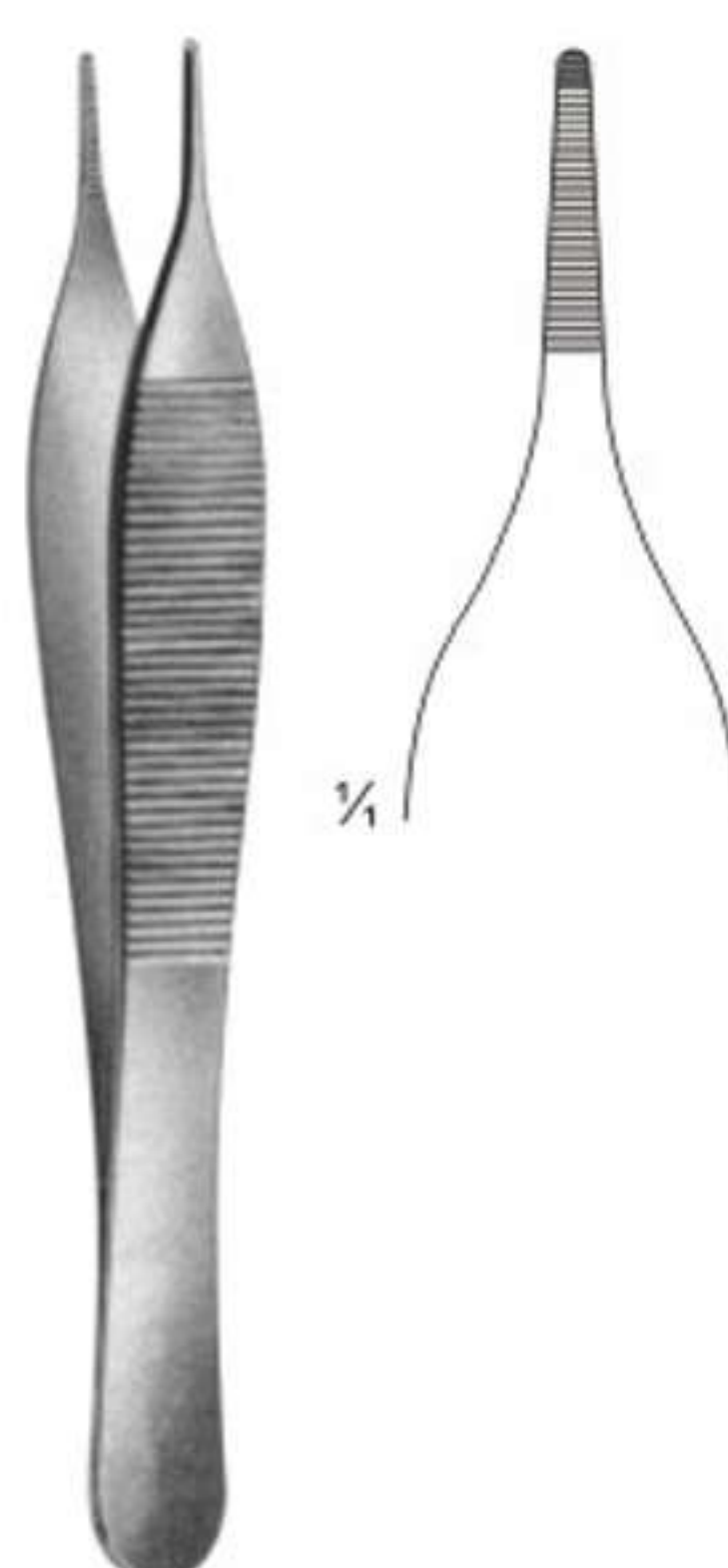

DMI-1-1317
ADSON 120 mm

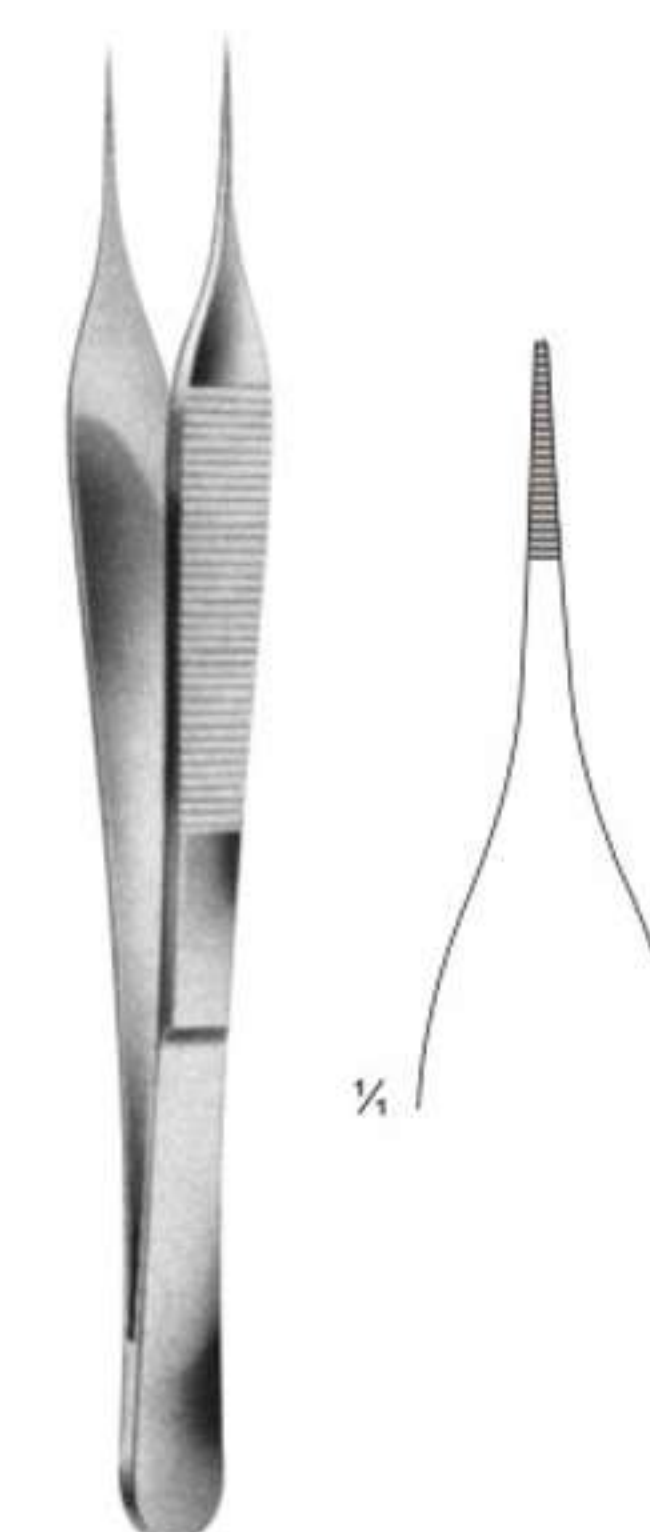

DMI-1-1318
MICRO-ADSON 150 mm

Dissecting and Tissue Forceps



DMI-1-1319
100 mm



DMI-1-1320
100 mm

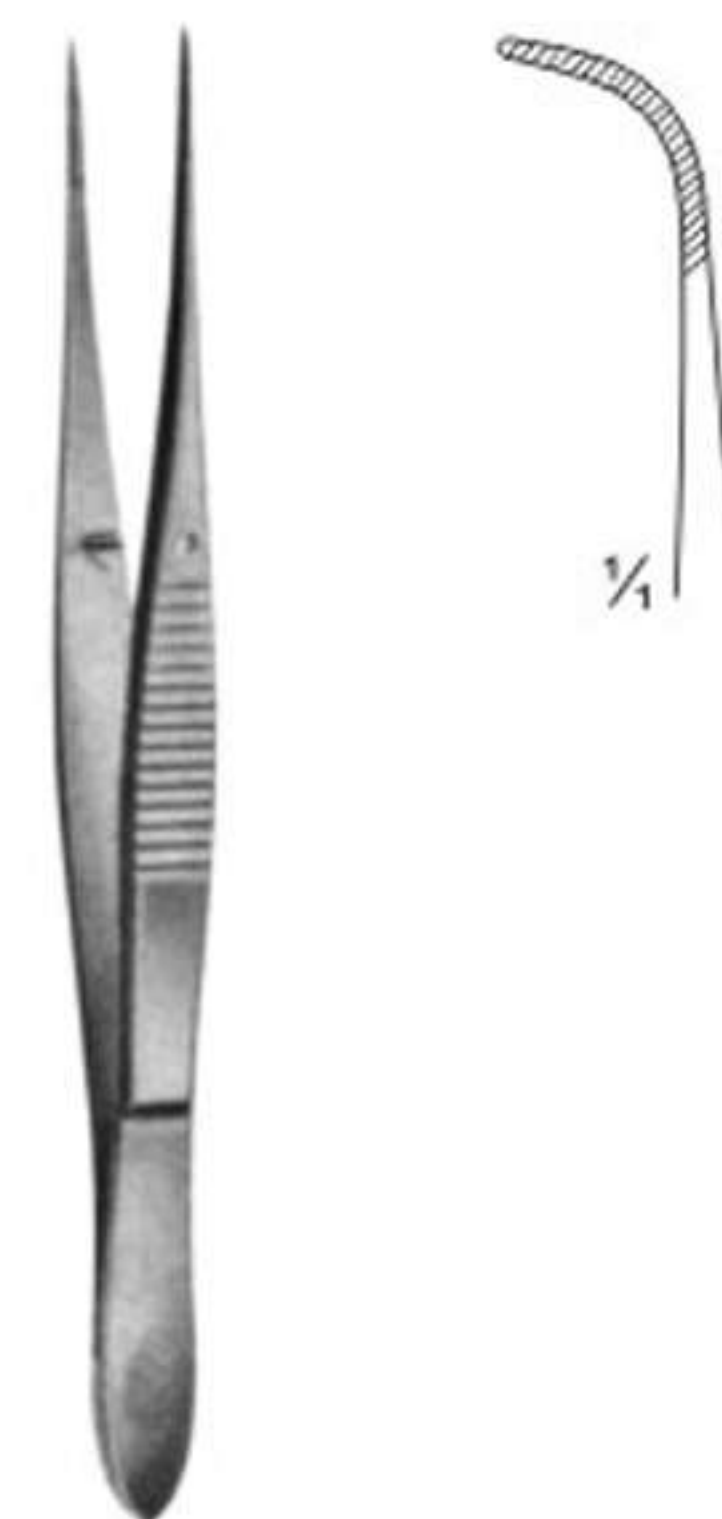

DMI-1-1321
100 mm

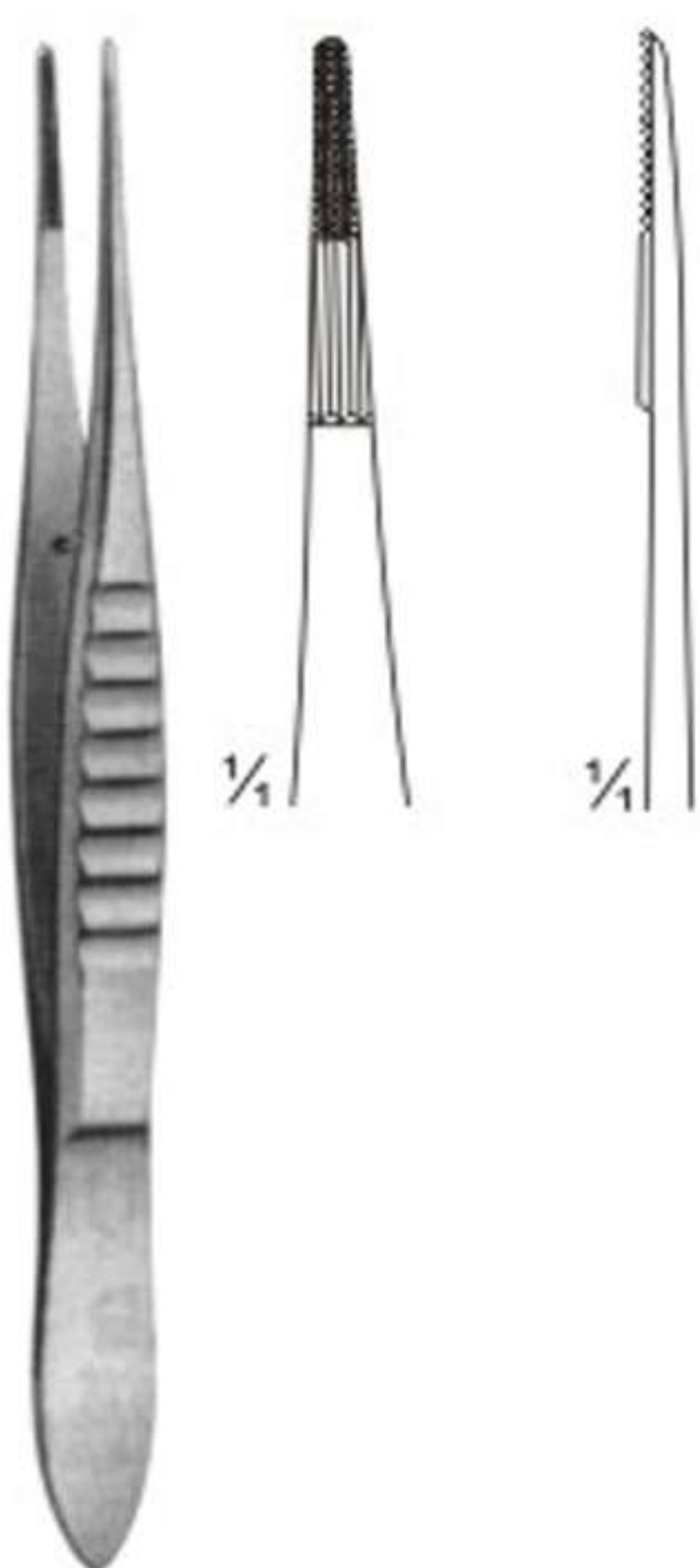

DMI-1-1322
BONACCOLTO 110 mm

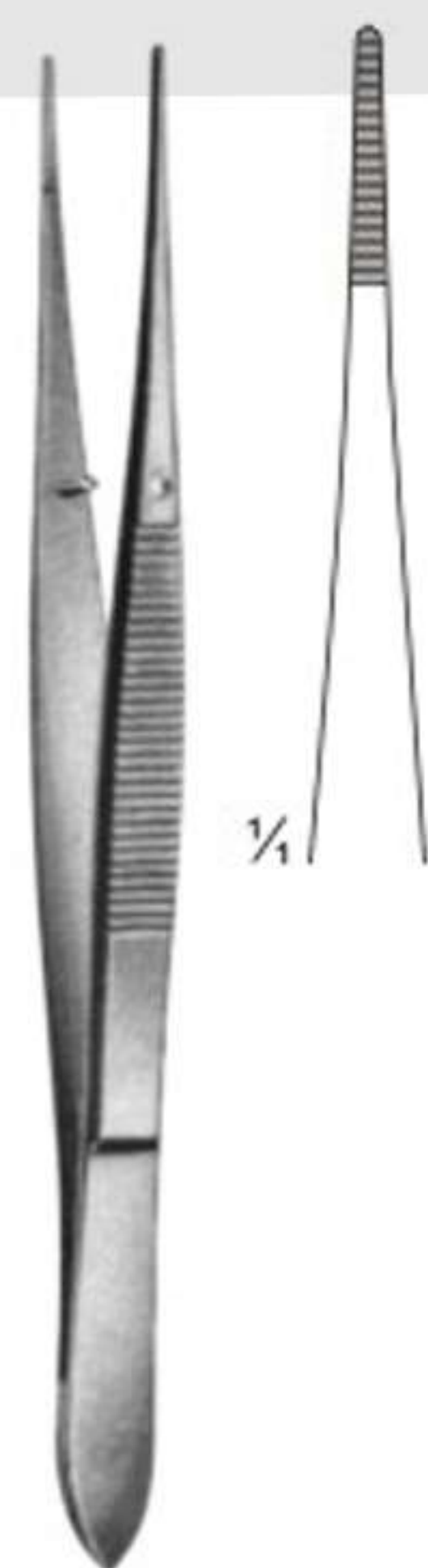

DMI-1-1323
115 mm



DMI-1-1324
90 mm

Dissecting and Tissue Forceps

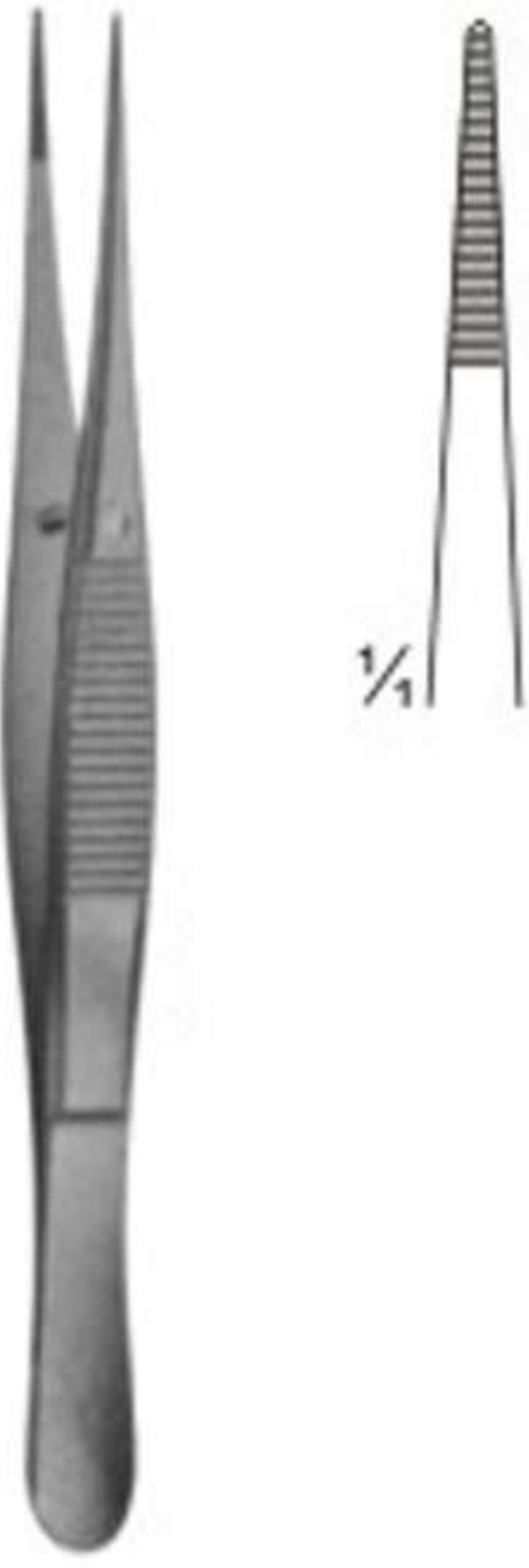

DMI-1-1325
105 mm

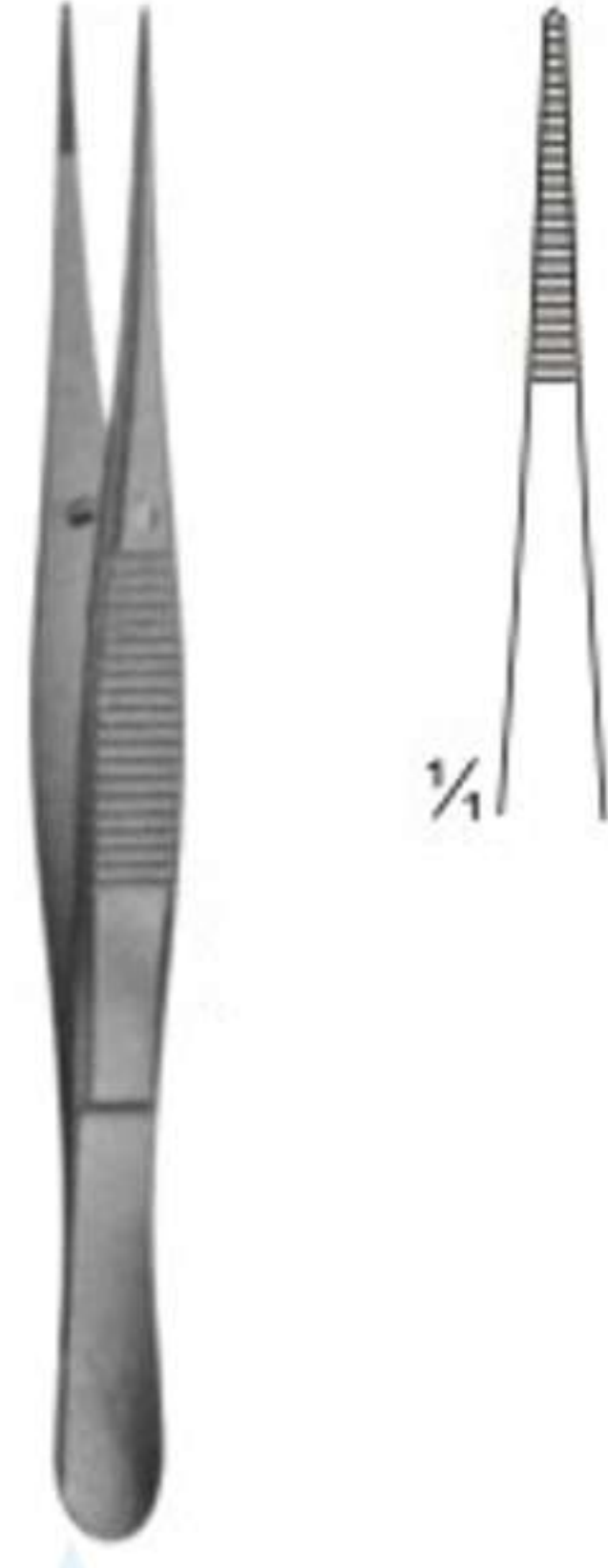

DMI-1-1326
115 mm

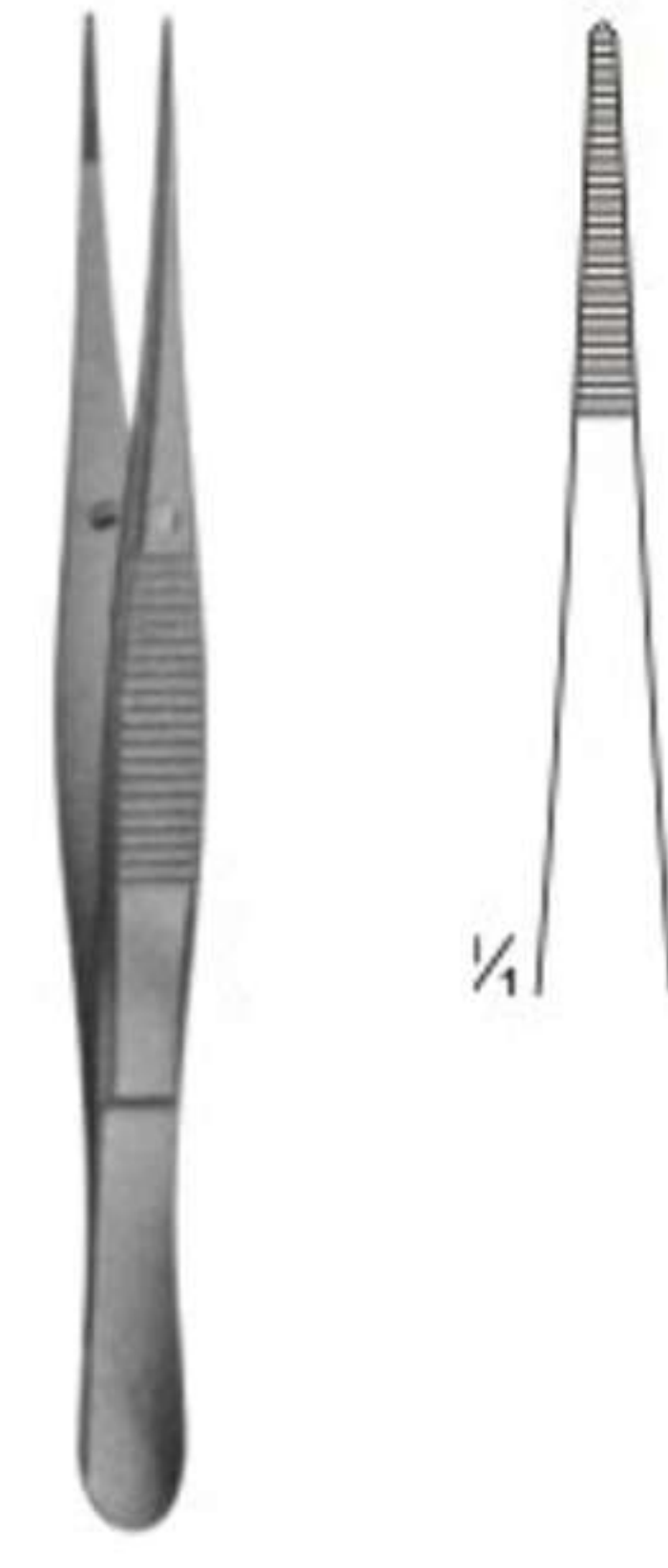

DMI-1-1327
130 mm

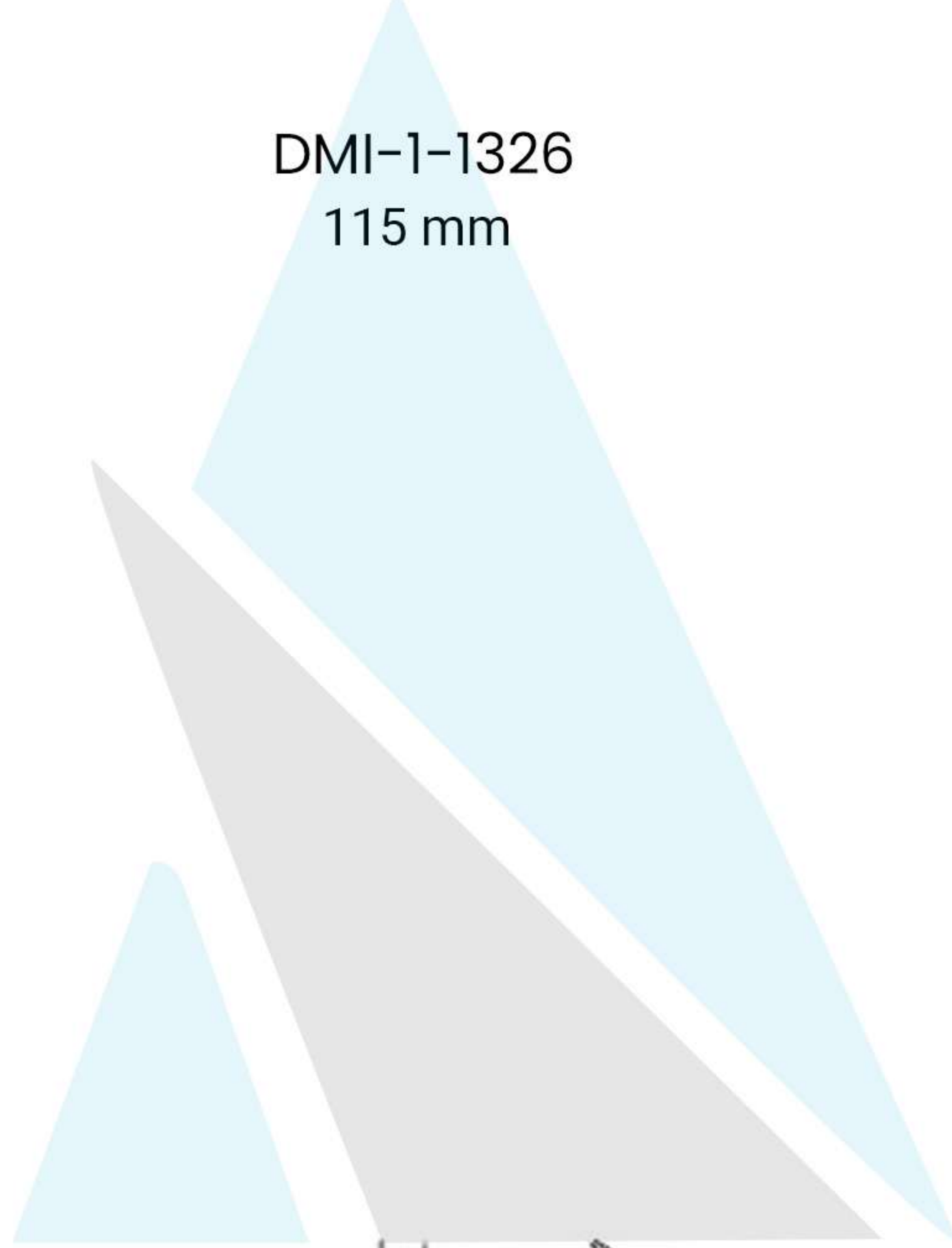

DMI-1-1328
145 mm



DMI-1-1329
90 mm

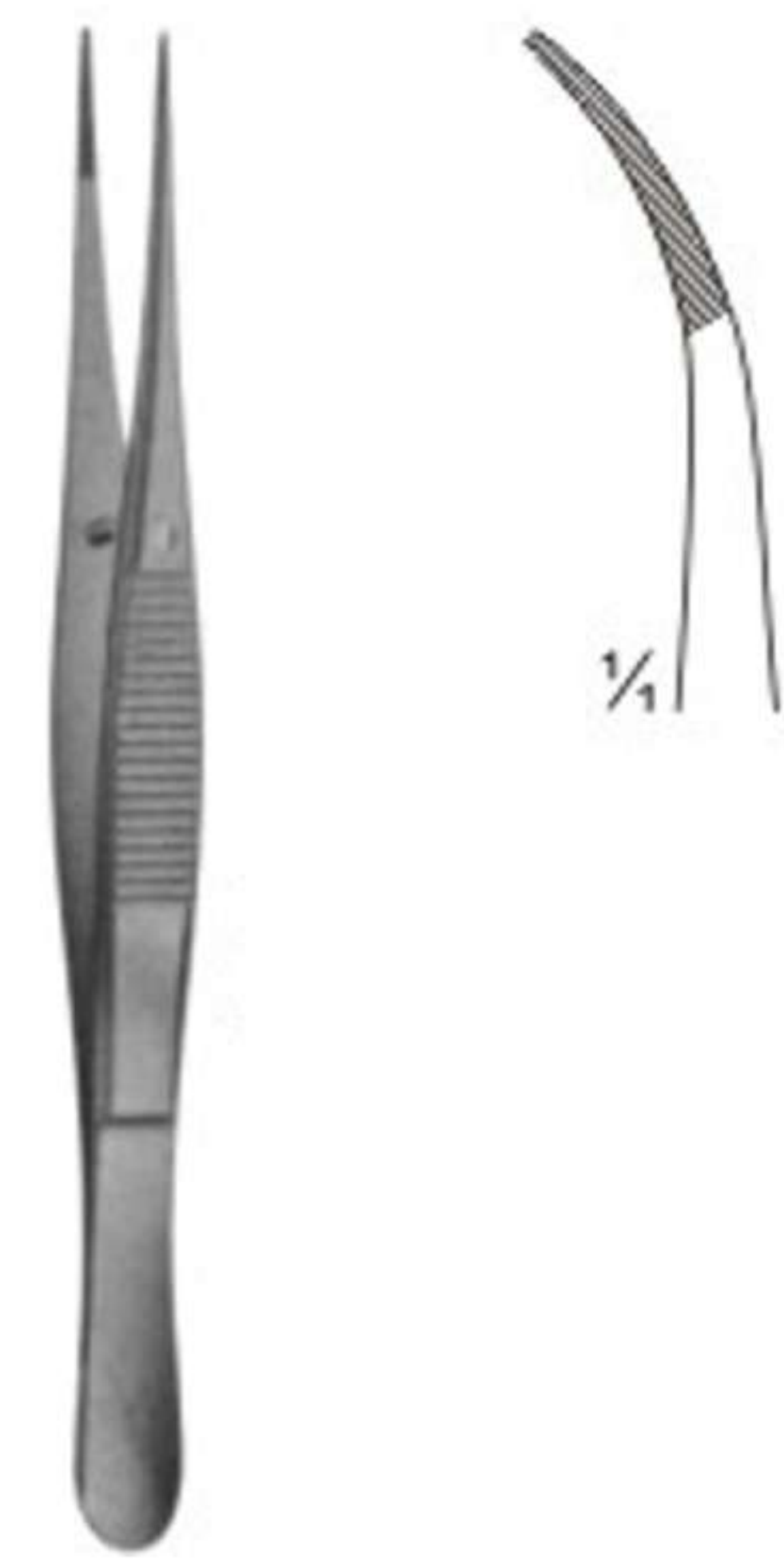

DMI-1-1330
105 mm

Dissecting and Tissue Forceps

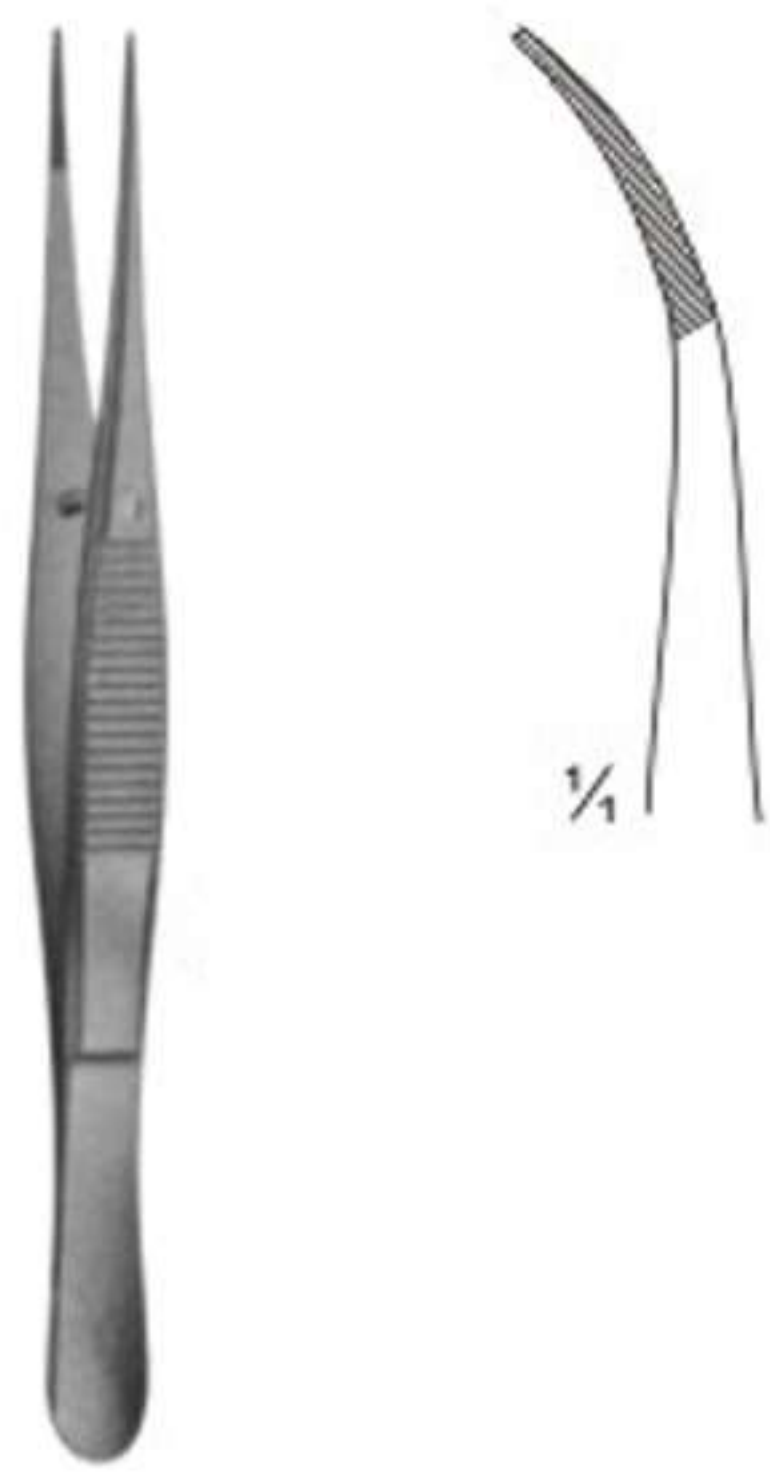

DMI-1-1331
115 mm

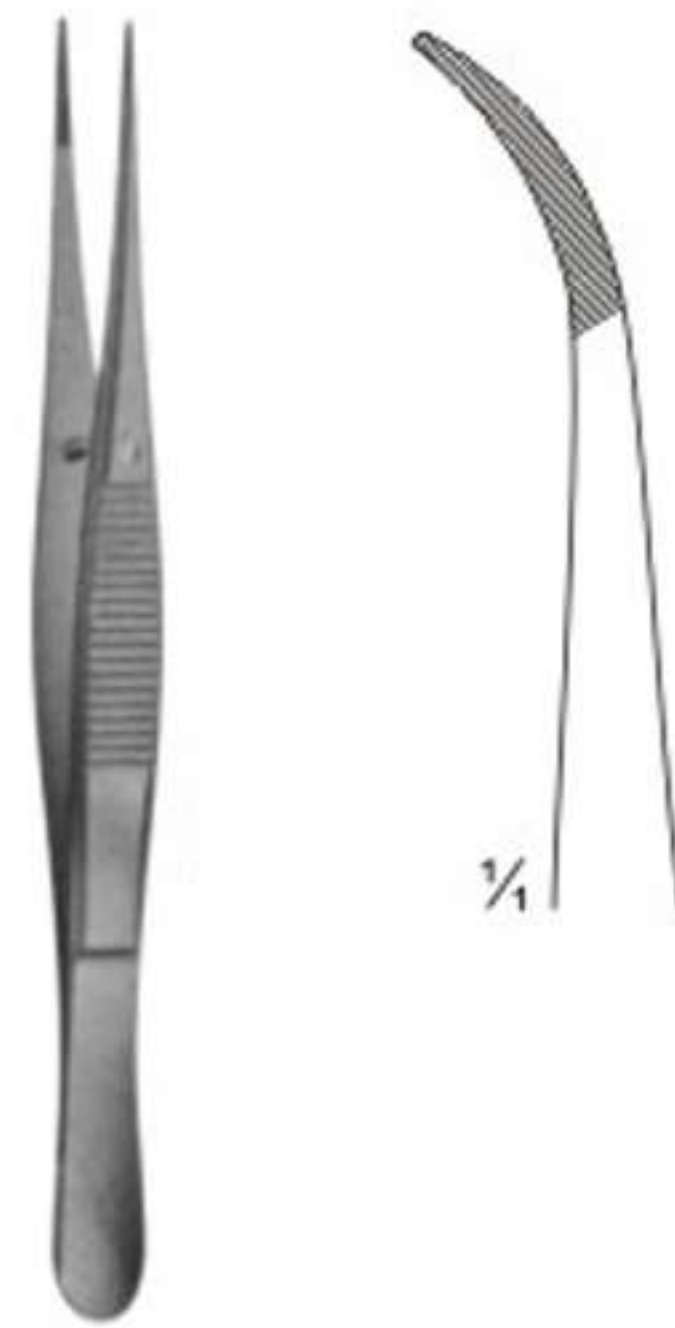

DMI-1-1332
130 mm

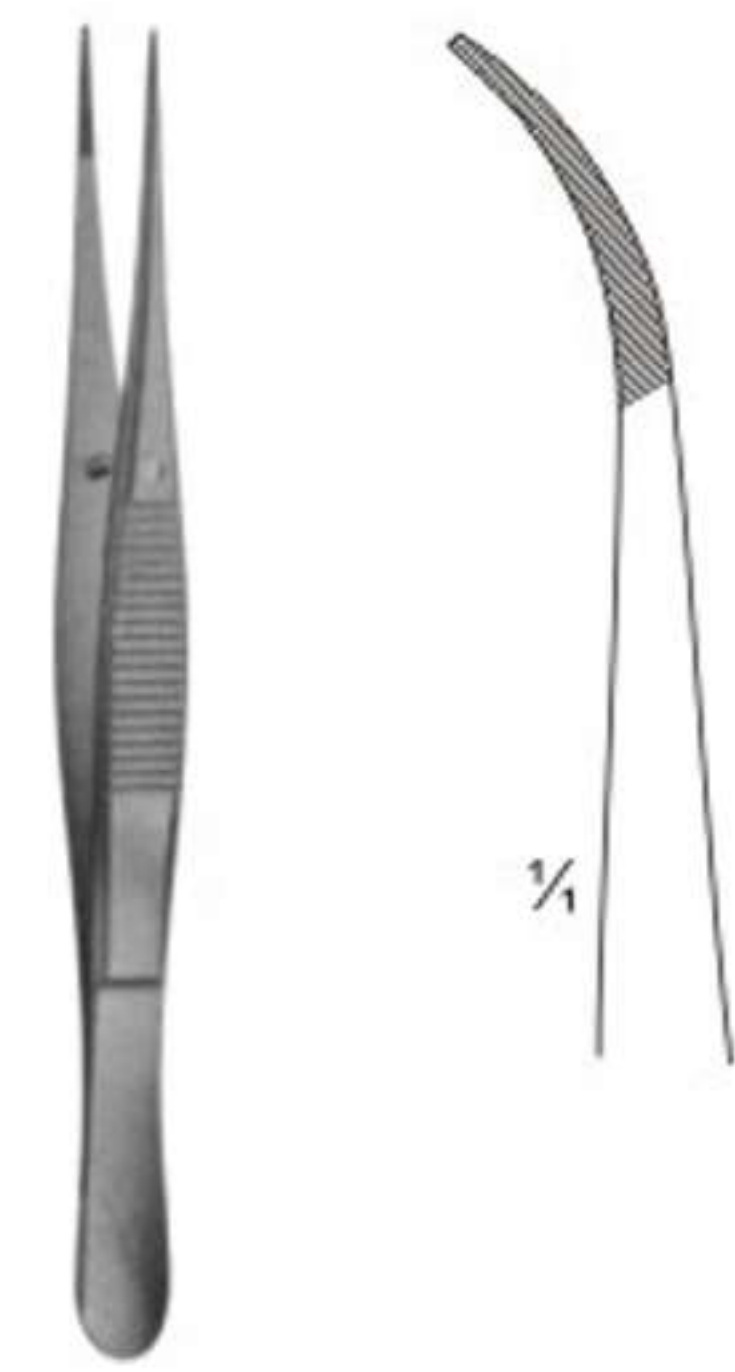

DMI-1-1333
145 mm

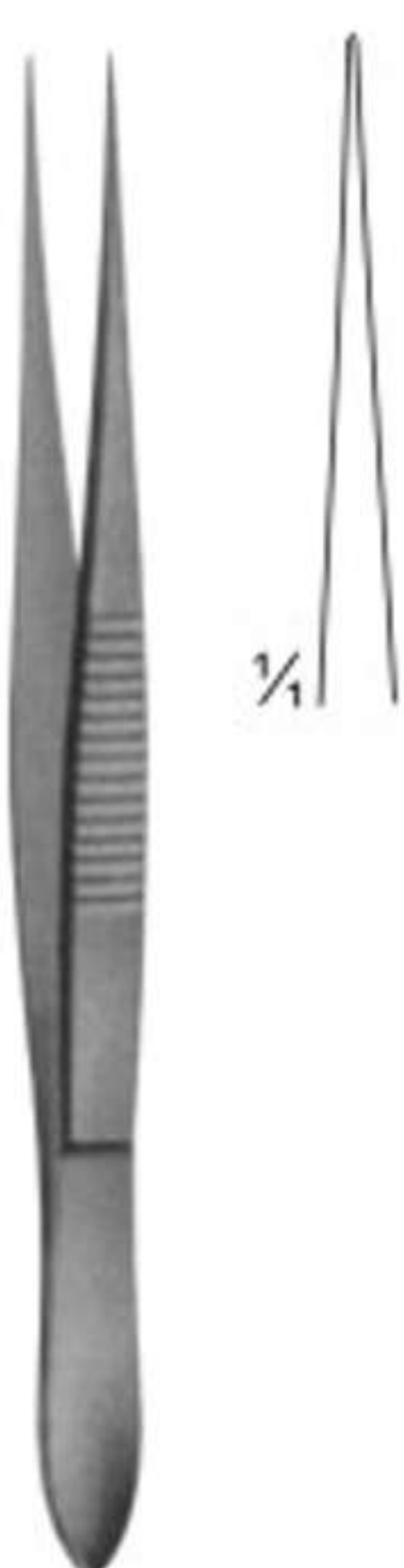
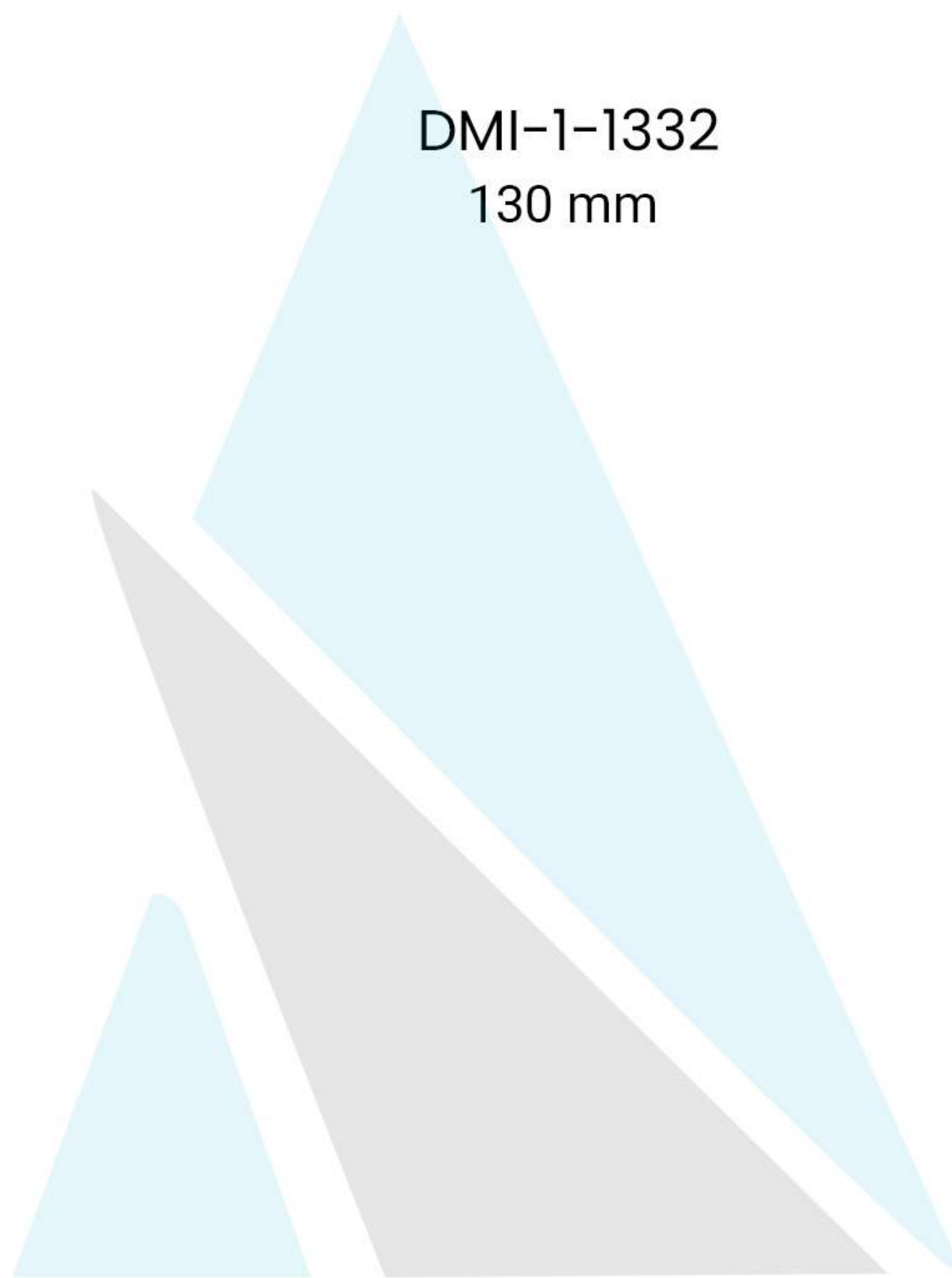

DMI-1-1334
100 mm

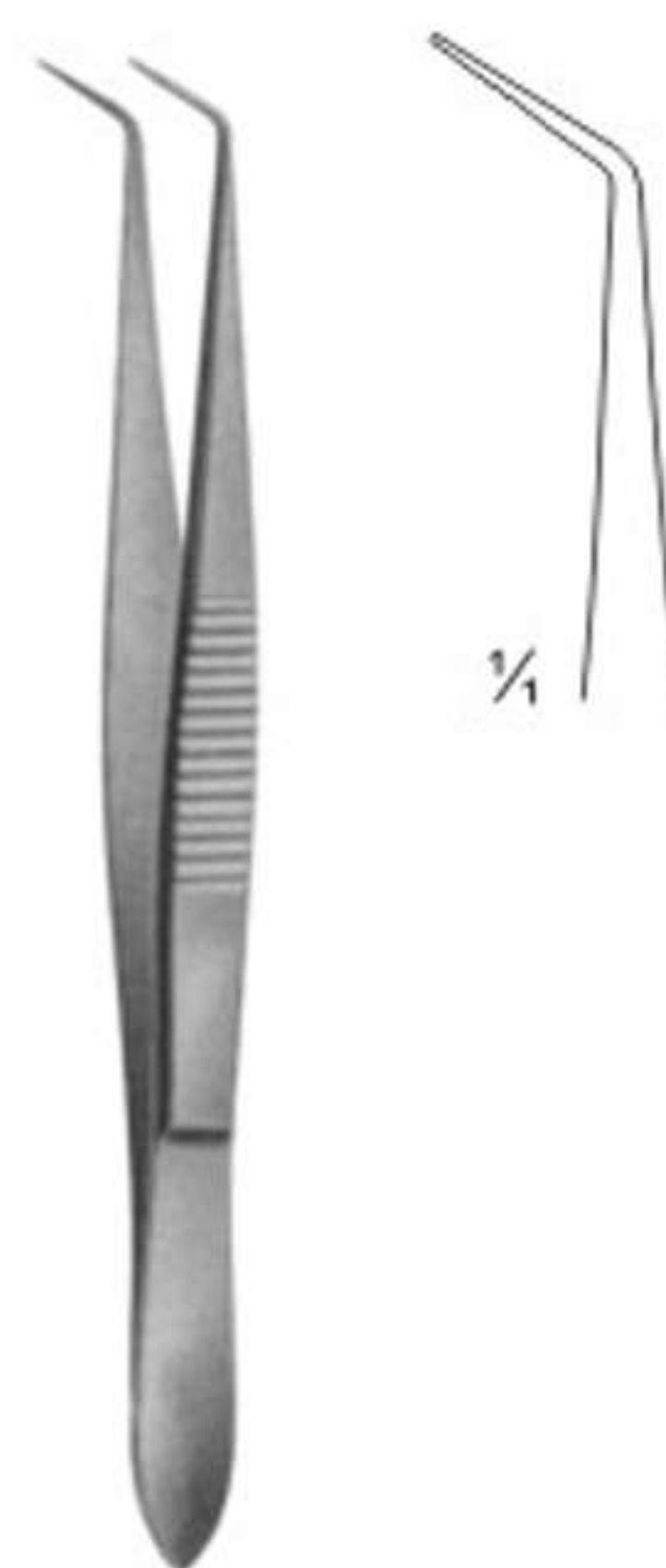

DMI-1-1335
100 mm



ART-DSC-1-1336
100 mm

Dissecting and Tissue Forceps

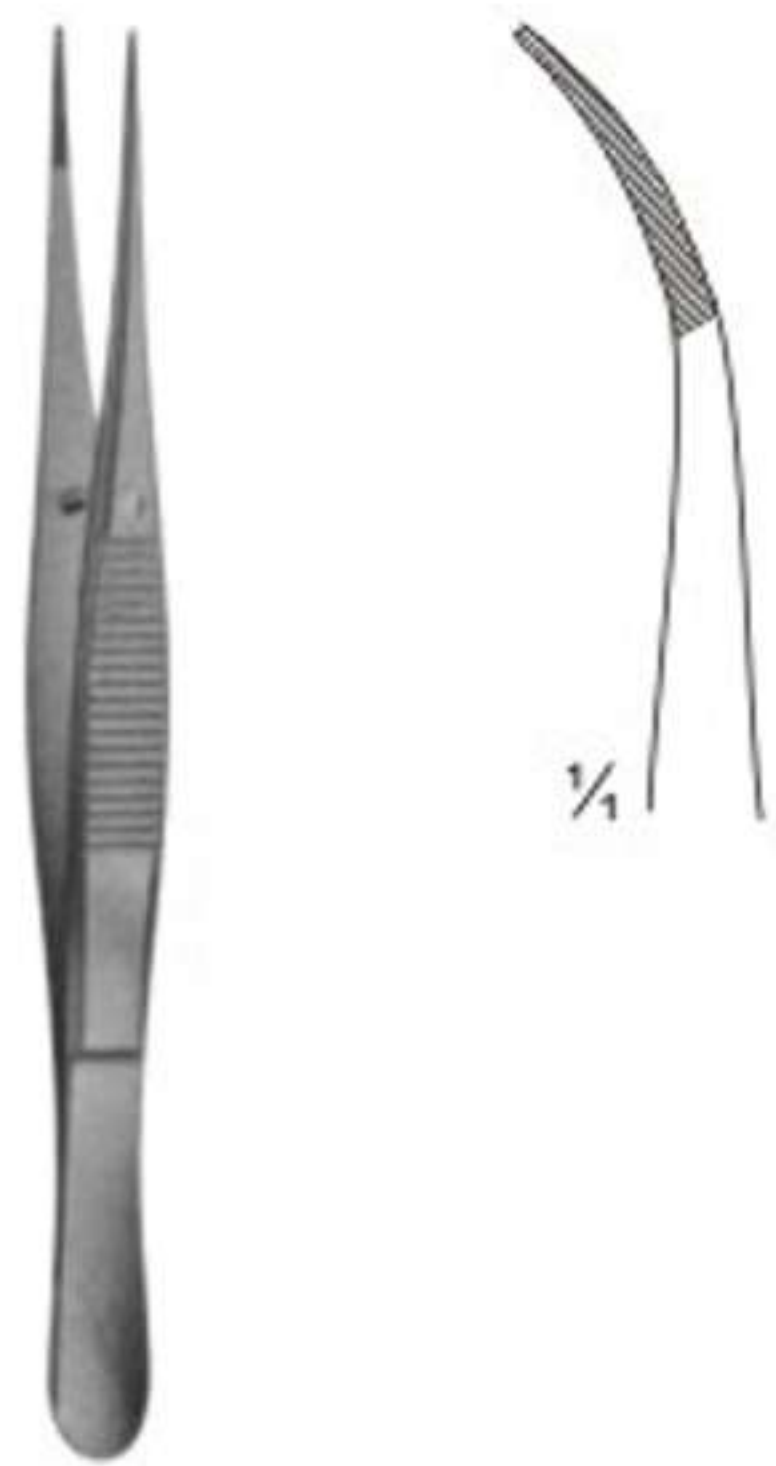

DMI-1-1337
KUHNE Cover glass
forceps, 105 mm



DMI-1-1338
160 mm



DMI-1-1339
125 mm

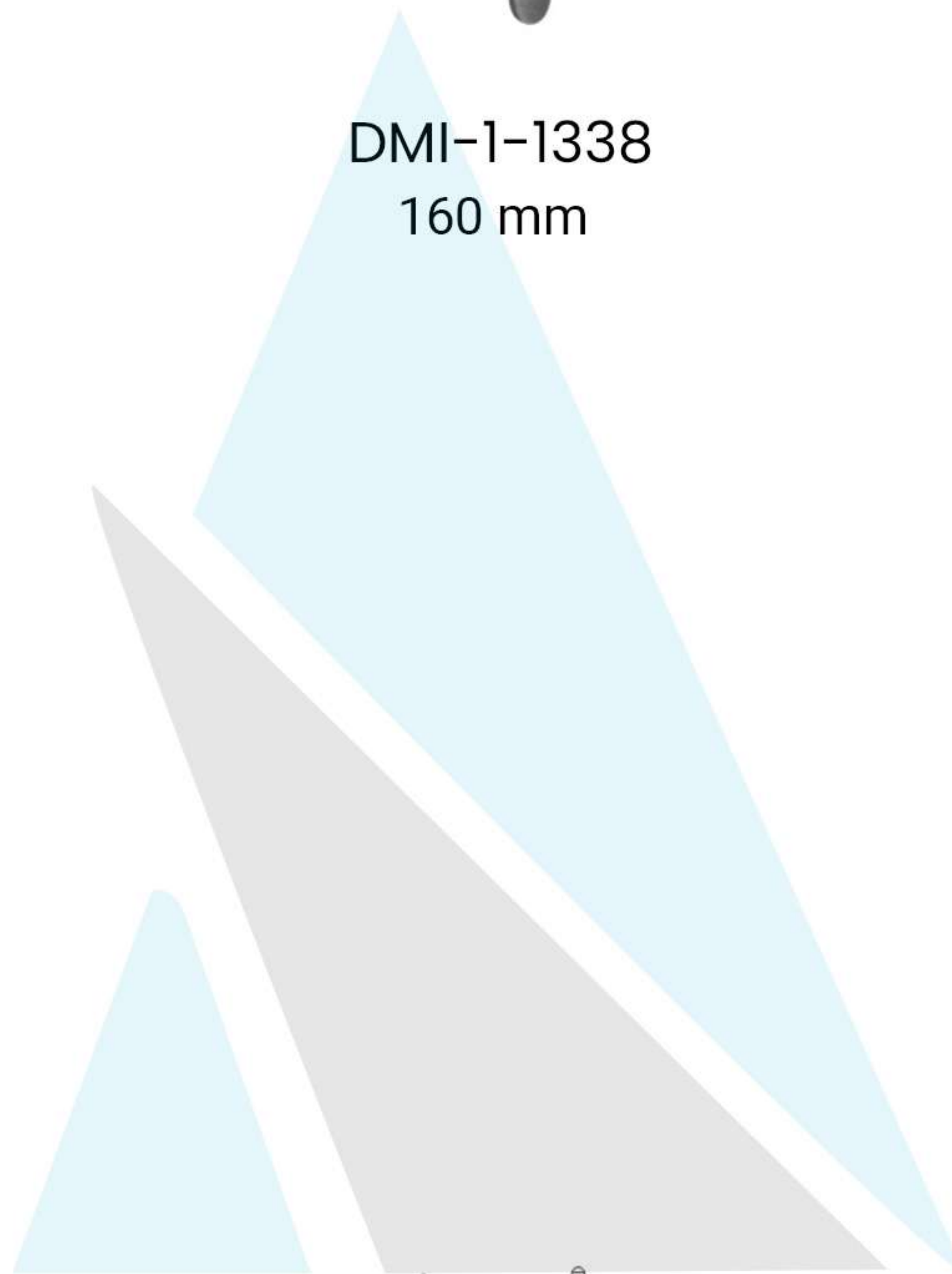

DMI-1-1340
SEMKEN 150 mm

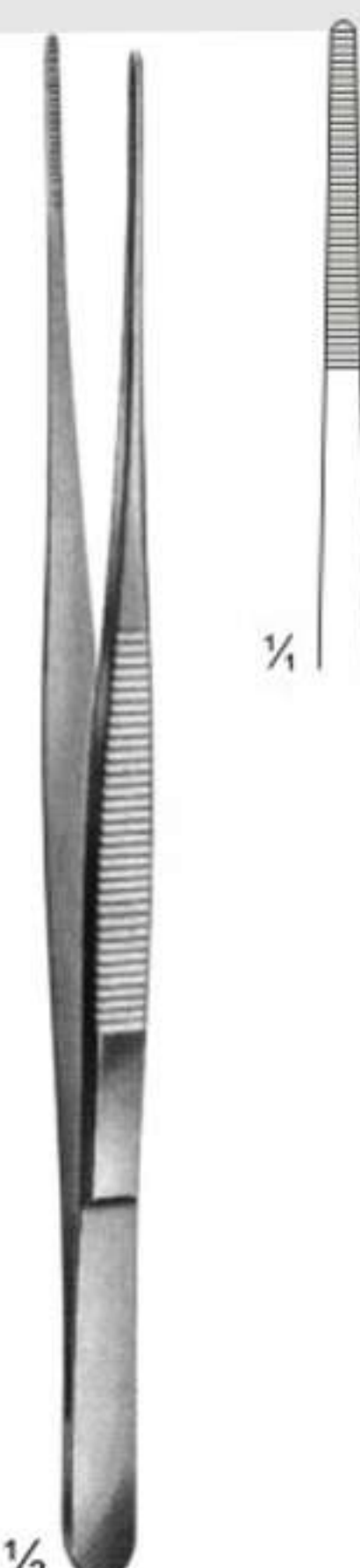

DMI-1-1341
155 mm



DMI-1-1342
MC INDOE 150 mm

Dissecting and Tissue Forceps

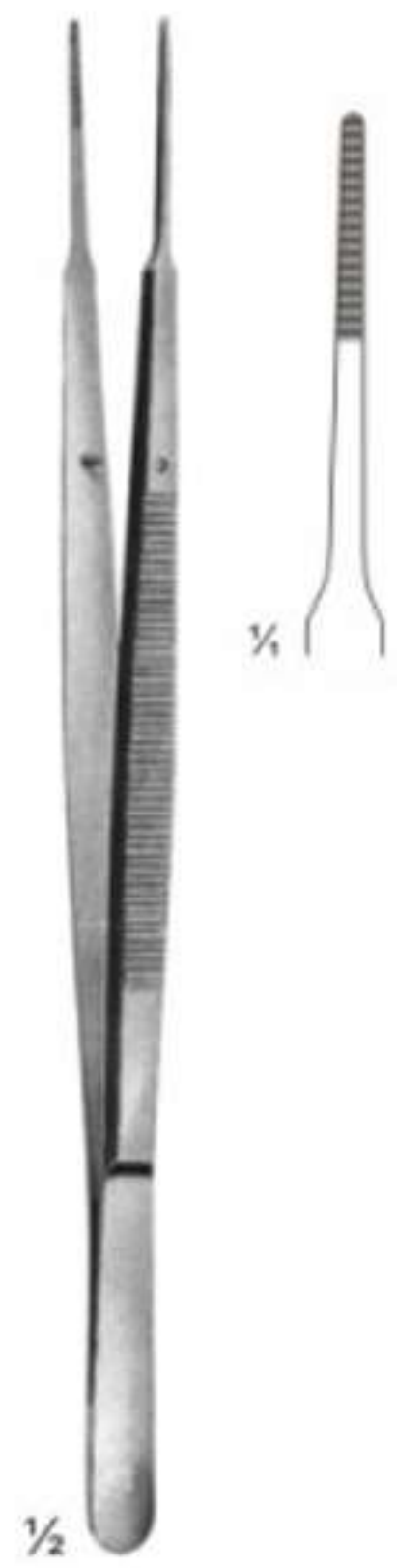

ART-DSC-1-1343
GERALD 175 mm



ART-DSC-1-1344
GERALD 175 mm



ART-DSC-1-1345
GERALD 230 mm

Sponge, Dressing and Tissue Grasping Forceps

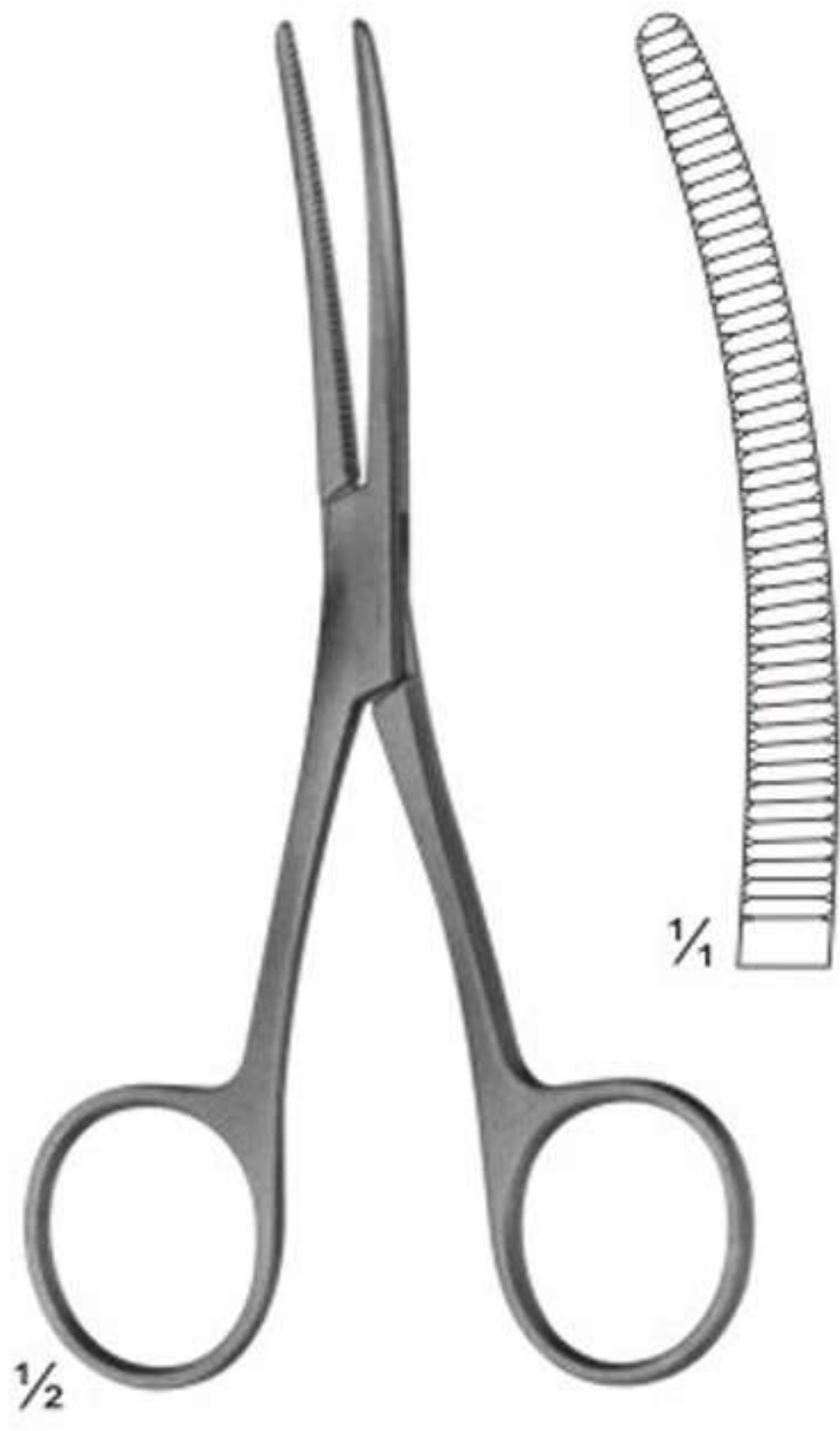

DMI-1-1401
BRYANT 130 mm

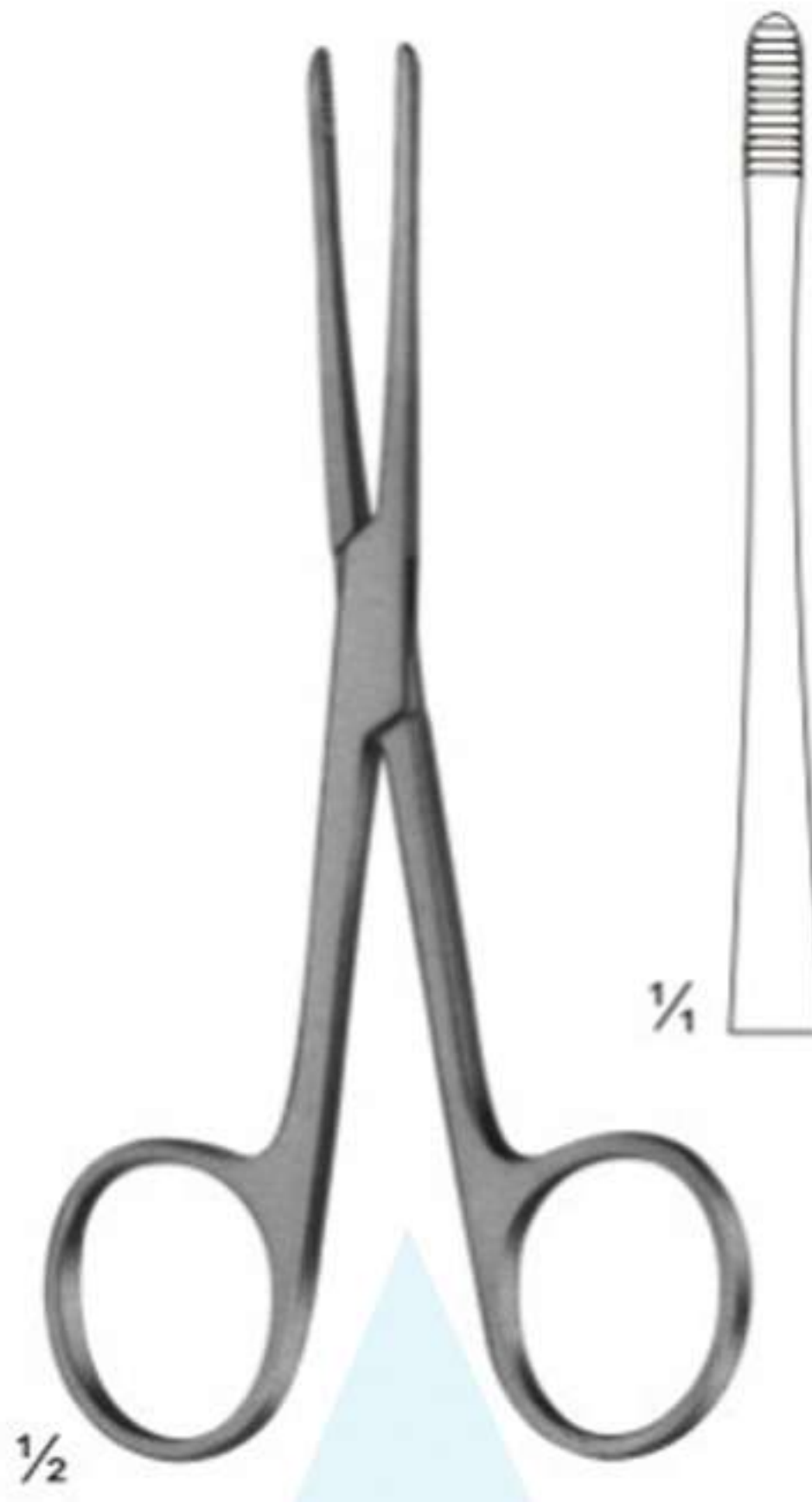

DMI-1-1402
LISTER Sinus forceps 130 mm

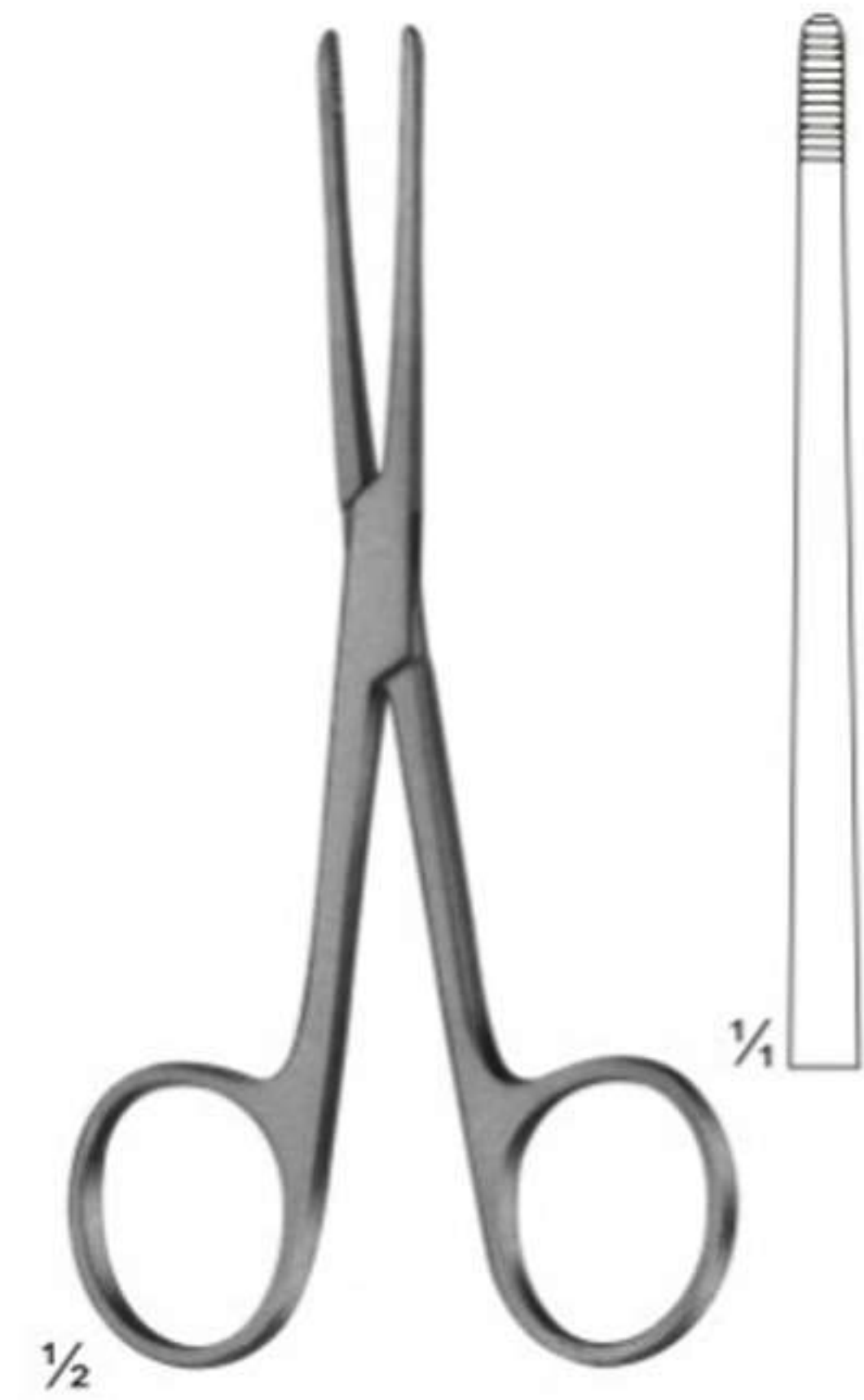

DMI-1-1403
LISTER Sinus forceps 155 mm

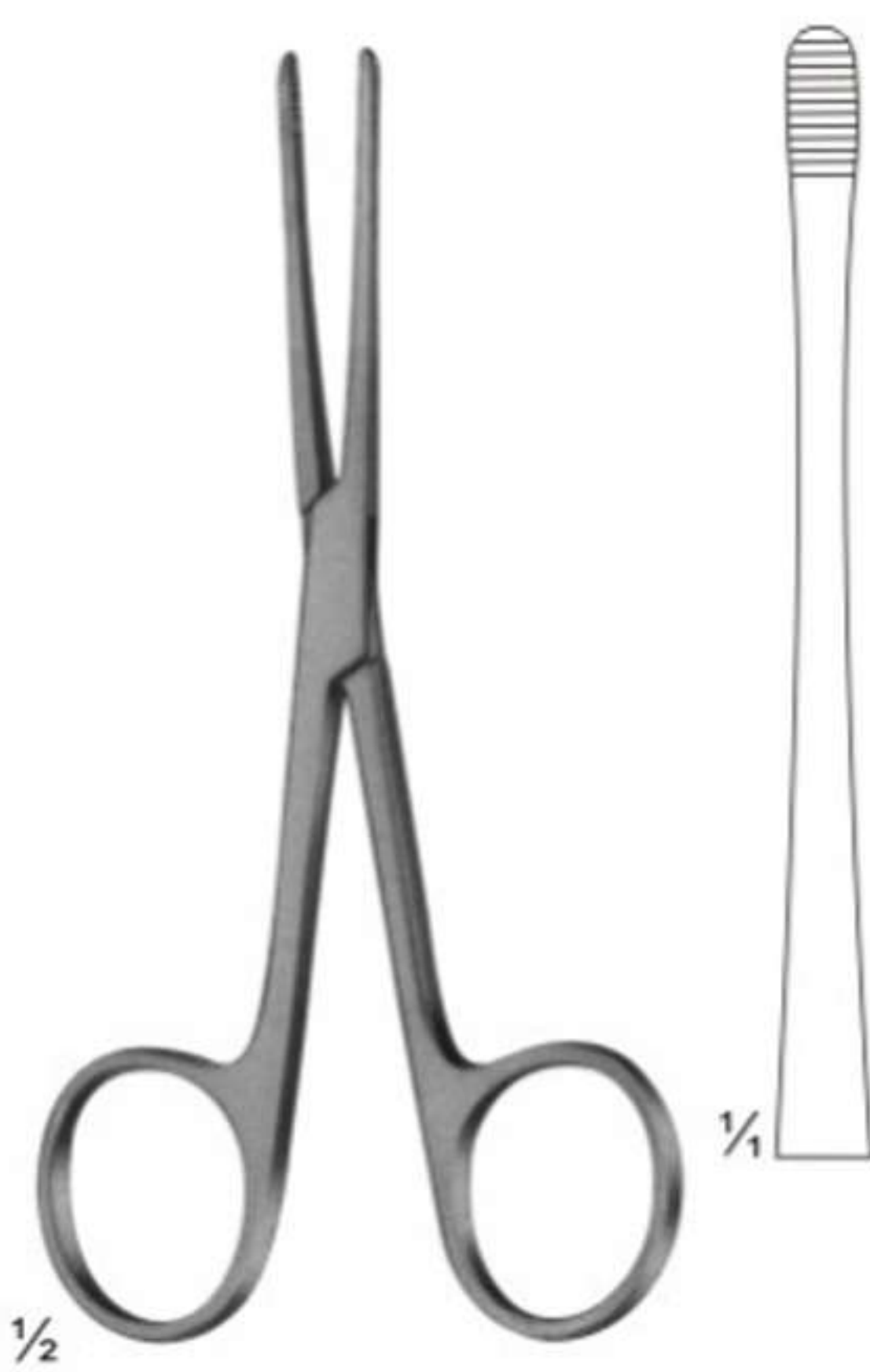

DMI-1-1404
LISTER Sinus forceps 175 mm

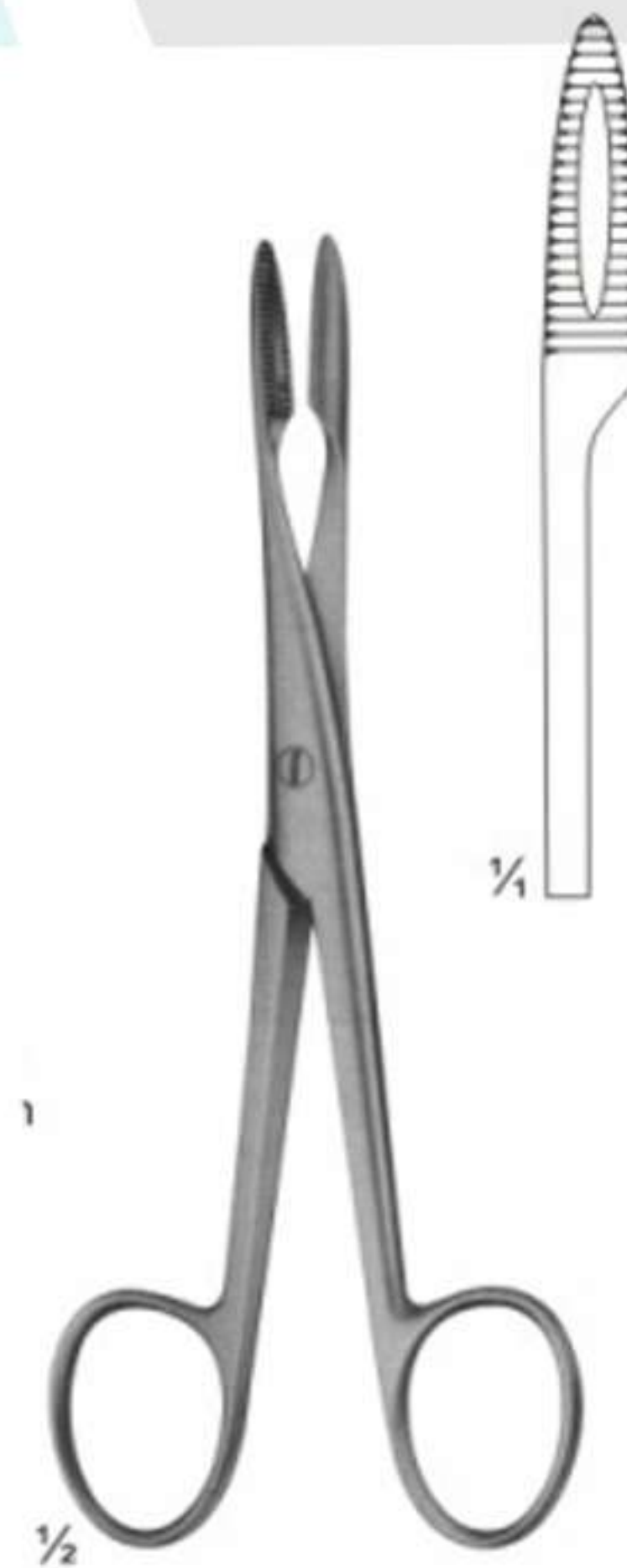

DMI-1-1405
without ratchet 145 mm

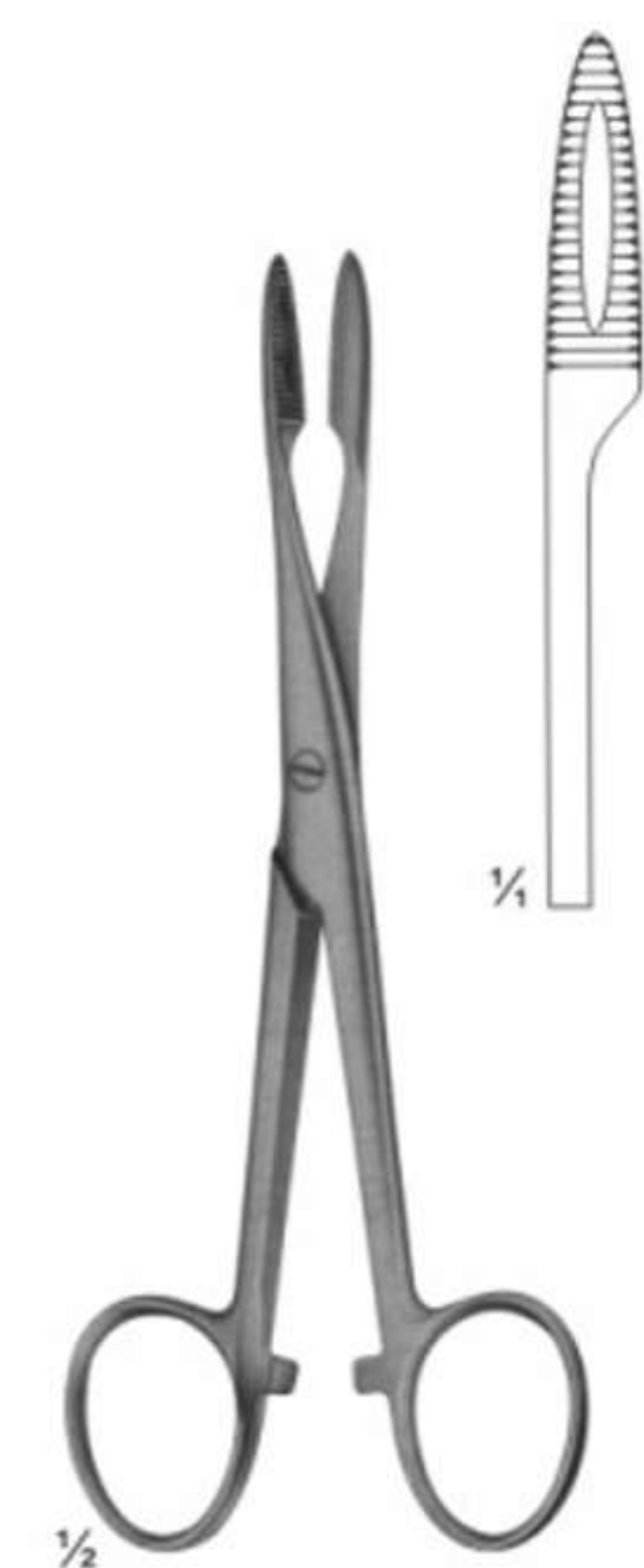

DMI-1-1406
with ratchet 145 mm

Sponge, Dressing and Tissue Grasping Forceps

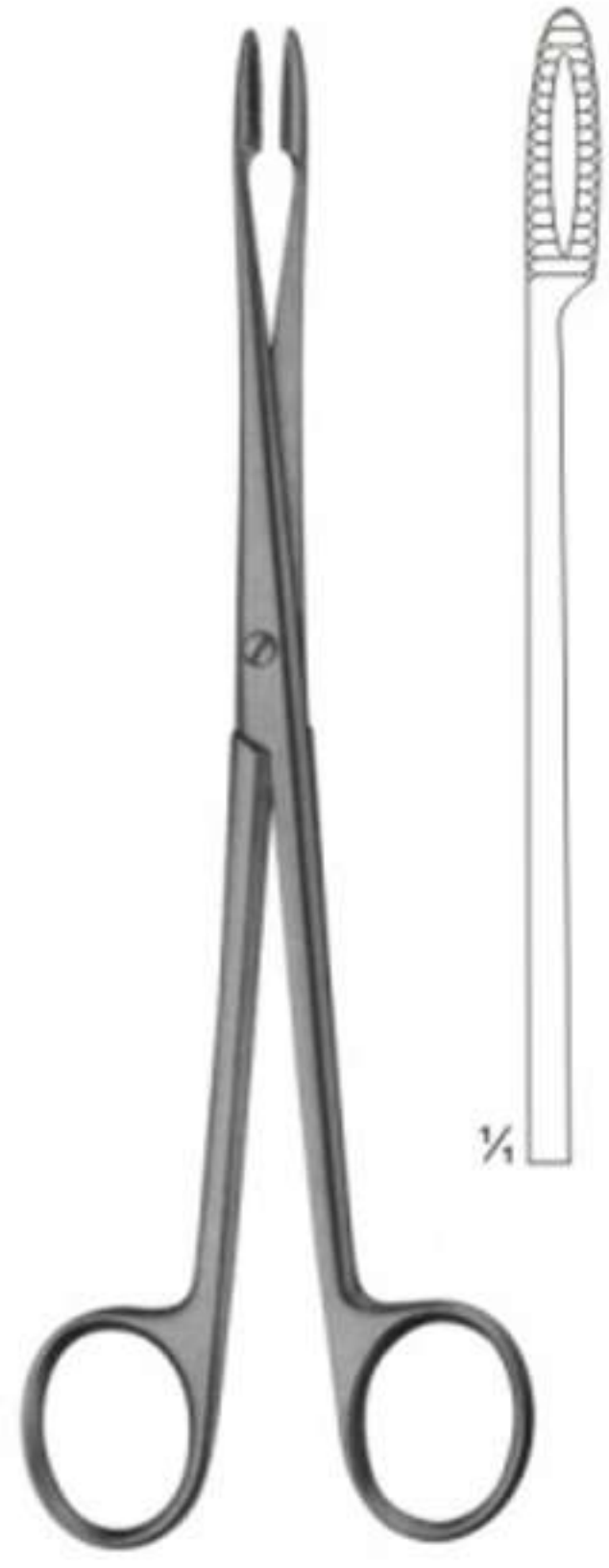

DMI-1-1407
GROSS without ratchet 180 mm

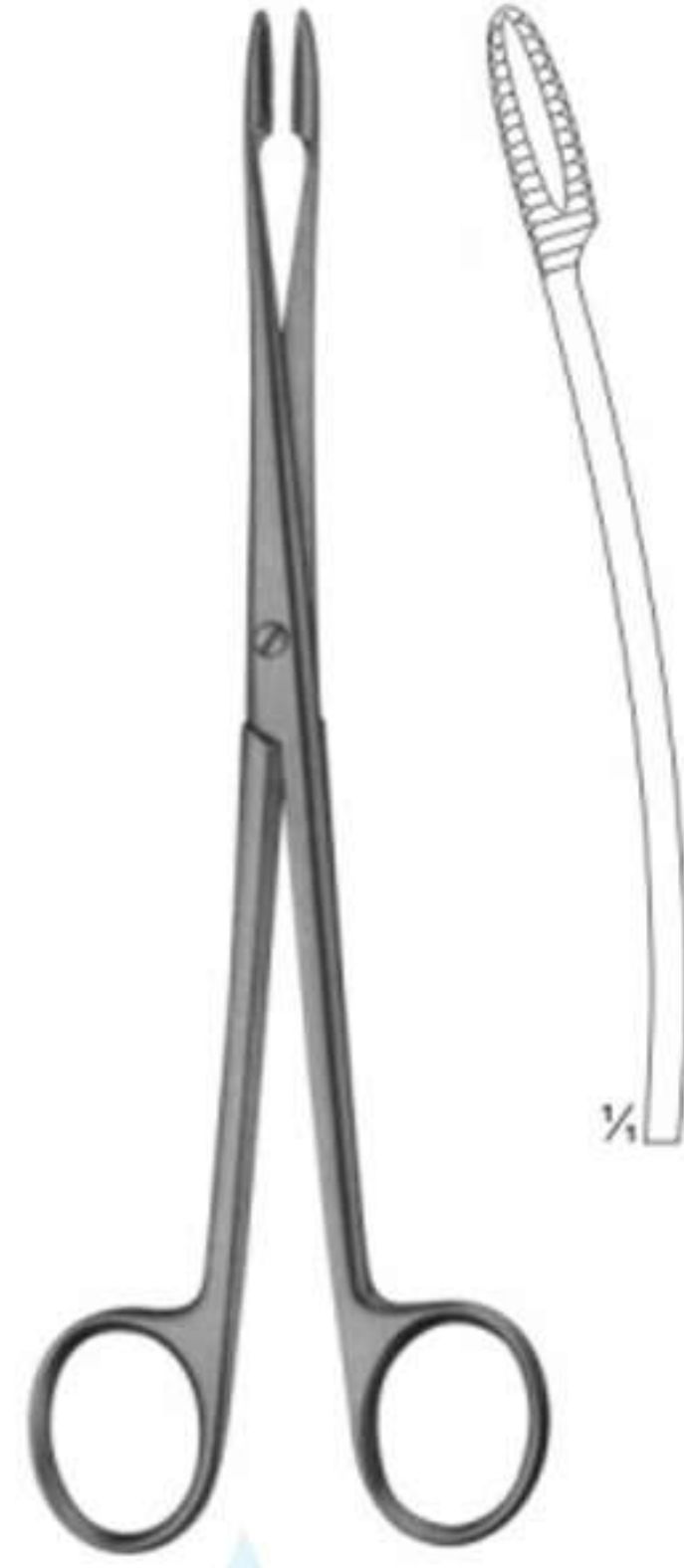

DMI-1-1408
GROSS without ratchet 180 mm

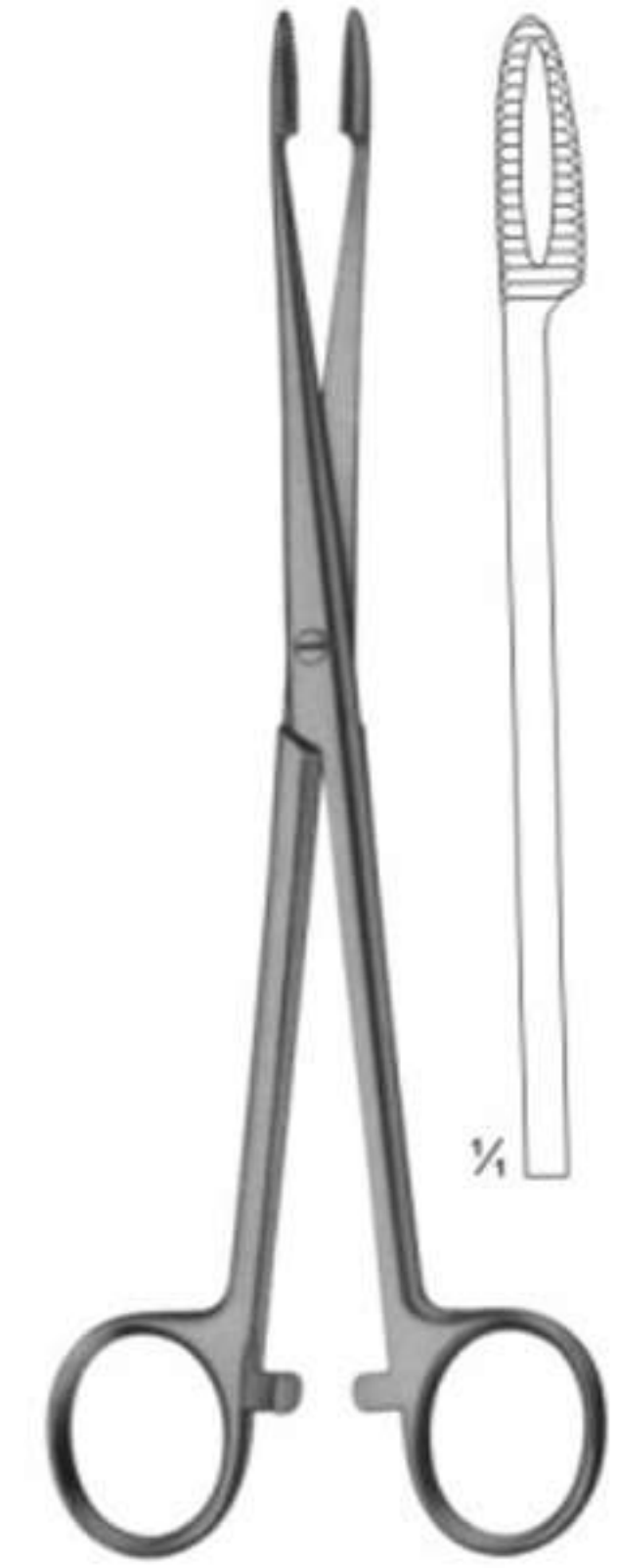

DMI-1-1409
GROSS with ratchet 180 mm

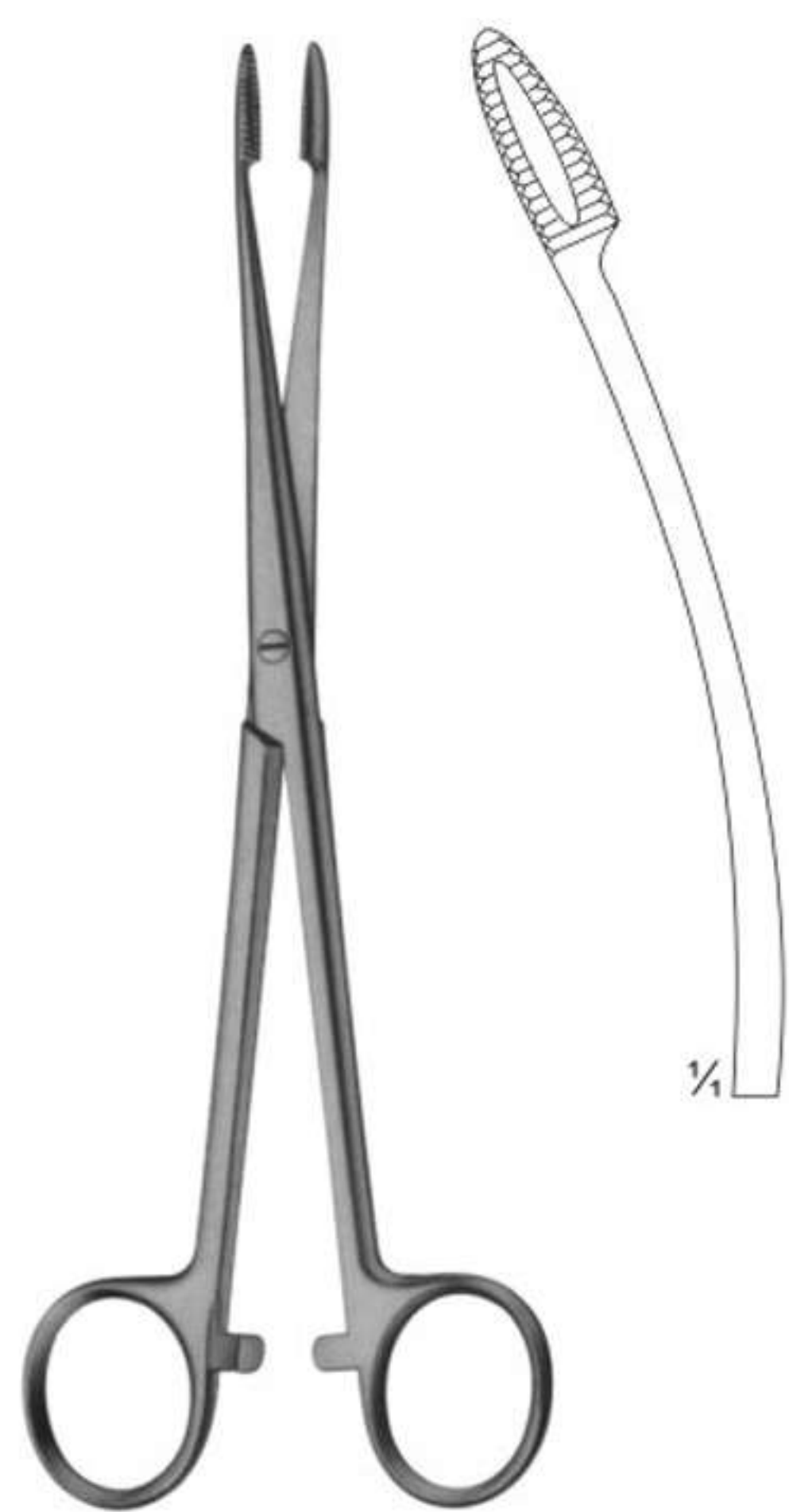
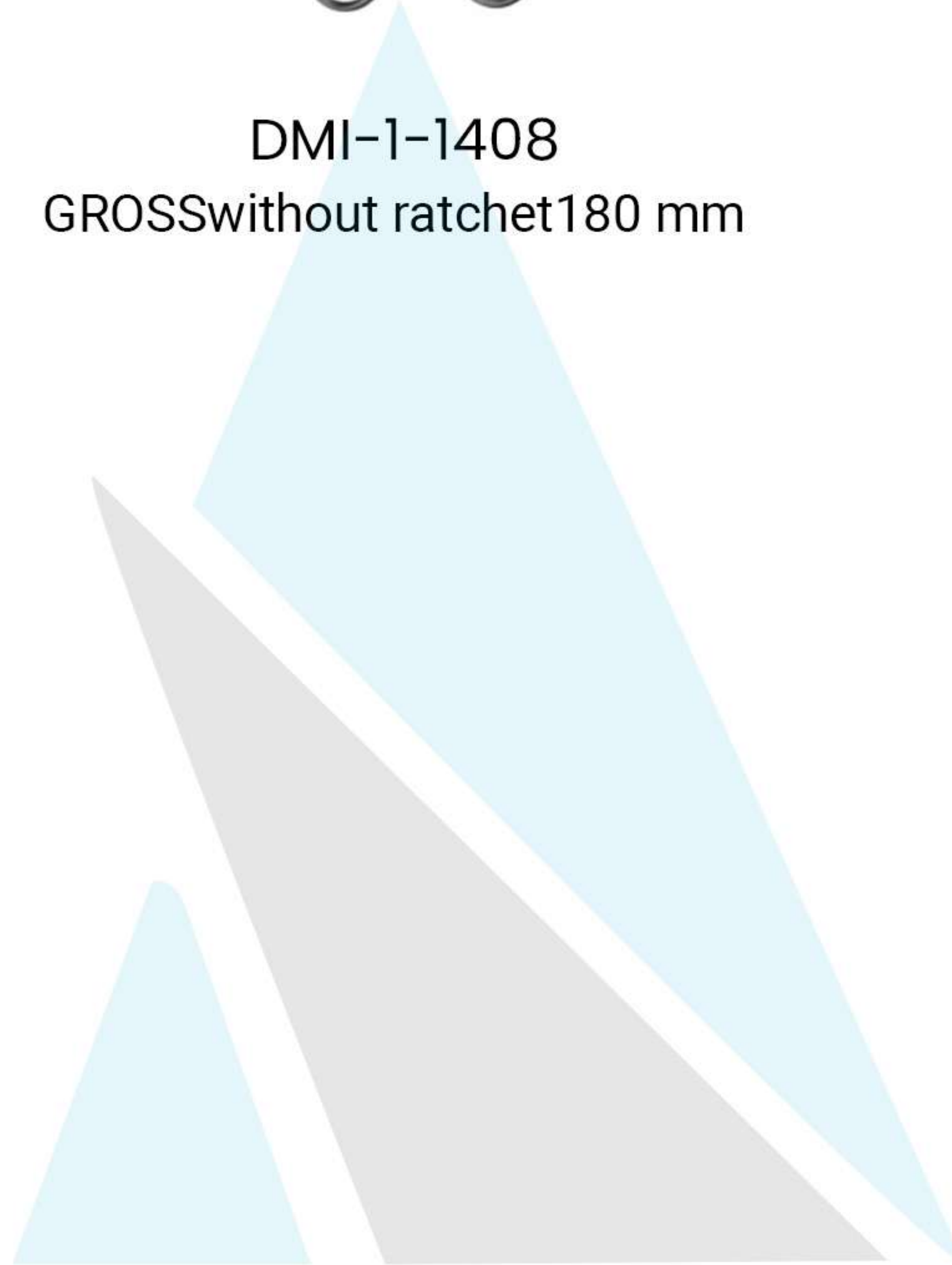

DMI-1-1410
GROSS with ratchet 180 mm

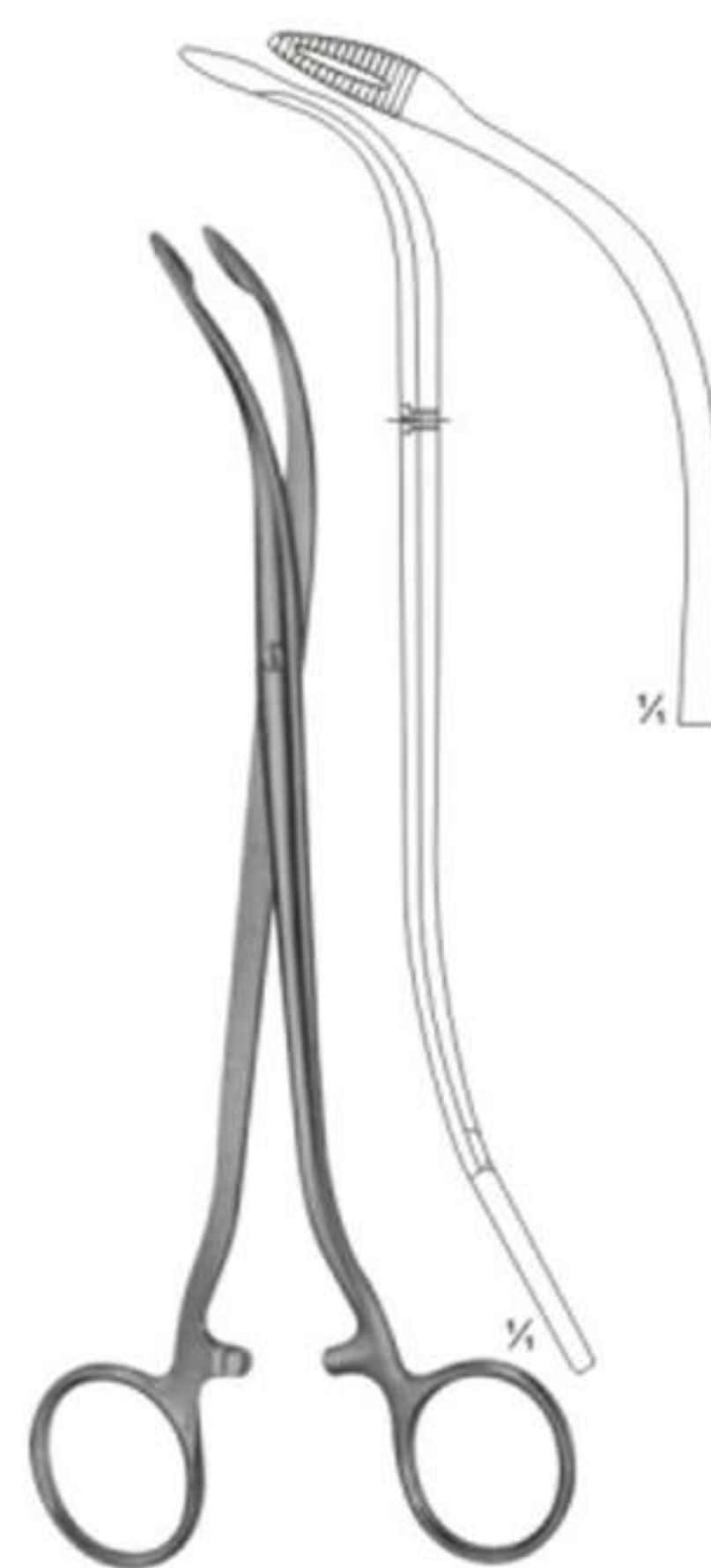

DMI-1-1411
DUPLAY 190 mm

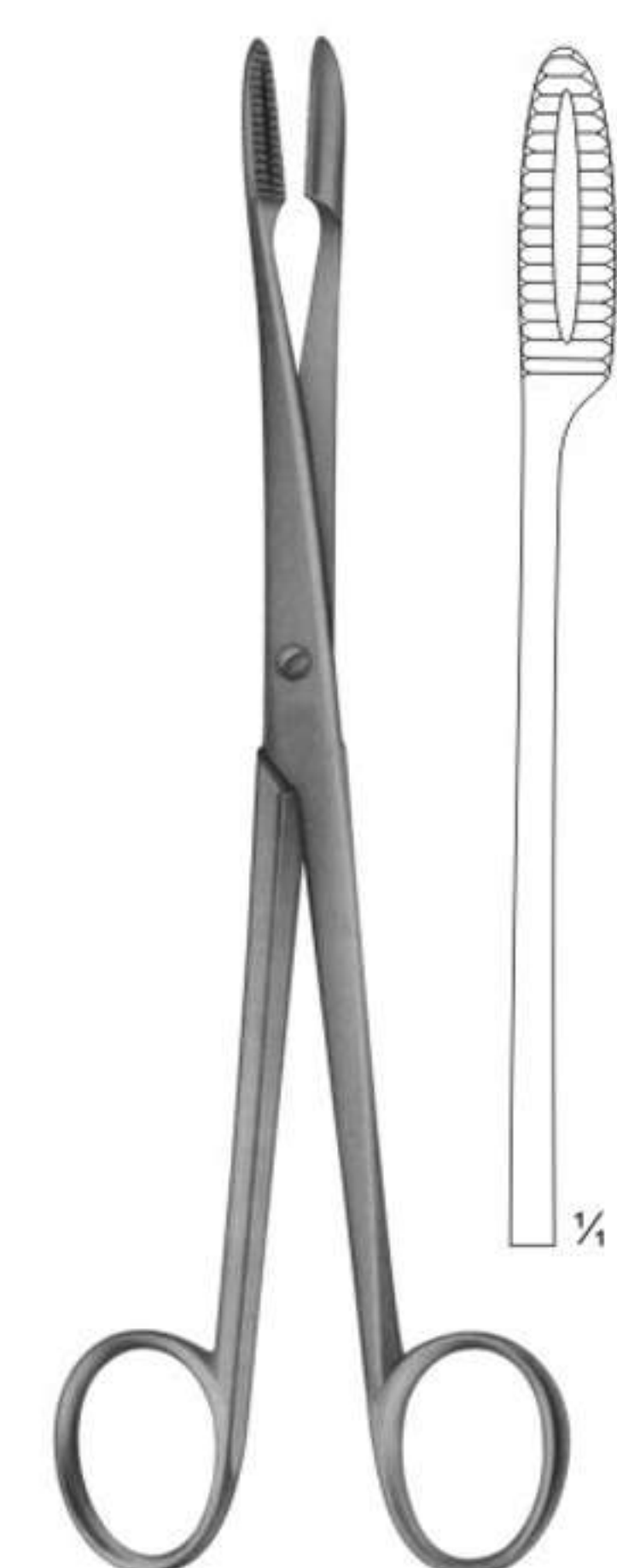

DMI-1-1412
GROSS without ratchet 200 mm

Sponge, Dressing and Tissue Grasping Forceps



DMI-1-1413
GROSS without ratchet 200 mm

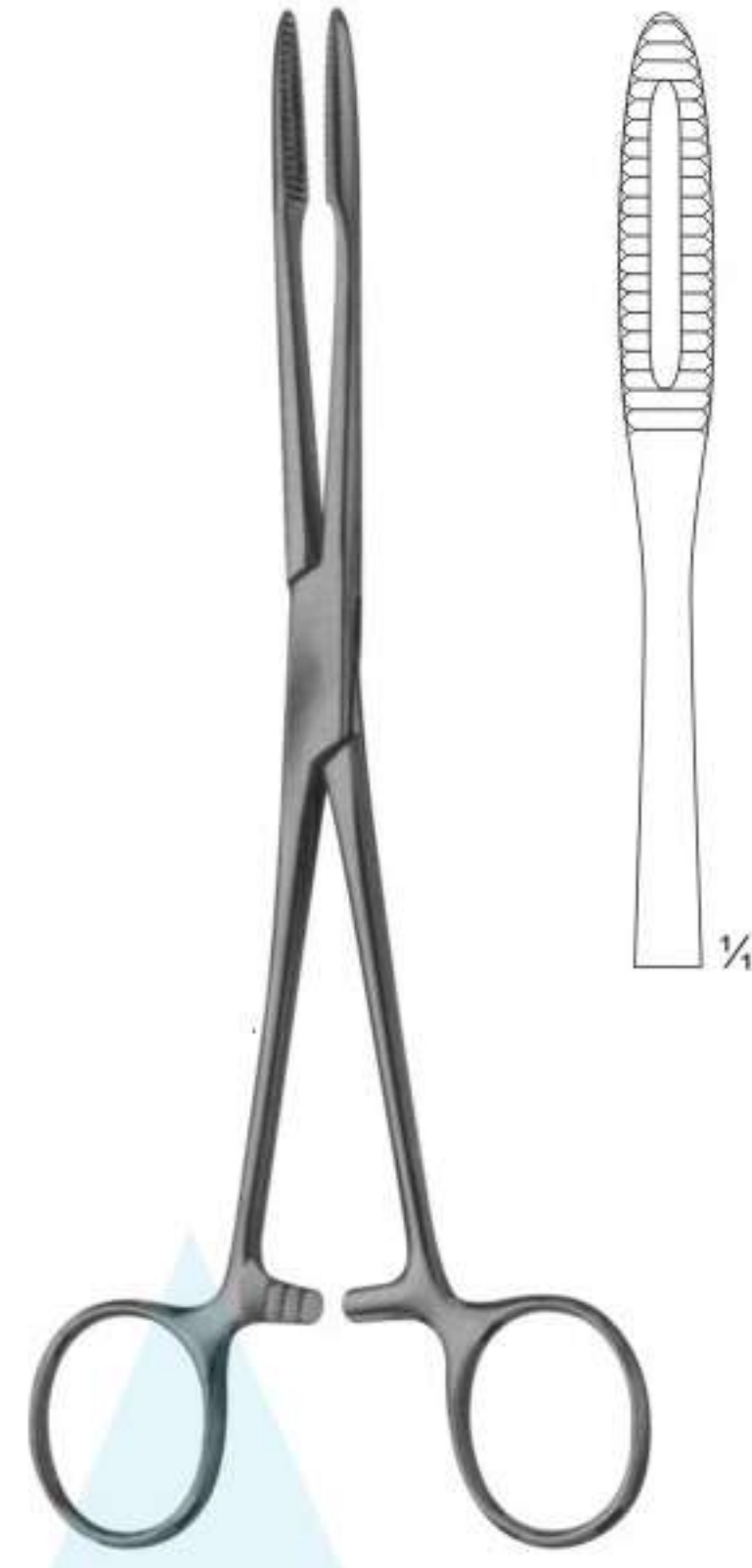

DMI-1-1414
GROSS 200 mm



DMI-1-1415
GROSS 200 mm

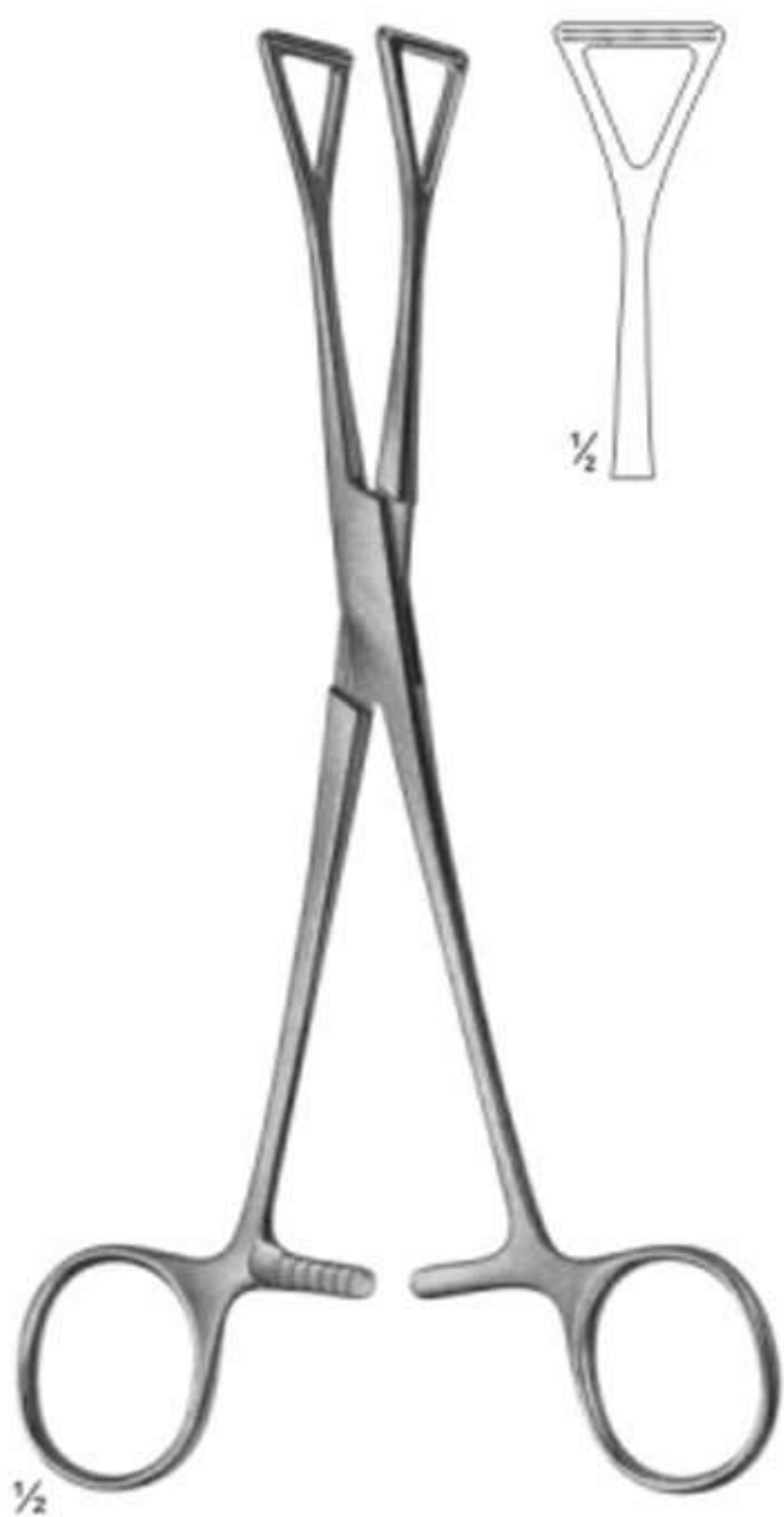

DMI-1-1416
COLLIN 195 mm

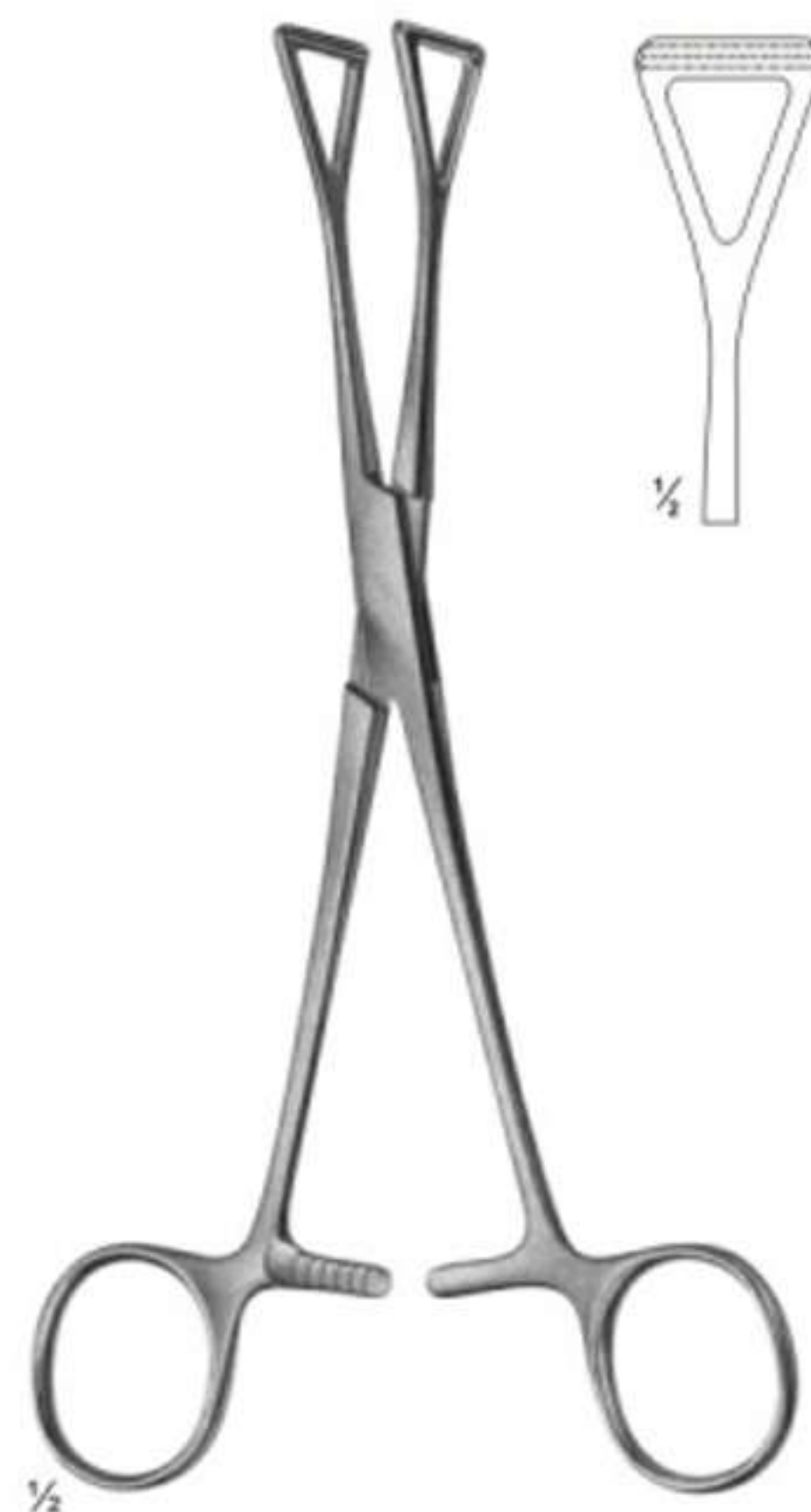

DMI-1-1417
230 mm

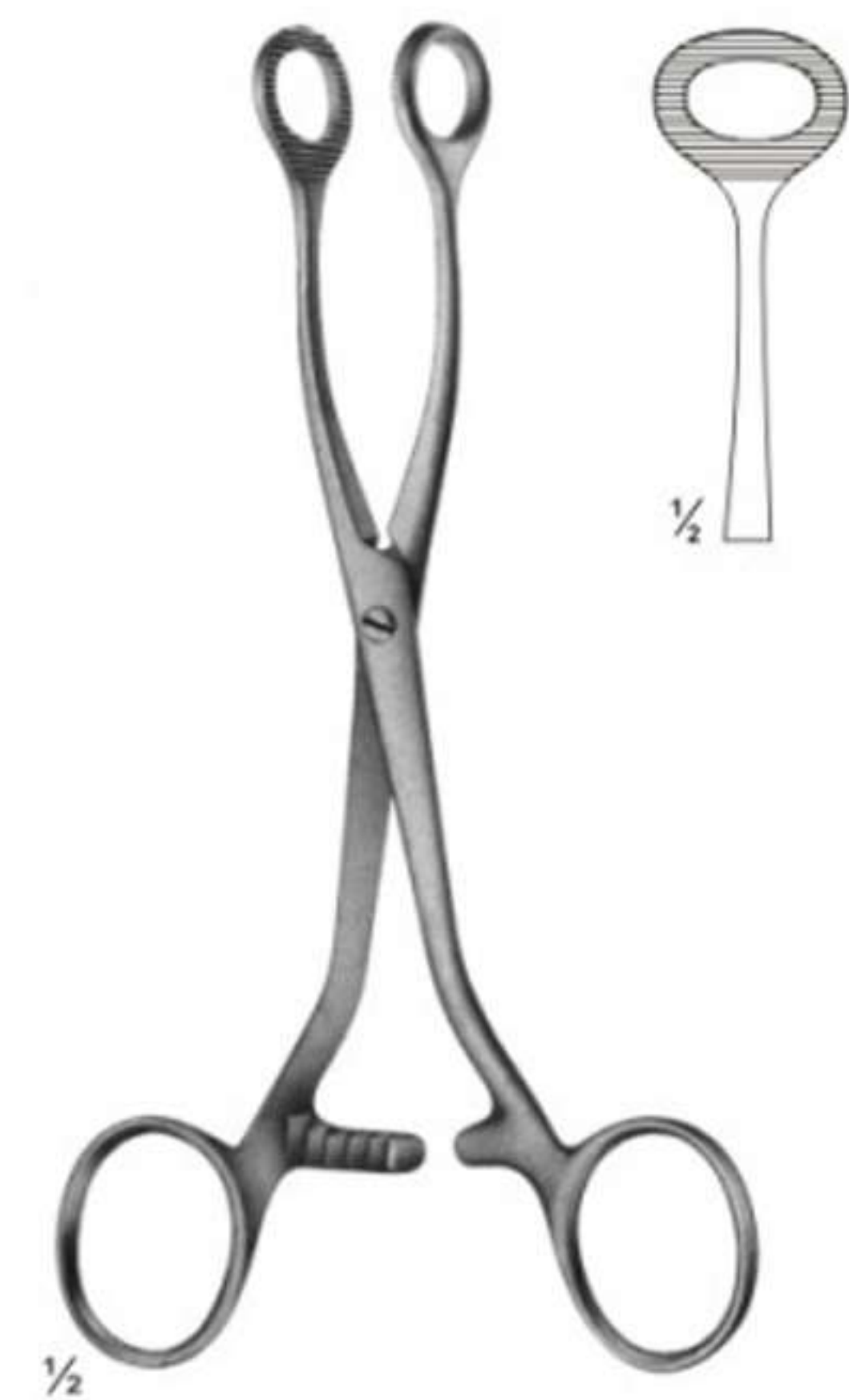

DMI-1-1418
160 mm

Sponge, Dressing and Tissue Grasping Forceps

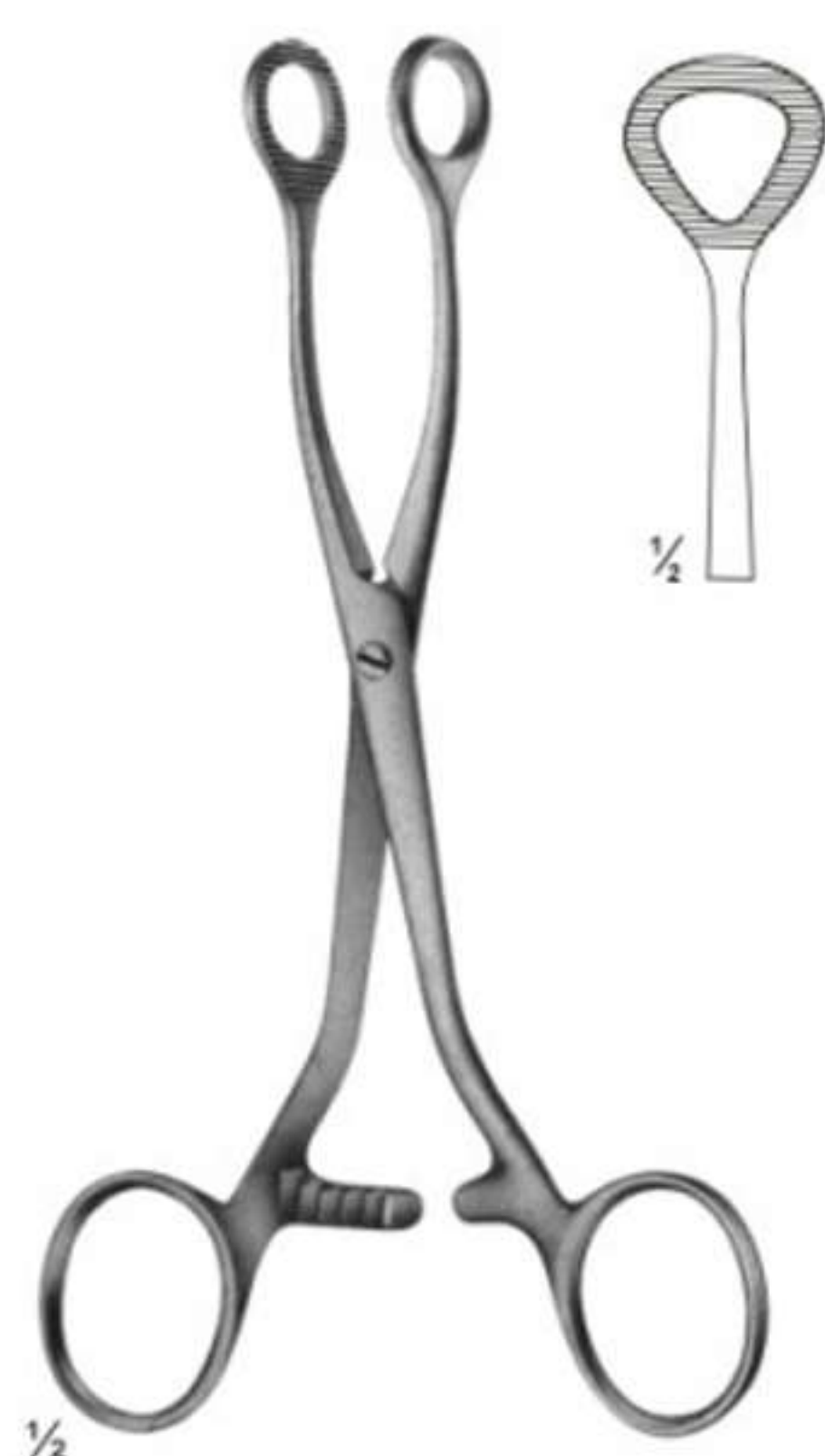

DMI-1-1419
COLLIN 160 mm

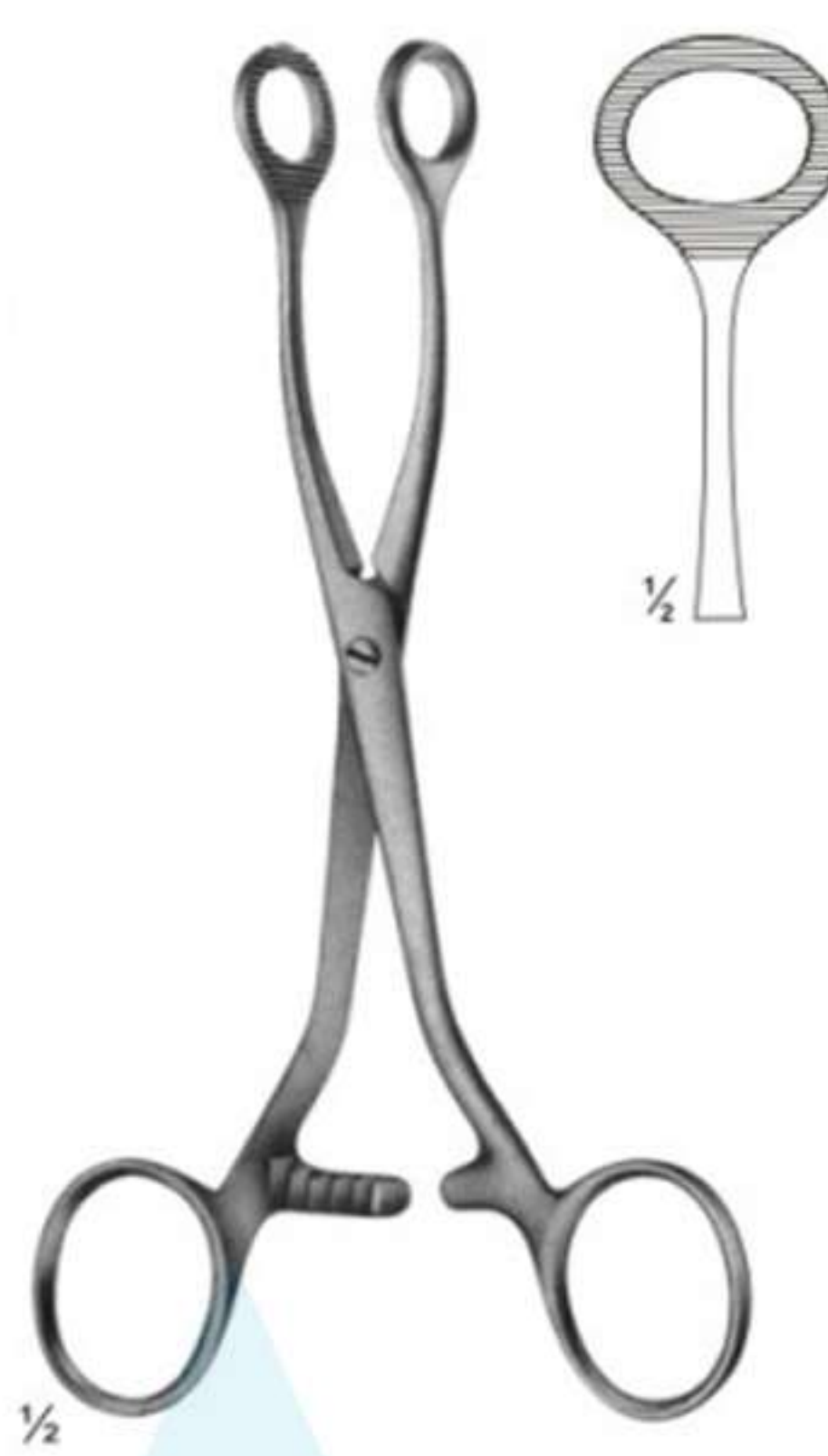

DMI-1-1420
COLLIN 170 mm

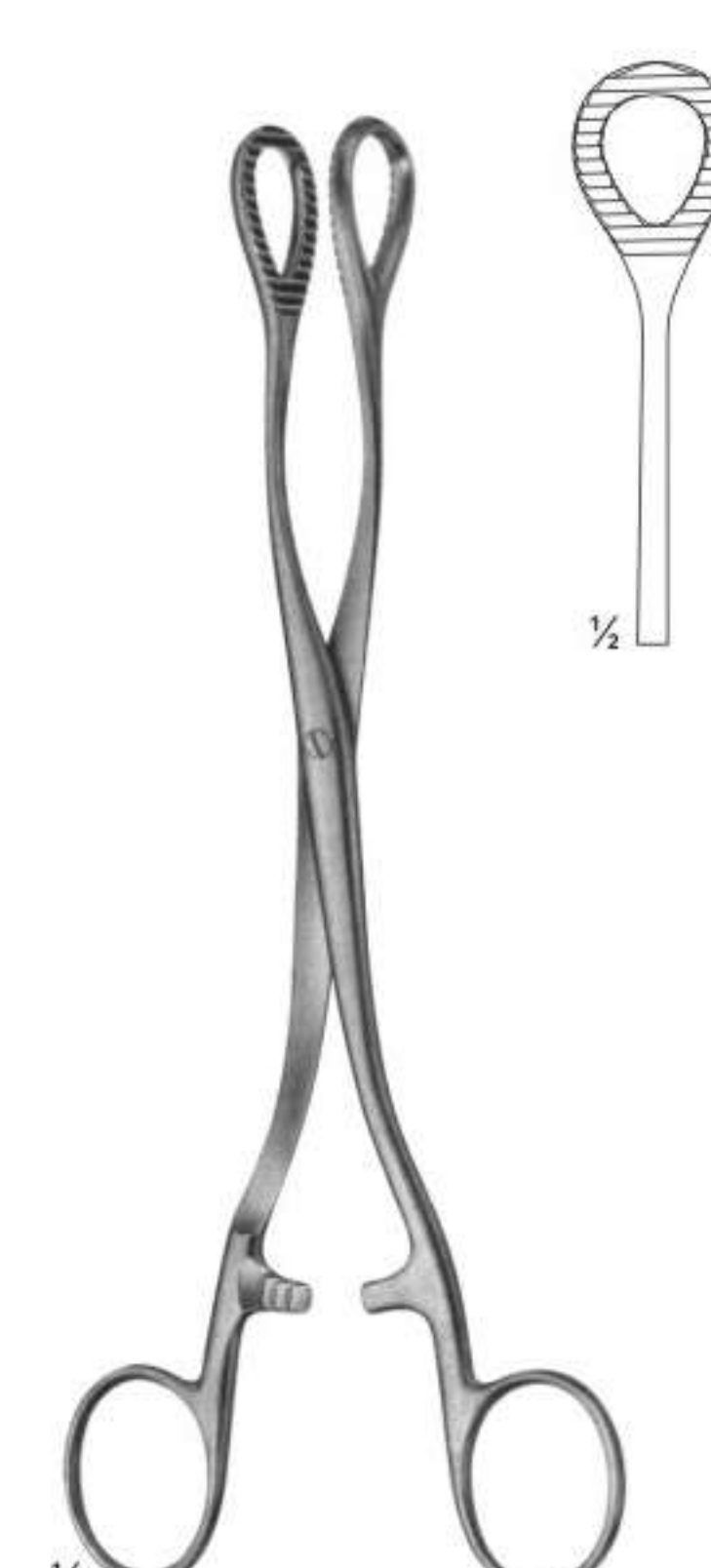

DMI-1-1421
HEYWOOD-SMITH 200 mm

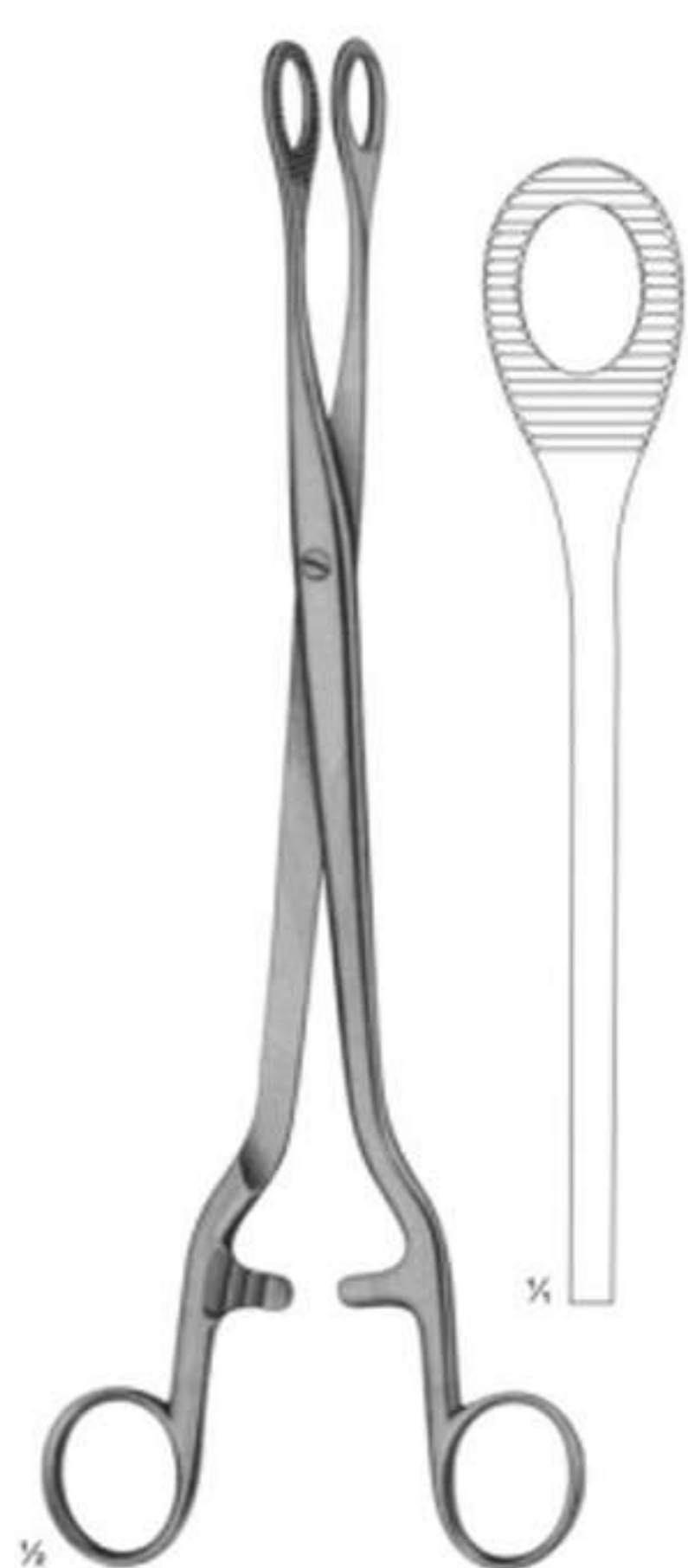
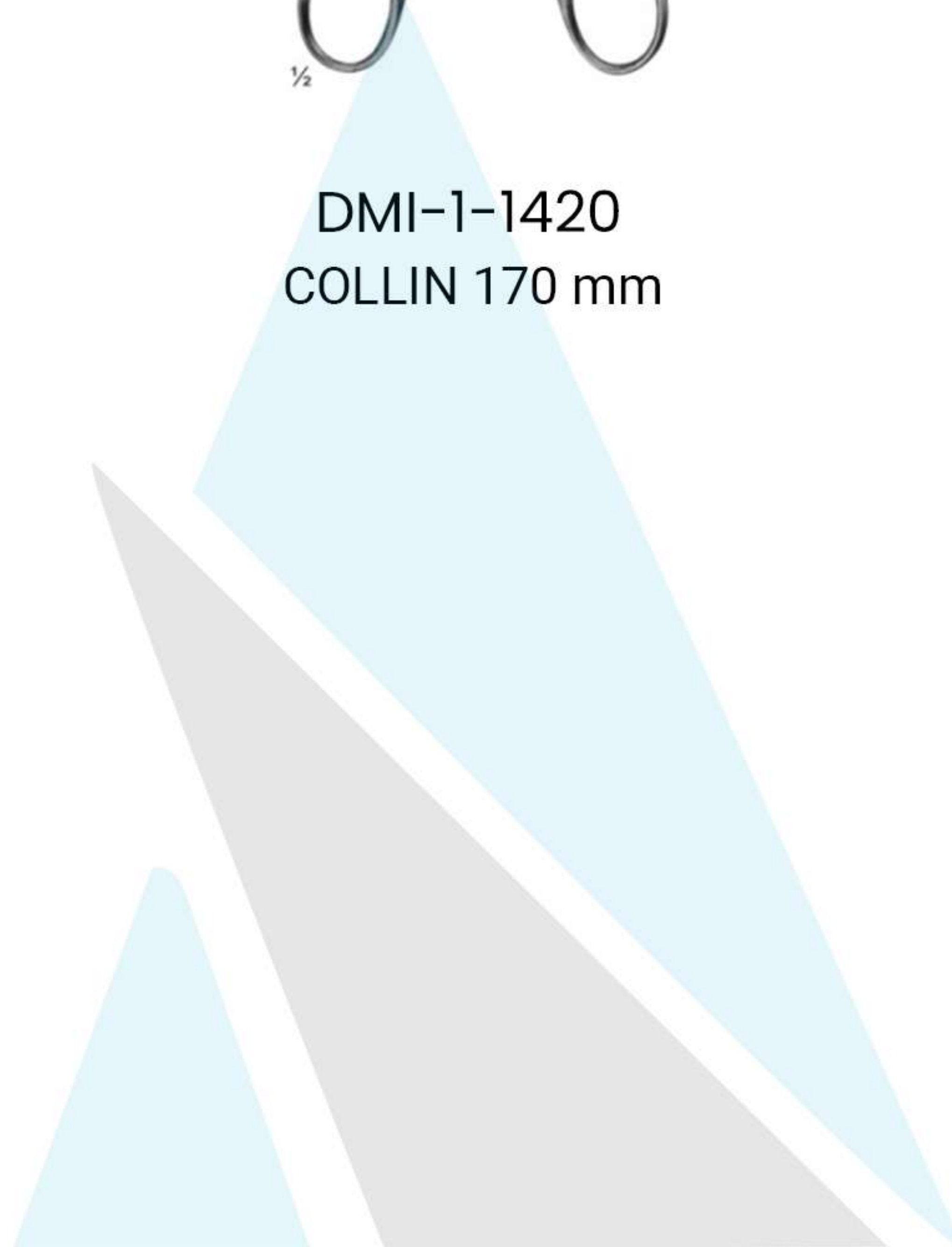

DMI-1-1422
NOTO 280 mm

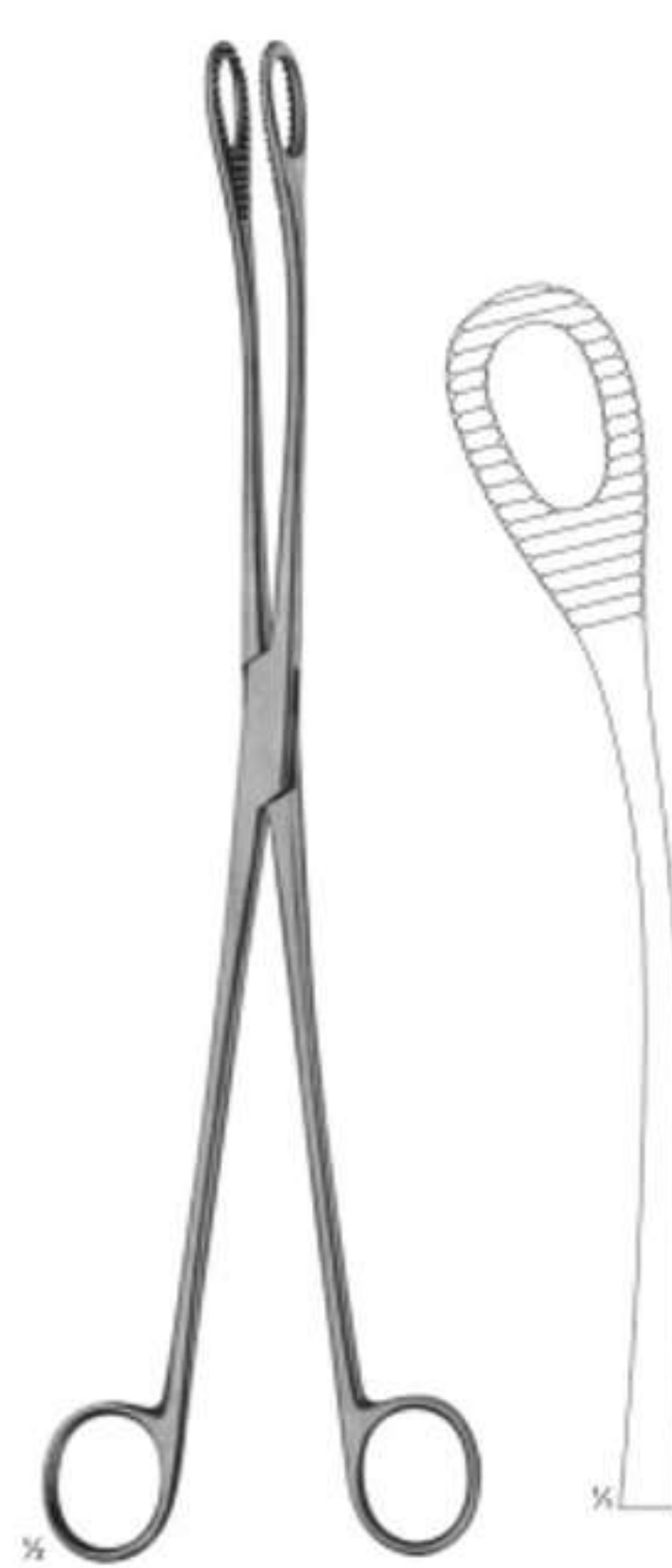

DMI-1-1423
KELLY 320 mm

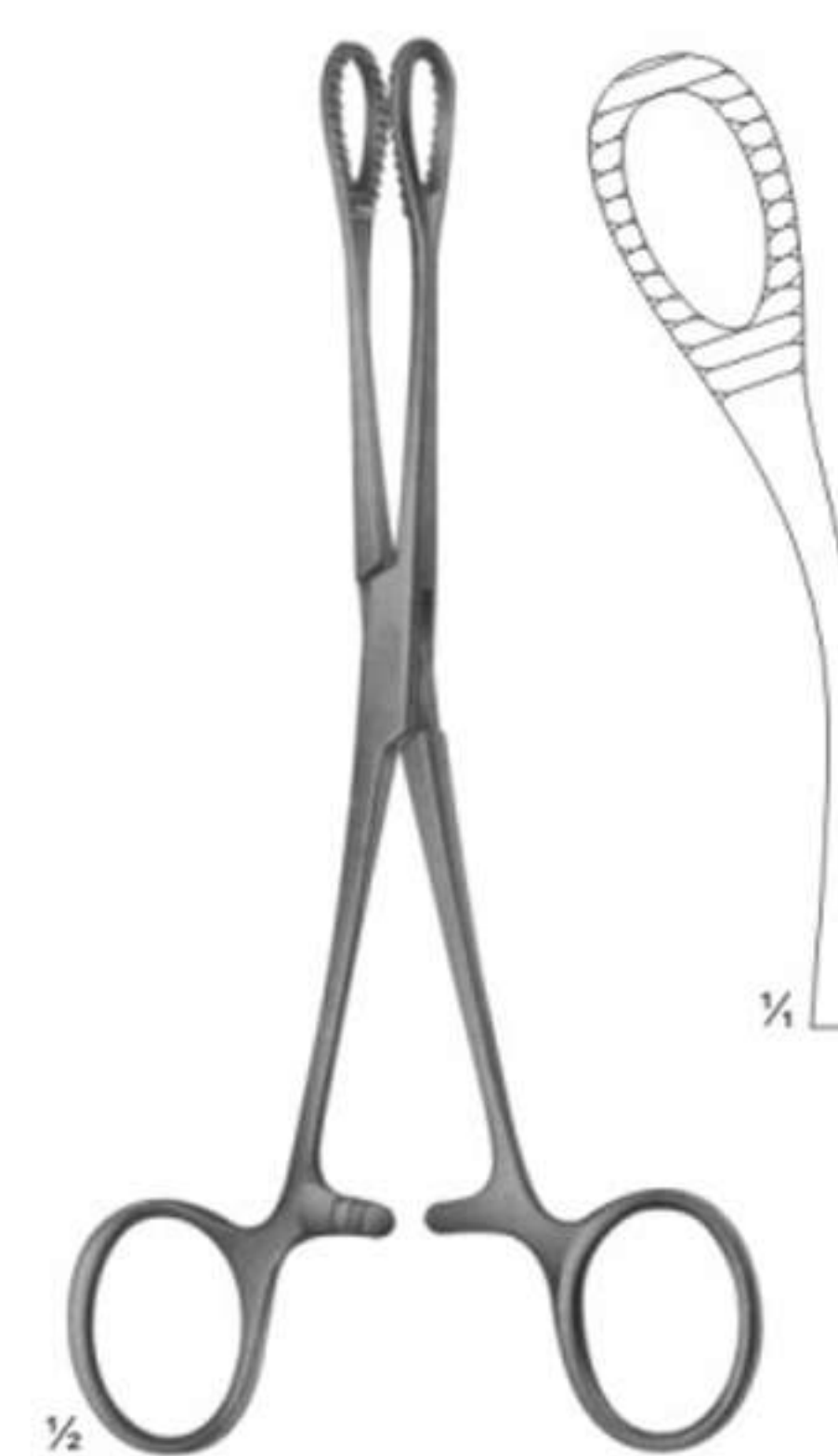

DMI-1-1424
FOERSTER-BALLENGER 180 mm

Sponge, Dressing and Tissue Grasping Forceps

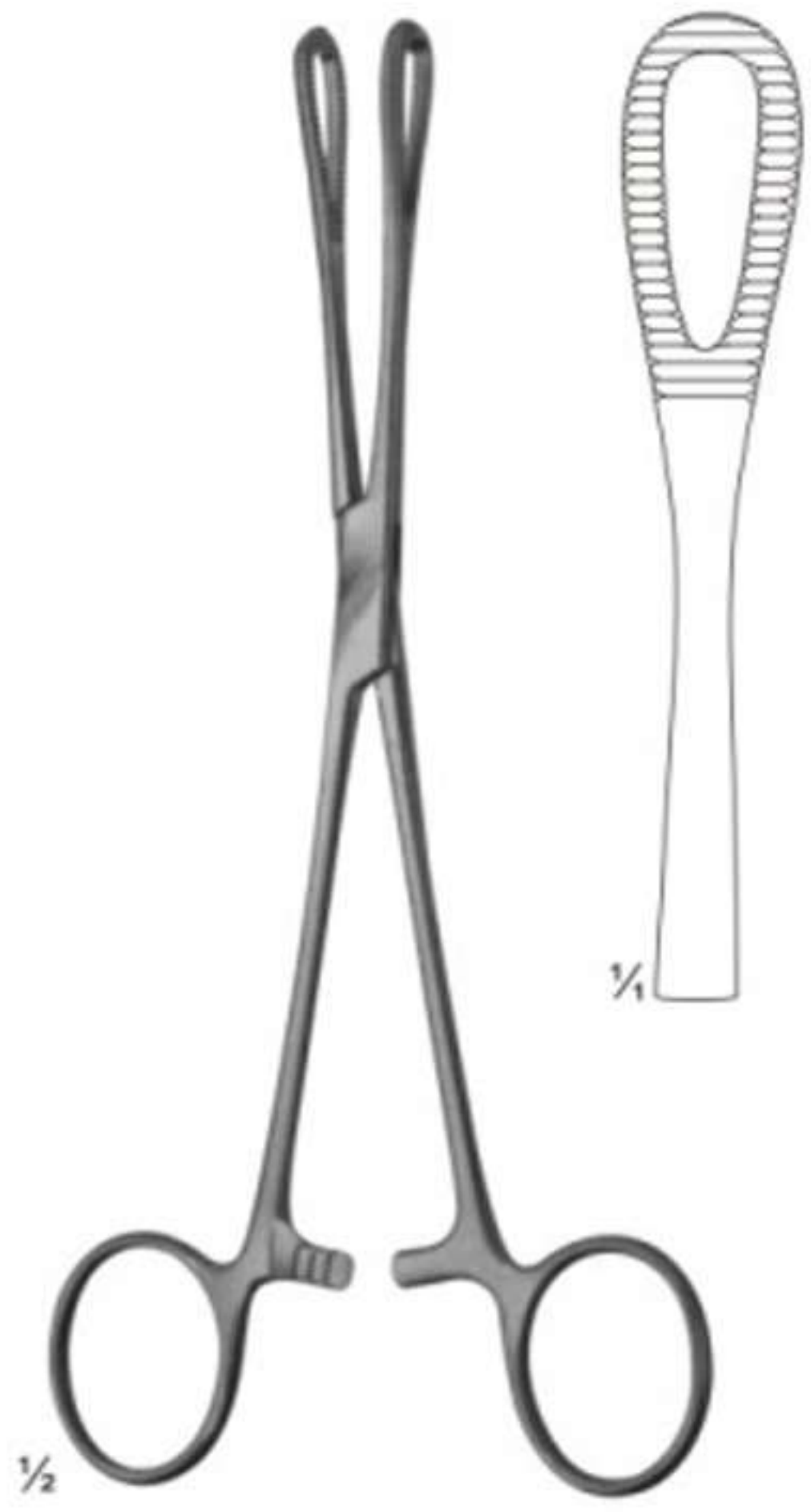

DMI-1-1425
FOERSTER-BALLENGER 180 mm



DMI-1-1426
RAMPLEY 250 mm

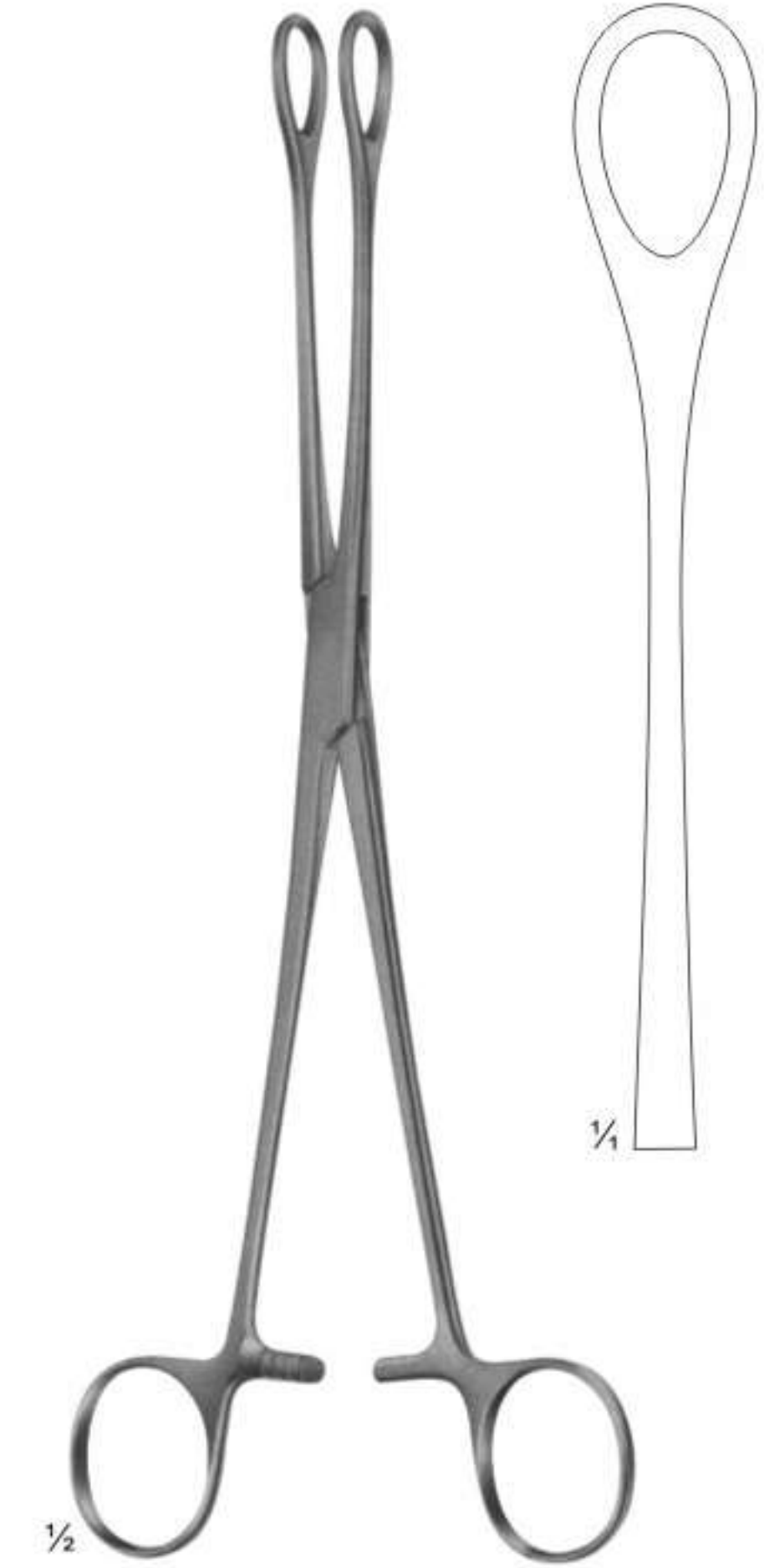

DMI-1-1427
RAMPLEY 250 mm

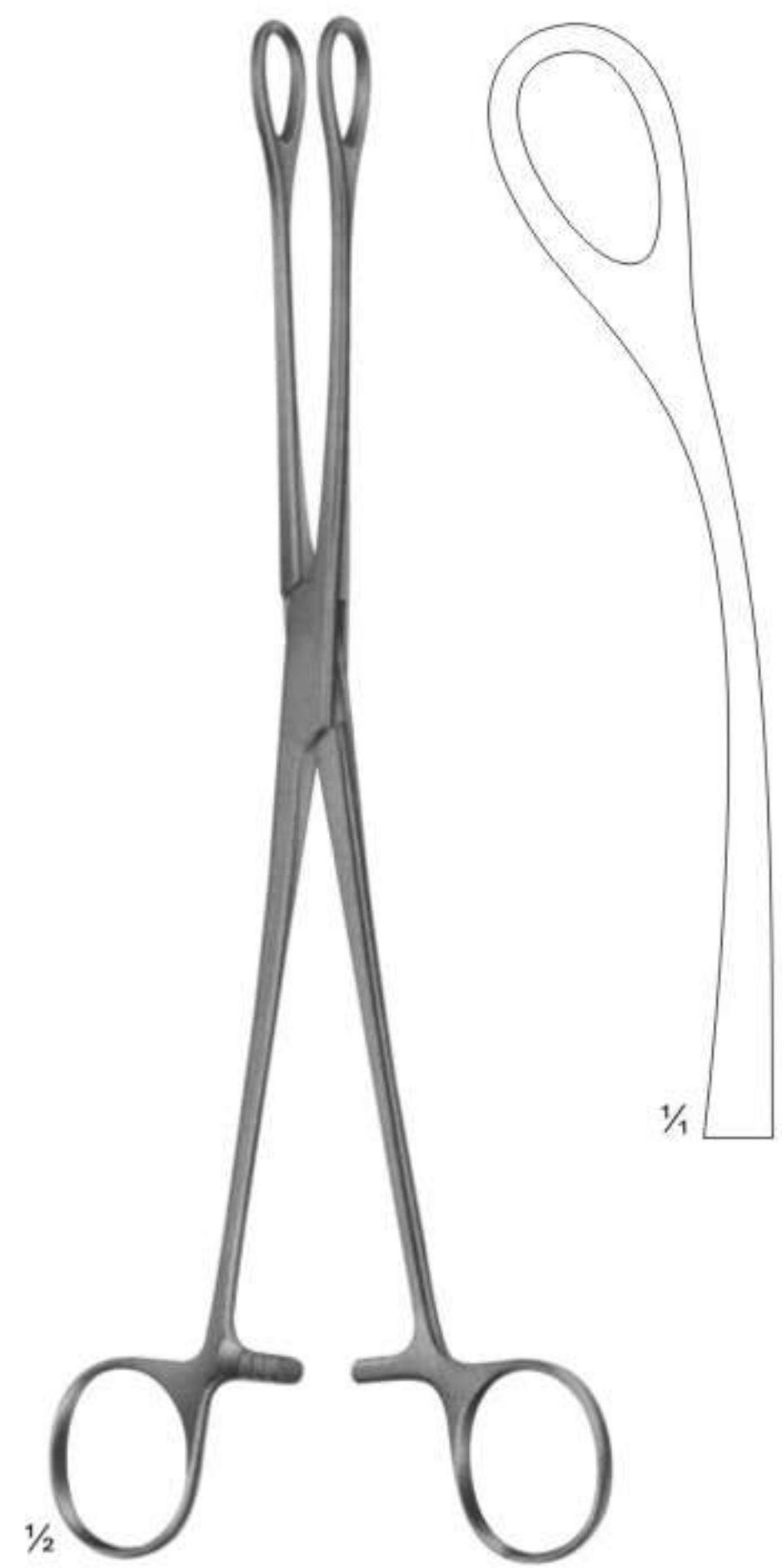

DMI-1-1428
FOERSTER-BALLENGER
240 mm Smooth Jaws

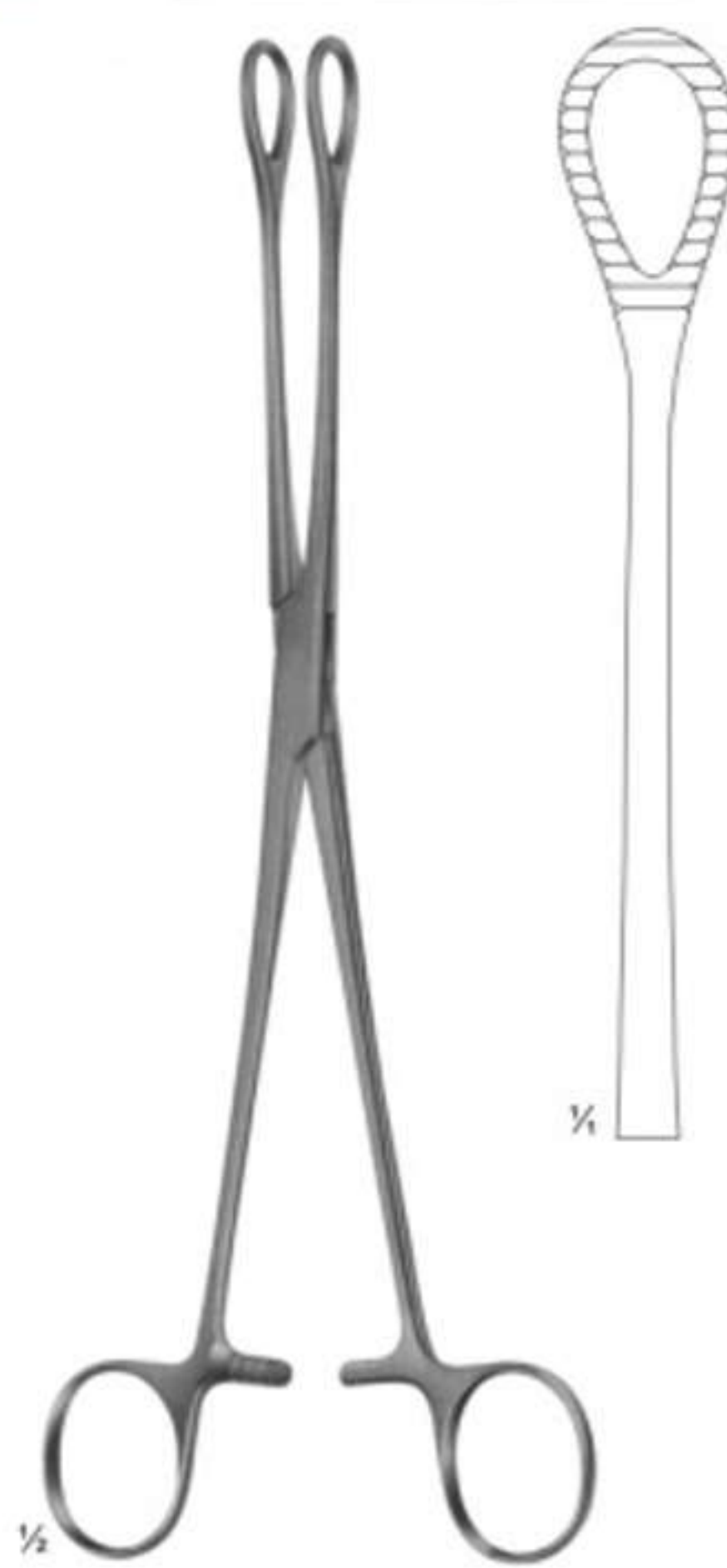

DMI-1-1429
FOERSTER-BALLENGER
240 mm Smooth Jaws

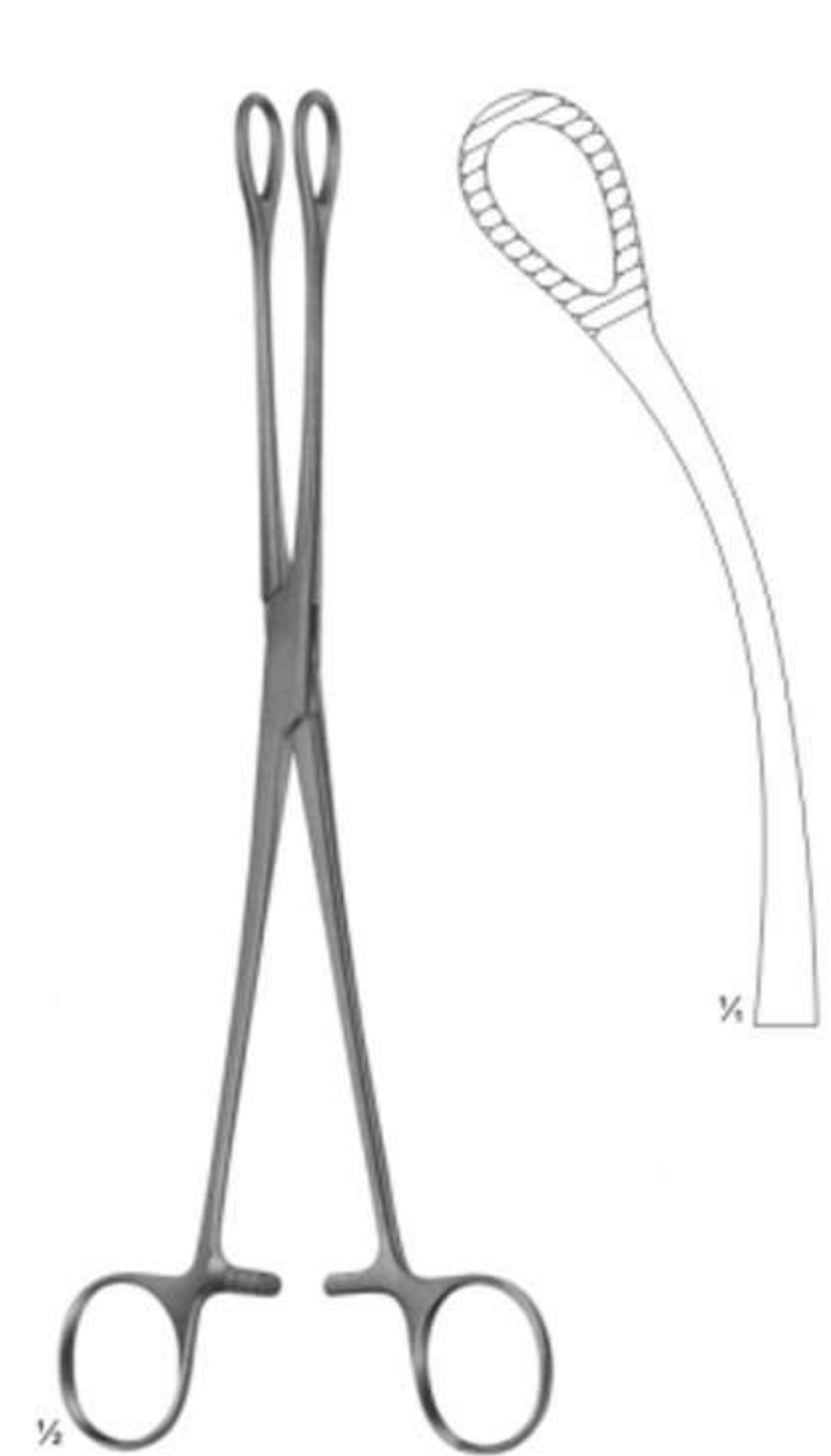

DMI-1-1430
FOERSTER-BALLENGER 240 mm
Serrated Jaws

Sponge, Dressing and Tissue Grasping Forceps

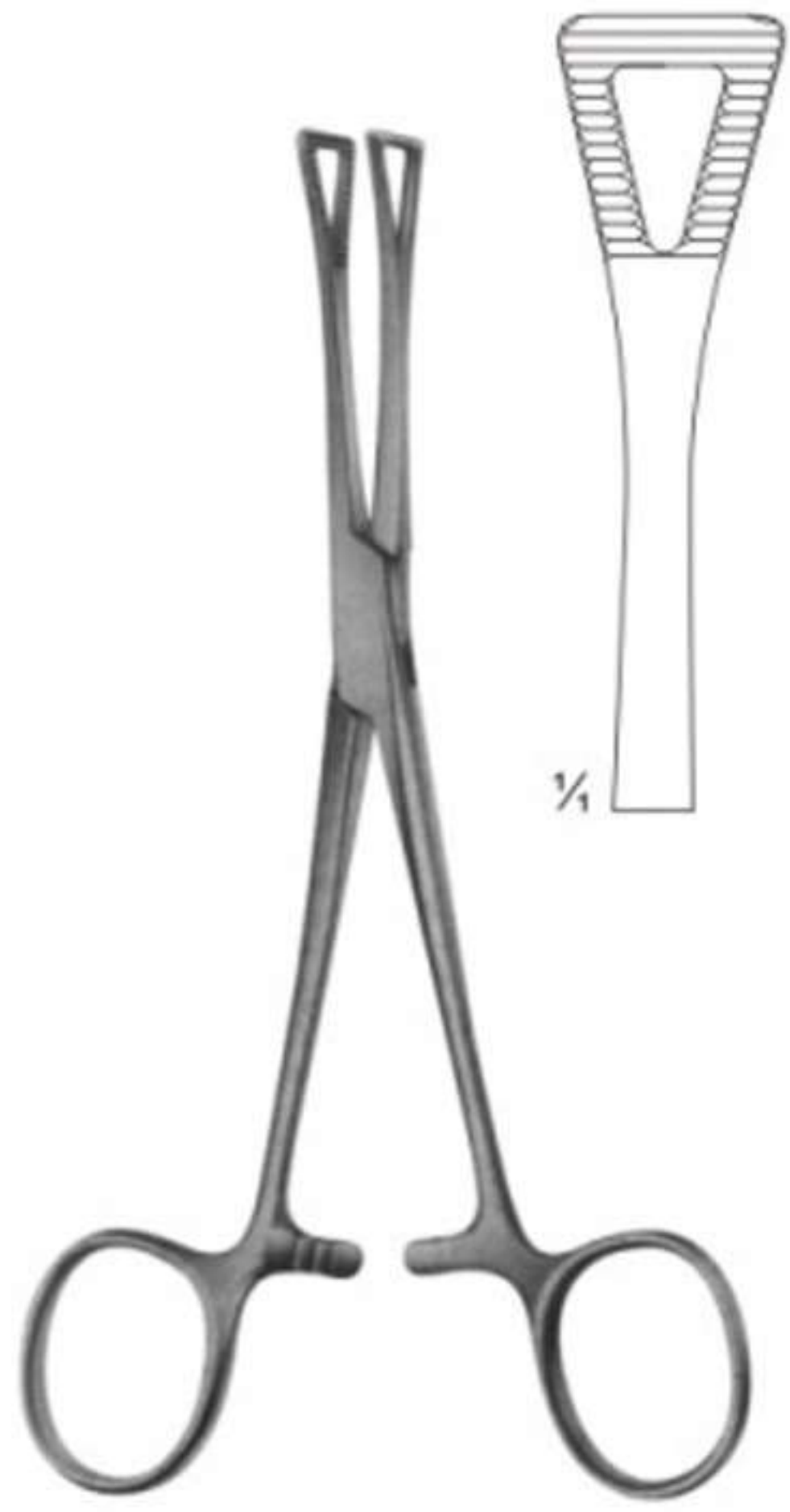

DMI-1-1431
FOERSTER-BALLENGER
240 mm Serrated Jaws

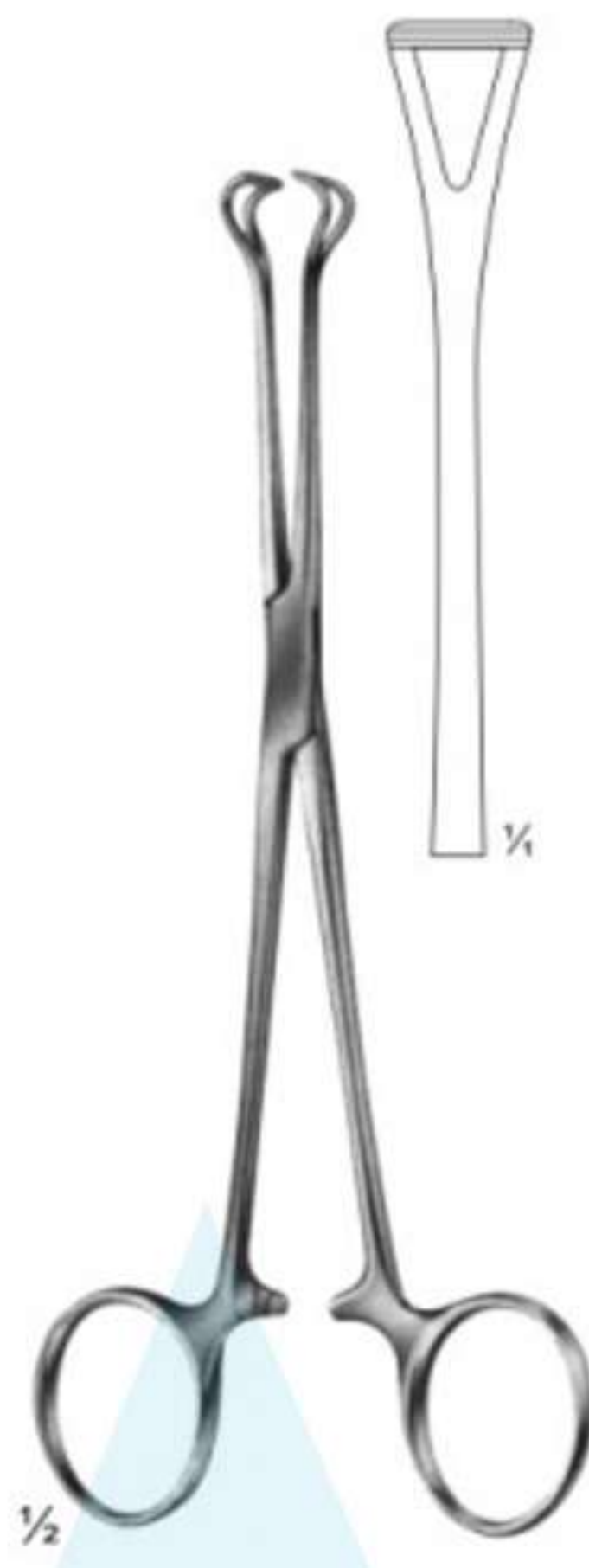

DMI-1-1432
PENNINGTON 155 mm

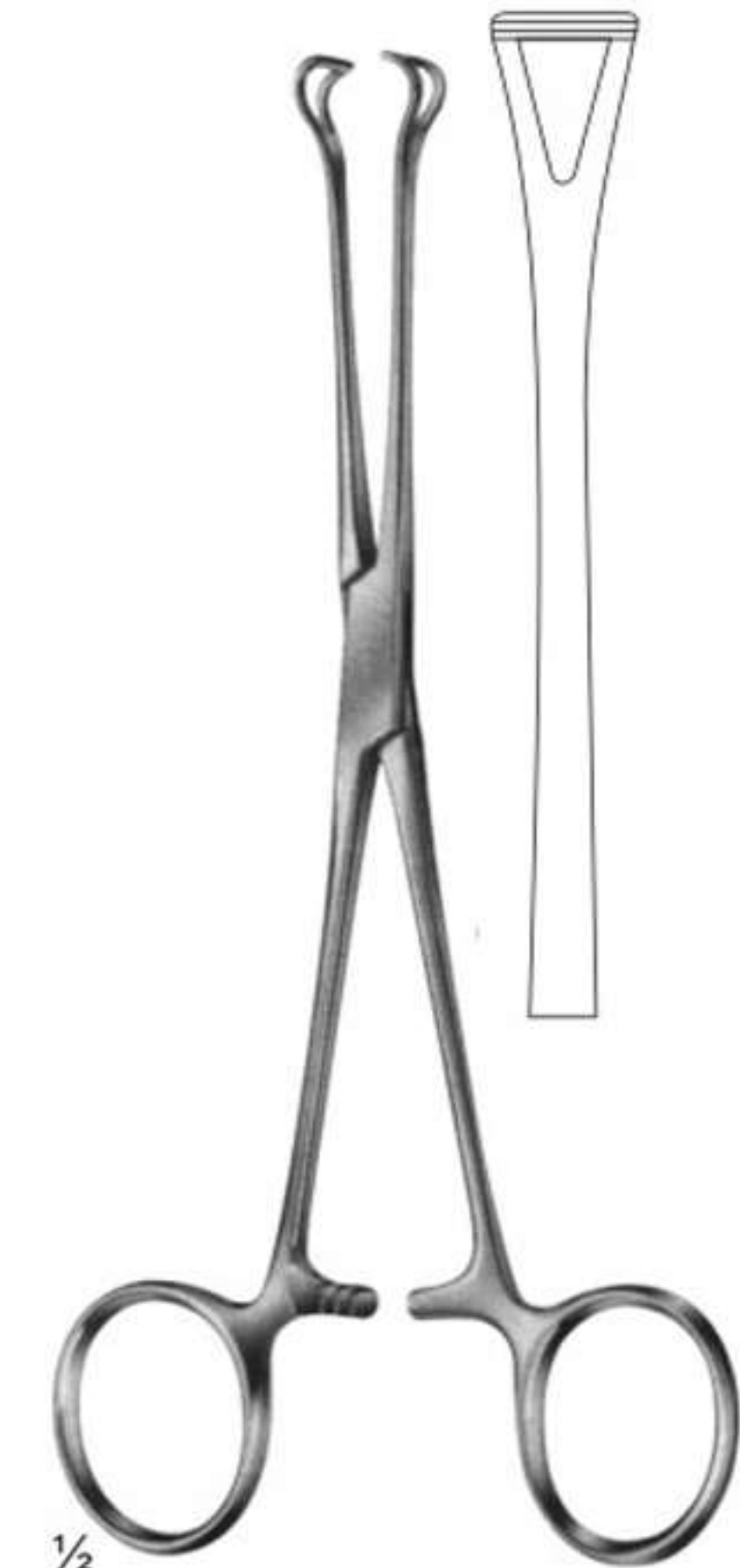

DMI-1-1433
BABCOCK 155 mm

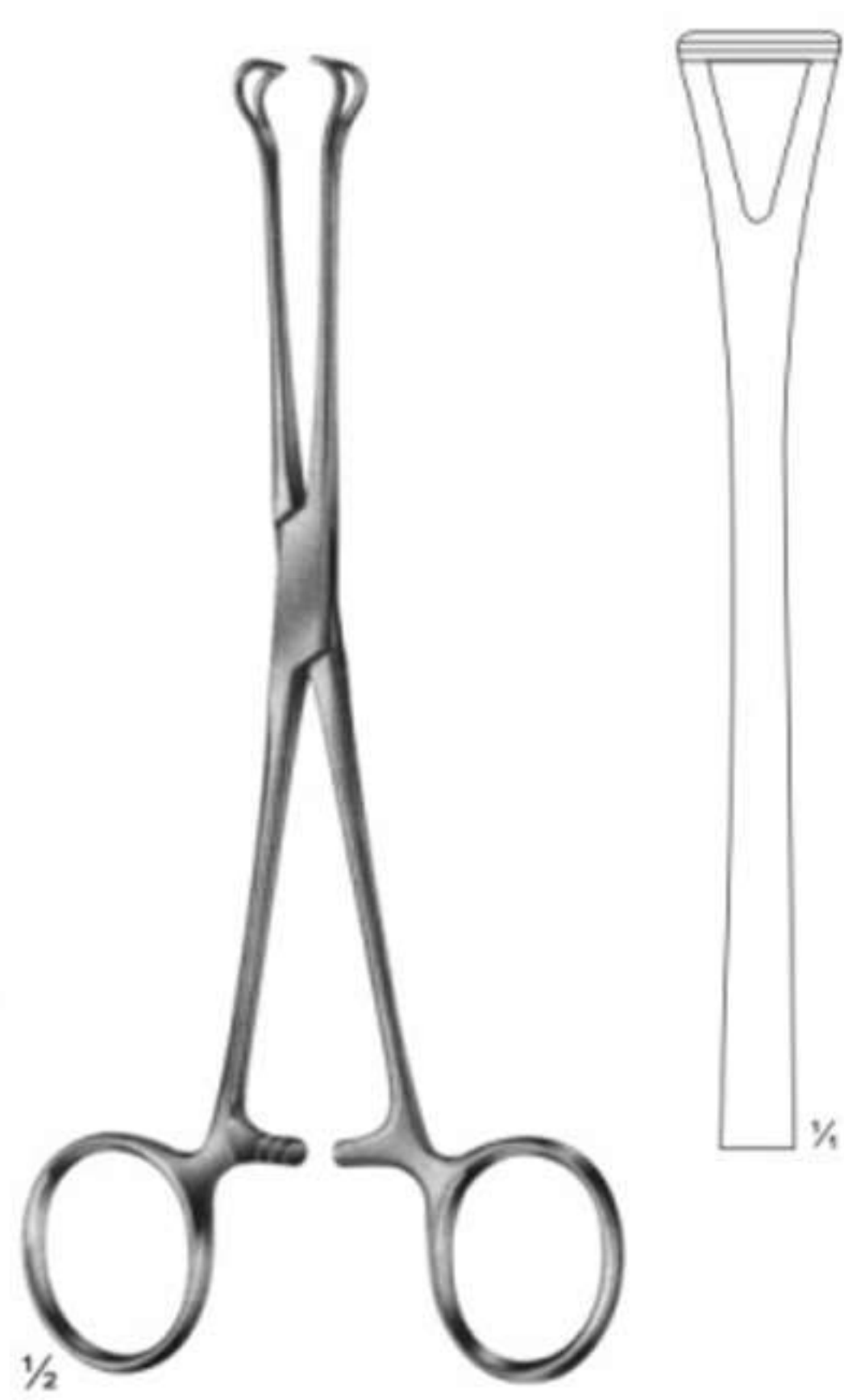

DMI-1-1434
BABCOCK 170 mmv



DMI-1-1435
BABCOCK 215 mm

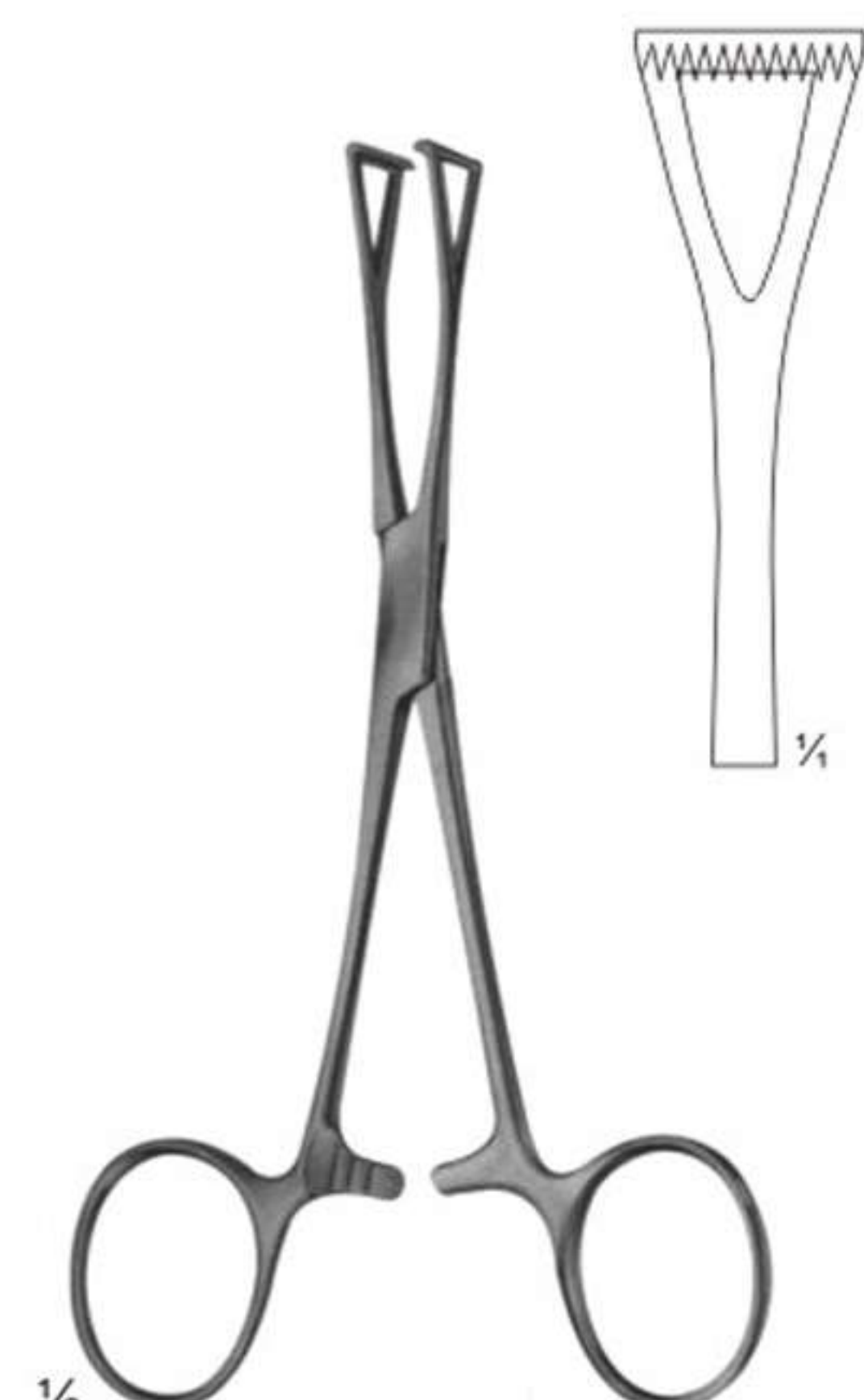

DMI-1-1436
BABCOCK 220 mm

Sponge, Dressing and Tissue Grasping Forceps

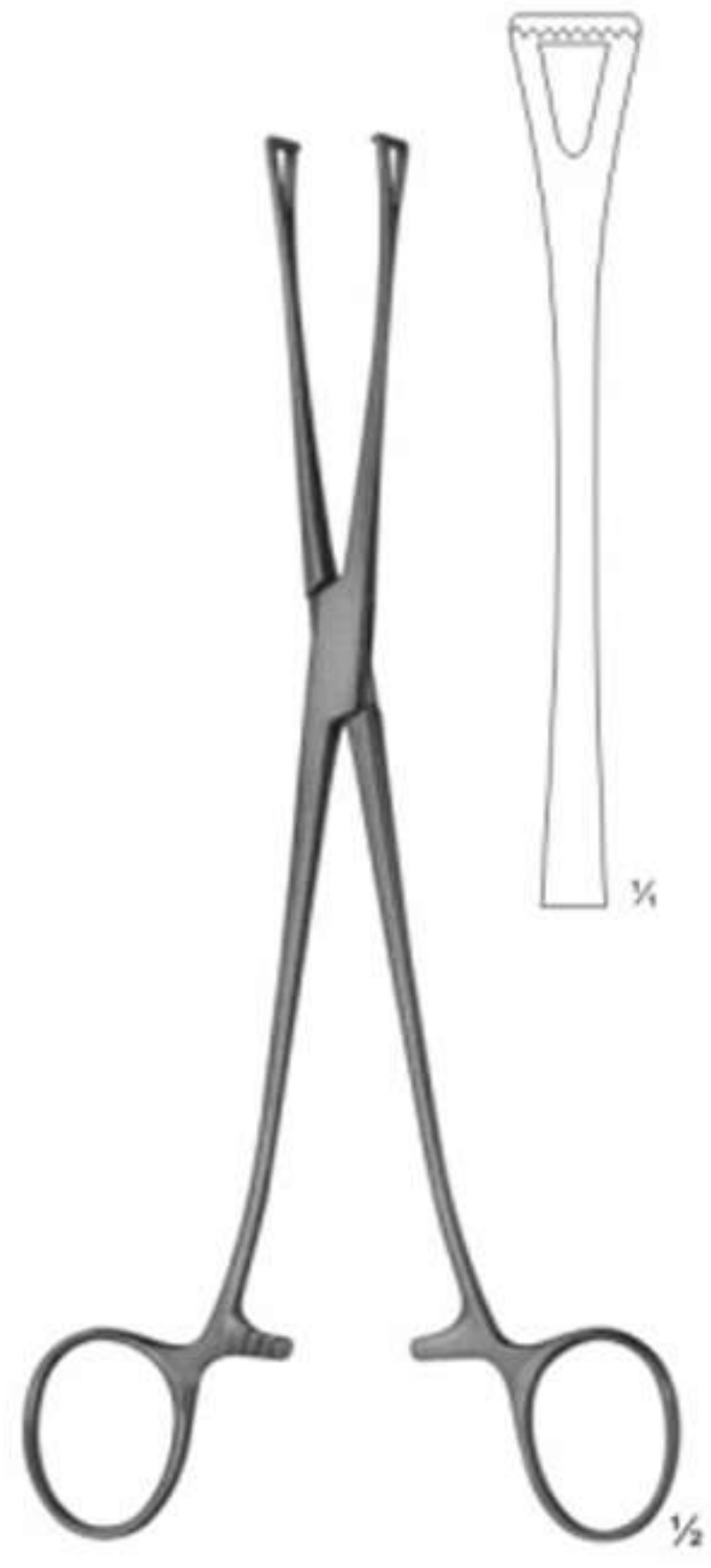

DMI-1-1437
COLLIN 140 mm,

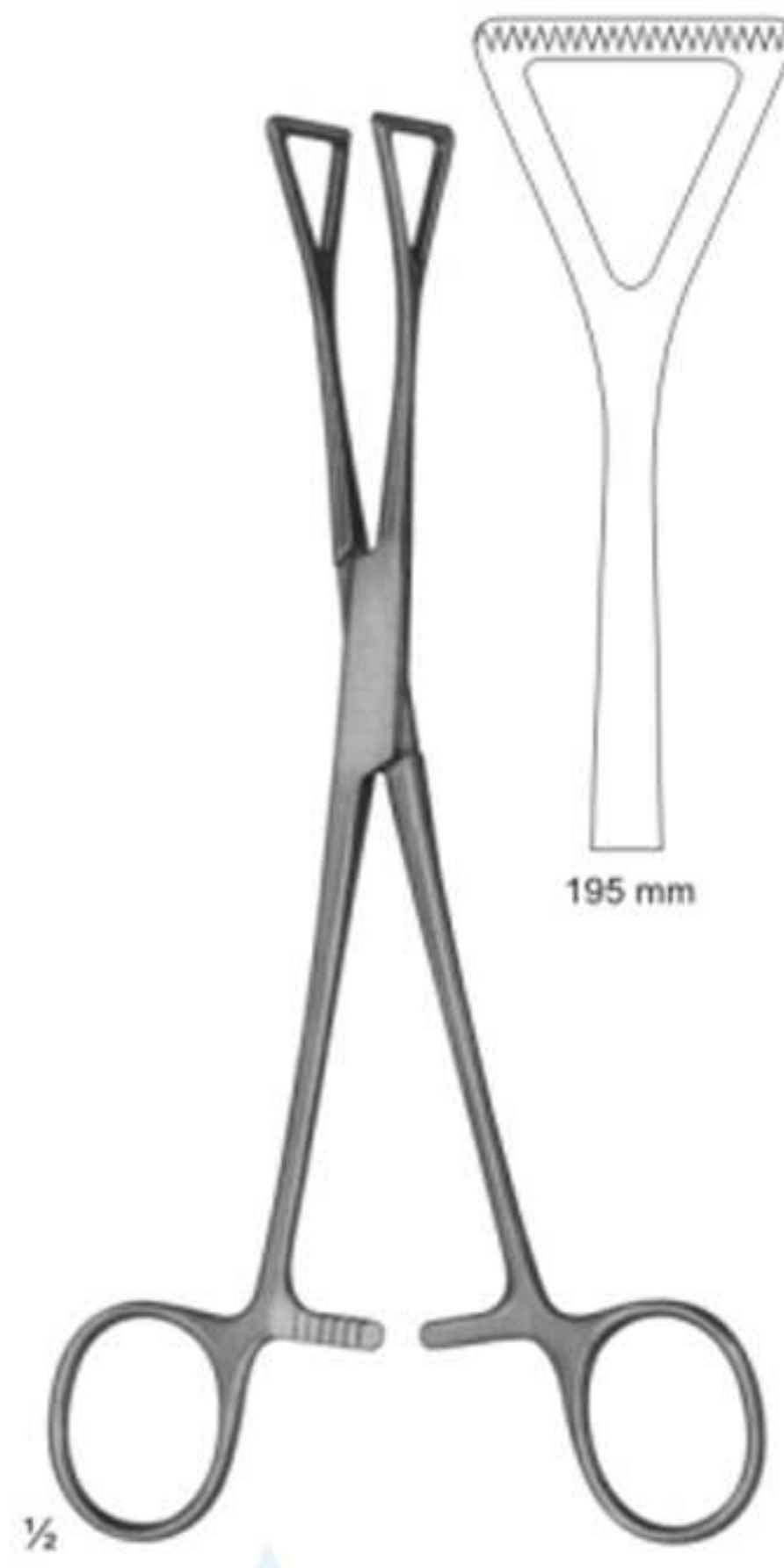

DMIDMI-1-1438
LOCKWOOD 200 mm,

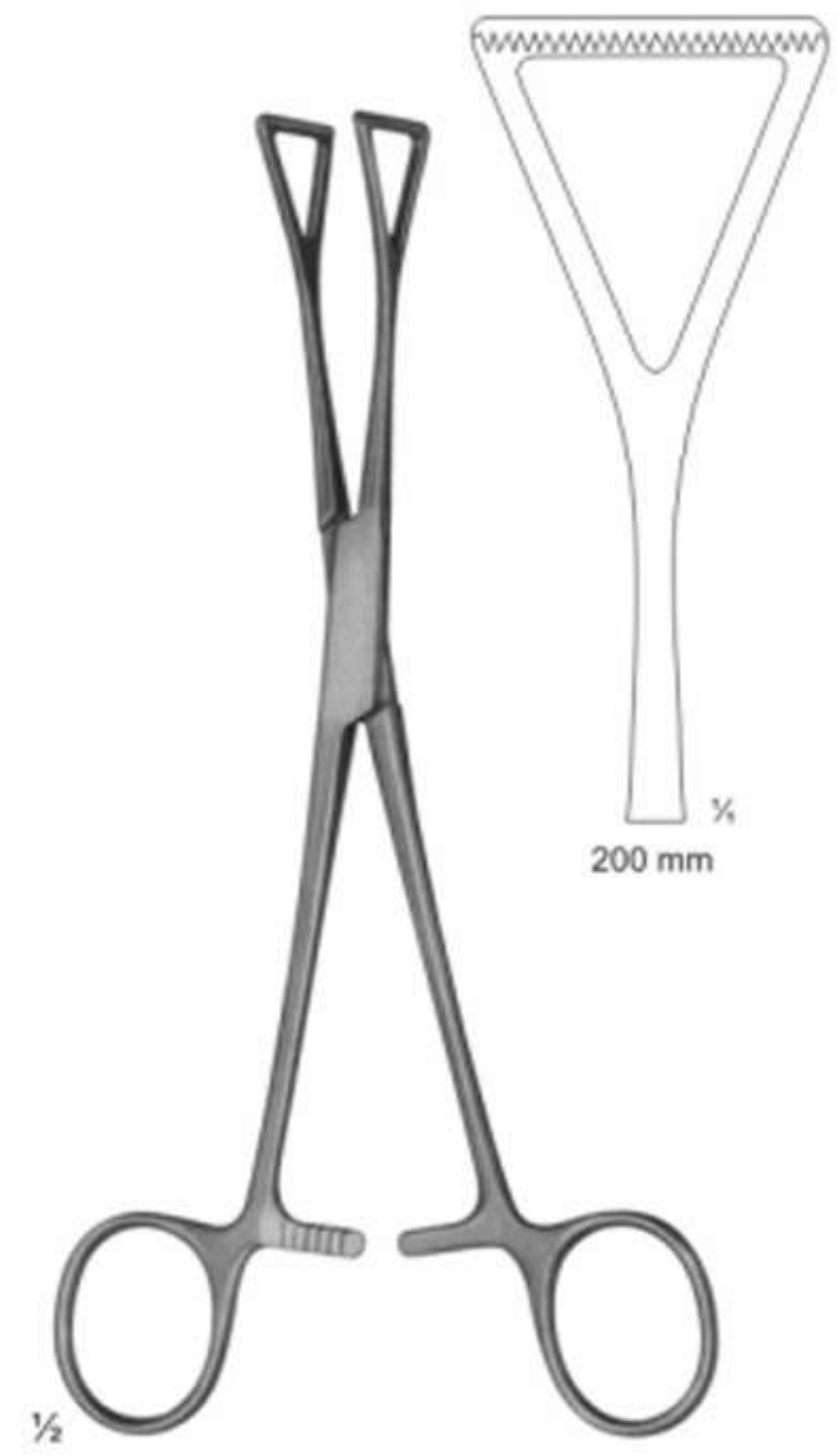

DMI-1-1439
DUVAL-COLLIN 195 mm

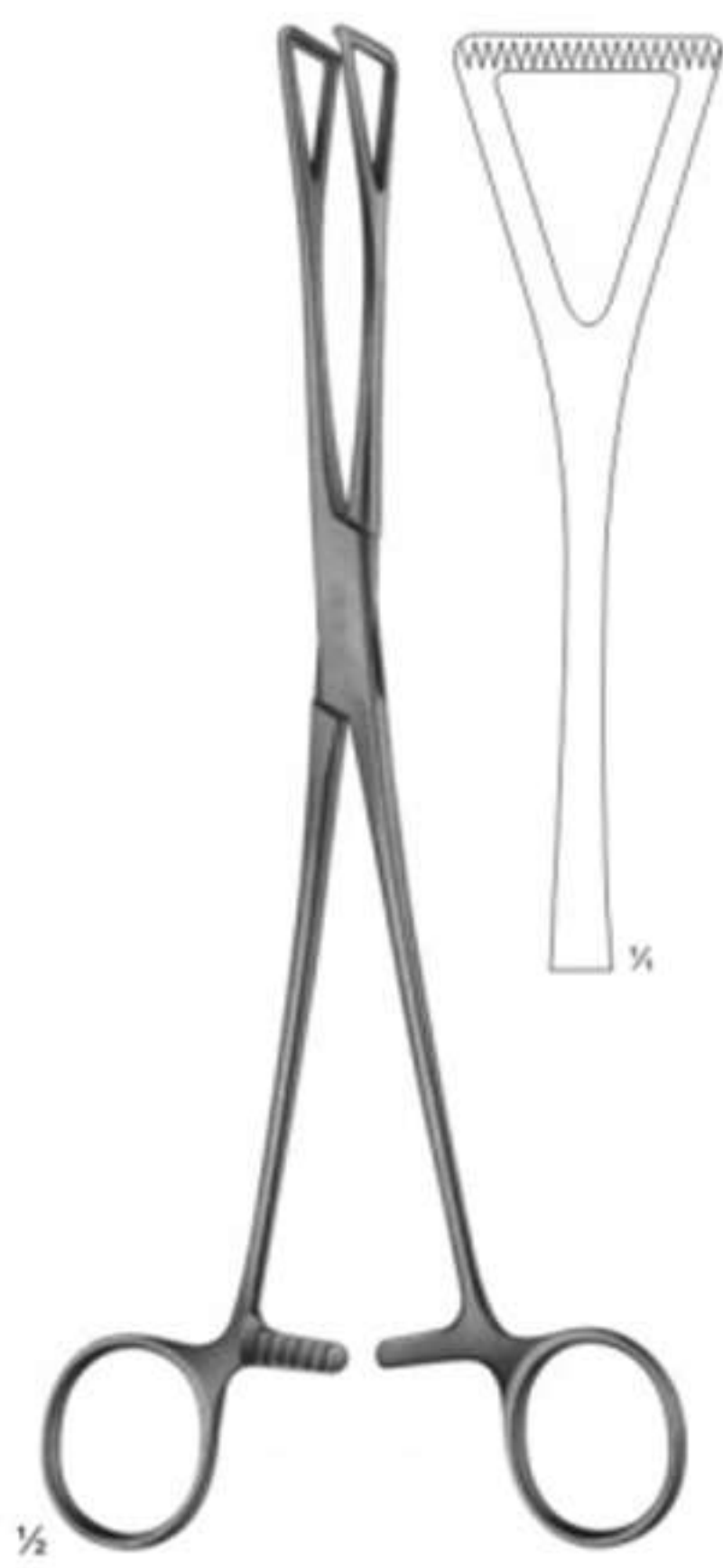

DMI-1-1440
DUVAL-COLLIN 200 mm

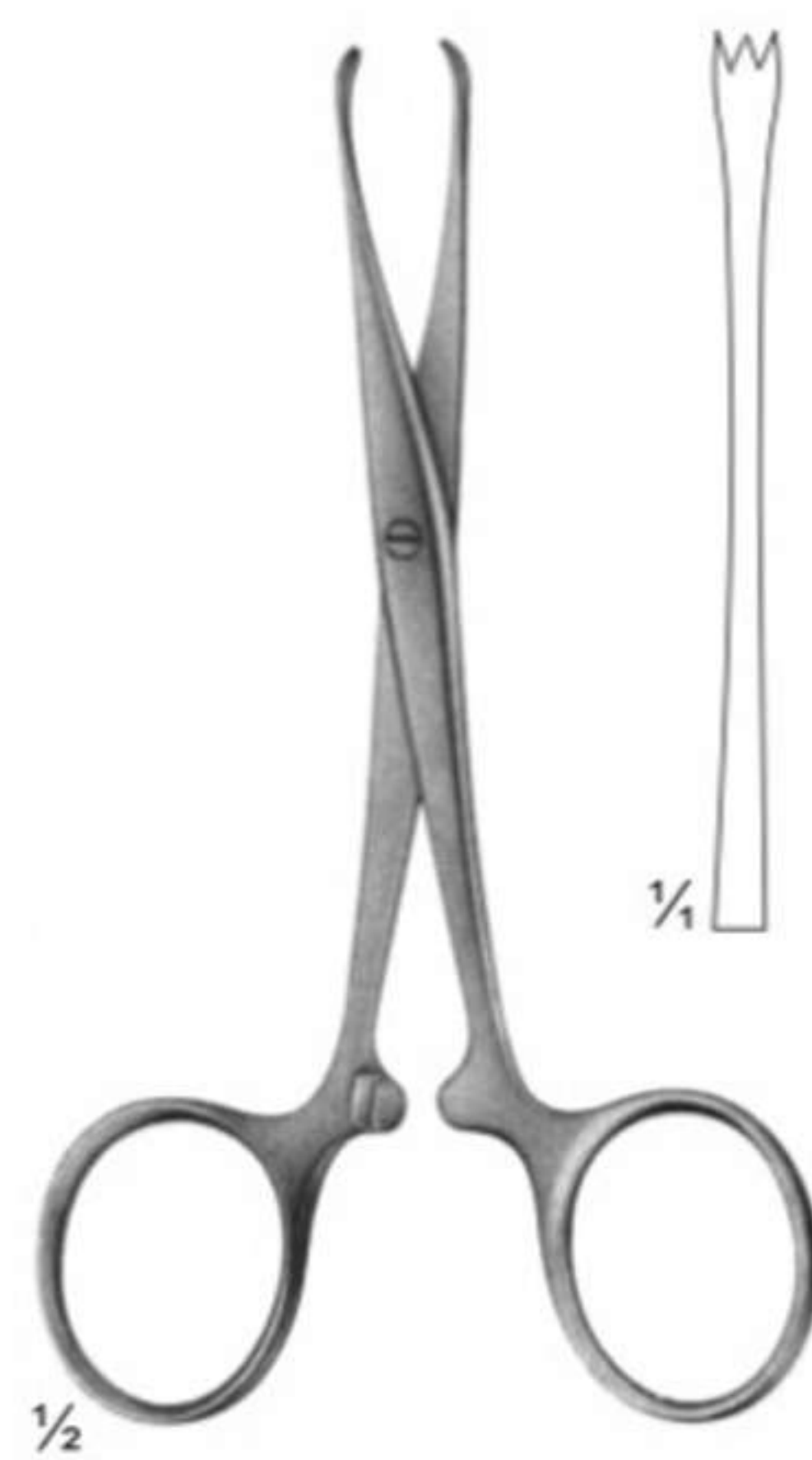

DMI-1-1441
DUVAL 230 mm,

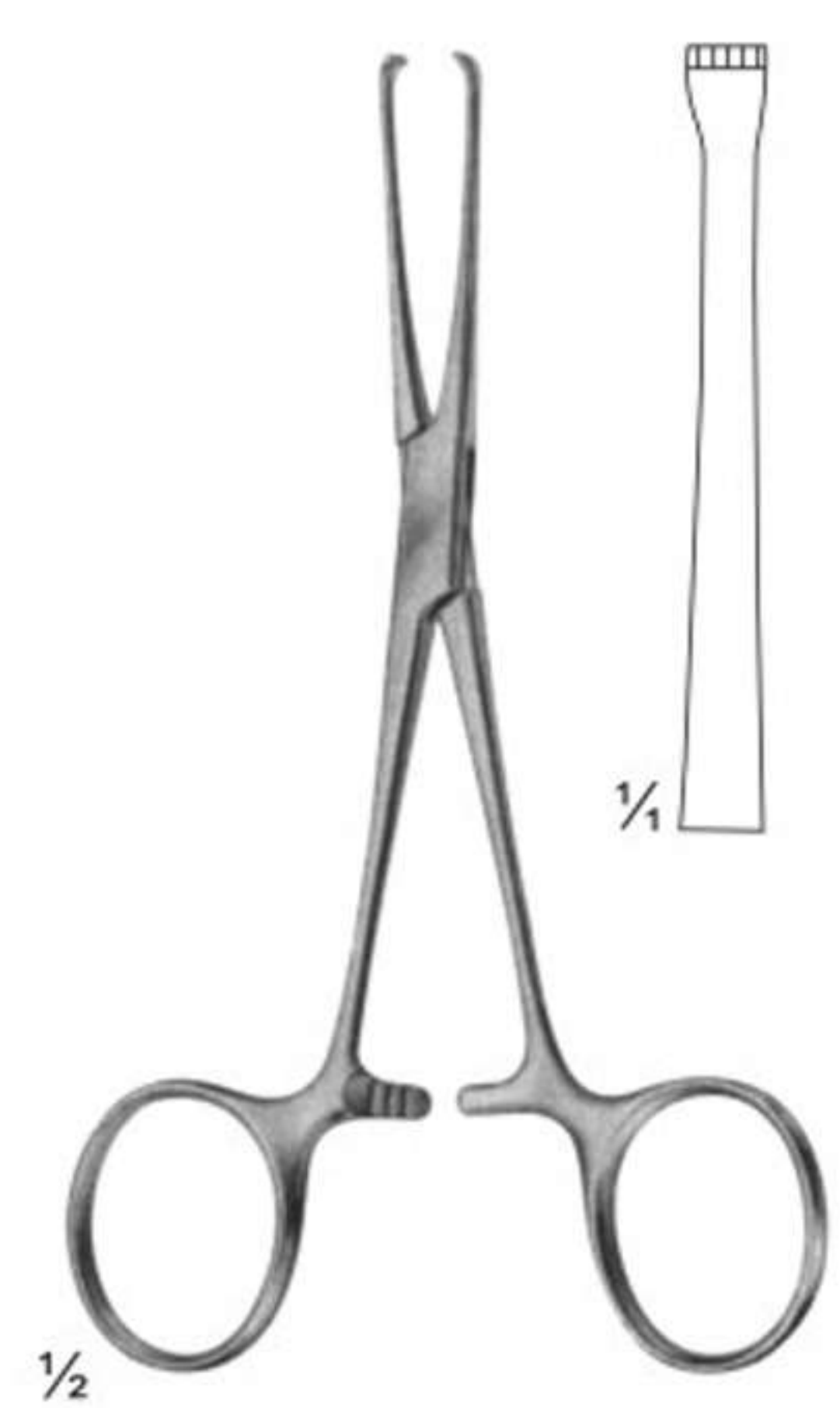

DMI-1-1442
CHAPUT 2 x 3 teeth 125 mm

Sponge, Dressing and Tissue Grasping Forceps

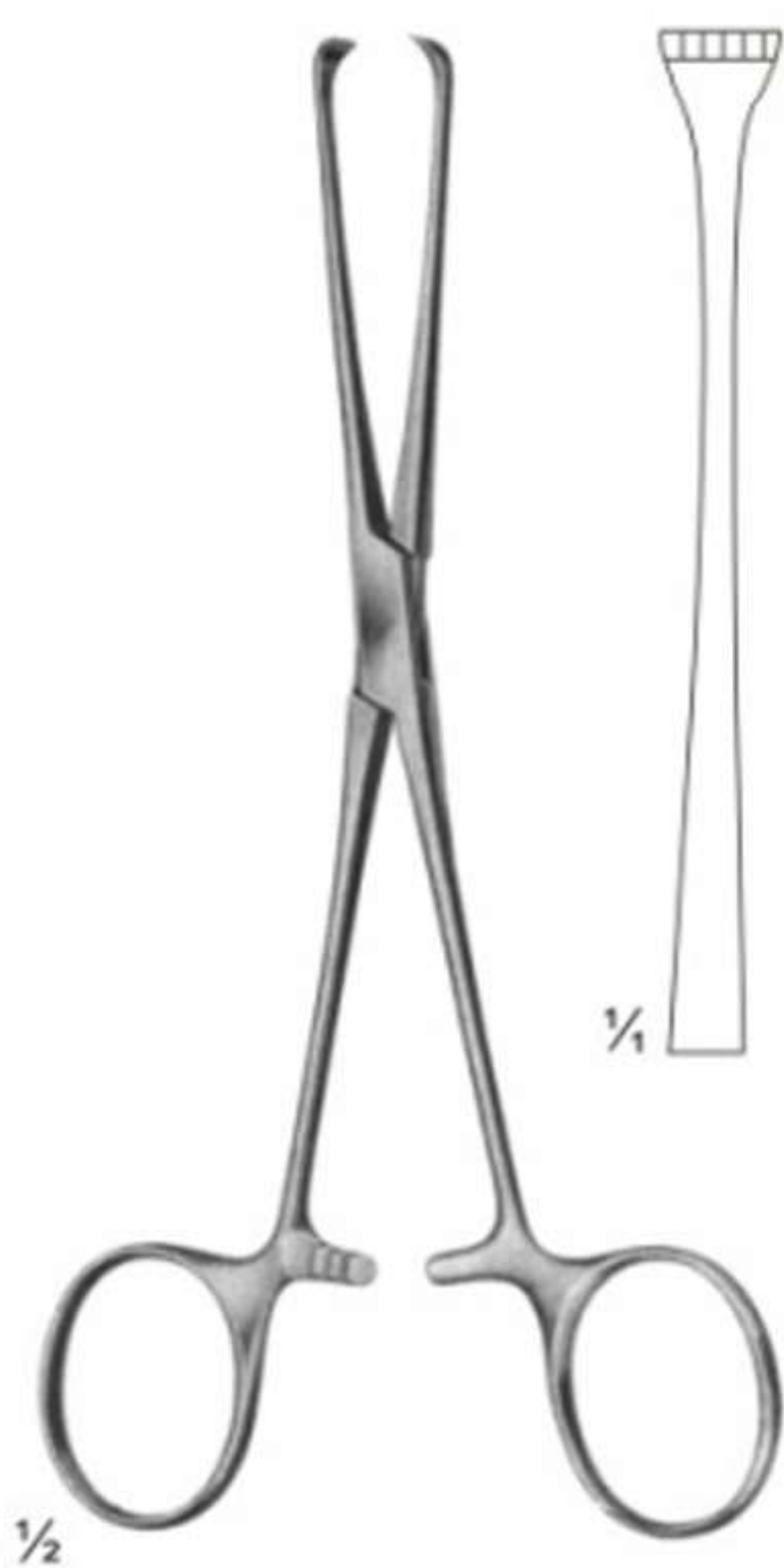

DMI-1-1443
BABY-ALLIS 4 x 5 teeth 130 mm

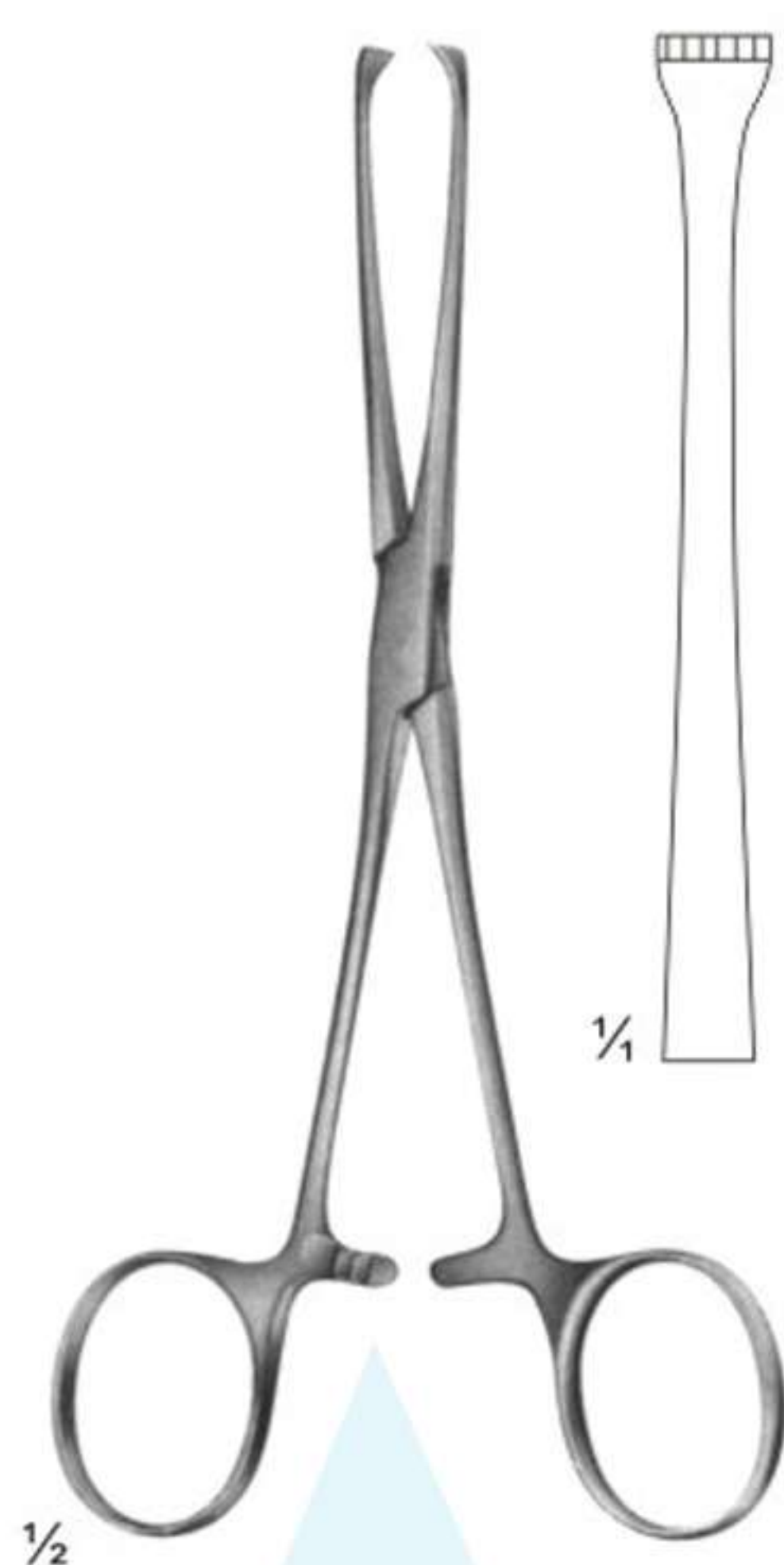

DMI-1-1444
BOYS-ALLIS 5 x 6 teeth sharp 155 mm

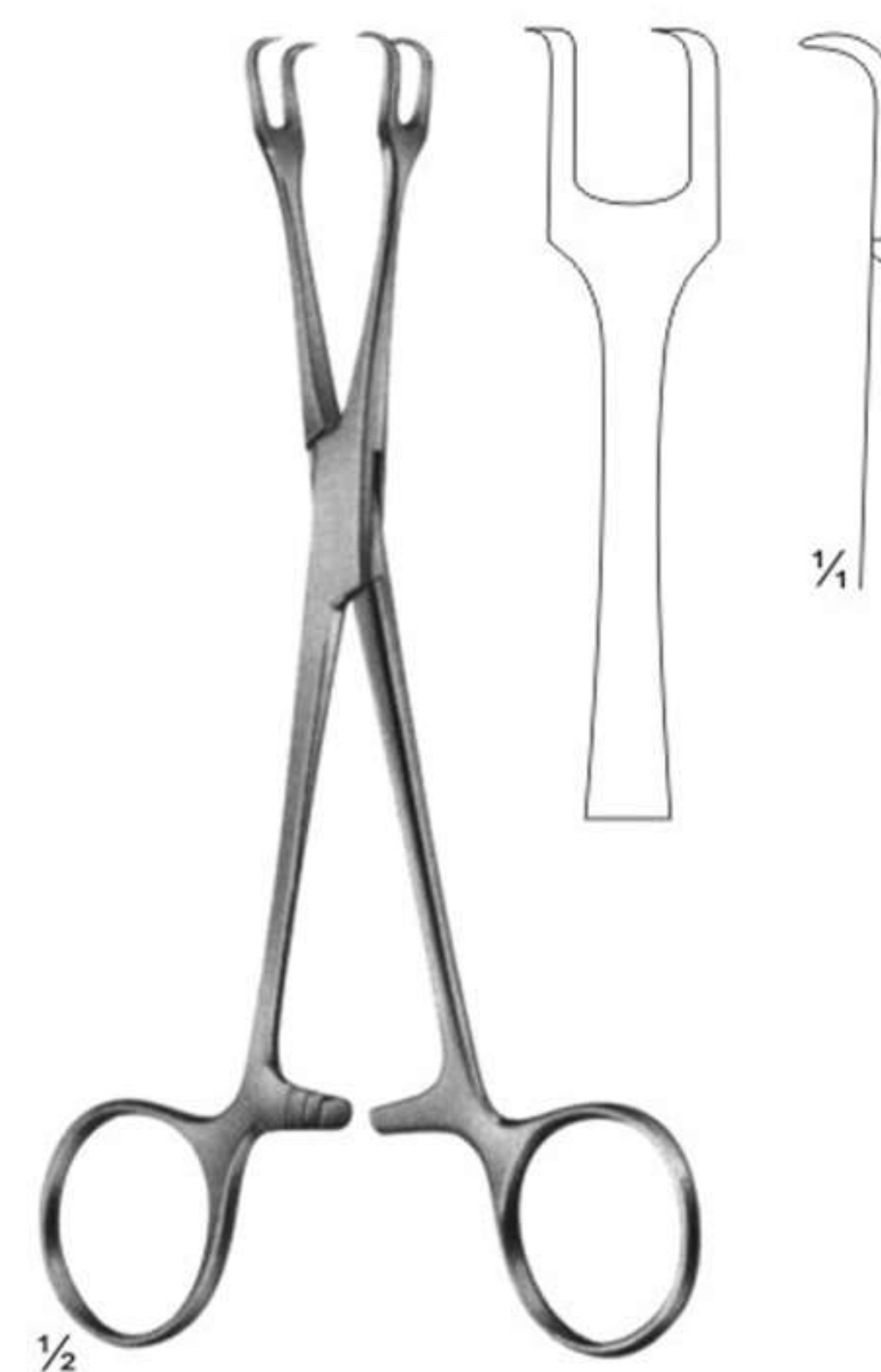

DMI-1-1445
ALLIS 5 x 6 teeth 155 mm

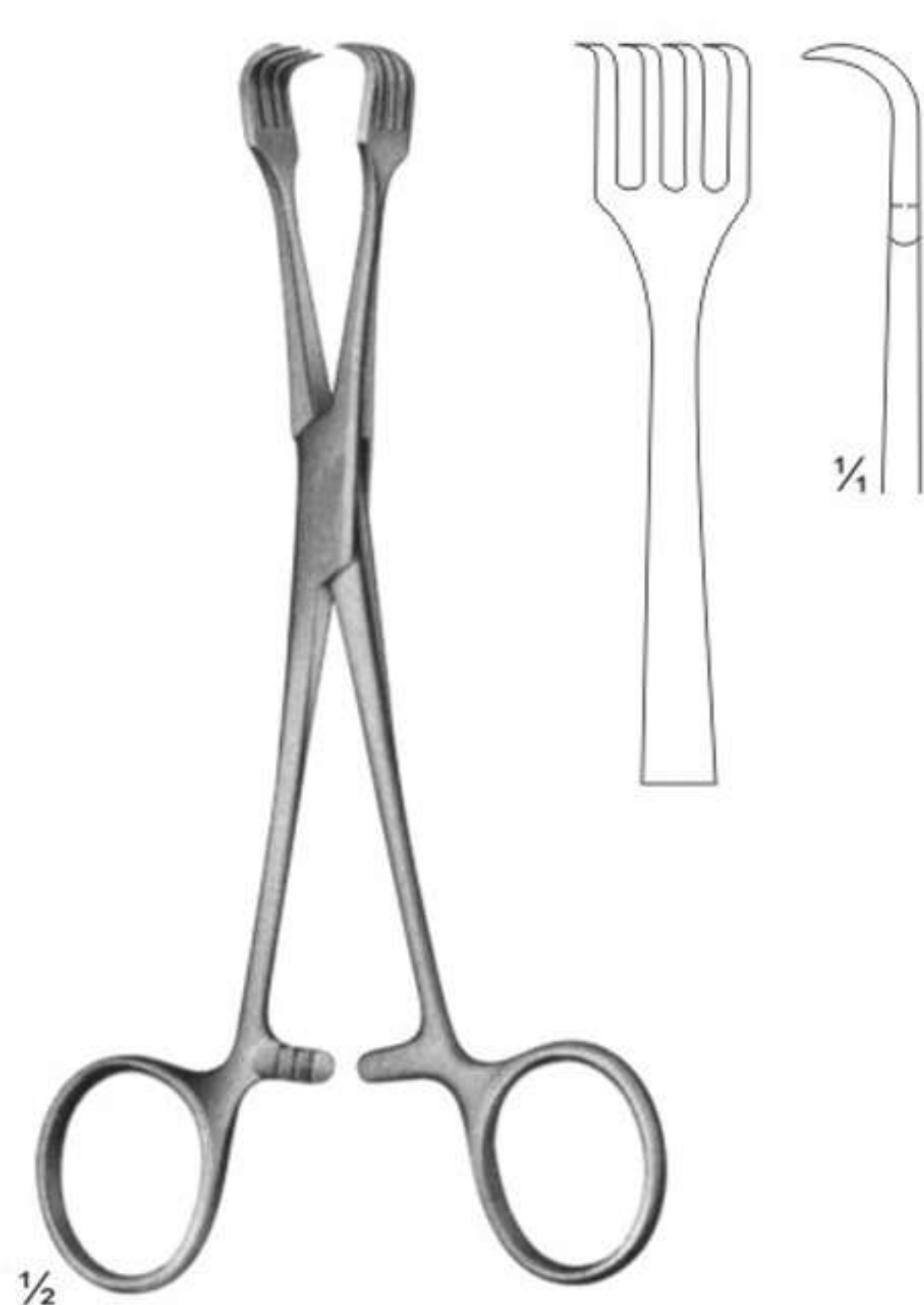

DMI-1-1446
LAHEY 155 mm

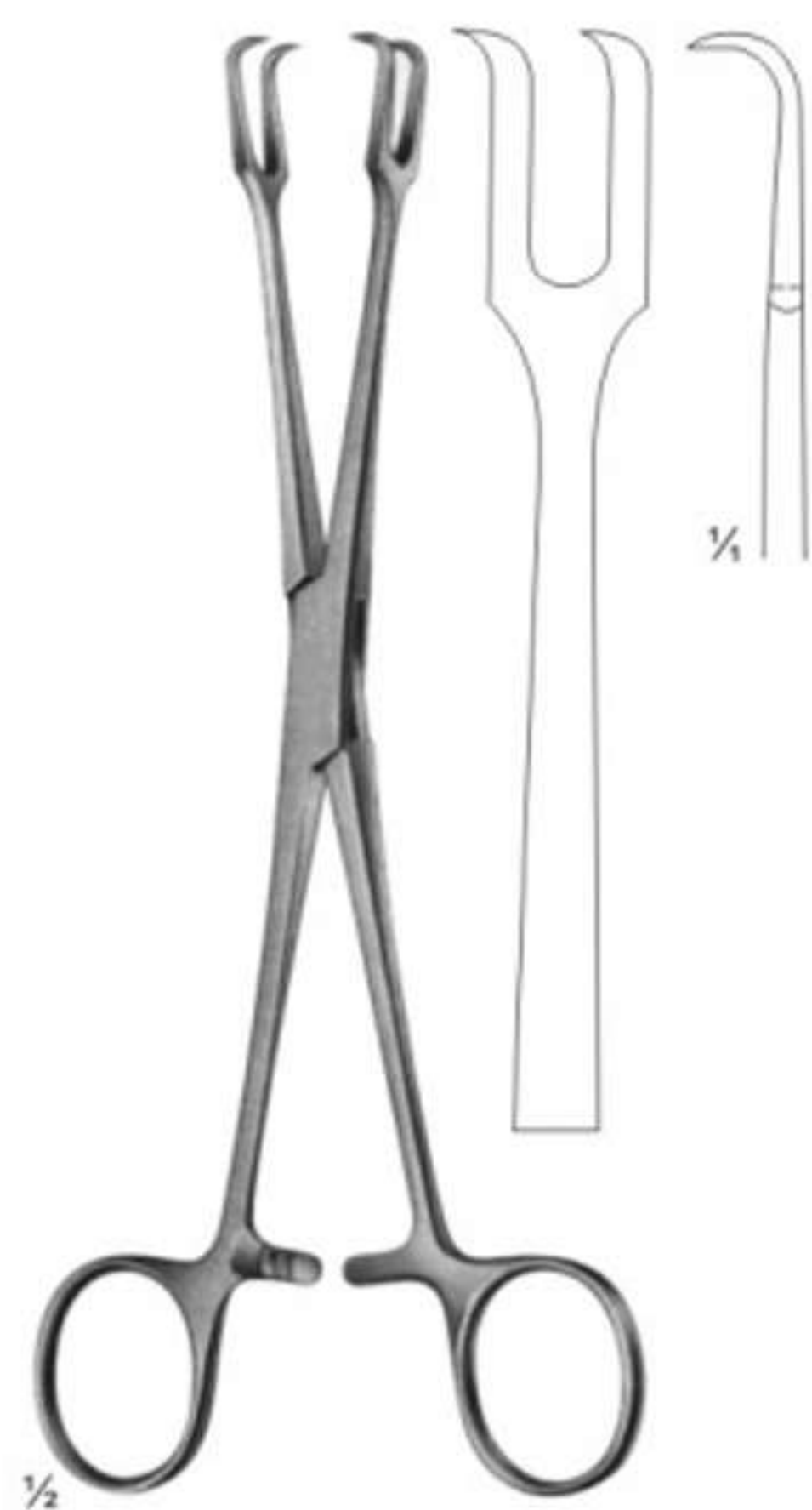

DMI-1-1447
LAHEY 155 mm

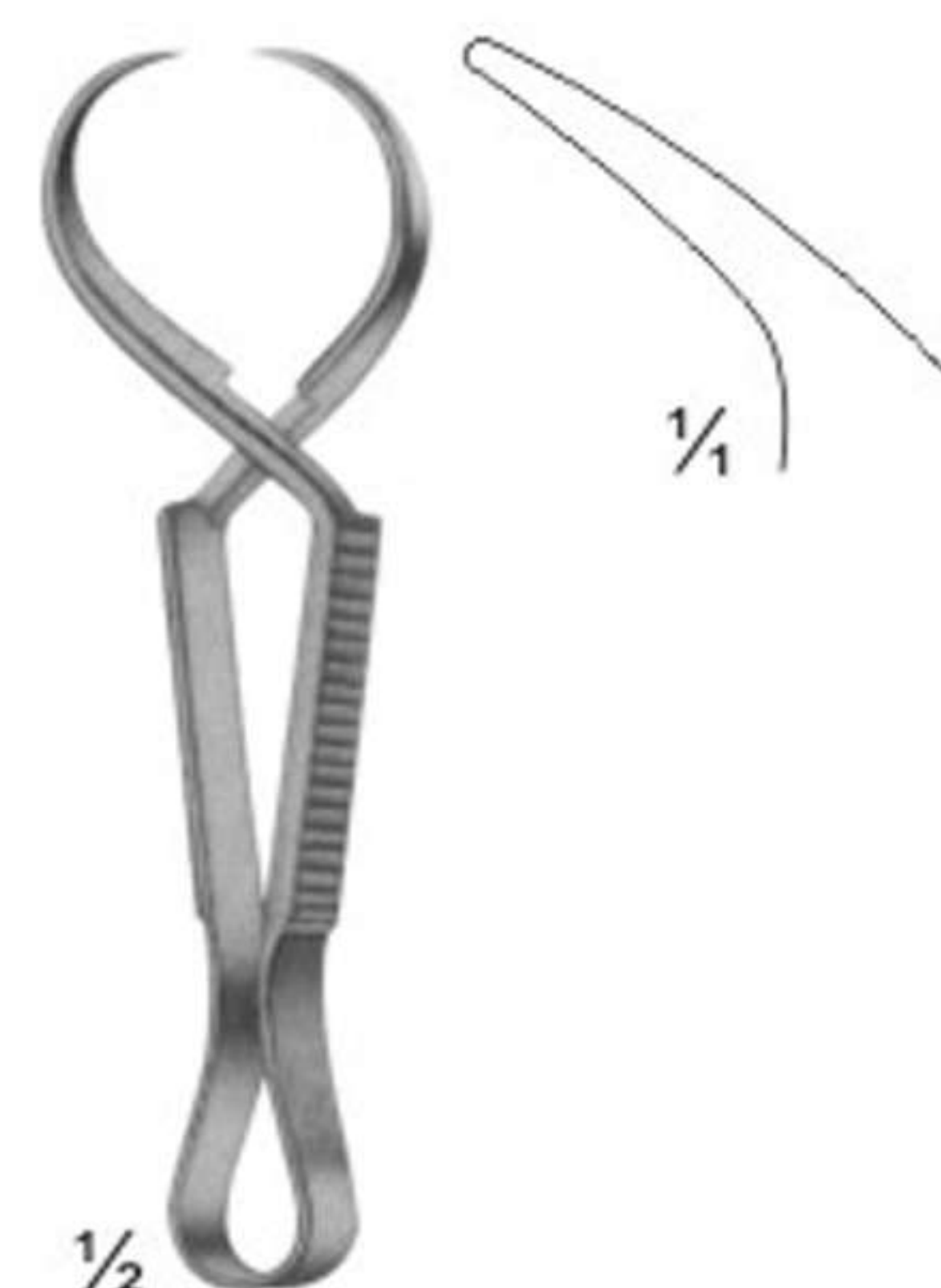

DMI-1-1448
BRAUN 155 mm

Sponge, Dressing and Tissue Grasping Forceps

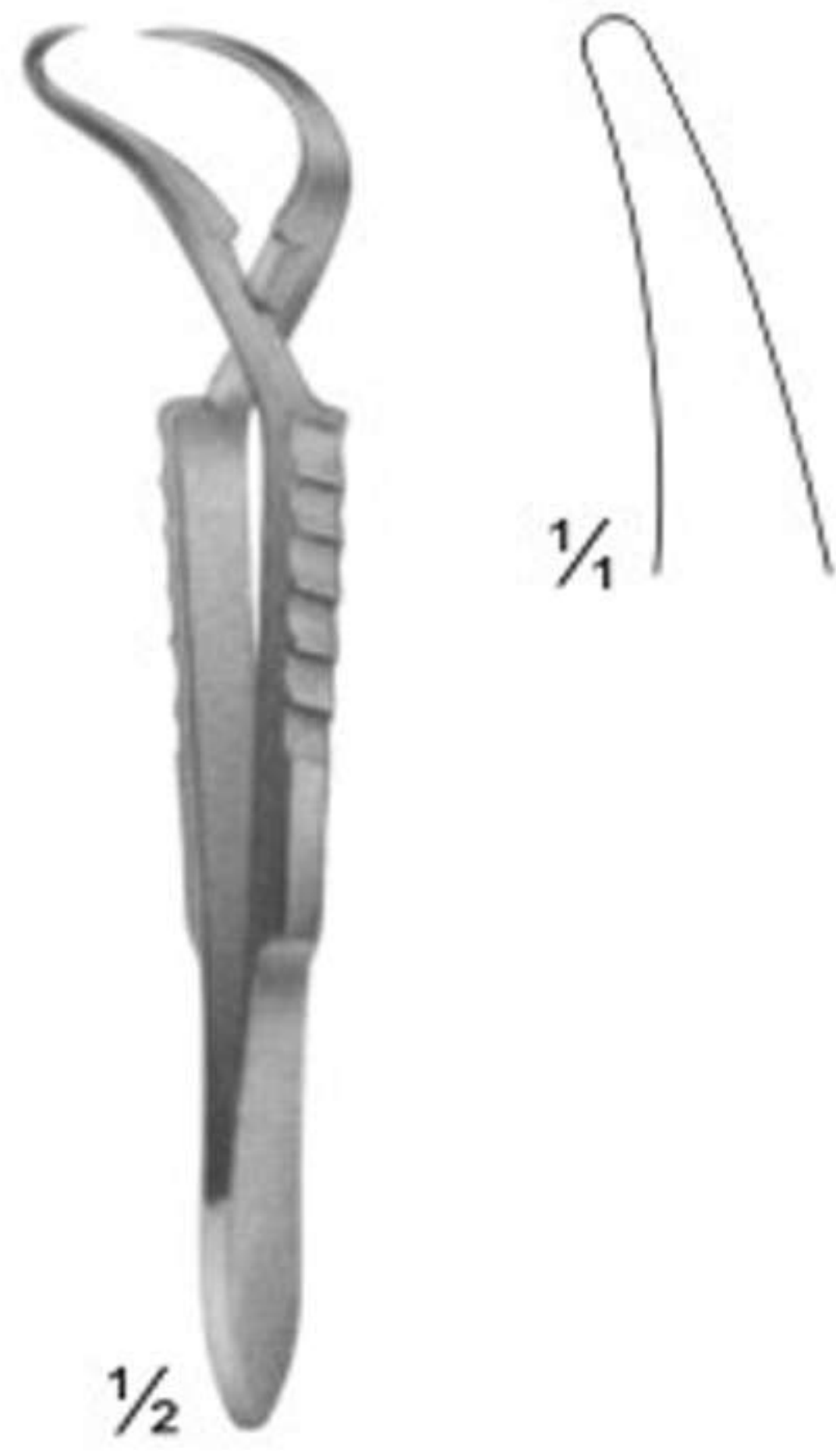

DMI-1-1449
MUSEUX200 mm



DMI-1-1450
JONES85 mm

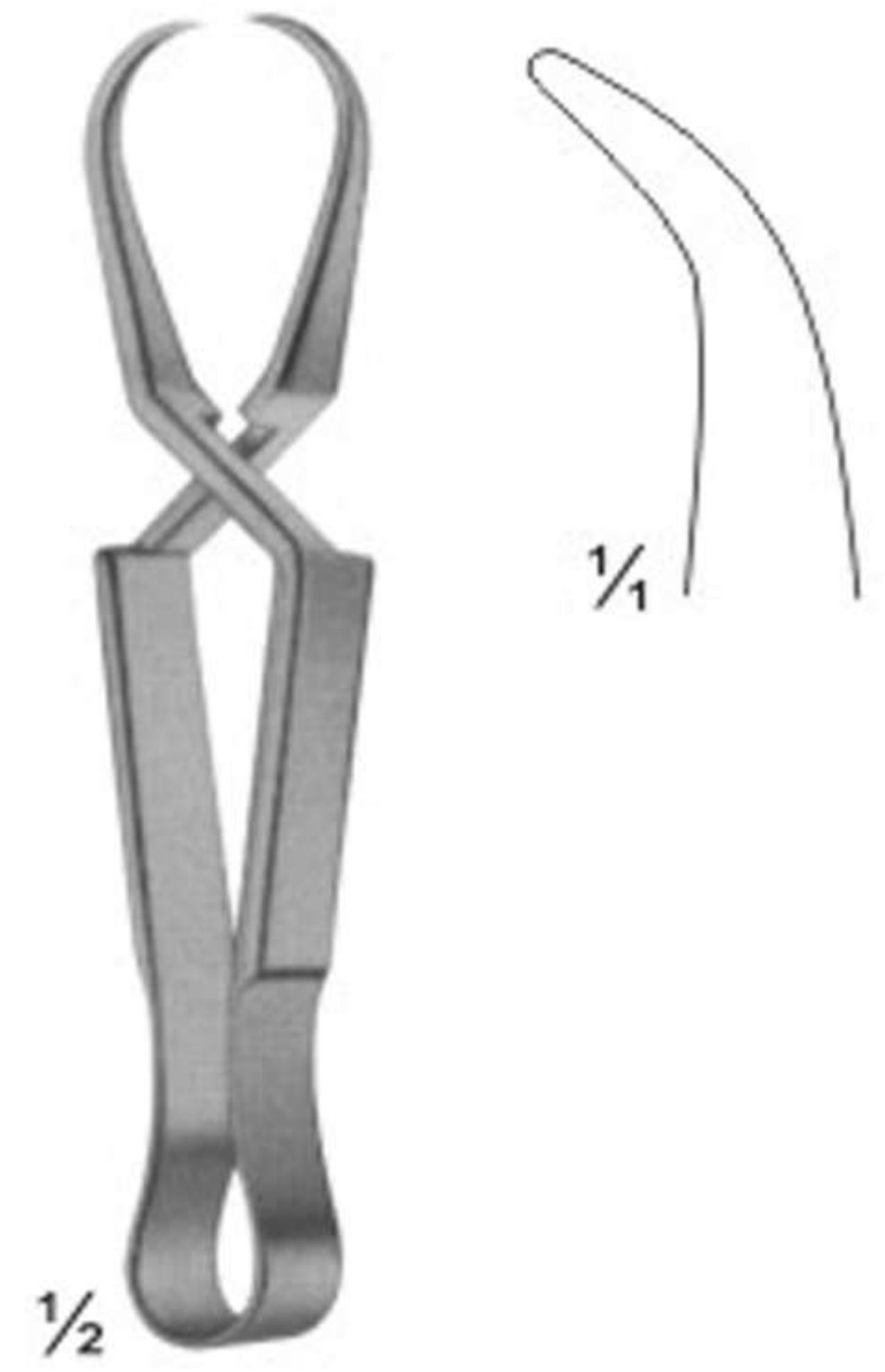

DMI-1-1451
ENGL. MOD.85 mm

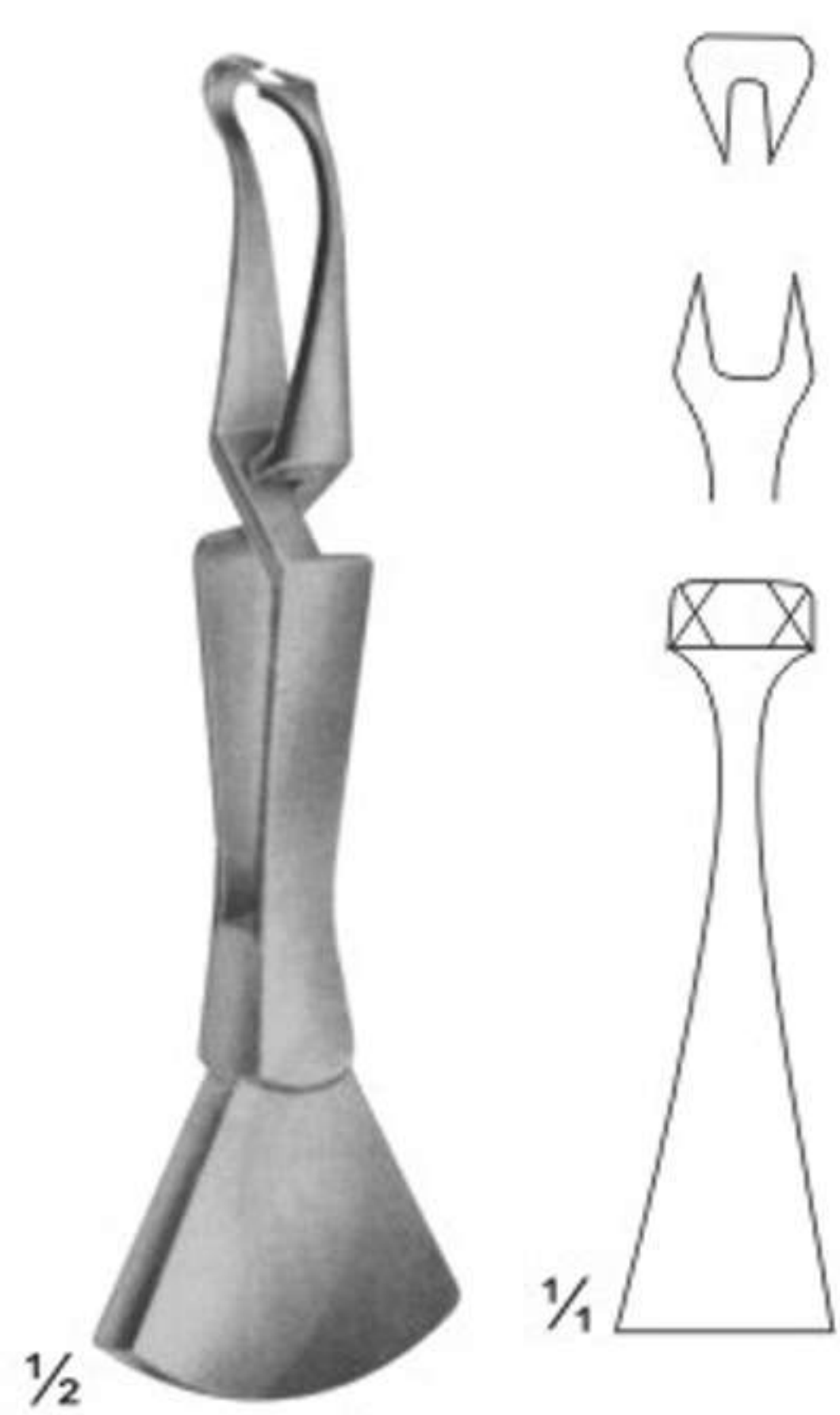

DMI-1-1452
SCHAEDEL85 mm



DMI-1-1453
SCHAEDEL85 mm



DMI-1-1454
DOYEN180 mm

Sponge, Dressing and Tissue Grasping Forceps

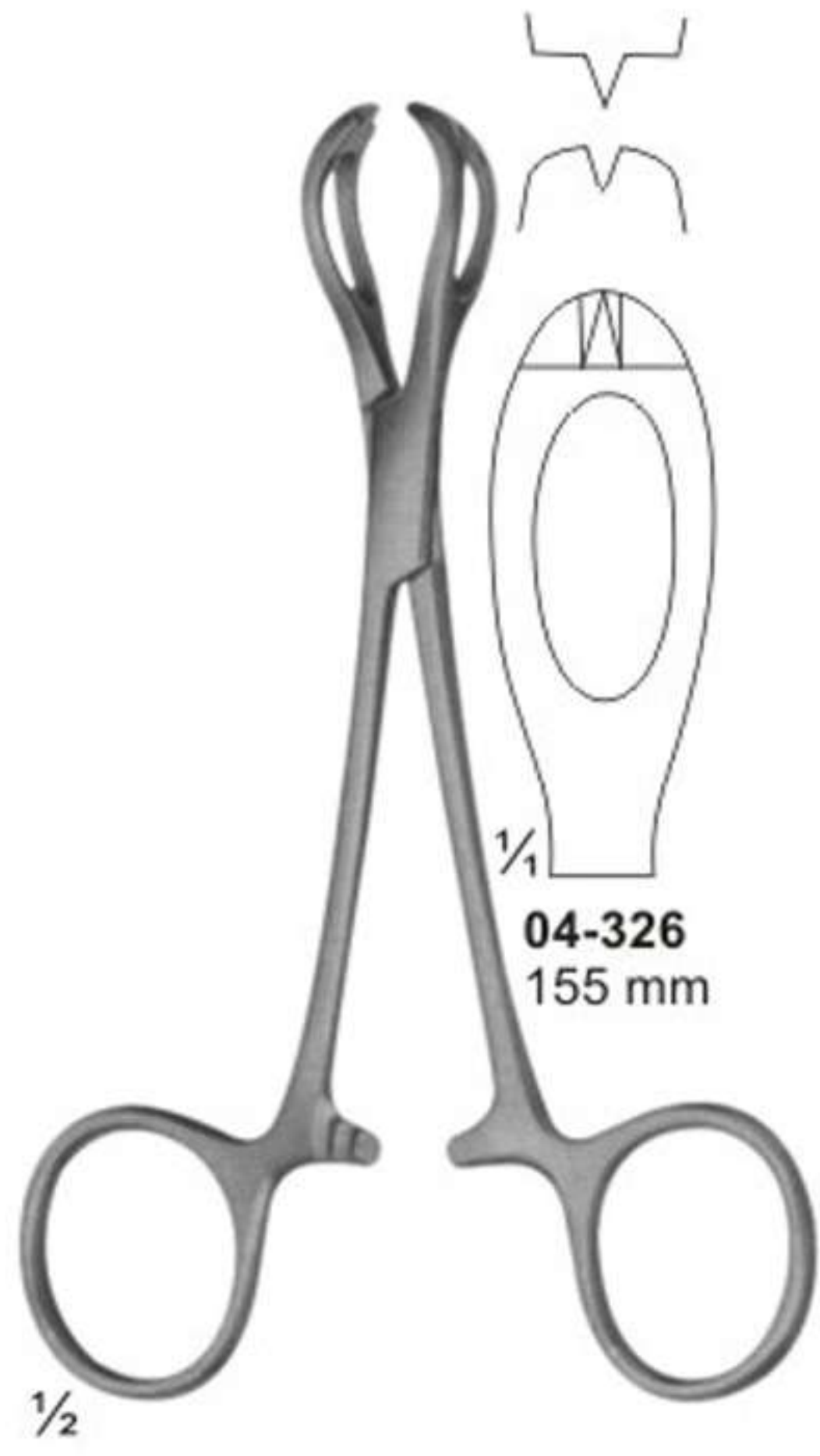

DMI-1-1455
LANE 130 mm

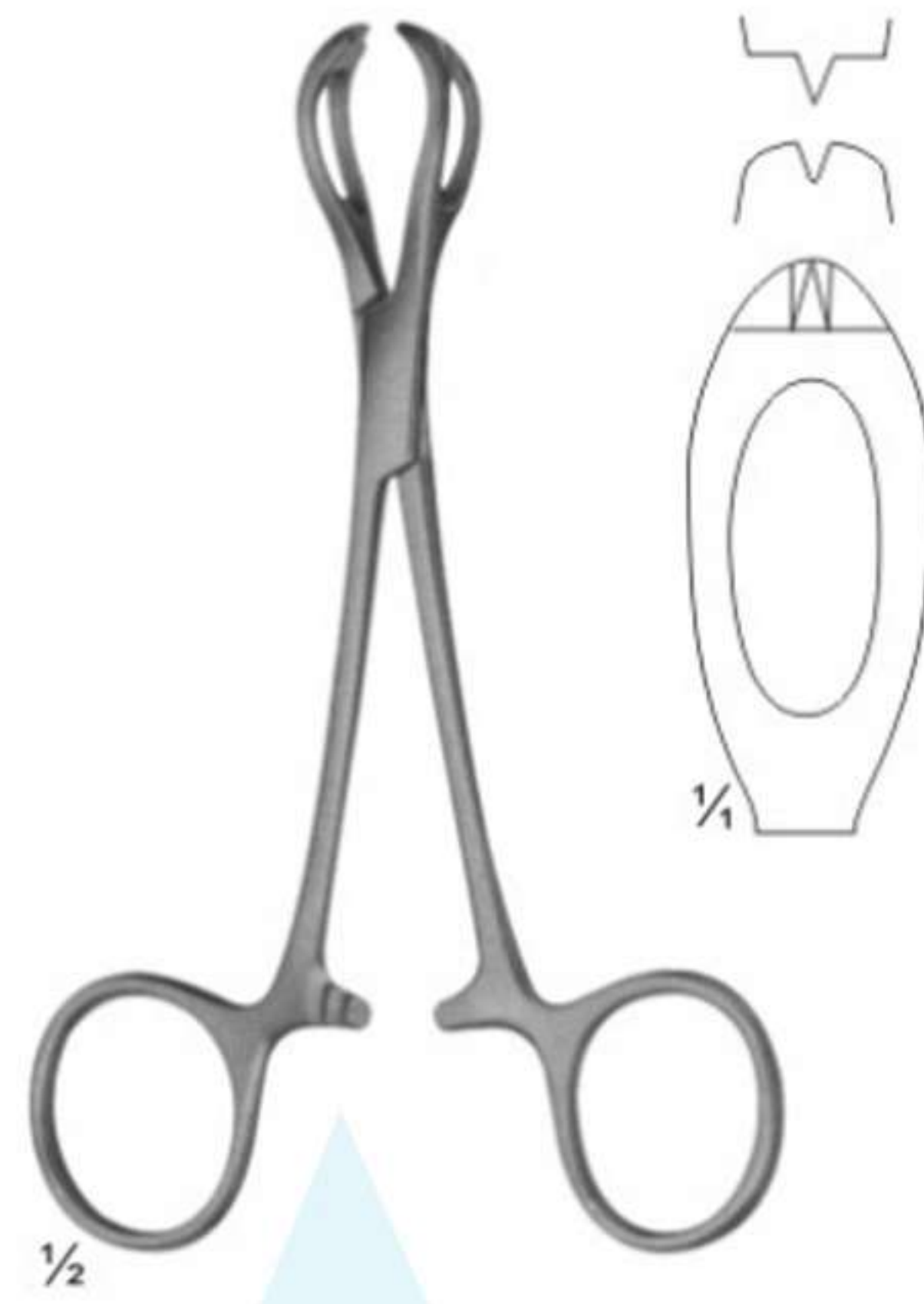

DMI-1-1456
LANE 155 mm

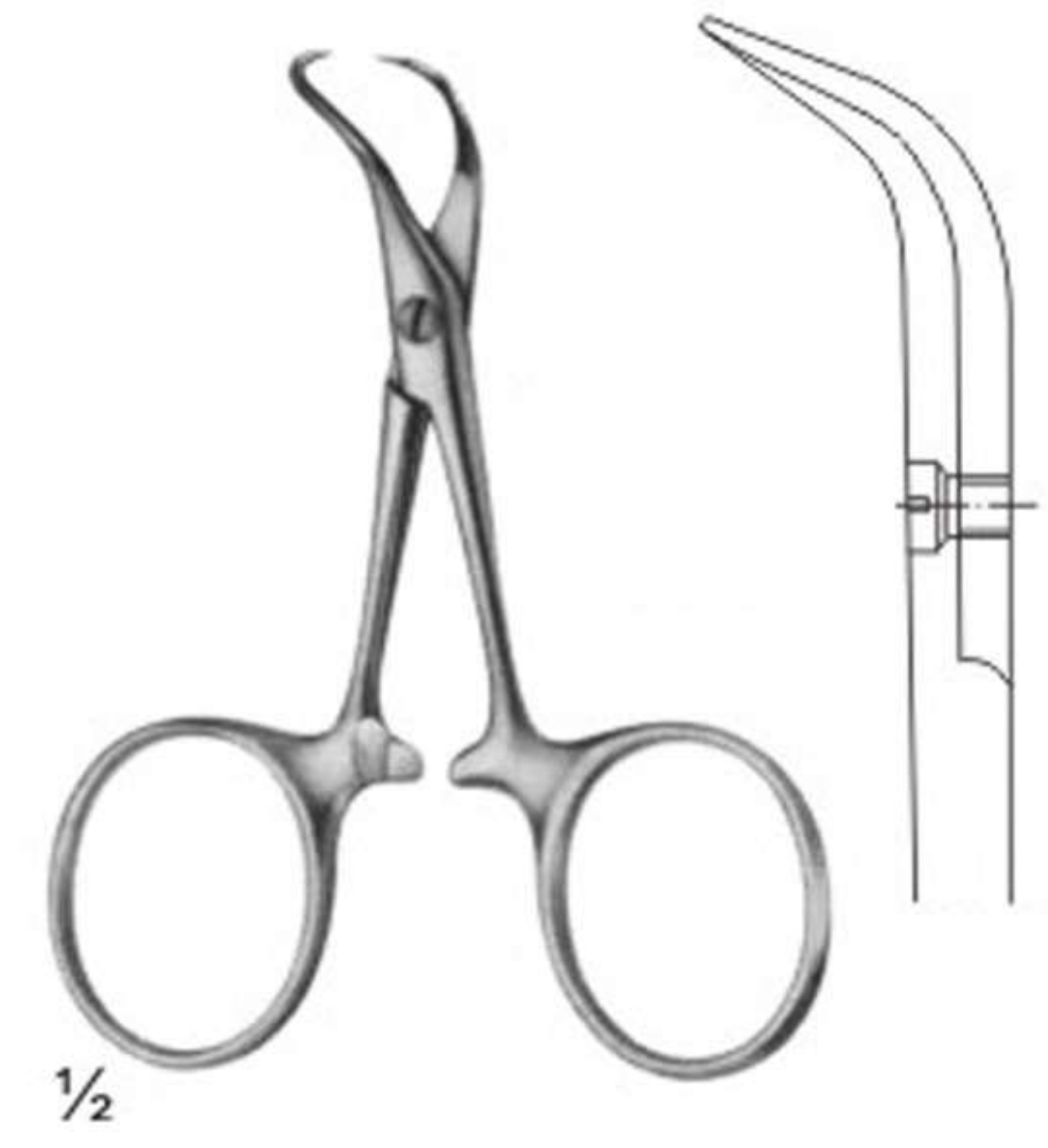

DMI-1-1457
BACKHAUS 80 mm



DMI-1-1458
BACKHAUS 105 mm

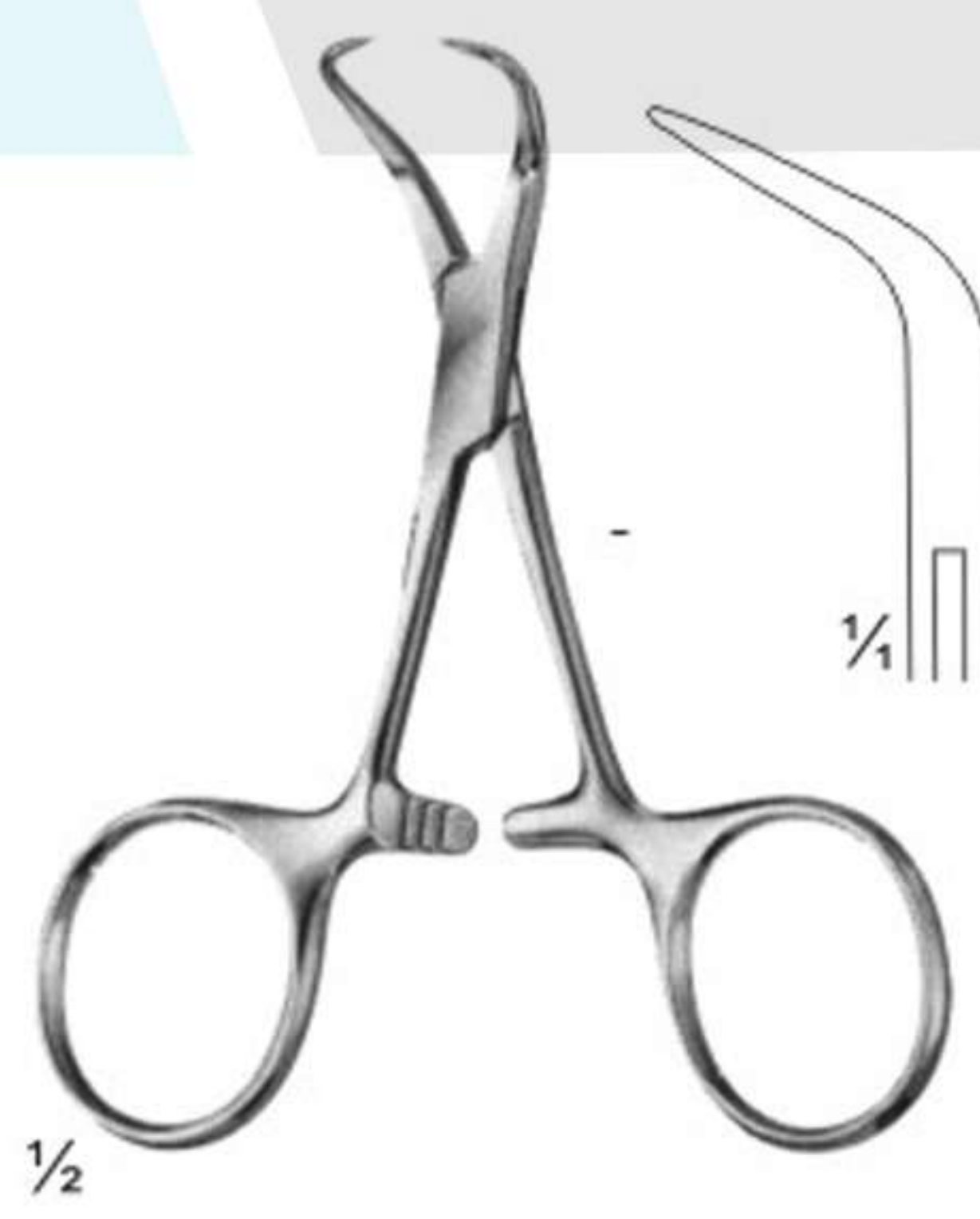

DMI-1-1459
BACKHAUS 90 mm

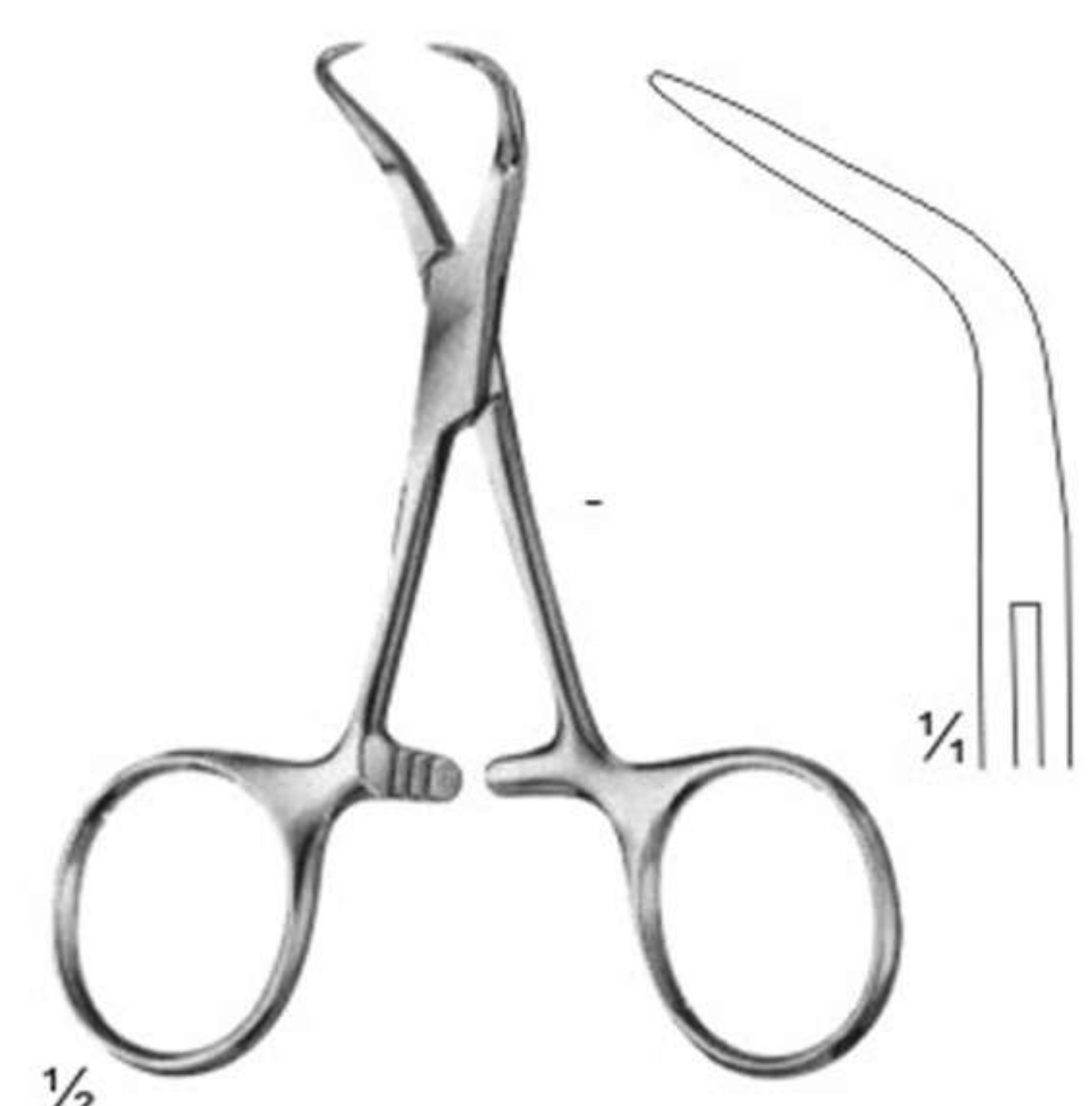

DMI-1-1460
BACKHAUS 110 mm

**Sponge, Dressing and Tissue
Grasping Forceps**



DMI-1-1461
BACKHAUS 135 mm

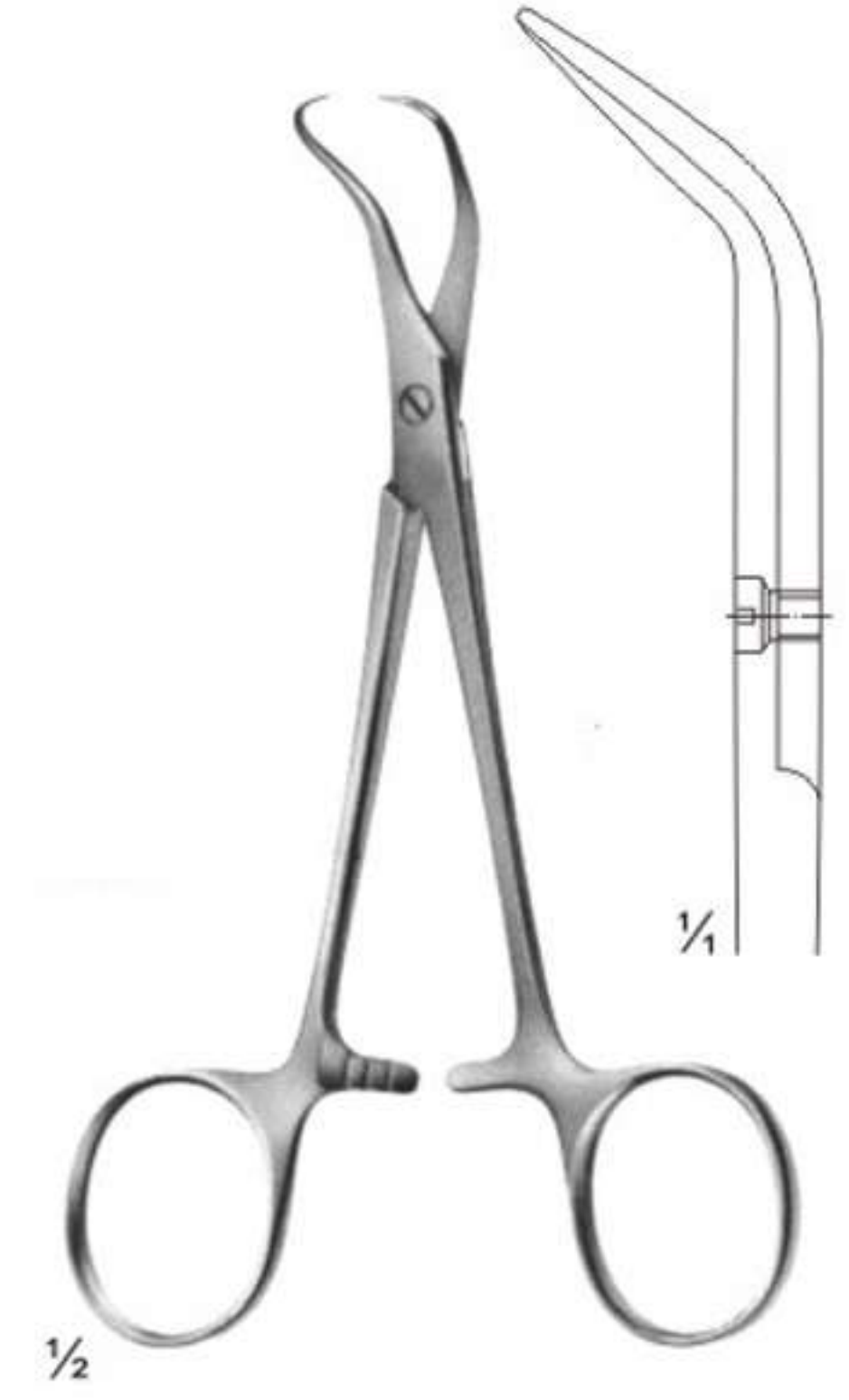

DMI-1-1462
BACKHAUS-KOCHER 135 mm

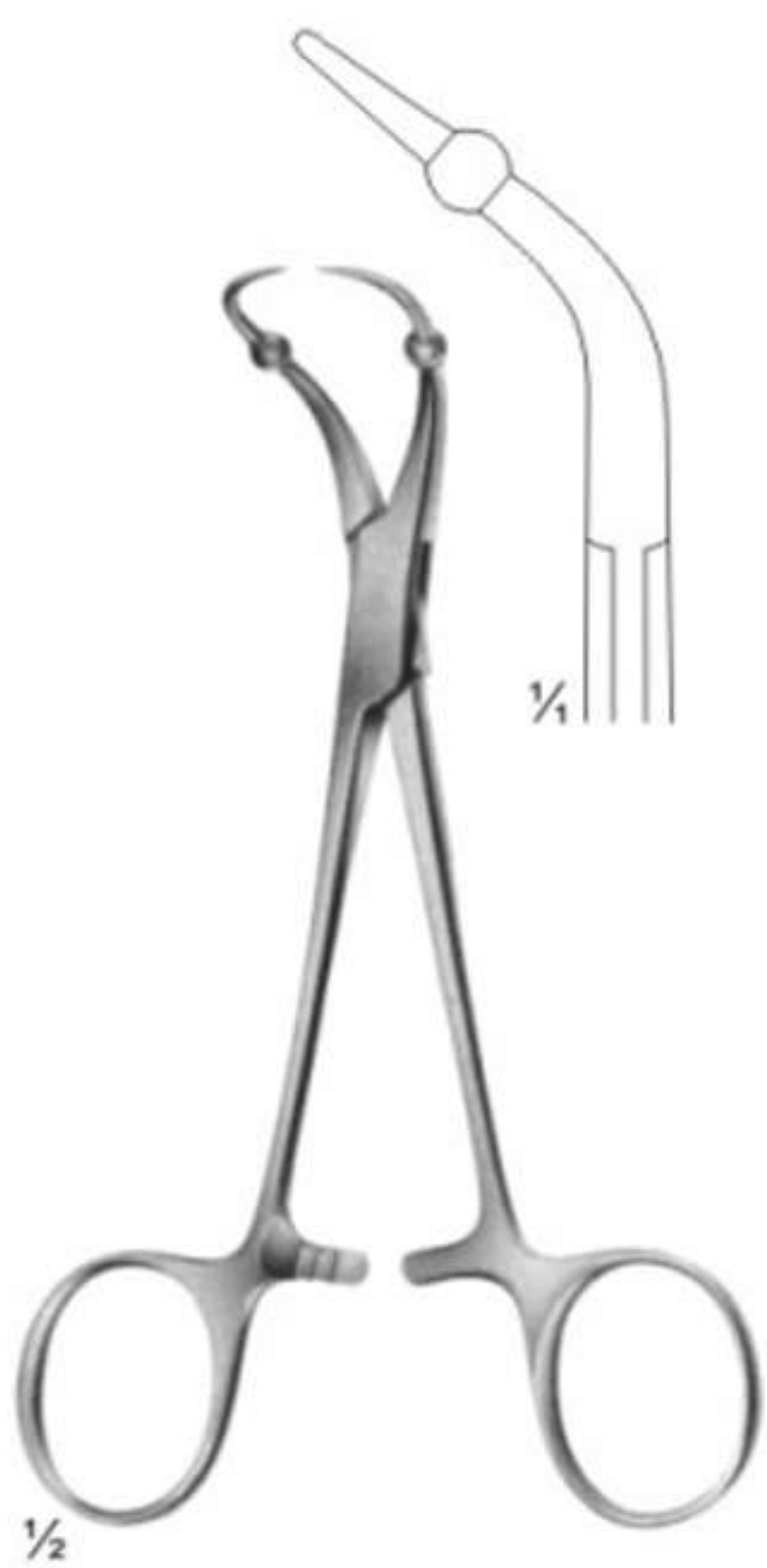

DMI-1-1463
ROEDER 135 mm

**Vessel Clips, Bulldog Clamps
Haemostatic Forceps**



DMI-1-1501
KOCHER-OCHSNER 160 mm



DMI-1-1502
KOCHER-OCHSNER 180 mm



DMI-1-1503
KOCHER-OCHSNER 200 mm

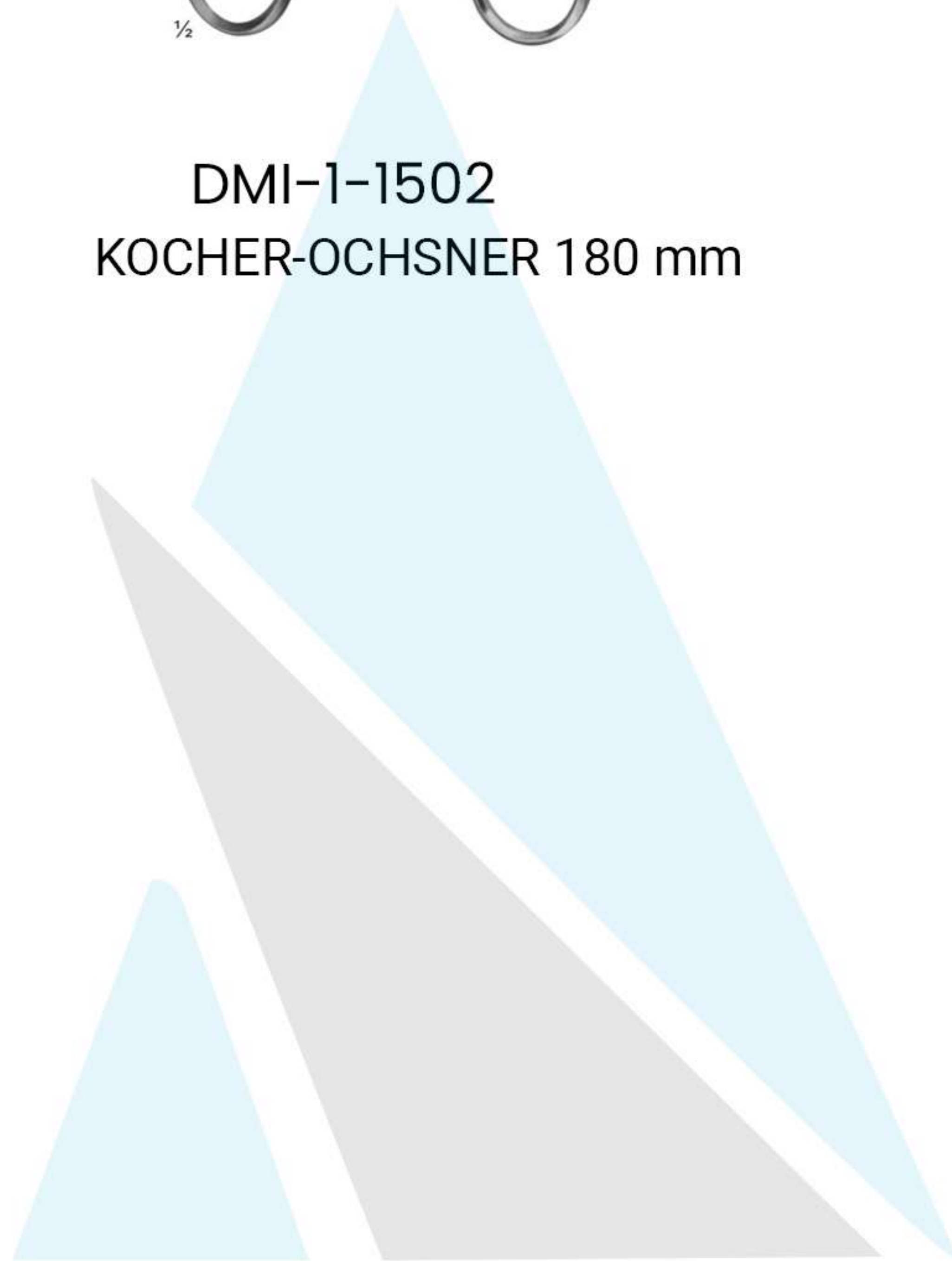

DMI-1-1504
KOCHER-OCHSNER 225 mm



DMI-1-1505
KOCHER-OCHSNER 240



DMI-1-1506
KOCHER-OCHSNER 260 mm

**Vessel Clips, Bulldog Clamps
Haemostatic Forceps**



DMI-1-1507
KOCHER-OCHSNER 160 mm



DMI-1-1508
KOCHER-OCHSNER 185 mm



DMI-1-1509
KOCHER-OCHSNER 200 mm



DMI-1-1510
KOCHER-OCHSNER 225 mm



DMI-1-1511
KOCHER-OCHSNER 240 mm



DMI-1-1512
KOCHER-OCHSNER 260 mm

**Vessel Clips, Bulldog Clamps
Haemostatic Forceps**

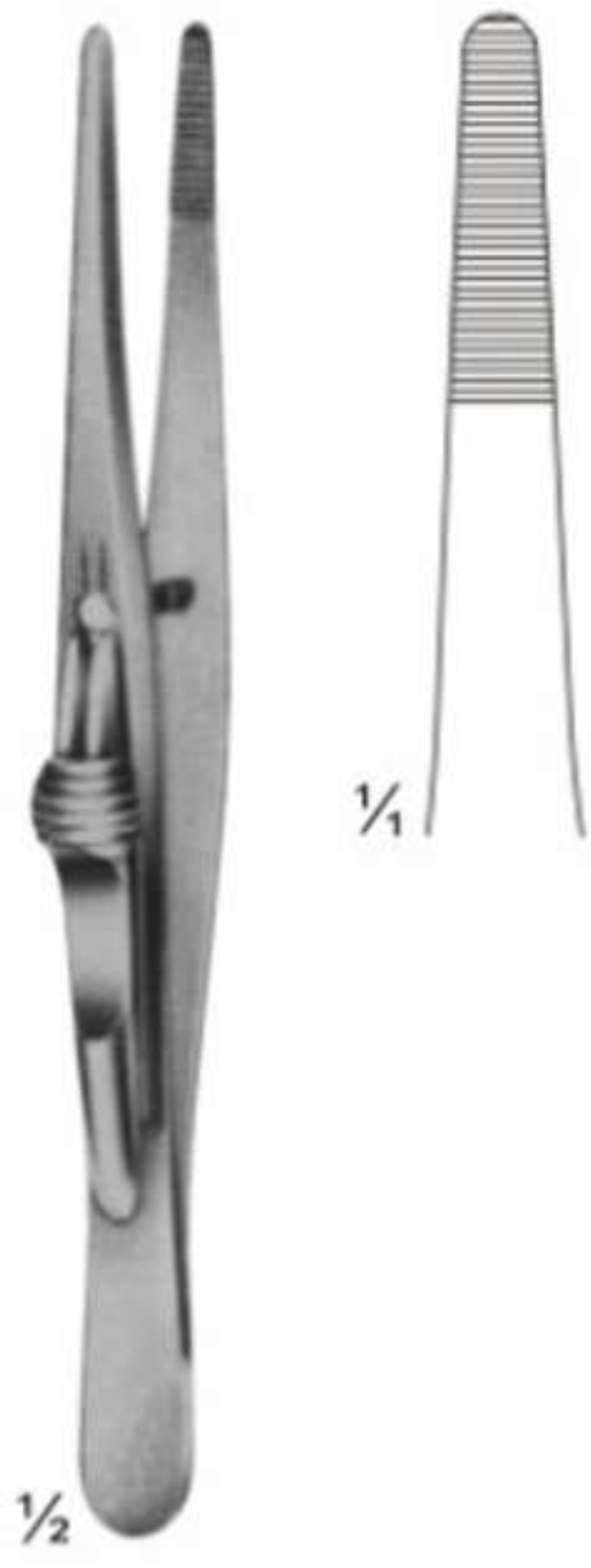

DMI-1-1513
FRICKE Artery forceps 130 mm

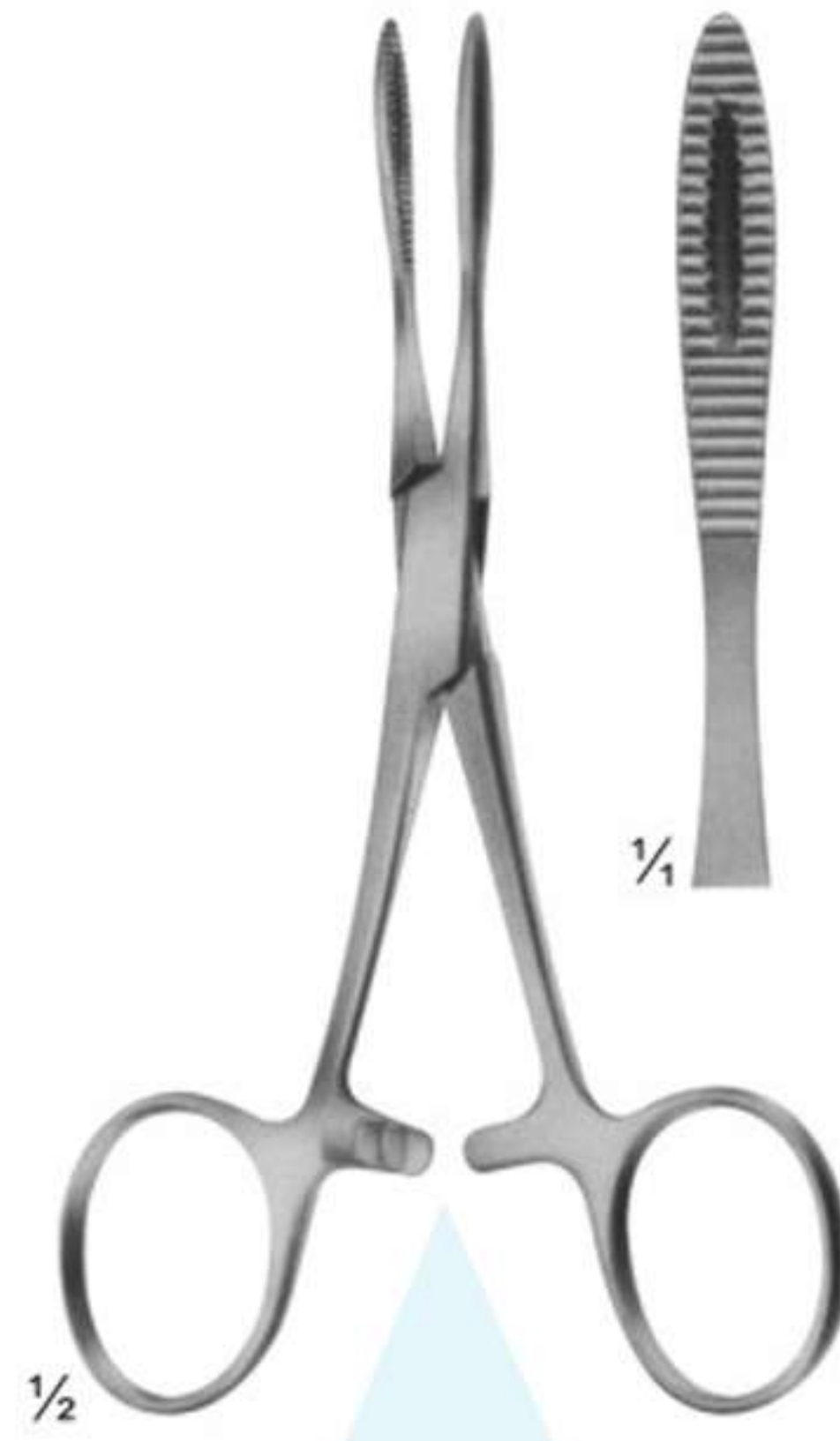

DMI-1-1514
KRONLEIN 130 mm

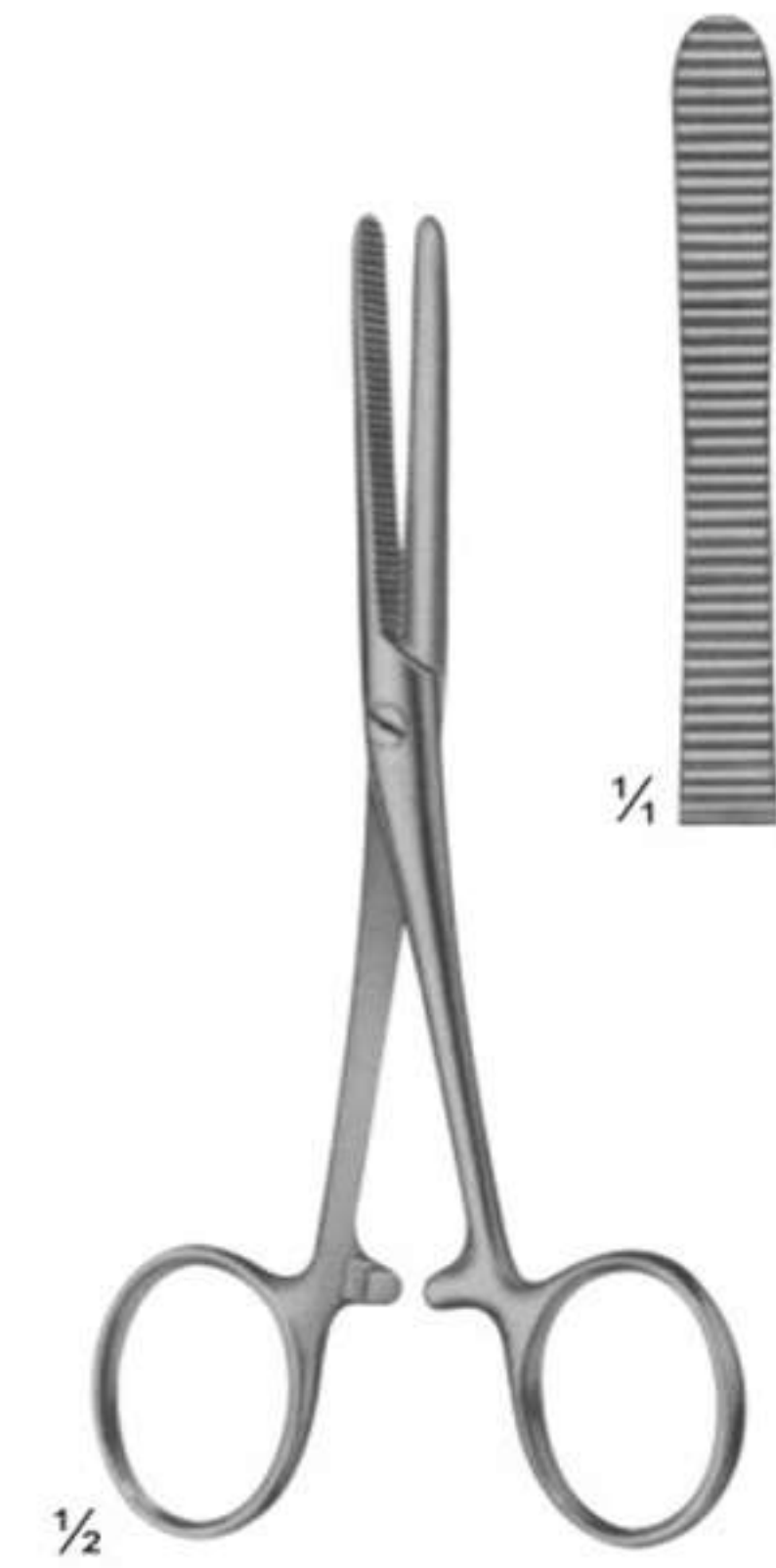

DMI-1-1515
PEAN 125 mm



DMI-1-1516
PEAN 130 mm



DMI-1-1517
PEAN 140 mm



DMI-1-1518
PEAN 125 mm

**Vessel Clips, Bulldog Clamps
Haemostatic Forceps**

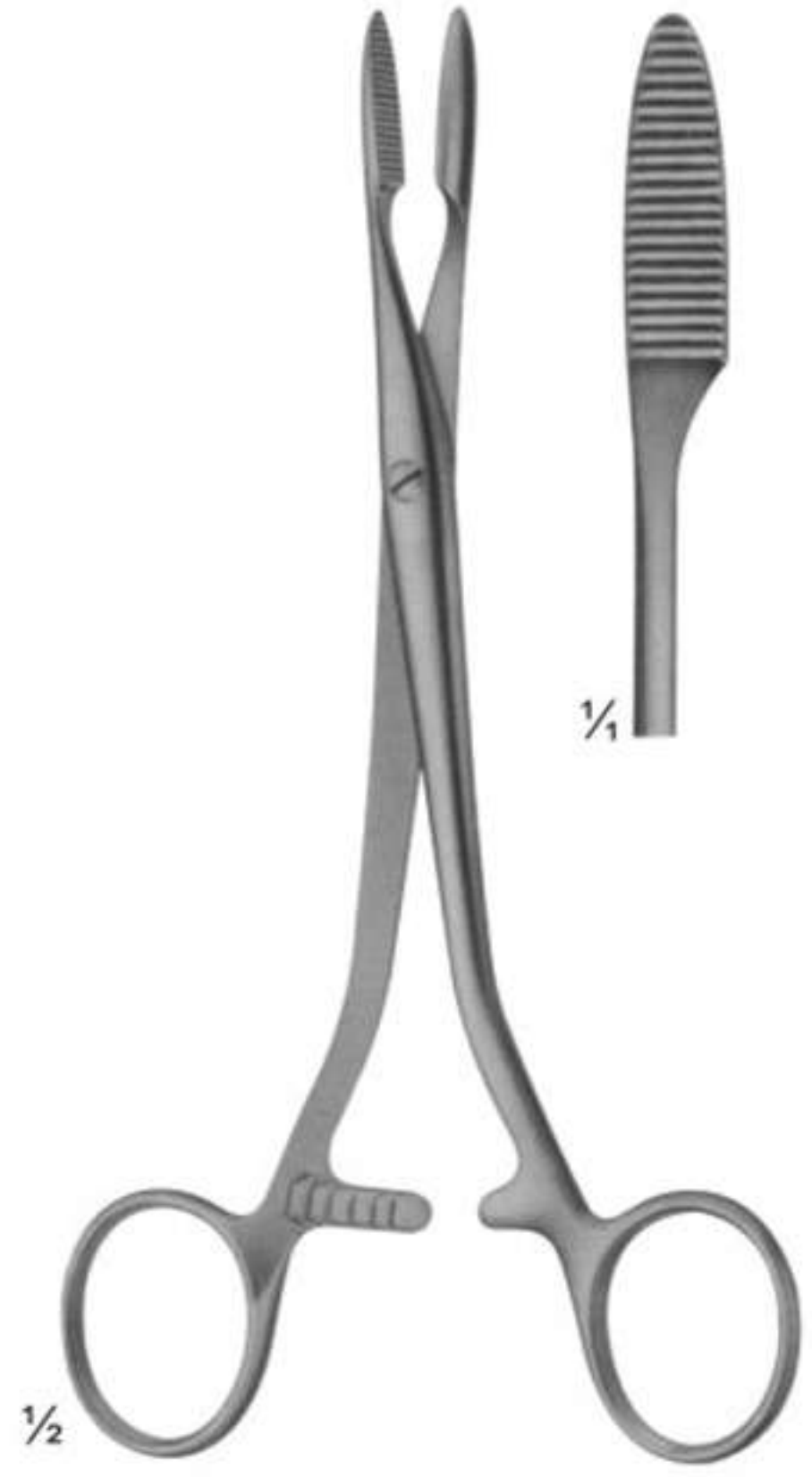

DMI-1-1519
PEAN 165 mm

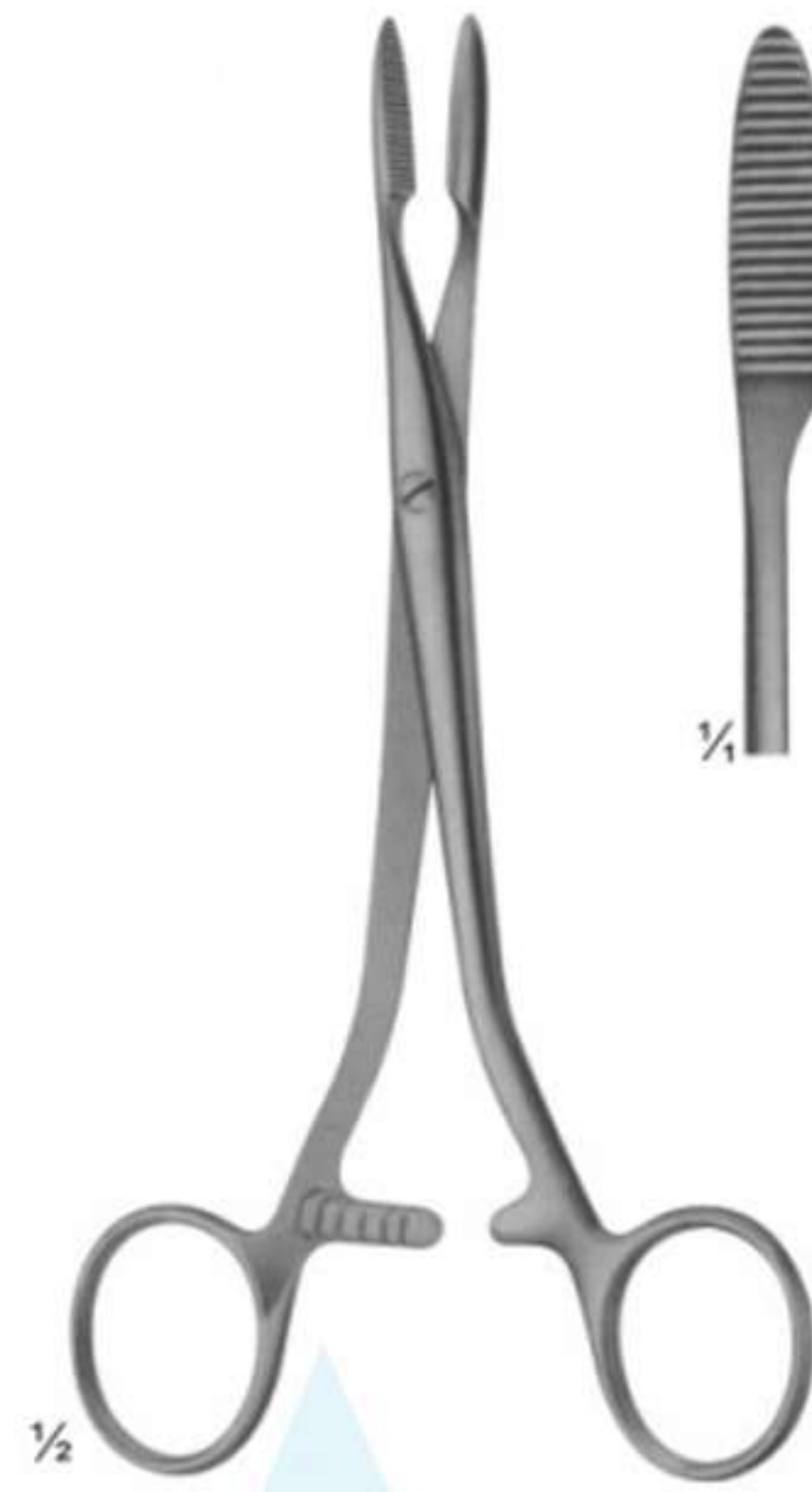

DMI-1-1520
PEAN 185 mm



DMI-1-1521
ROCHESTER-CARMALT 160 mm

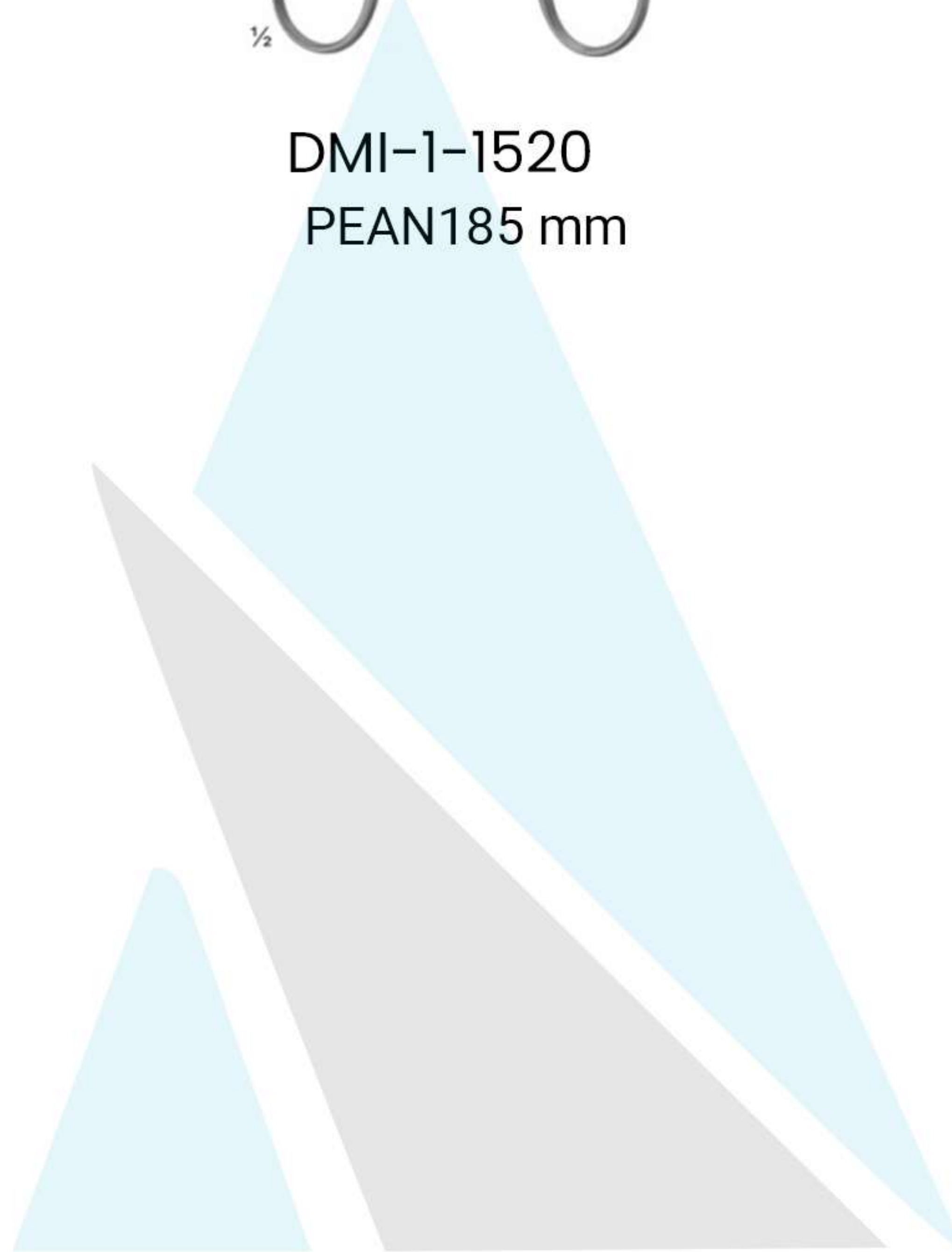

DMI-1-1522
ROCHESTER-CARMALT 200 mm



DMI-1-1523
ROCHESTER-CARMALT 160 mm



DMI-1-1524
ROCHESTER-CARMALT 200 mm

**Vessel Clips, Bulldog Clamps
Haemostatic Forceps**



DMI-1-1525
MOYNIHAN 230 mm



DMI-1-1526
MOYNIHAN 240 mm



DMI-1-1527
ROCHESTER-CARMALT 160 mm



DMI-1-1528
PEAN 220 mm



DMI-1-1529
NEGUS 190 mm



DMI-1-1530
NEGUS 190 mm

**Vessel Clips, Bulldog Clamps
Haemostatic Forceps**



DMI-1-1531
NEGUS 190 mm



DMI-1-1532
MIKULICZ 185 mm



DMI-1-1533
straight 80g 50g



DMI-1-1534
Curved 80g 50g



DMI-1-1535
curved tips 80g 50g

**Vessel Clips, Bulldog Clamps
Haemostatic Forceps**



DMI-1-1536
NEGUS 190 mm



DMI-1-1537
MIKULICZ 185 mm



DMI-1-1538
straight 80g 50g



DMI-1-1539
Curved 80g 50g



DMI-1-1540
curved tips 80g 50g



DMI-1-1541
angled shaped 80g 50g

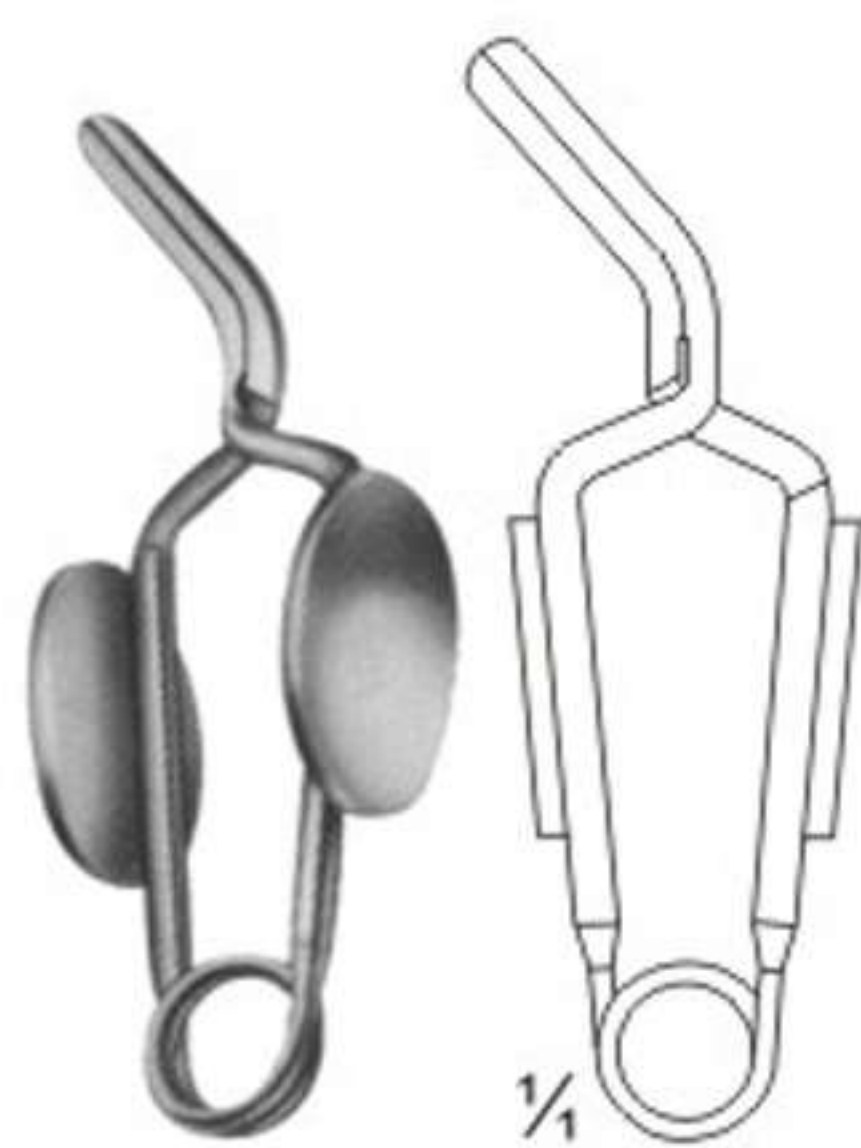

DMI-1-1542
MULLER knee-bent 80g 50g



DMI-1-1543
Muller Ligature Forceps Jaw,
cross serrated

**Ligature, Hysterectomy and
Compression Forceps Vaginal Clamps**

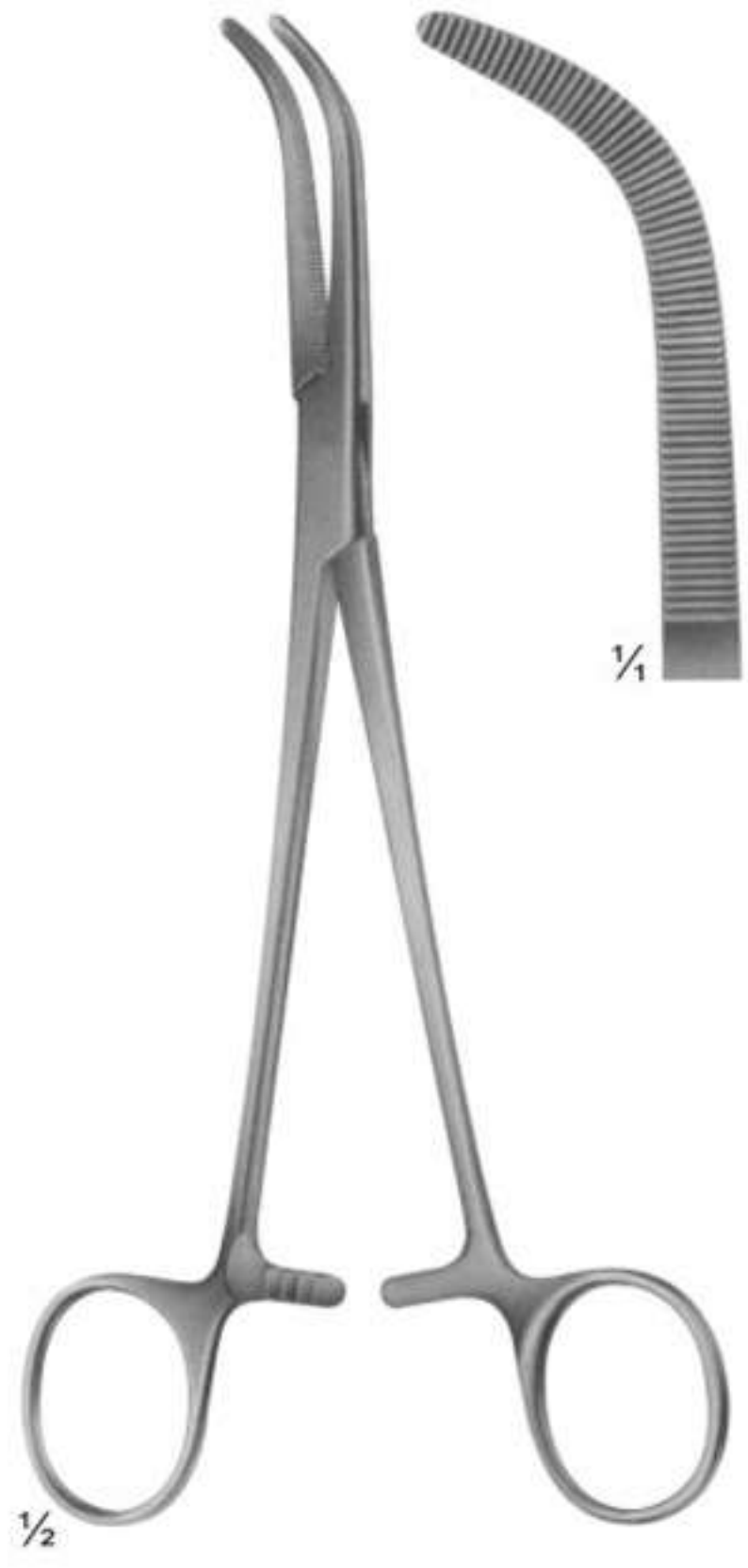

DMI-1-1601
MIXTER-O'SHAUGNESSY 190 mm

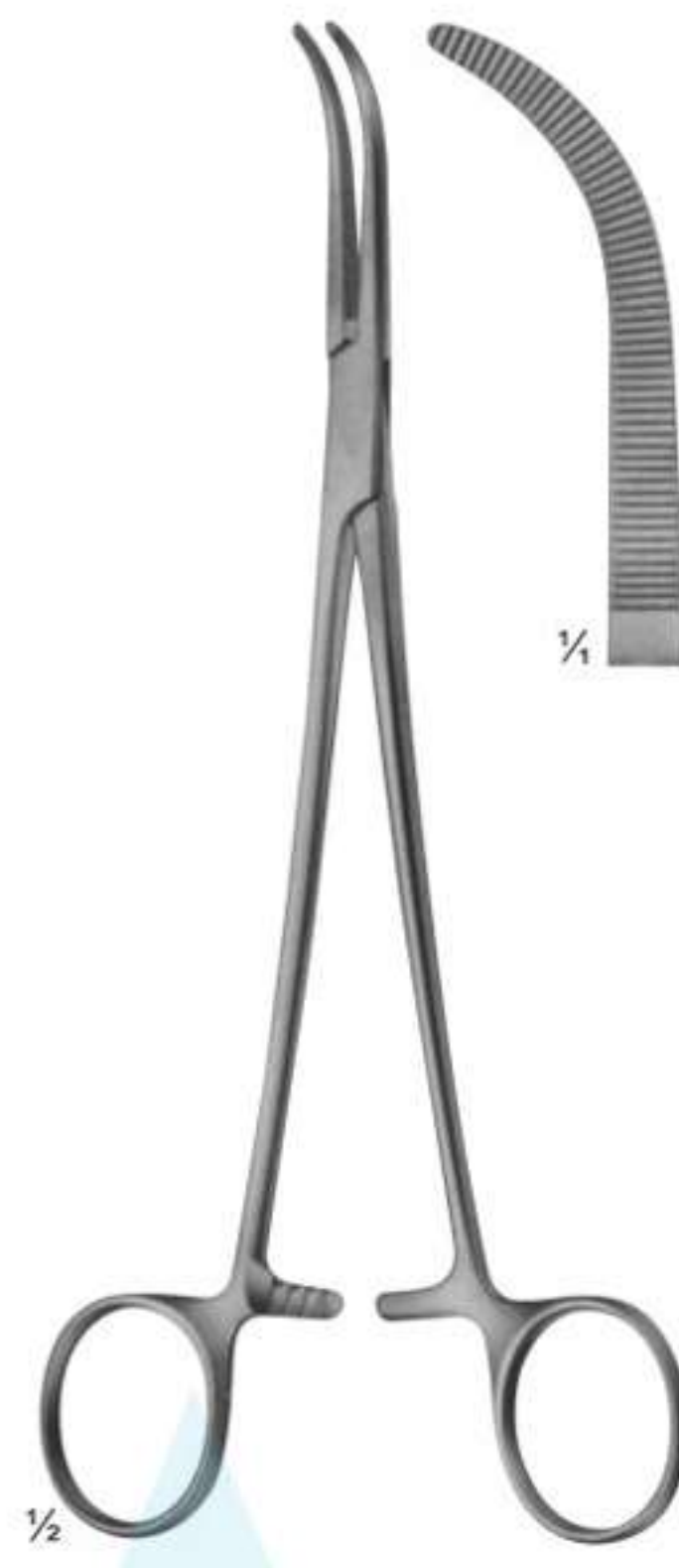

DMI-1-1602
HEISS 195 mm



DMI-1-1603
RUMEL 240 mm

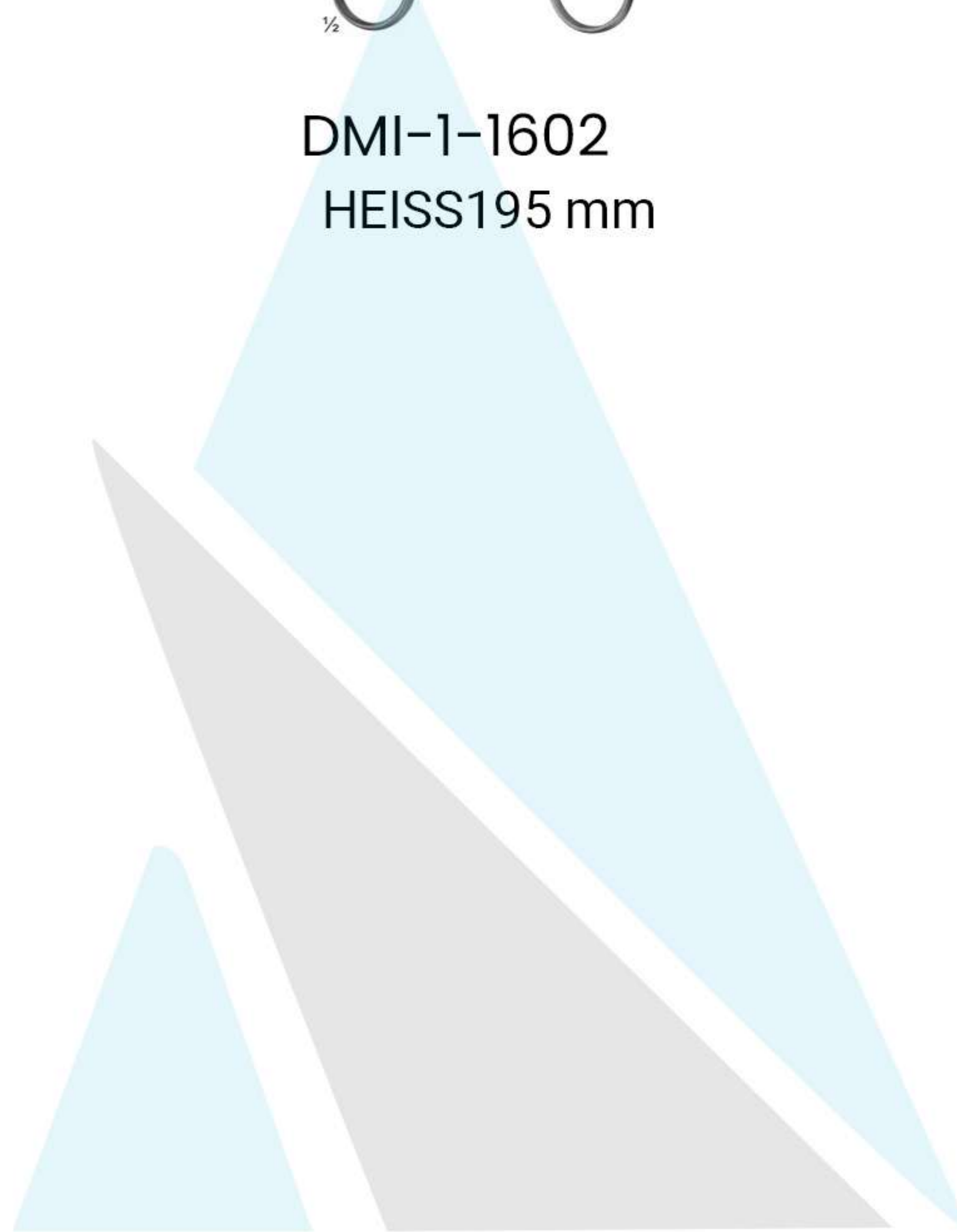

DMI-1-1604
RUMEL 240 mm



DMI-1-1605
RUMEL 240 mm



DMI-1-1606
RUMEL 240 mm

**Ligature, Hysterectomy and
Compression Forceps Vaginal Clamps**

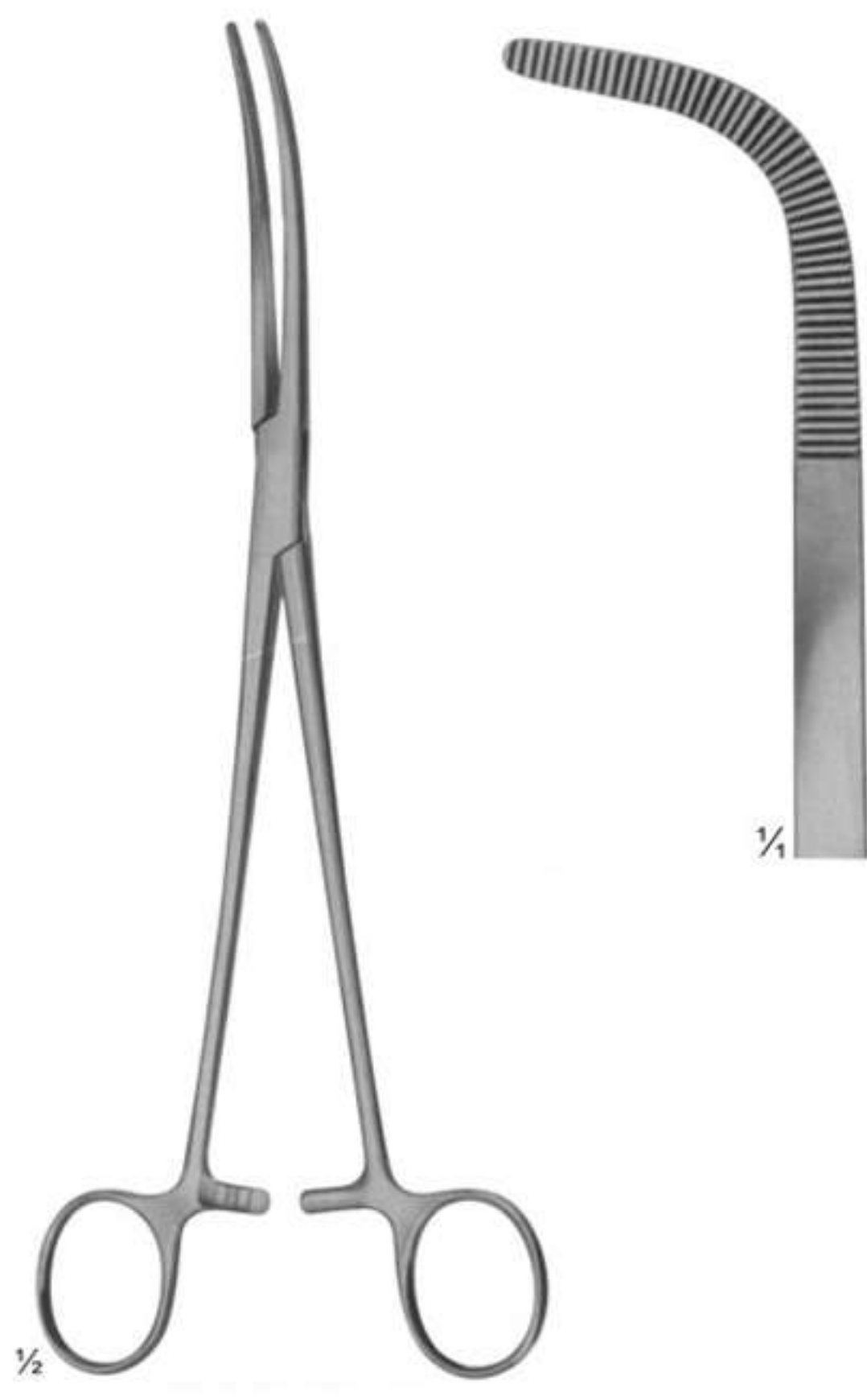

DMI-1-1607
RUMEL 240 mm



DMI-1-1608
FINOCHIETTO 245 mm



DMI-1-1609
MIXTER 230 mm



DMI-1-1610
LAWRENCE 270 mm



DMI-1-1611
ZENKER 300 mm



DMI-1-1612
ZENKER 290 mm

**Ligature, Hysterectomy and
Compression Forceps Vaginal Clamps**



DMI-1-1613
WERTHEIM Hysterectomy
forceps 255 mm

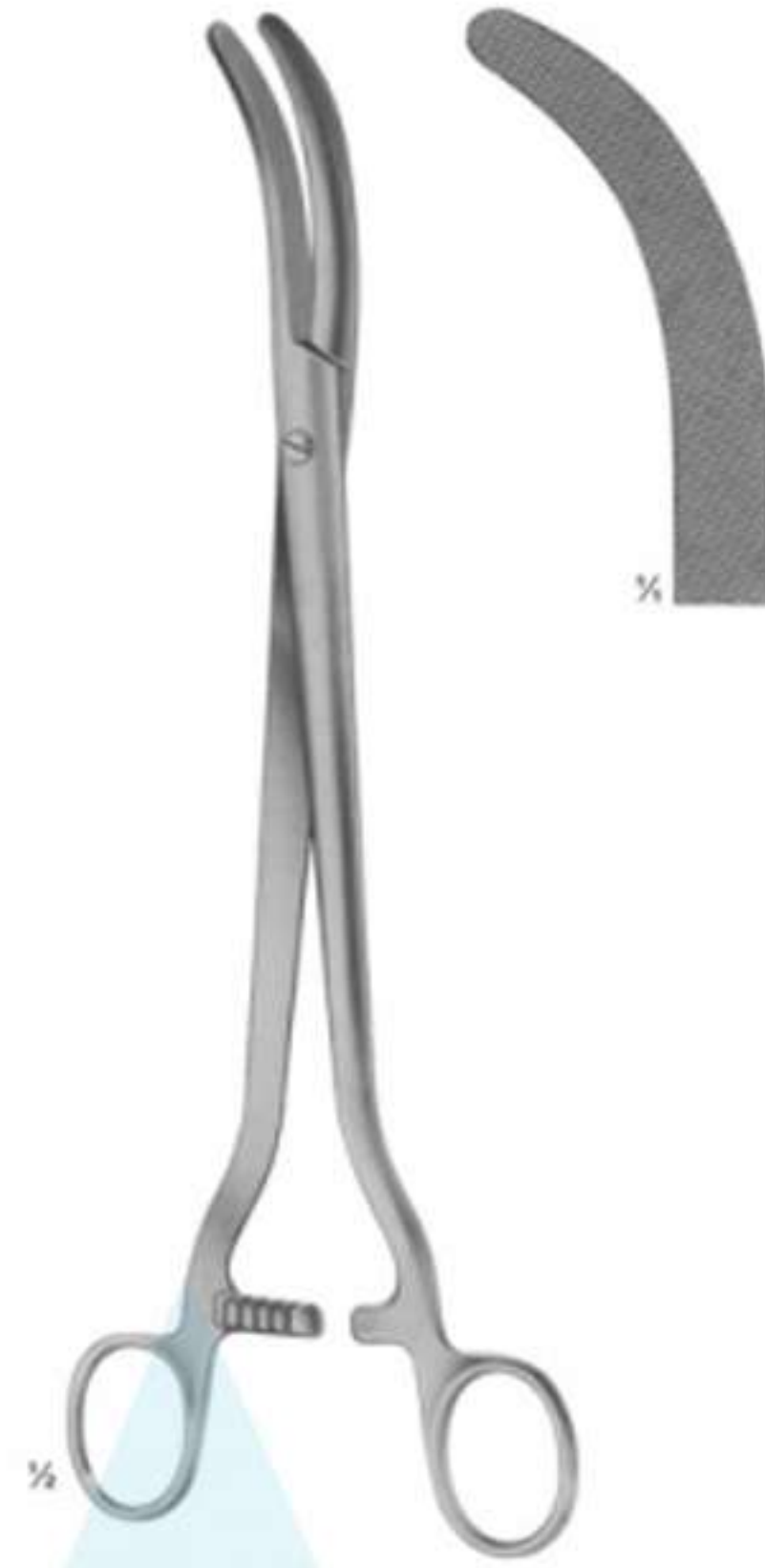

DMI-1-1614
WERTHEIM Parametrium
clamp 260 mm



DMI-1-1615
DICK 265 mm



DMI-1-1616
DICK 275 mm



DMI-1-1617
DICK 285 mm



DMI-1-1618
WERTHEIM 250 mm

**Ligature, Hysterectomy and
Compression Forceps Vaginal Clamps**



DMI-1-1619
WERTHEIM-CULLEN 215 mm



DMI-1-1620
60 mm



DMI-1-1621
80 mm



DMI-1-1701
ROHRSCHEIDER with copper
inserts 100 mm



DMI-1-1702
KALT with catch 135 mm



DMI-1-1703
ARRUGA with catch 135 mm



DMI-1-1704
CASTROVIEJO with catch 145 mm



DMI-1-1705
CASTROVIEJO with catch 145 mm



DMI-1-1706
without Catch 160 mm



DMI-1-1707
without Catch 160 mm



DMI-1-1708
without catch 185 mm



DMI-1-1709
without catch 185 mm



DMI-1-1710
JACOBSON 185 mm



DMI-1-1711
JACOBSON 185 mm



DMI-1-1712
without catch 195 mm

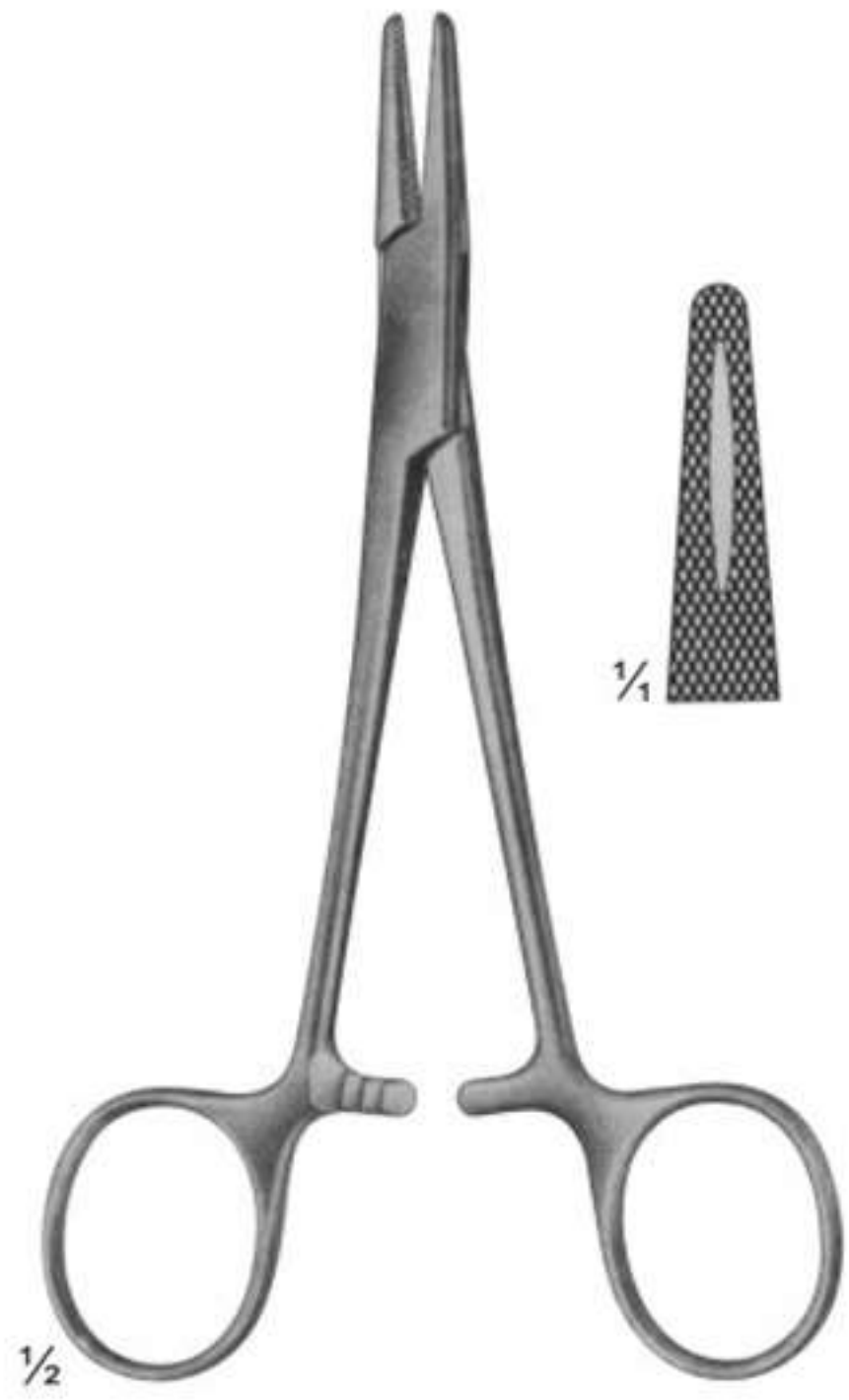

DMI-1-1719
HEGAR heavy patterns
175 mm

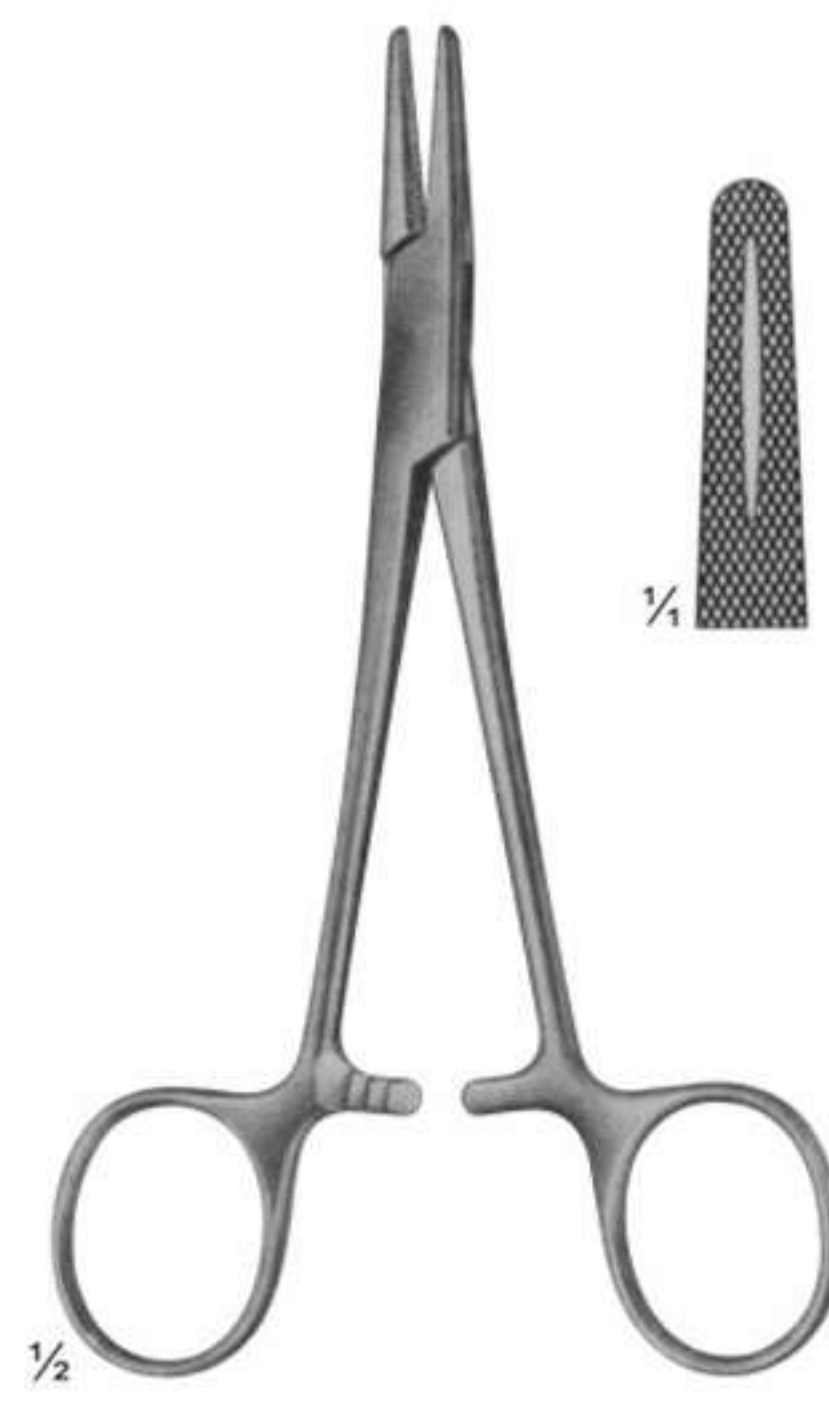

DMI-1-1720
HEGAR heavy patterns
205 mm



DMI-1-1721
HEGAR heavy patterns
205 mm



DMI-1-1722
HEANEY (HEGAR)
HEANEY (HEGAR) 200 mm



DMI-1-1723
JAMESON



DMI-1-1724
WANGENSTEEN 275 mm



DMI-1-1725
MASSON 265 mm

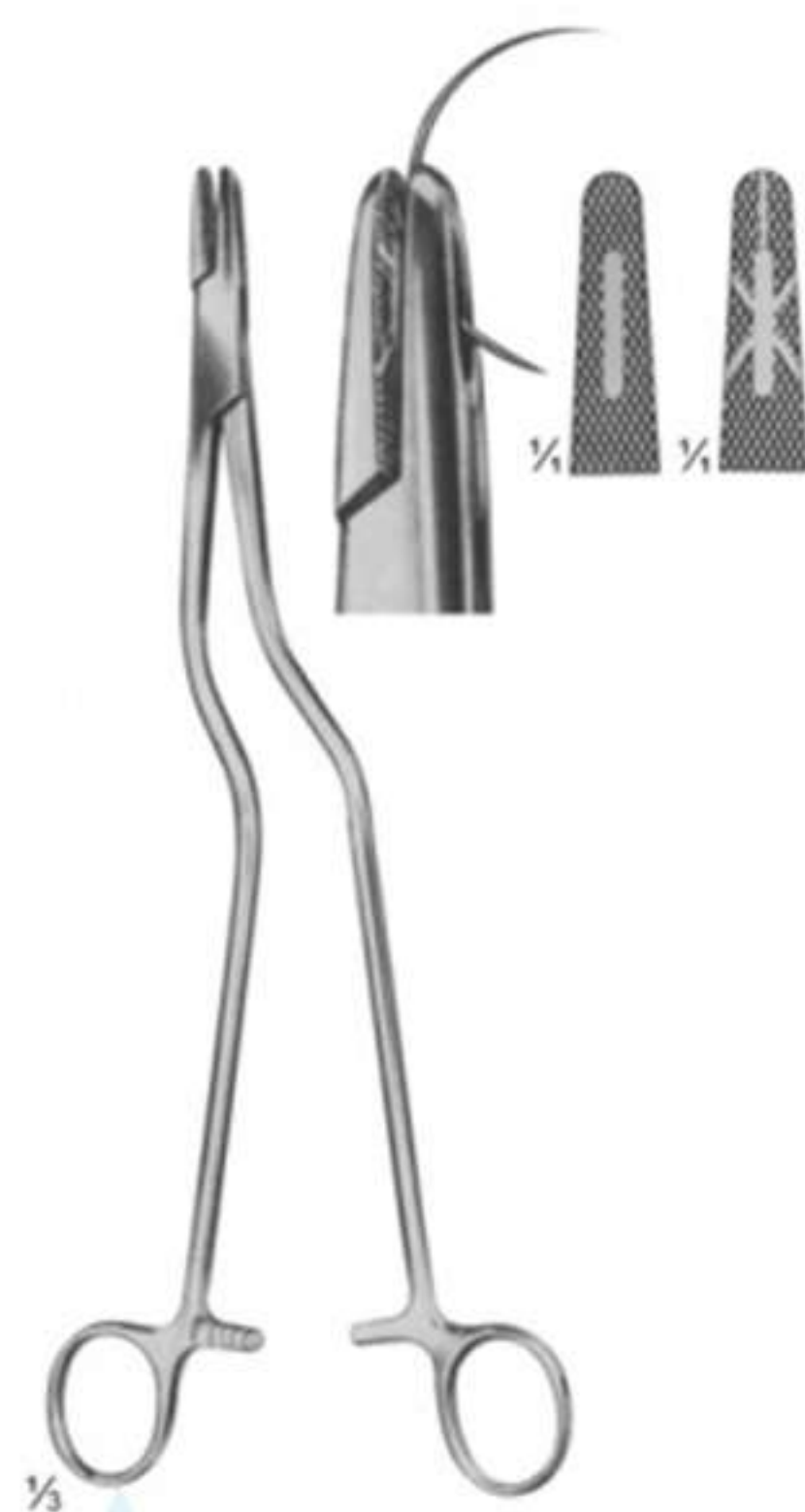

DMI-1-1726
MASSON-LUETHY 255 mm

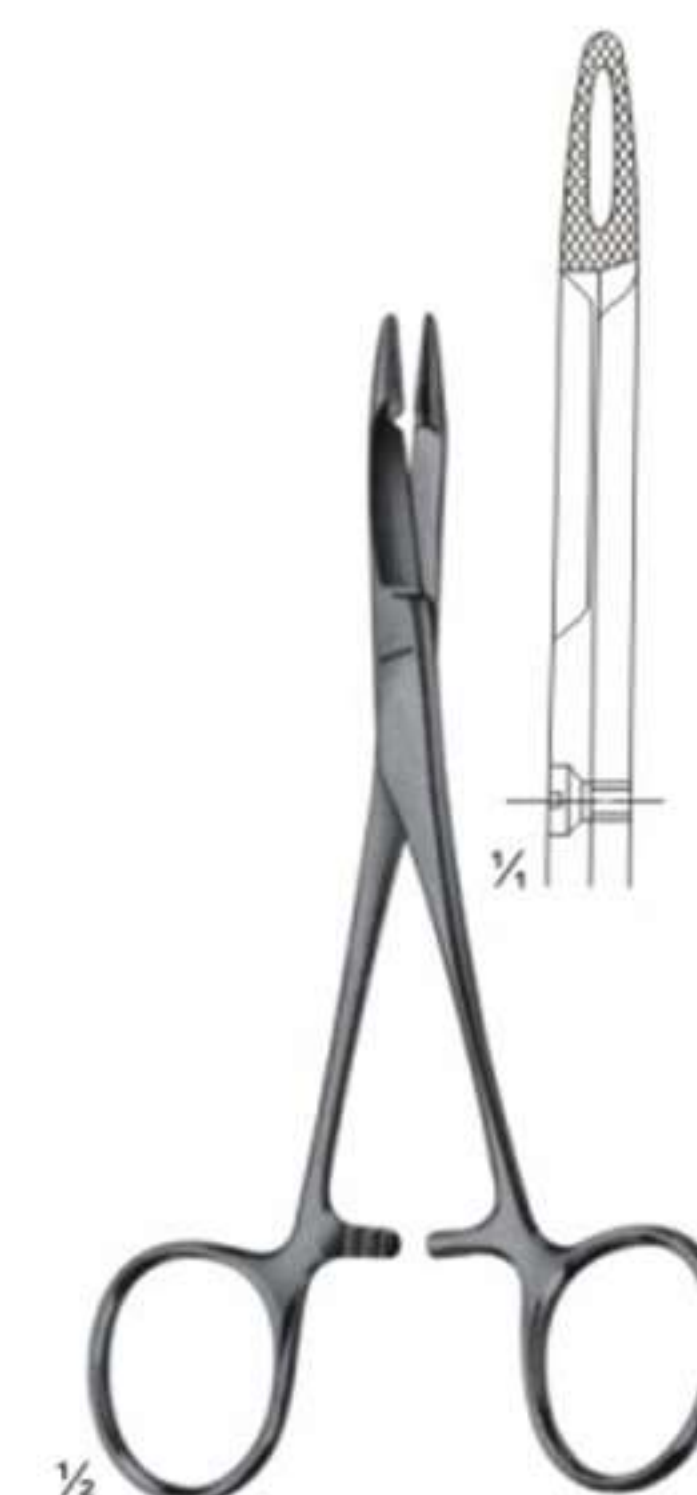

DMI-1-1727
HEGAR-OLSEN 140 mm

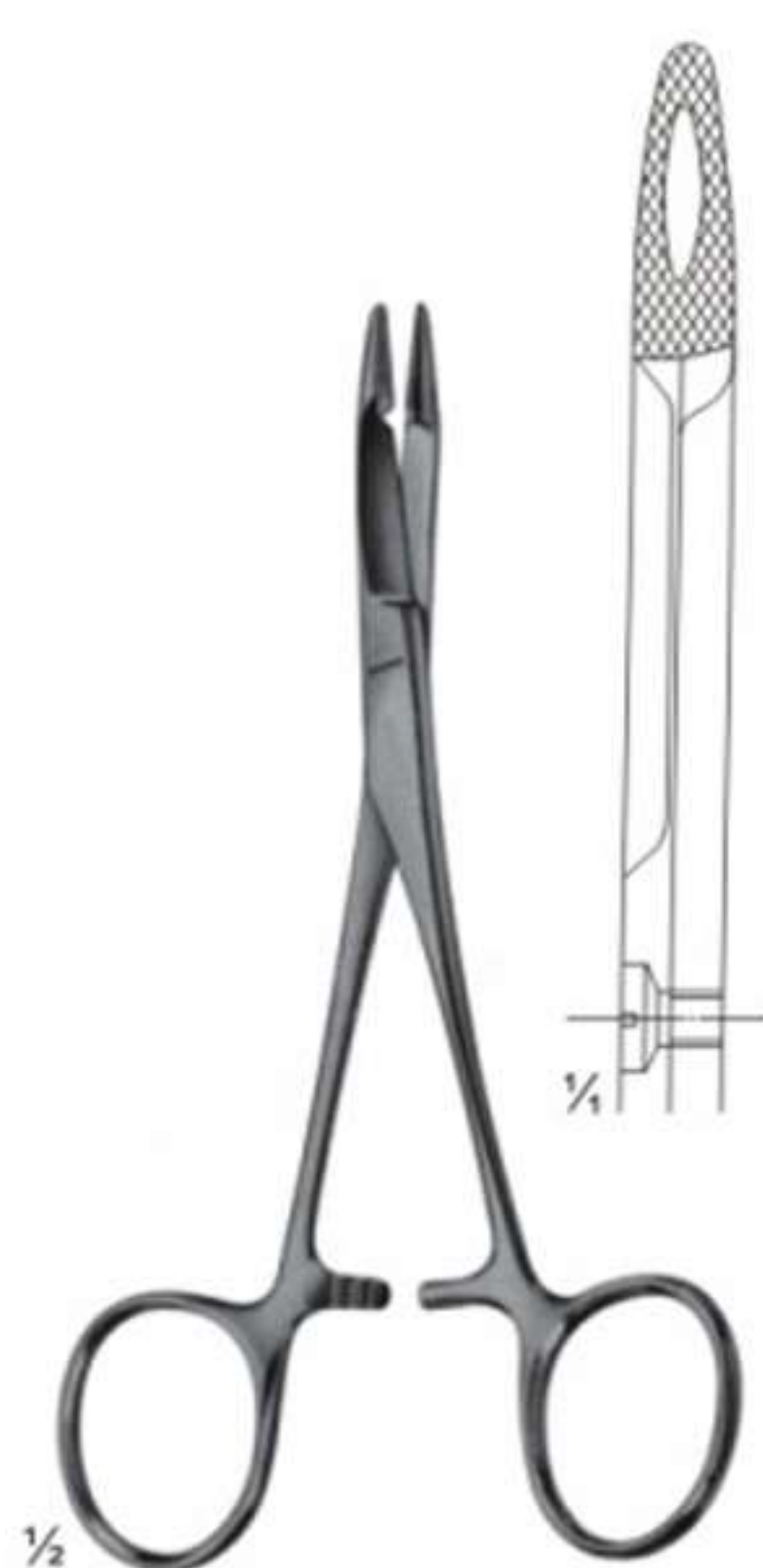

DMI-1-1728
HEGAR-OLSEN 180 mm

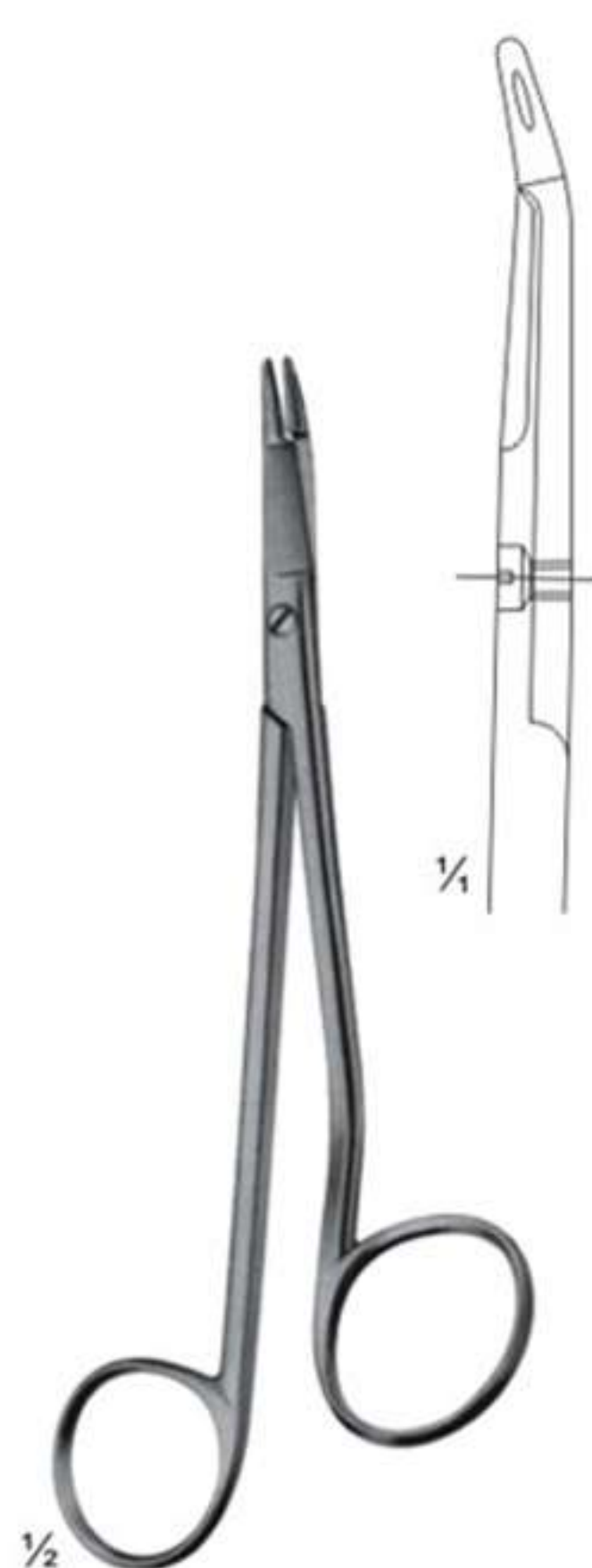

DMI-1-1729
GILLIES 150 mm



DMI-1-1730
GILLIES 160 mm

Needle Holders, Suture Instruments

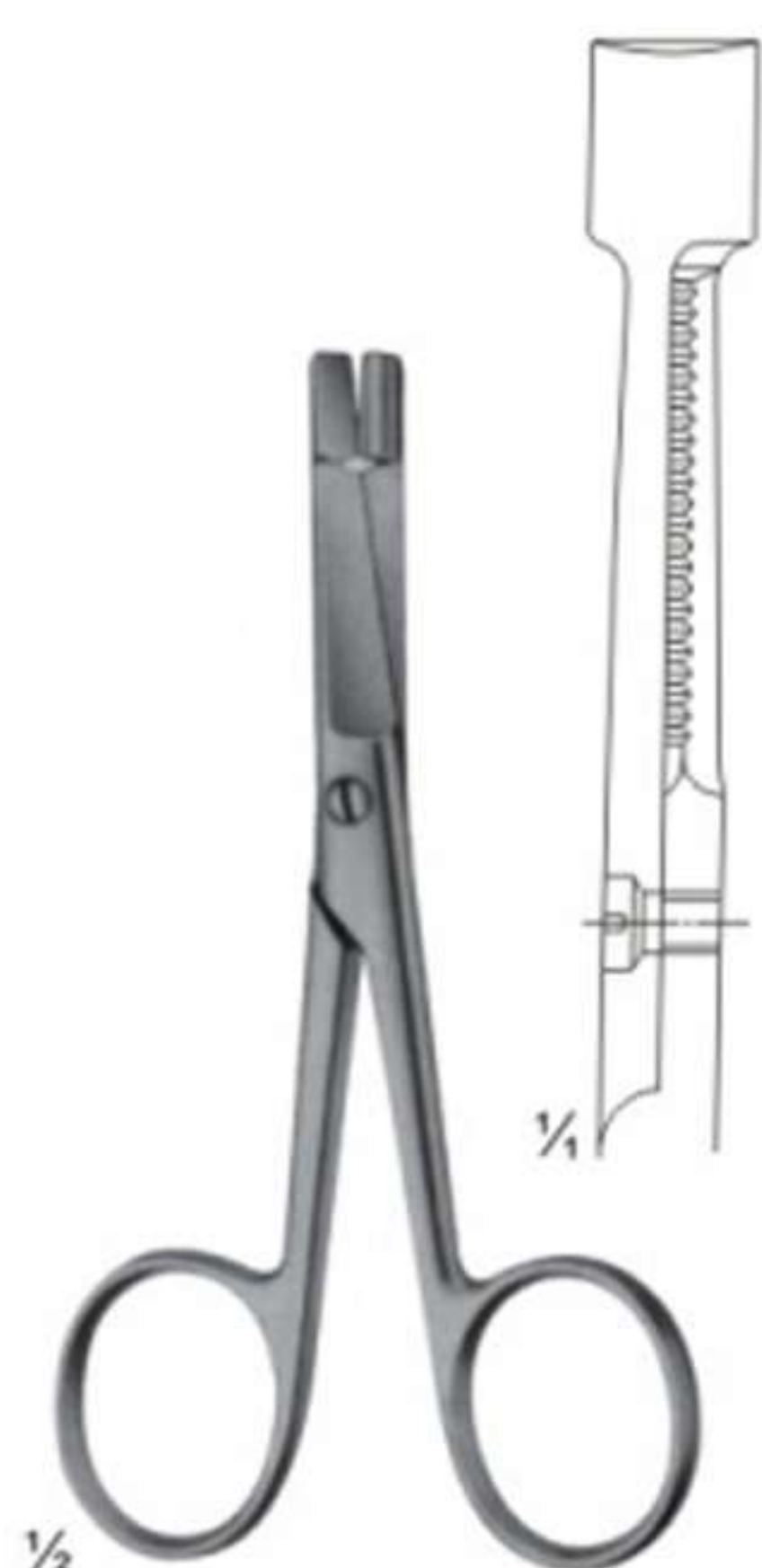

DMI-1-1731
EISELSBERG 115 mm

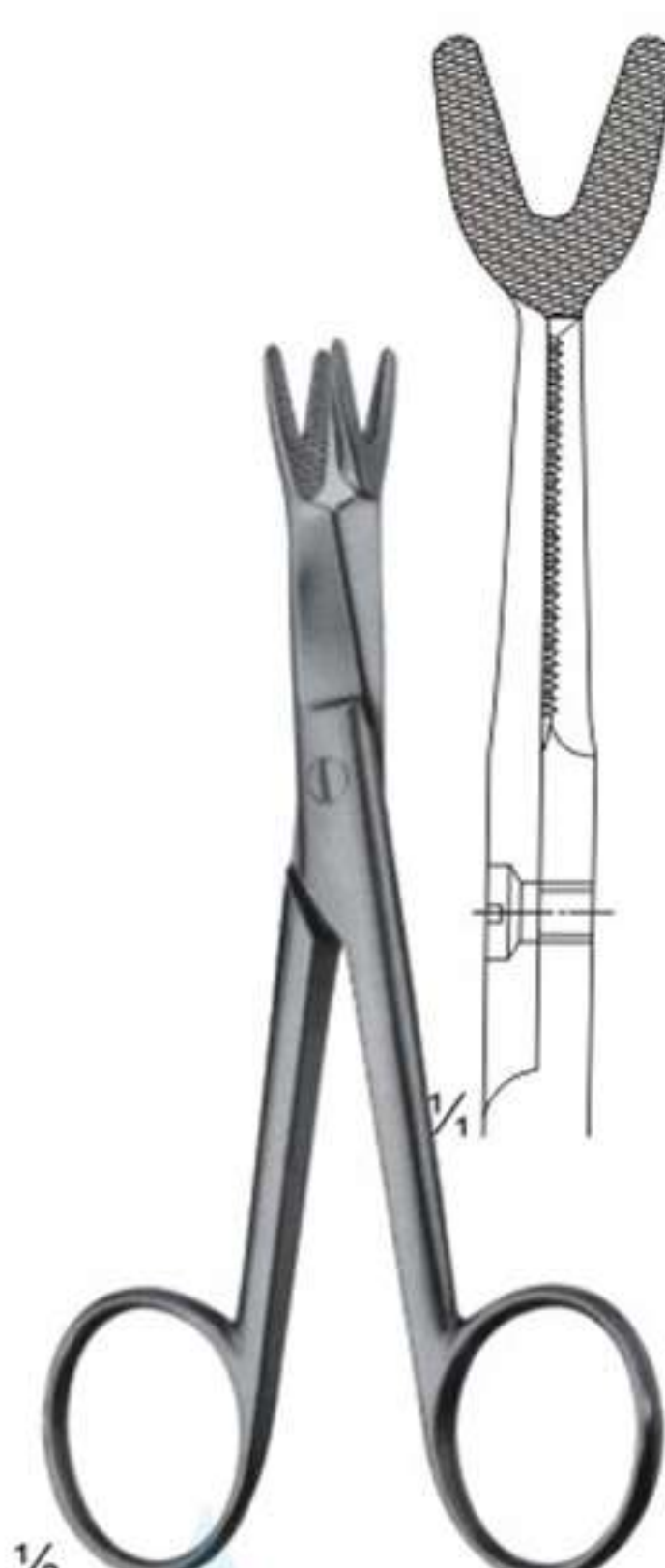

DMI-1-1732
SCHOEMAKER-LOTH 125 mm



DMI-1-1733
CRILE 150 mm



DMI-1-1734
TOENNI Elastic pattern for
dura-oriental suture. 180 mm



DMI-1-1735
MATHIEU 140 mm



DMI-1-1736
100 mm



DMI-1-1737
MATHIEU 200 mm



DMI-1-1738
MATHIEU-STILLE 200 mm



DMI-1-1739
MATHIEU-STILLE 200 mm



DMI-1-1740
BOYNTON 125 mm



DMI-1-1741
EISELSBERG-MATHIEU For
palate suture 195 mm



DMI-1-1742
200 mm



DMI-1-1743
250 mm



DMI-1-1744
Needle Holders, Suture Instruments



DMI-1-1745
Needle Holders, Suture Instruments



DMI-1-1746
Needle Holders, Suture Instruments



DMI-1-1747
YOUNG-HRYNTSCHAK With 1
needle 240 mm



DMI-1-1748
YOUNG-MILLIN With 1 needle 200 mm



DMI-1-1749
MILLIN Ligature holding forceps.
245 mm



DMI-1-1750
KRONECKER for right hand
blunt 155 mm



DMI-1-1751
KRONECKER for left hand
blunt 155 mm

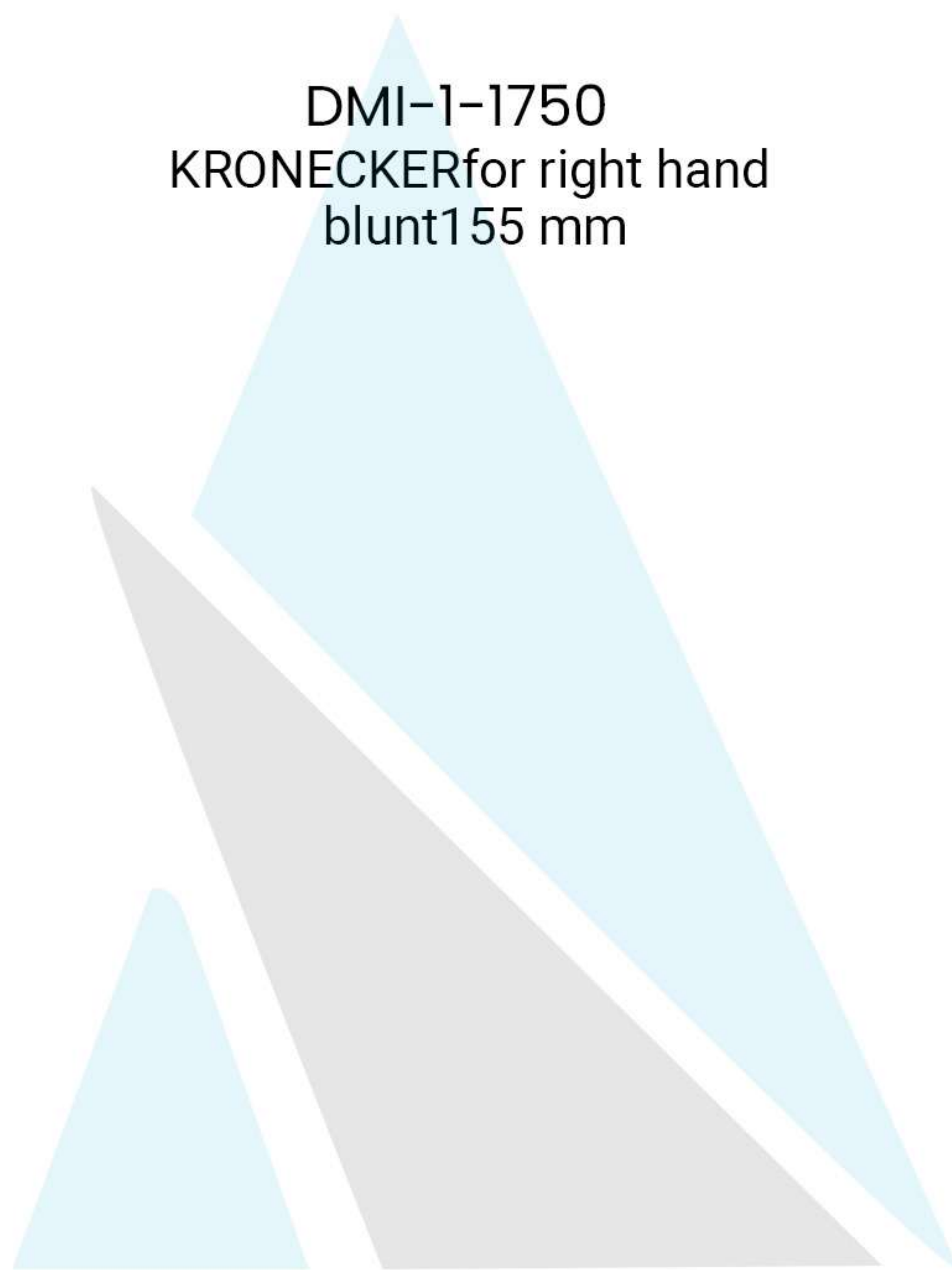

DMI-1-1752
DESCHAMPS for right hand steep
turn blunt 225 mm



DMI-1-1753
DESCHAMPS for right hand
steep turn blunt 225 mm



DMI-1-1754
DESCHAMPS for right hand steep
turn blunt 225 mm



DMI-1-1755
DESCHAMPS for left hand
steep turn blunt 225 mm



DMI-1-1756
DESCHAMPS for right hand
steep turn blunt 230 mm



DMI-1-1757
DESCHAMPS for left hand steep
turn blunt 230 mm



DMI-1-1758
DESCHAMPS for right hand
blunt 215 mm



DMI-1-1759
DESCHAMPS for left hand
blunt 215 mm



DMI-1-1760
DESCHAMPS for left hand
blunt 215 mm



DMI-1-1761
DESCHAMPSfor right hand
blunt 210 mm



DMI-1-1762
DESCHAMPSfor left handblunt.
210 mm



DMI-1-1801
Directors 130 mm



DMI-1-1802
Directors 145 mm



DMI-1-1803
Directors 160 mm



DMI-1-1804
DOYEN 145 mm Directors



DMI-1-1805
NELATON 160 mm Directors



DMI-1-1806
Director with tip Diam. of tip 3,3 mm 140 mm



DMI-1-1807
Director with tip Diam. Of tip
3,3 mm 140 mm

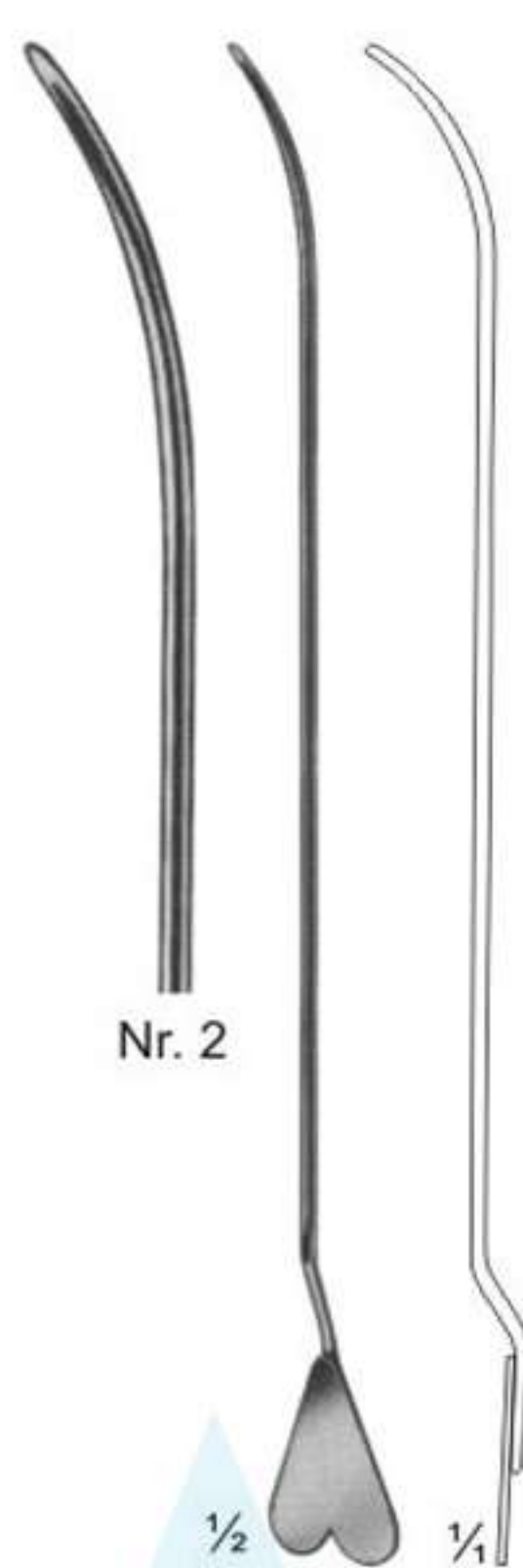

DMI-1-1808
BRODIE Director with tip, Diam.
Of tip 3,5 mm 200 mm



DMI-1-1809
LOCKHART-MUMMERY 165 mm

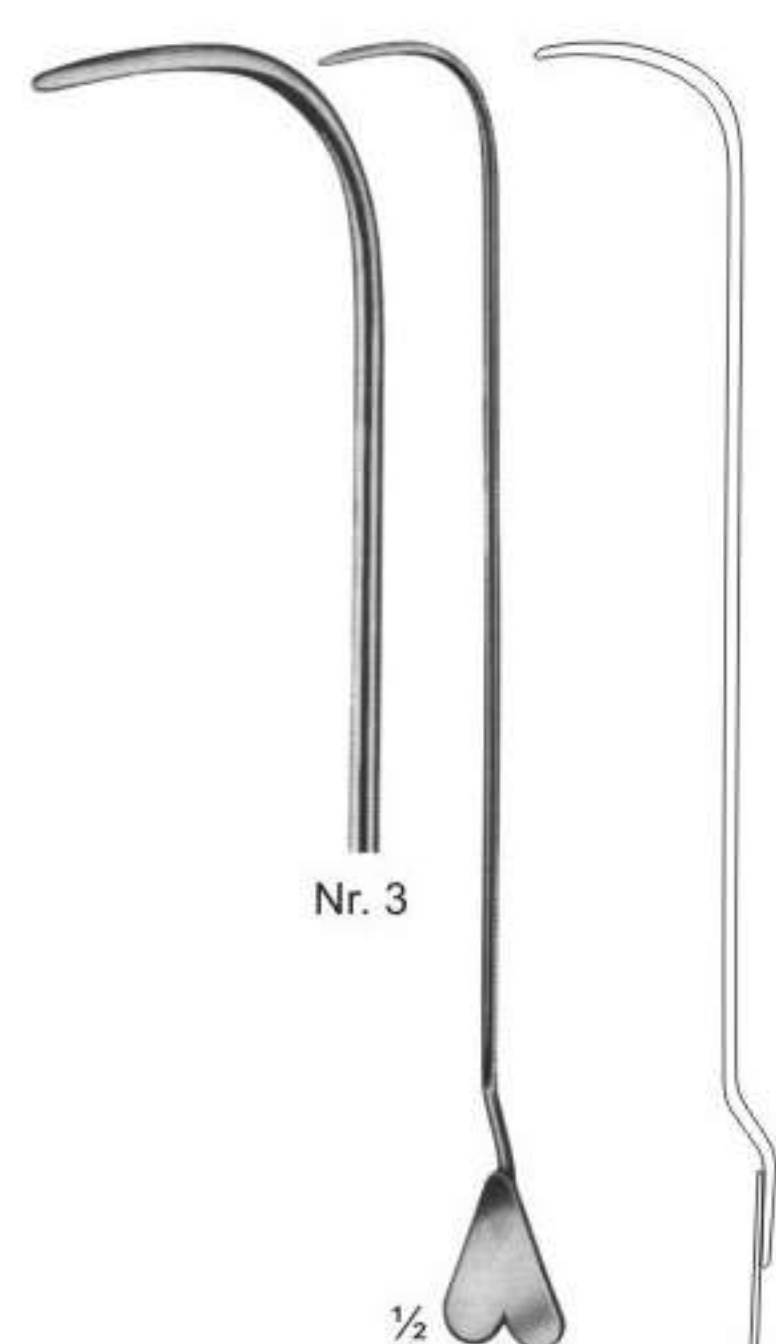

DMI-1-1810
LOCKHART-MUMMERY 165 mm

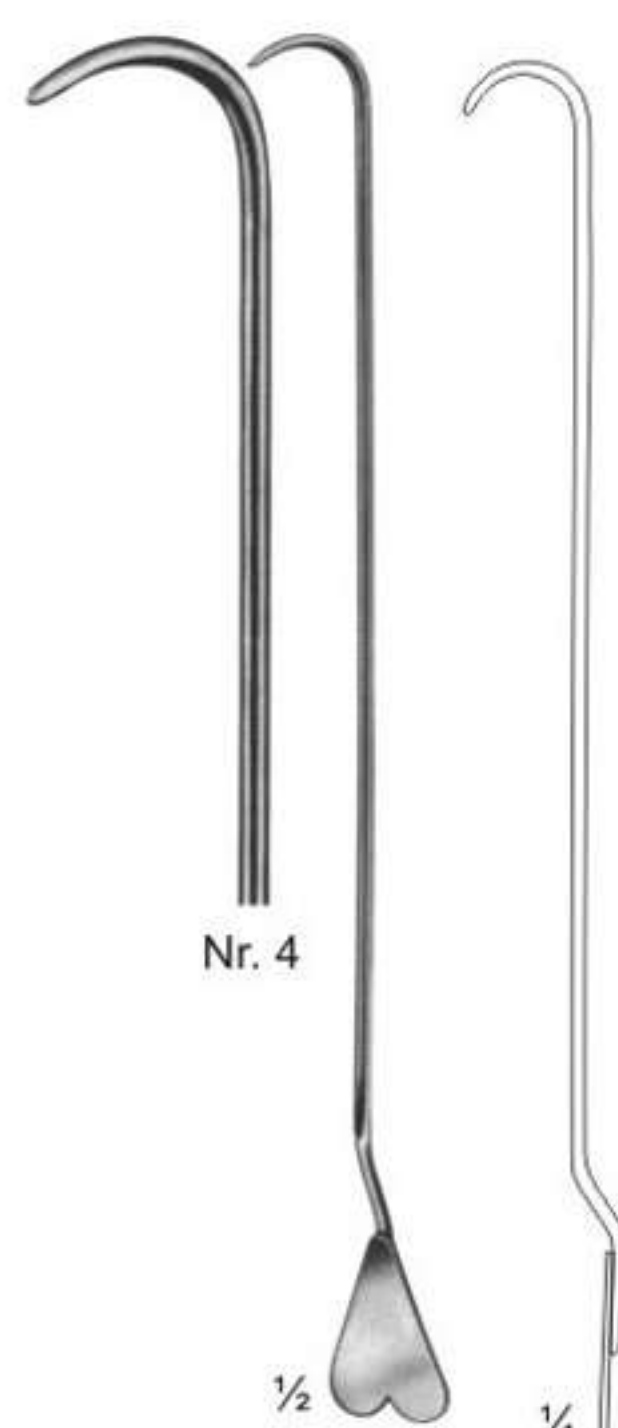

DMI-1-1811
LOCKHART-MUMMERY 165 mm



DMI-1-1812
Director with wire loop, malleable
190 mm



DMI-1-1813
145 mm



DMI-1-1814
Probes with eye 160 mm



DMI-1-1815
Probes with eye 200 mm

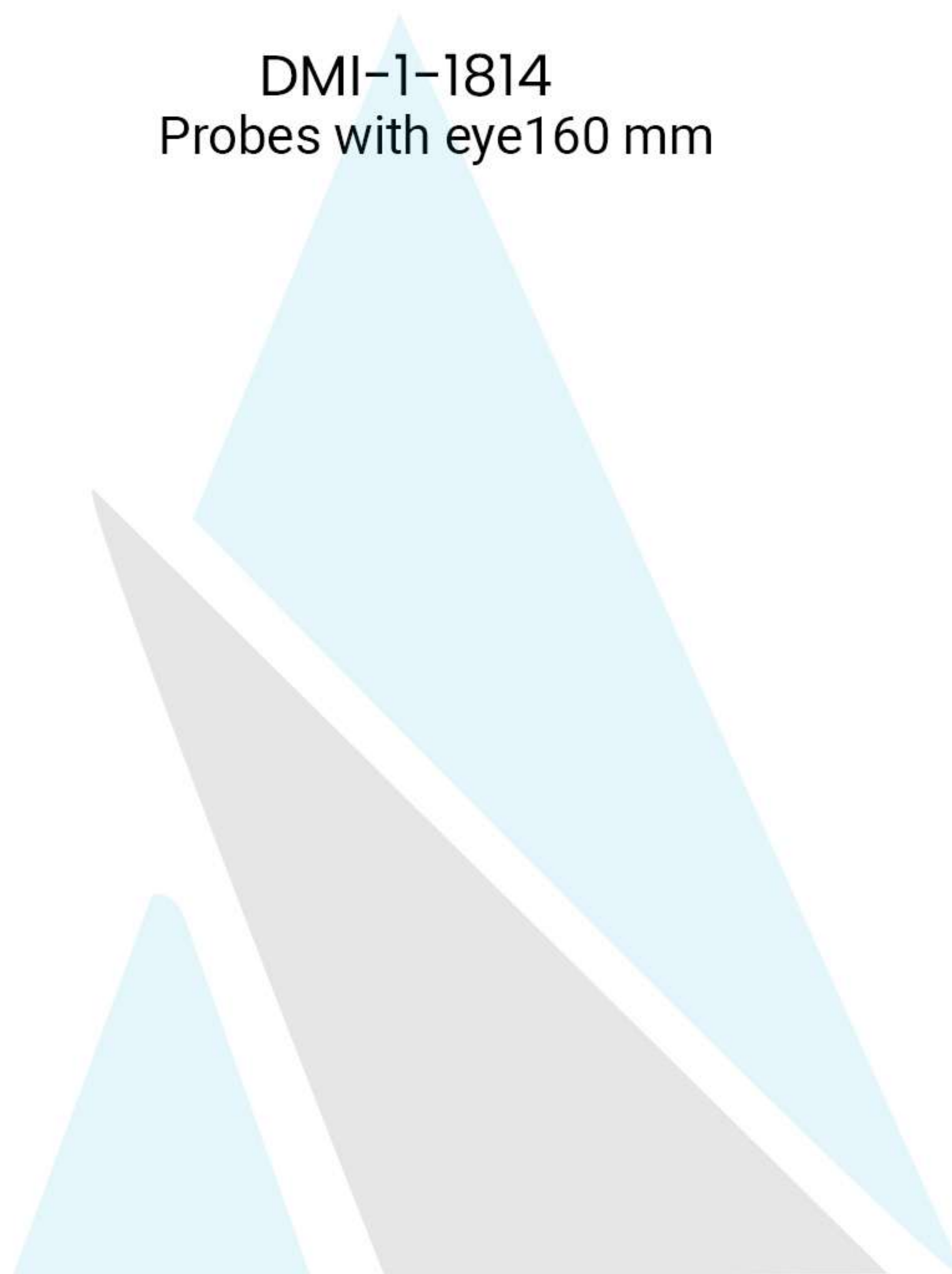

DMI-1-1816
Myrtle leaf probe 145 mm



DMI-1-1817
130 mm



DMI-1-1818
145 mm



DMI-1-1819
160 mm



DMI-1-1820
180 mm



DMI-1-1821
200 mm

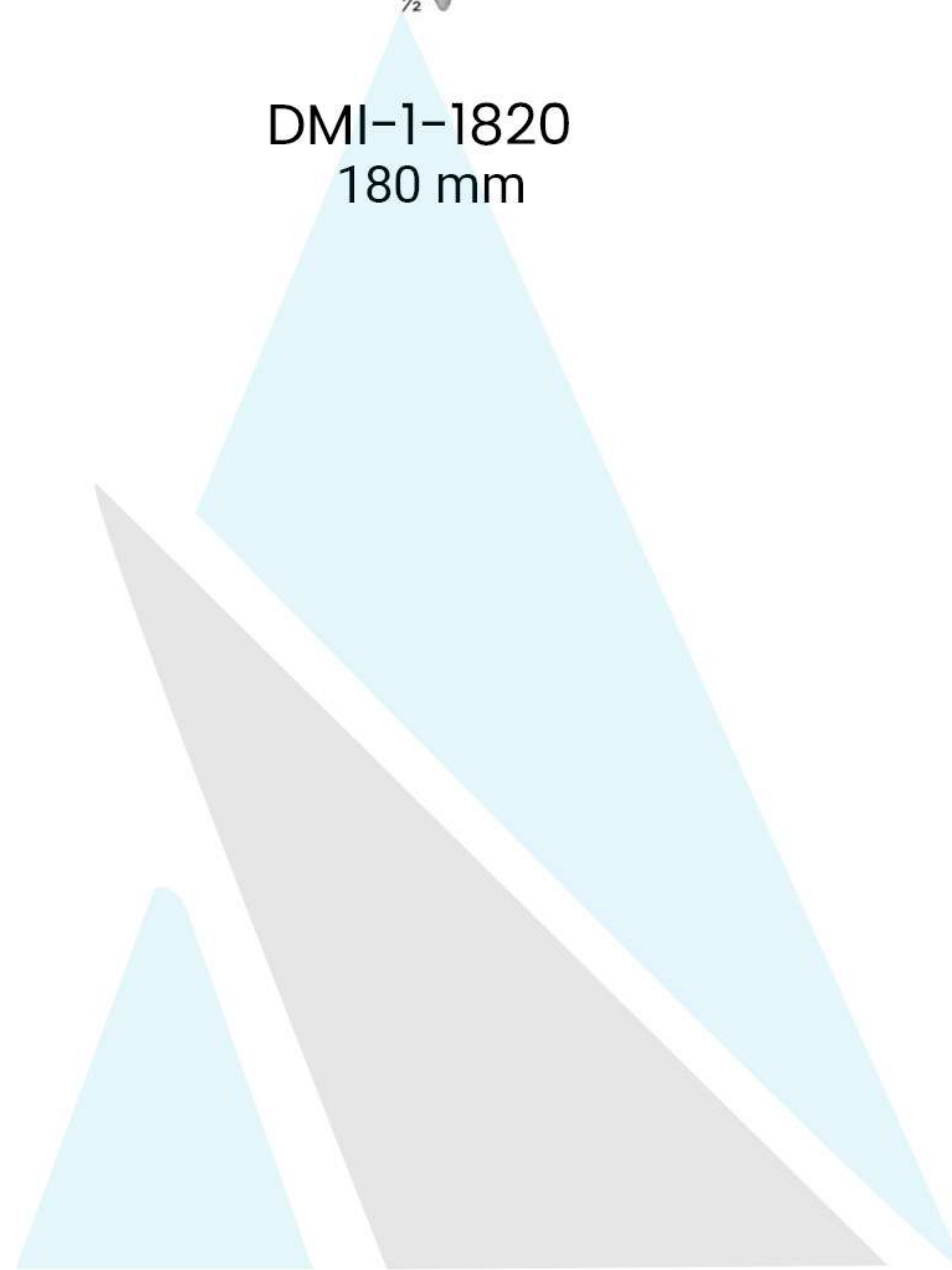

DMI-1-1822
Probes



DMI-1-1823
Double ended probe, malleable,
diam. of tips 3 mm with hole 190 mm



DMI-1-1824
Double ended probes, tin, malleable,
diam. of tips 3,5 mm with hole
250 mm, 300 mm

Probes, Pocket Instruments Sets



DMI-1-1825
Double ended probes, tin, malleable, diam. of tips 4 mm 400 mm



DMI-1-1826
150 mm



DMI-1-1827
Suturing instruments set, in metal case consisting of: Scissors, curved, sharp/sharp, 115mm 25 MICHEL clip, 16 x 3mm 1 Delicate tissue forceps, 130mm 1 Scalpel, bellied 1 MATHIEU needle holder, 140mm 1 Perforated metal case, stainless containing: 1 Suture needle 1 item 1 item



DMI-1-1828
Pocket instrument set, in metal case consisting of: Bottom tray 1 MATHIEU needle holder, 140mm 1 MICHEL clip forceps, combined 1 Myrtle leaf probe, 130mm 1 Sharp double curette 1 Skin hook 1 Detachable scalpel handle, no. 4 1 Perforated metal case, containing 6 Scalpel blades 1 Perforated metal case, stainless, containing 1 Suture needle 1 item 1 item



DMI-1-1829
Pocket instrument set, in metal case consisting of: Bottom tray 1 MAYO-HEGER needle holder, 150mm 1 MICHEL clip forceps, combined 1 Myrtle leaf probe, 130mm 1 Sharp double curette 1 Skin hook 1 Detachable scalpel handle, no. 4 1 Perforated metal case, containing 6 Scalpel blades 1 Perforated metal case, stainless, containing: 1 Suture needle 1 item, & 1 item



DMI-1-1901
GRAEFE 125 mm

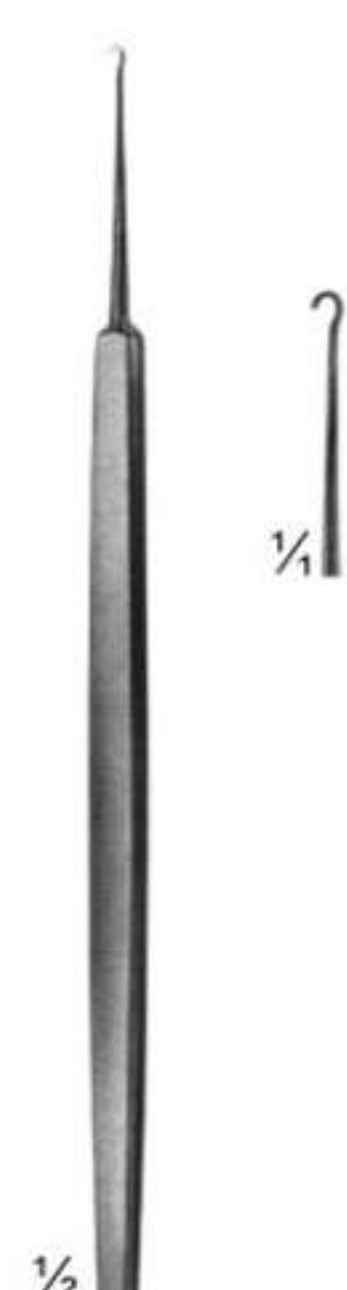

DMI-1-1902
GRAEFE GRAEFE 125 mm



DMI-1-1903
GUTHRIE 125 mm



DMI-1-1904
GUTHRIE 130 mm



DMI-1-1905
ROLLET 130 mm



DMI-1-1906
ROLLET 135 mm

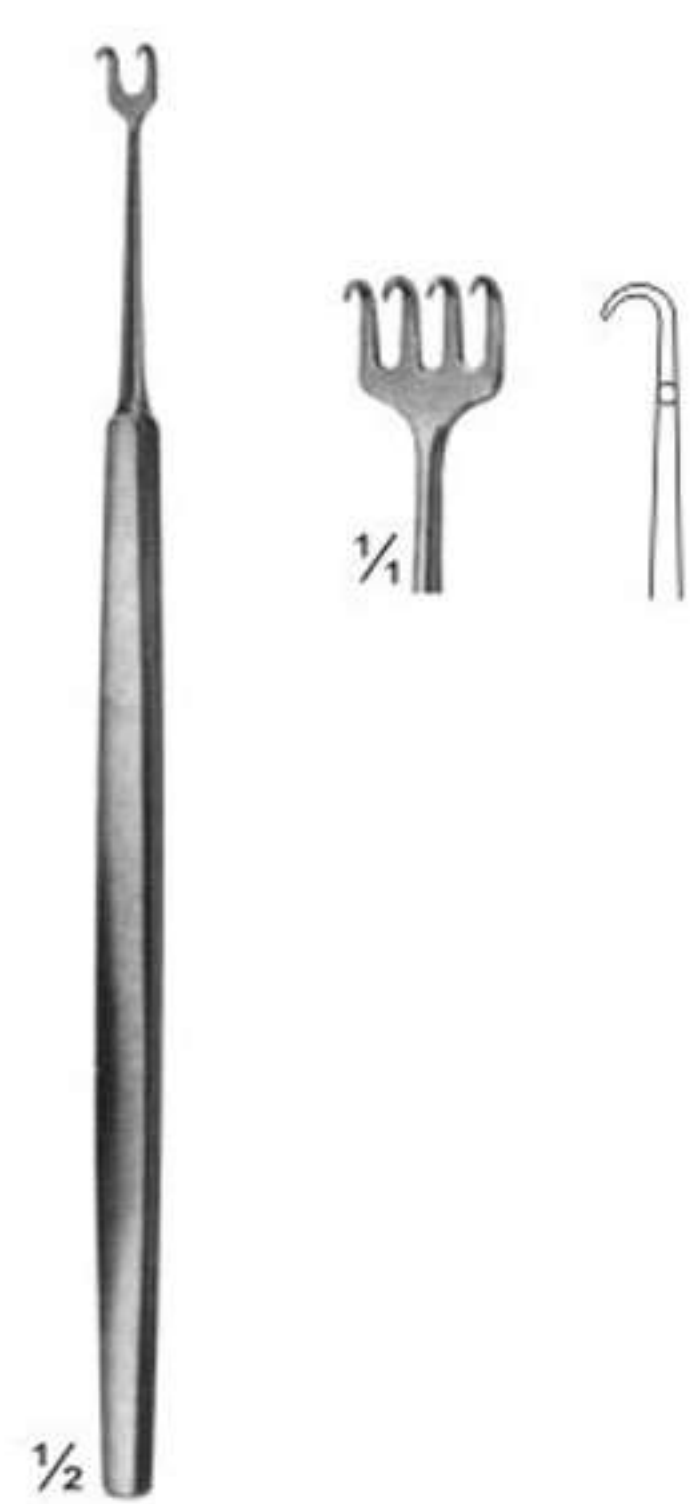

DMI-1-1907
ROLLET 135 mm



DMI-1-1908
FRAZIER Dura retractors 130 mm



DMI-1-1909
TONNIS Dura retractors 150 mm

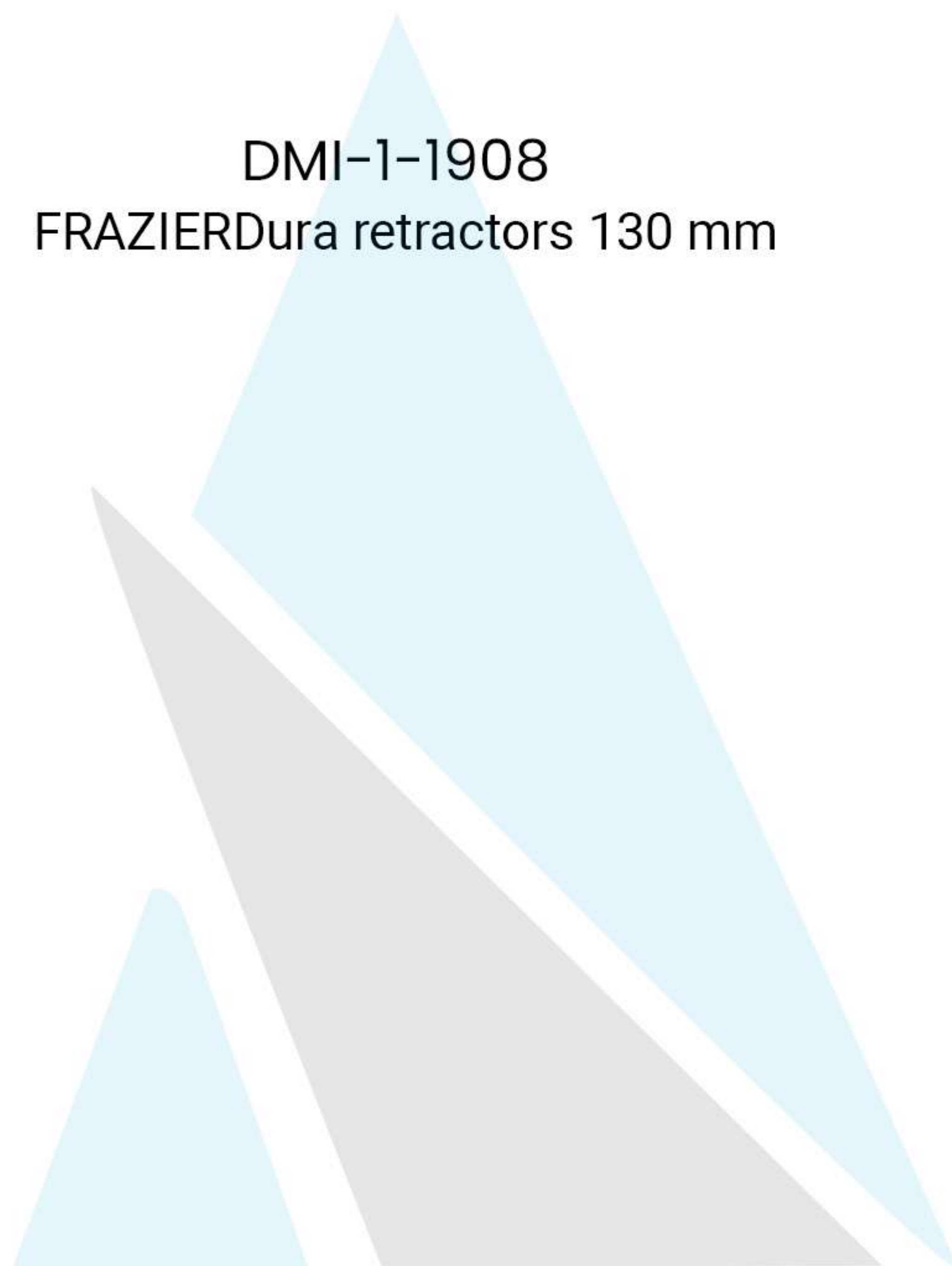

DMI-1-1910
KILNER 160 mm

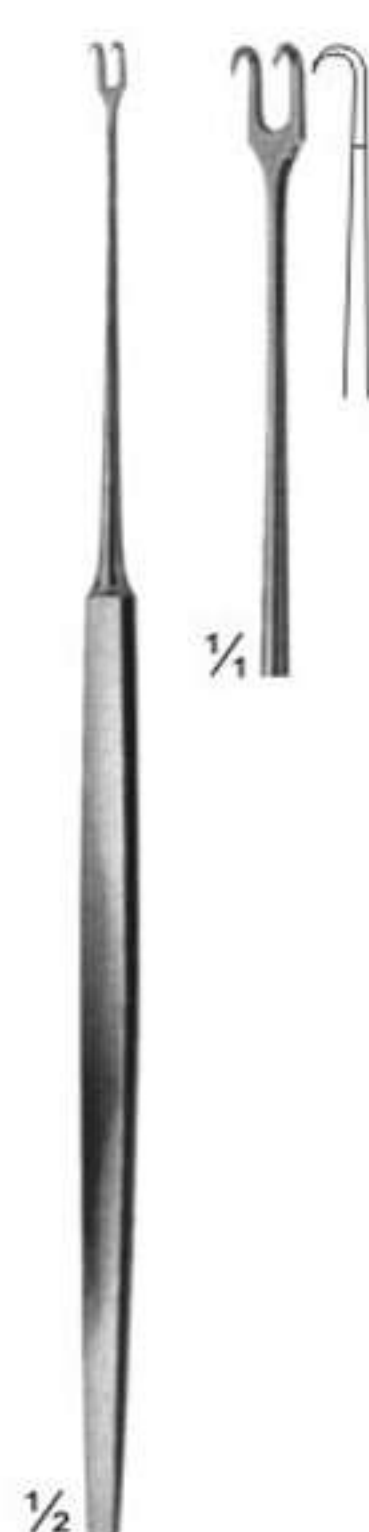

DMI-1-1911
FREER 150 mm



DMI-1-1912
MULLER 150 mm



DMI-1-1913
MULLER150 mm

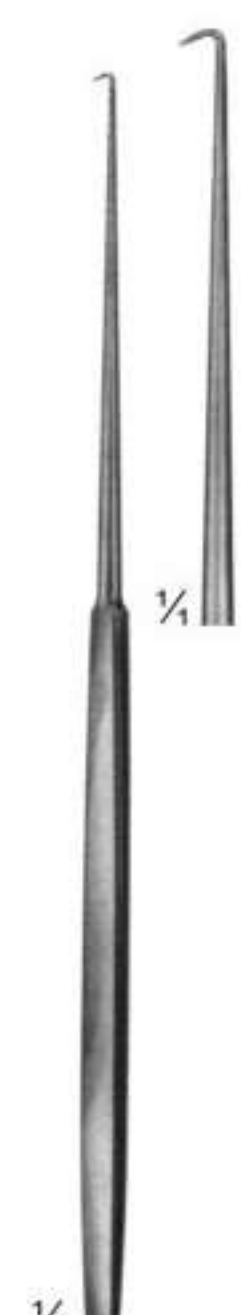

DMI-1-1914
COTTLE160 mm



DMI-1-1915
COTTLE160 mm



DMI-1-1916
JAEGER135 mm



DMI-1-1917
JOSEPH165 mm



DMI-1-1918
3 mm

Wound Retractors



DMI-1-1919
6 mm



DMI-1-1920
8 mm



DMI-1-1921
GILLIES 180 mm



DMI-1-1922
GILLIES 180 mm



DMI-1-1923
KILNER sharp 80 mm



DMI-1-1924
CONVERSE blunt 120 mm



DMI-1-1925
MANNERFELT modif.
sharp 135 mm



DMI-1-1926
MANNERFELT modif. sharp 155 mm



DMI-1-1927
MANNERFELT modif. sharp 155 mm



DMI-1-1928
MANNERFELT modif. small
curve, sharp 155 mm



DMI-1-1929
MANNERFELT modif. small curve,
sharp 155 mm



DMI-1-1930
MANNERFELT modif. small curve,
sharp 155 mm



DMI-1-1931
MANNERFELT modif.large
curve, blunt 155 mm



DMI-1-1932
MANNERFELT modif.large curve,
blunt 155 mm



DMI-1-1933
MANNERFELT modif.large curve,
blunt 155 mm



DMI-1-1934
LANGENBECK-MANNERFELT
modif.15 x 6 mm



DMI-1-1935
LANGENBECK-MANNERFELT
modif.155 mm



DMI-1-1936
LANGENBECK-MANNERFELT
modif.155 mm



DMI-1-1937
LANGENBECK-MANNERFELT
modif. 155 mm



DMI-1-1938
MANNERFELT modif. Saddle
hooks, 155 mm



DMI-1-1939
MANNERFELT modif. Saddle
hooks, 155 mm



DMI-1-1940
MANNERFELT modif. Saddle
hooks, 155 mm



DMI-1-1941
MANNERFELT modif. Saddle hooks,
fenestrated 155 mm



DMI-1-1942
COTTLE 140 mm



DMI-1-1943
COTTLE 140 mm



DMI-1-1944
DESMARRES 140 mm

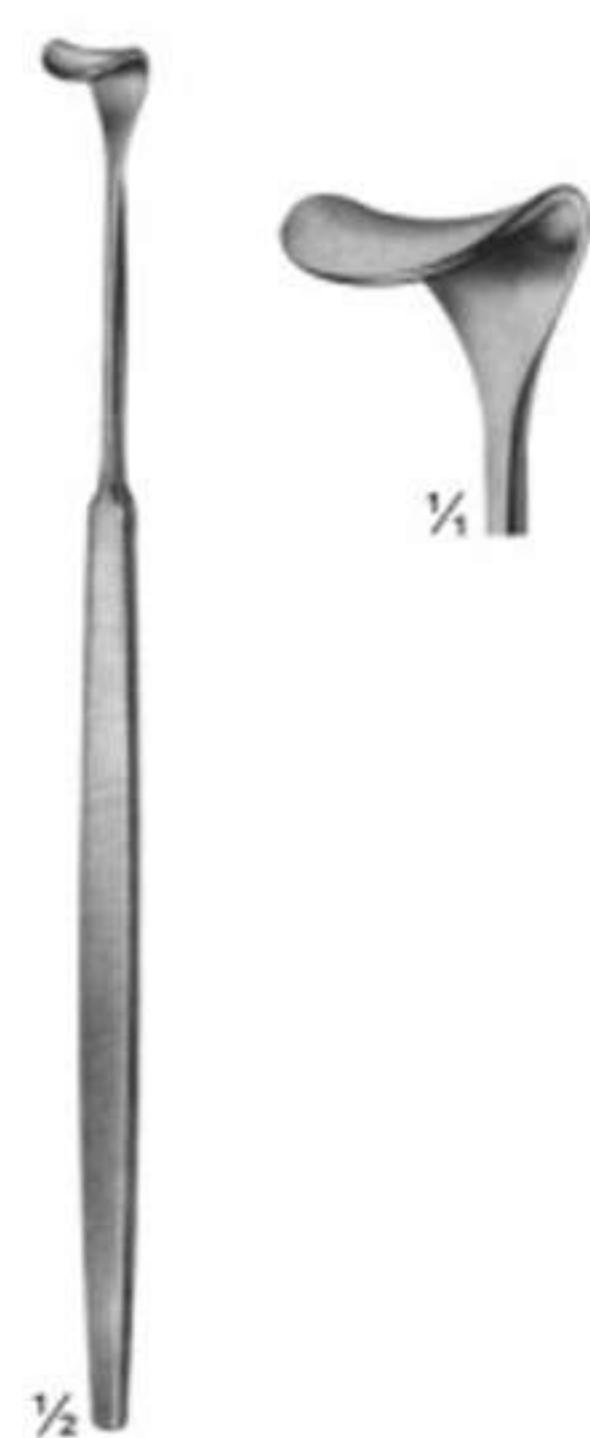

DMI-1-1945
DESMARRES 140 mm

**Self Retaining Retractors,
Abdominal Retractors**

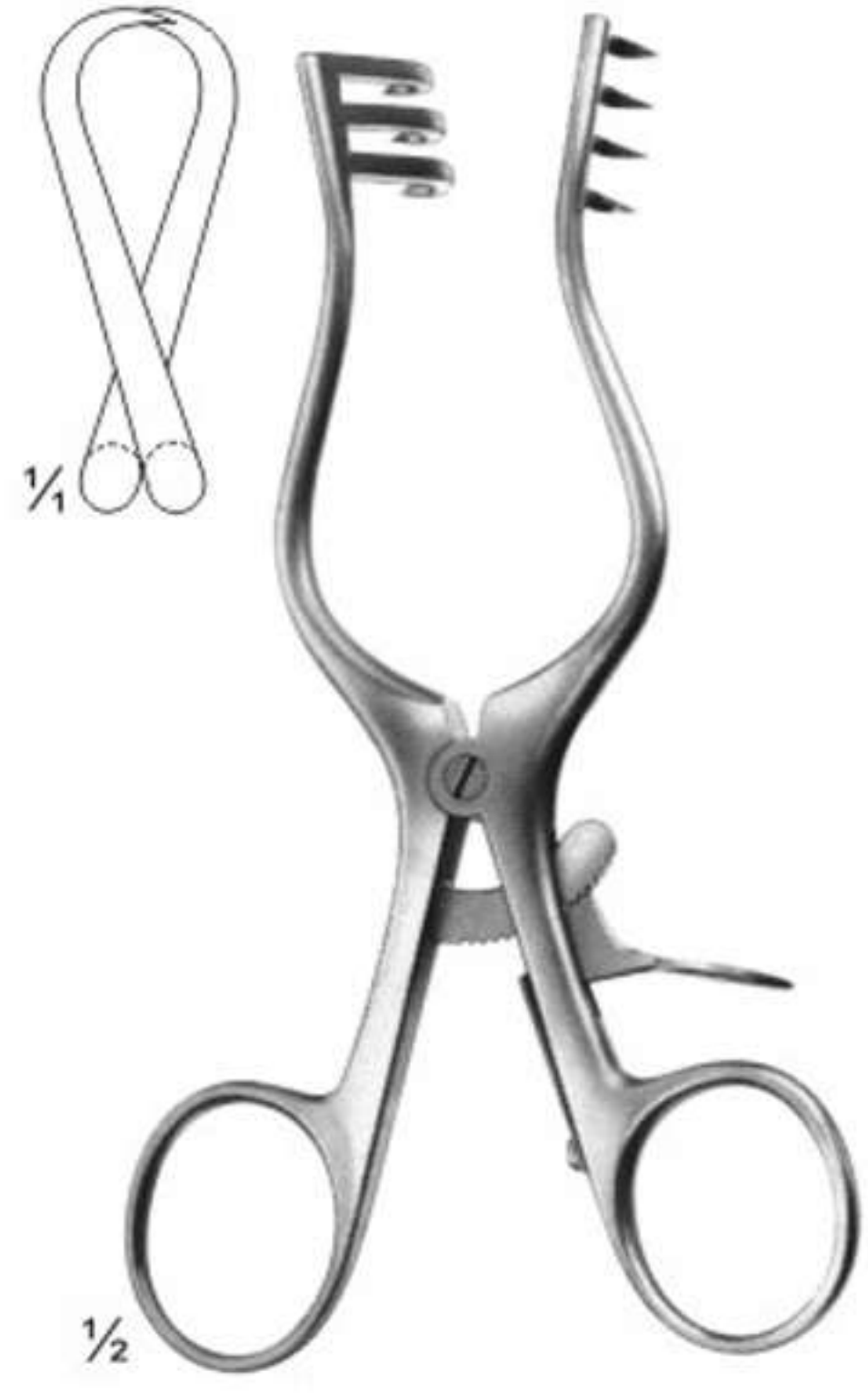

DMI-1-2001
WEITLANERsharp130 mm

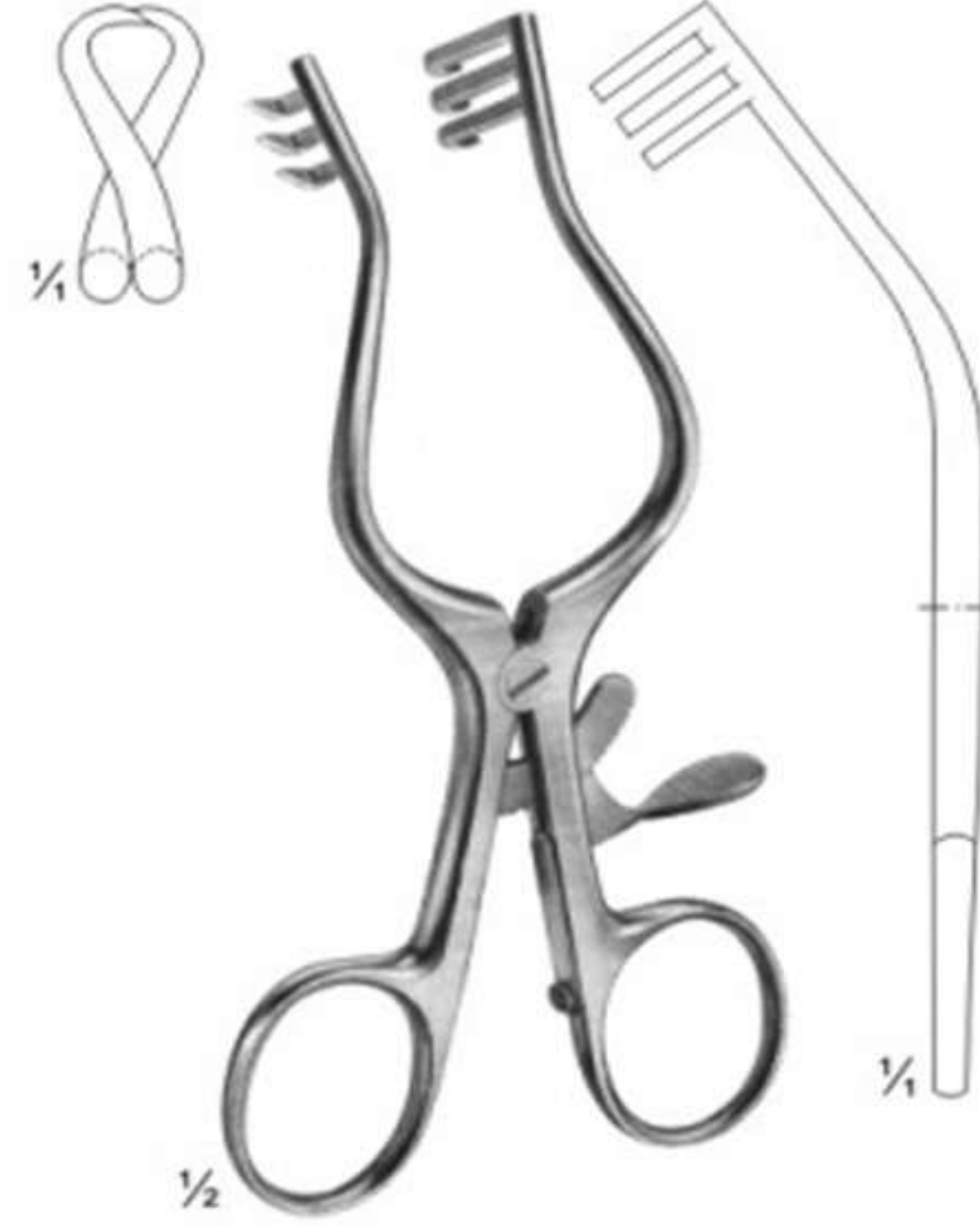

DMI-1-2002
WULLSTEINsharp130 mm

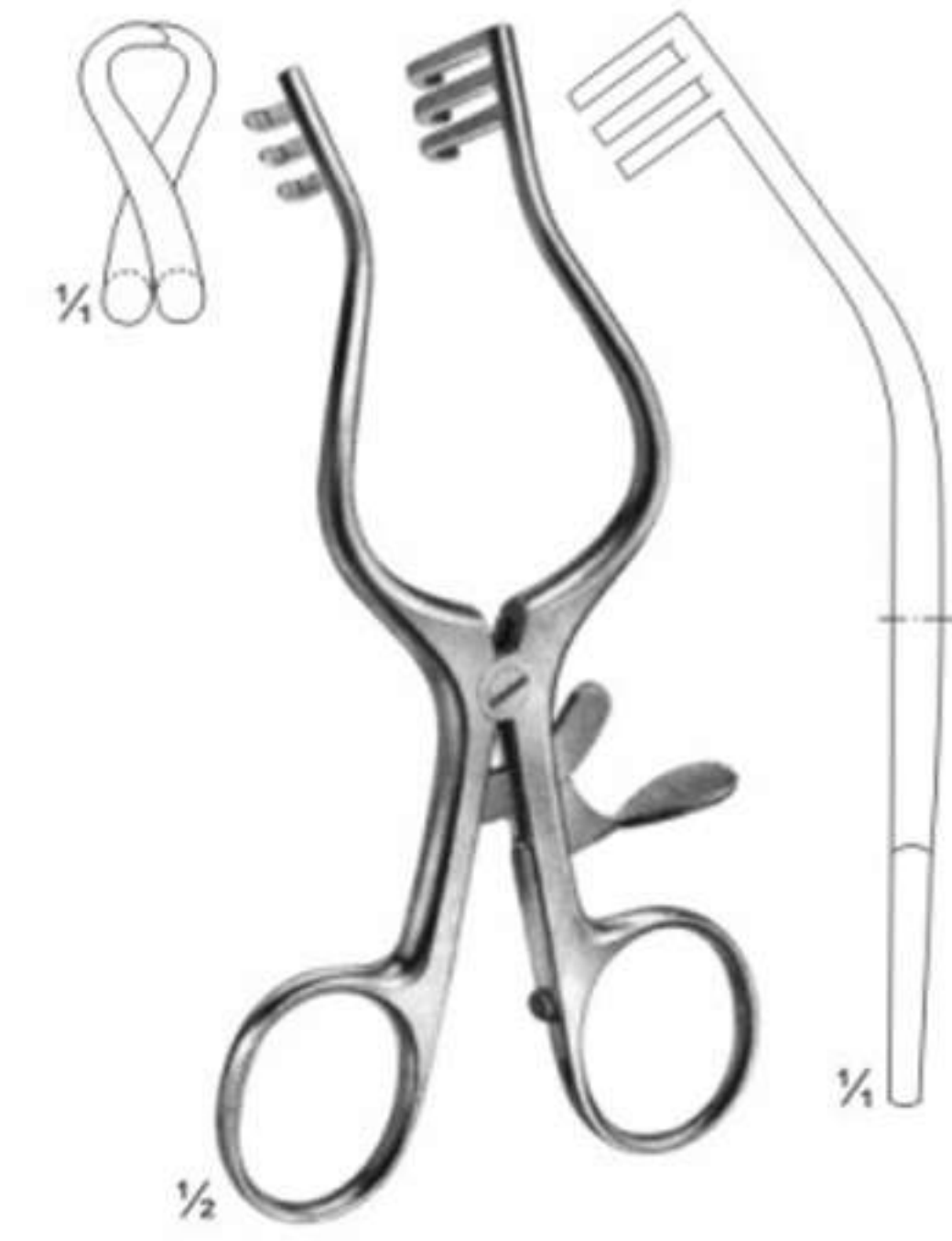

DMI-1-2003
WULLSTEINblunt130 mm



DMI-1-2004
WEITLANERsharp165 mm



DMI-1-2005
PLESTER blunt110 mm

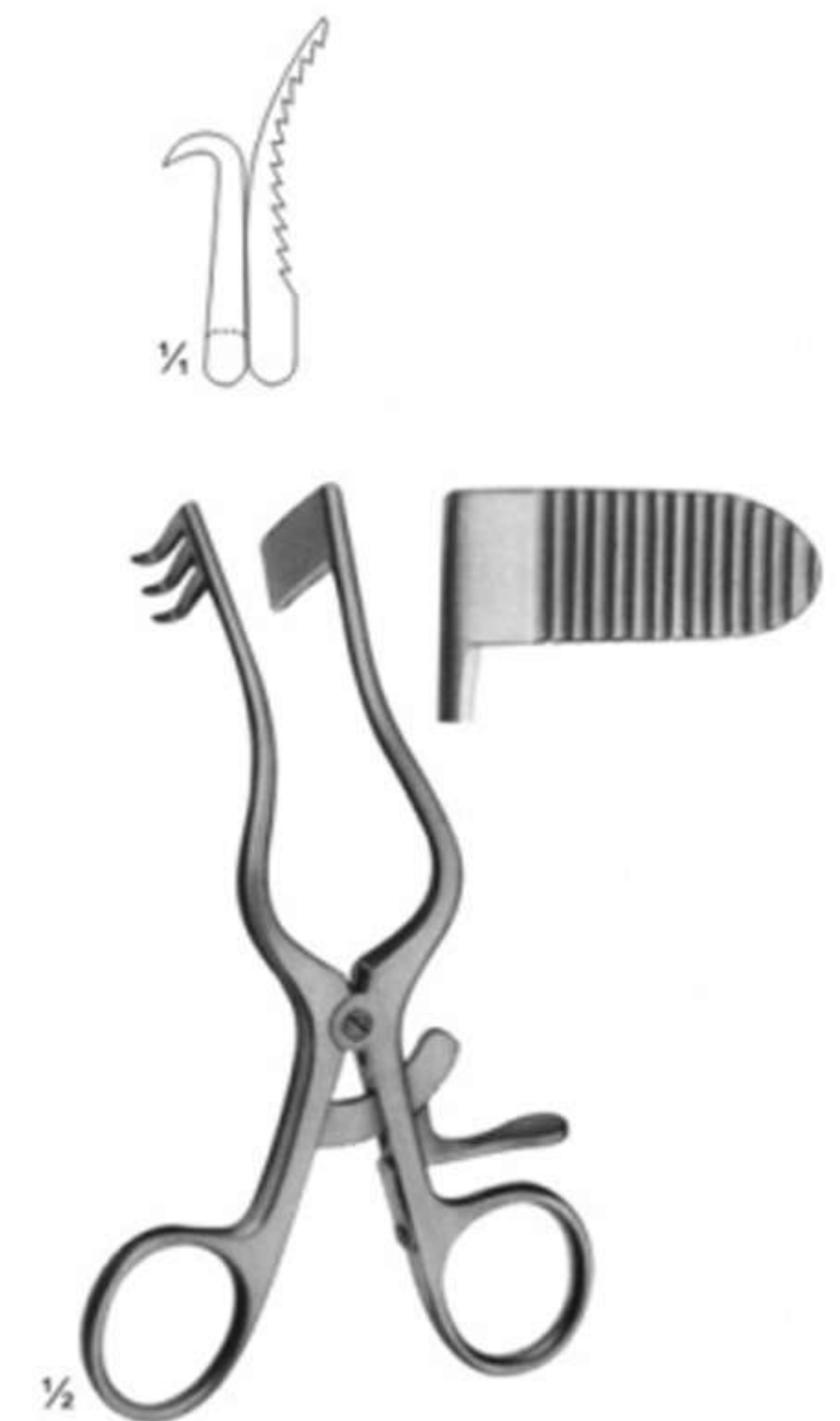

DMI-1-2006
PERKINS130 mm

**Self Retaining Retractors,
Abdominal Retractors**



DMI-1-2007
JOLL (FRIEDMAN) Thyroid- and
vaginal retractor 155 mm Self Retaining
Retractors, Abdominal Retractors

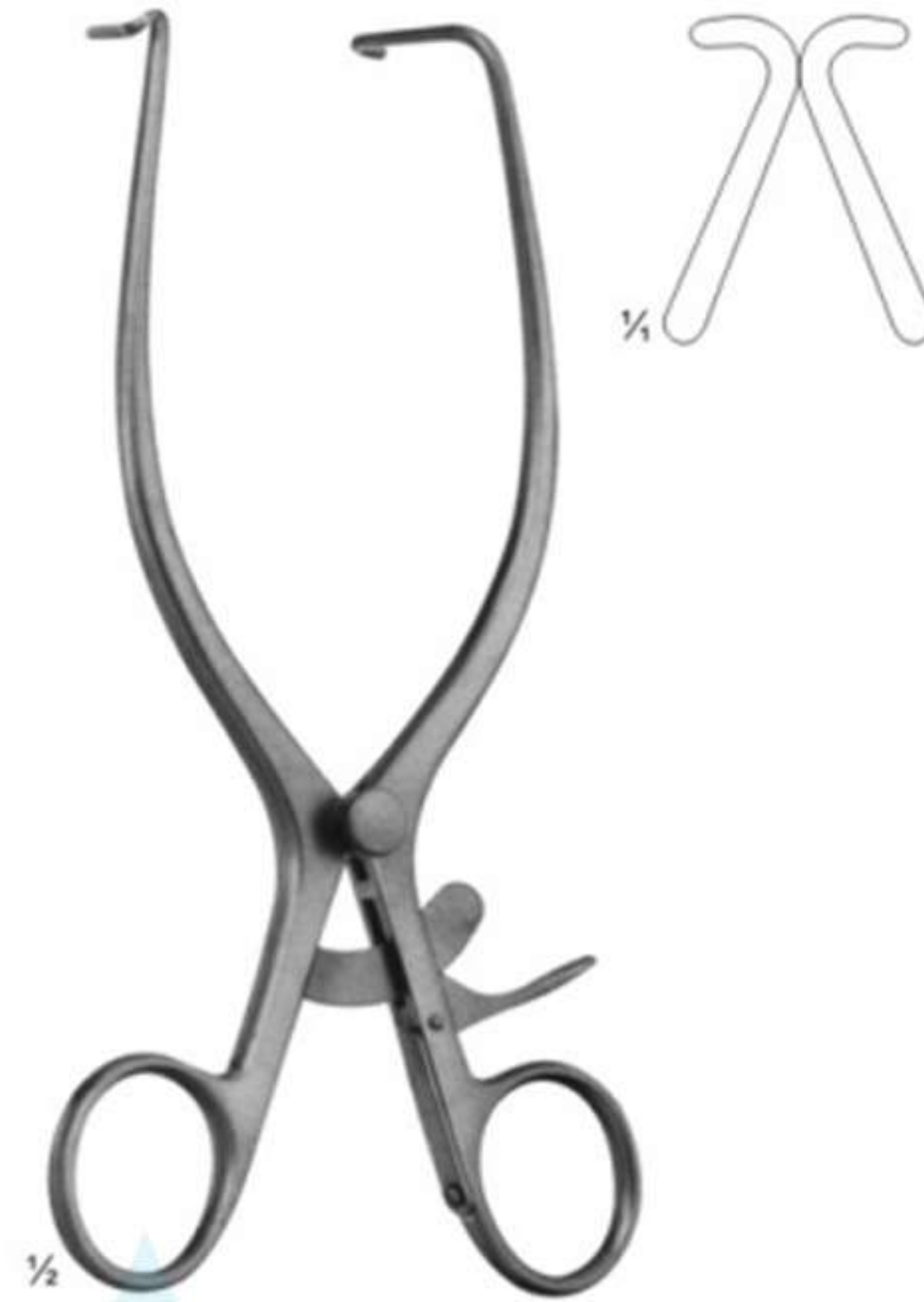

DMI-1-2008
JACKSON BURROWS Retractor,
blunt 185 mm



DMI-1-2009
GELPI Vaginal retractor 135 mm



DMI-1-2010
GELPI Skin- and vaginal
retractor 175 mm



DMI-1-2011
GELPI Skin- and vaginal retractor 175 mm



DMI-1-2012
DE BAKEY Femur retractor 145 mm

Self Retaining Retractors, Abdominal Retractors



DMI-1-2013
CLOWARD 135 mm



DMI-1-2014
INGE 170 mm

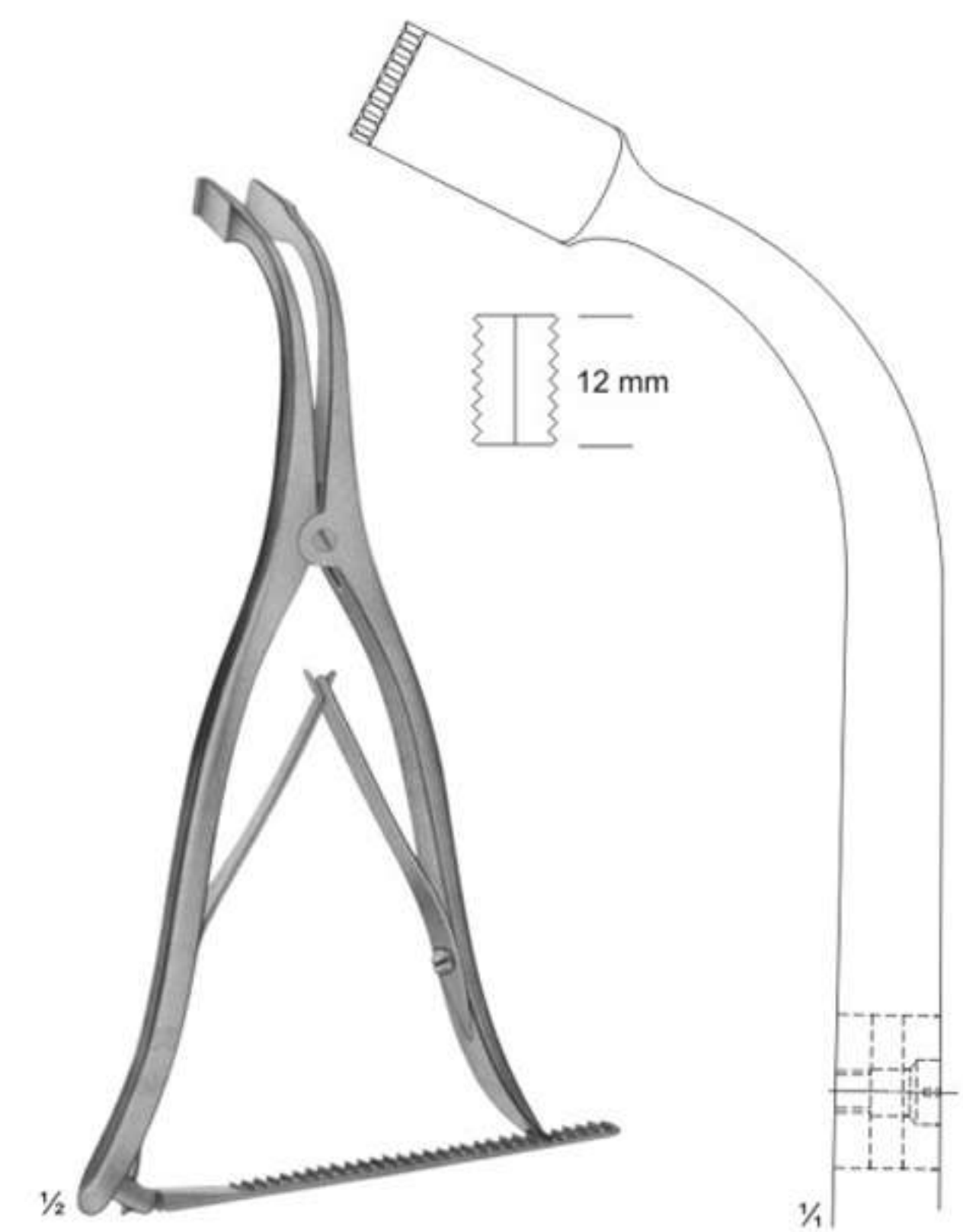

DMI-1-2015
INGE 275 mm



DMI-1-2016
GOSSET Blades: 38 mm deep

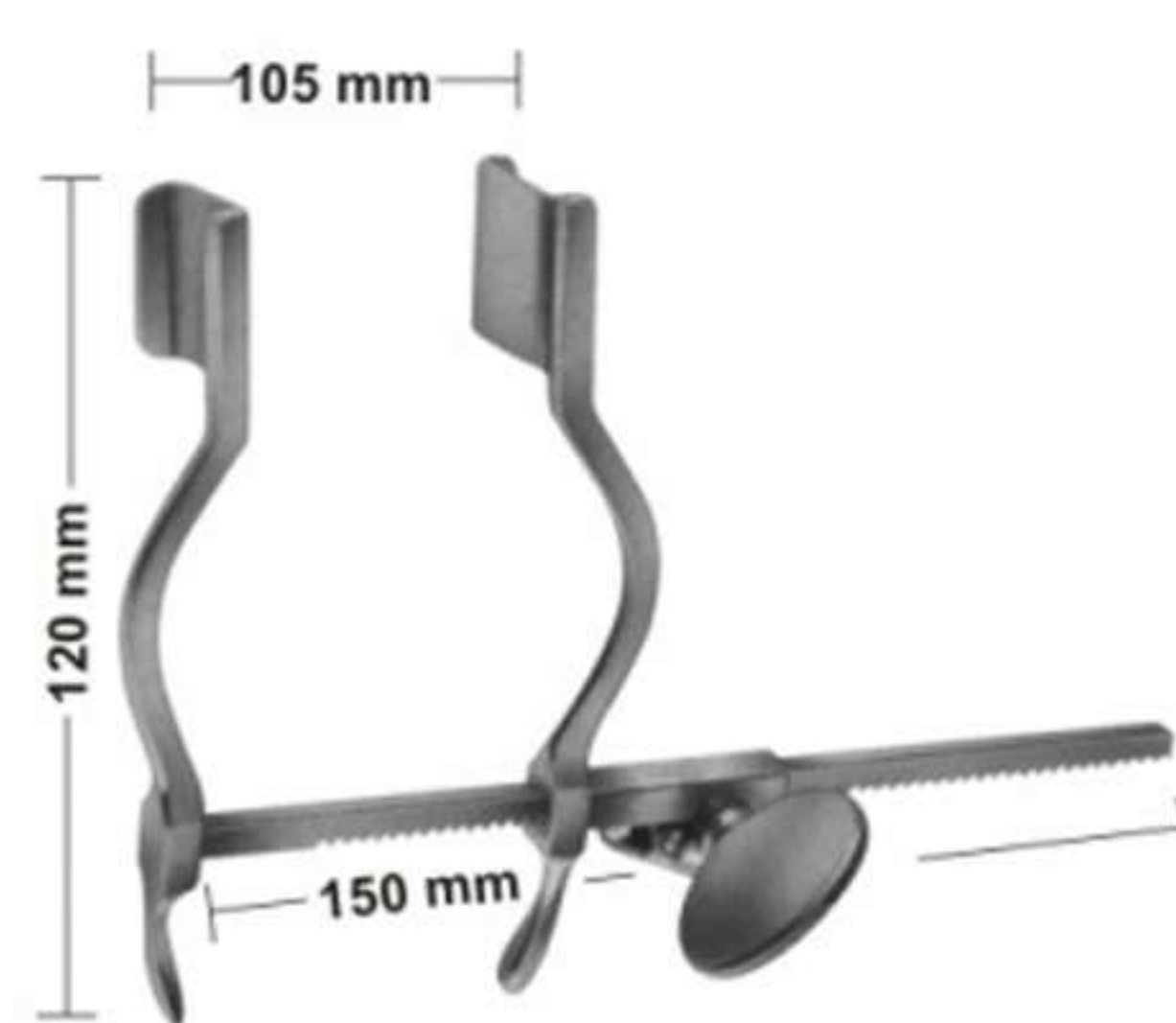

DMI-1-2017
HERTZLER Blades 20 X 25 mm

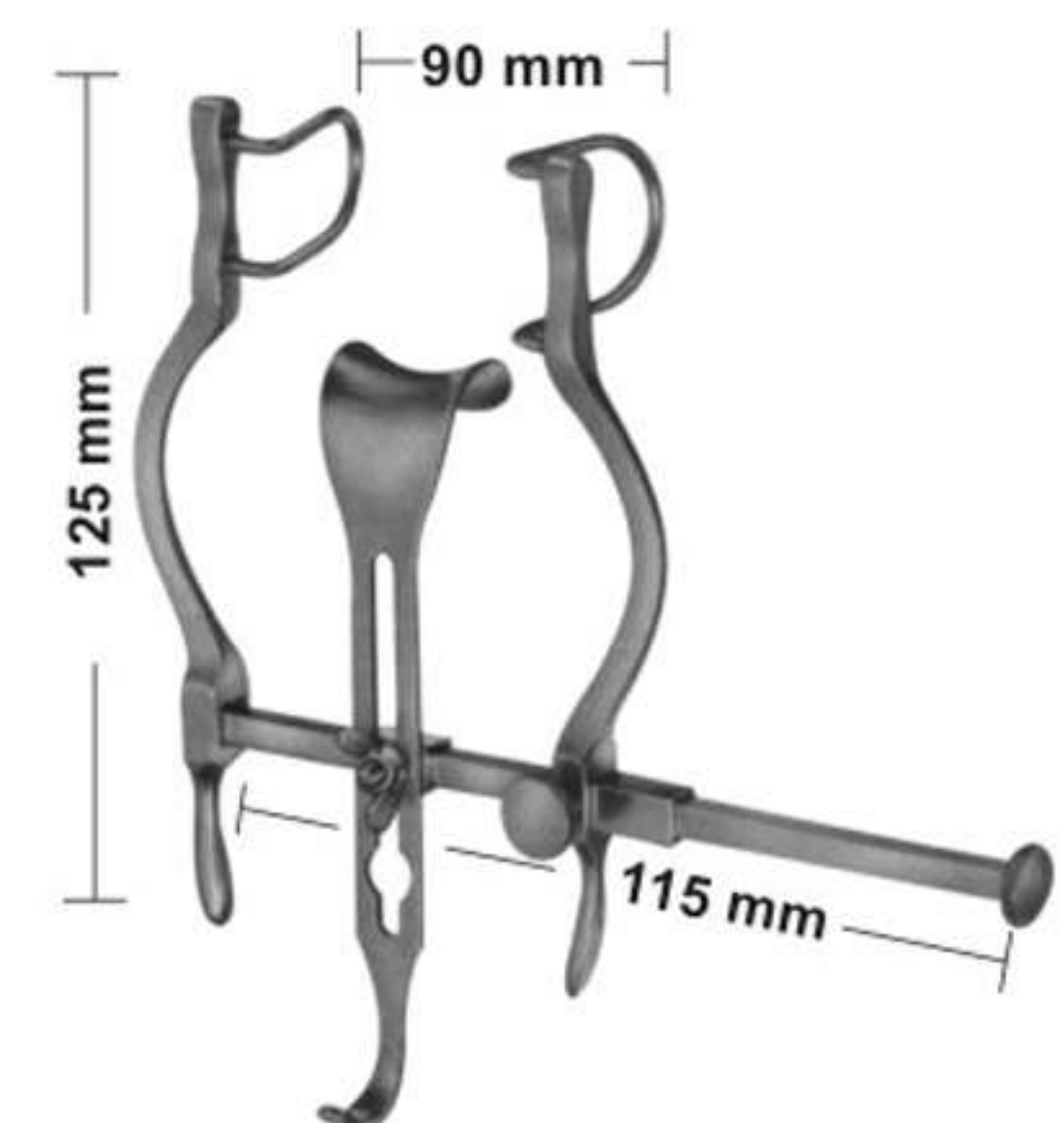

DMI-1-2018
BALFOUR-BABY Lateral blades 27 mm deep
Center blade 21x24 mm

**Self Retaining Retractors,
Abdominal Retractors**

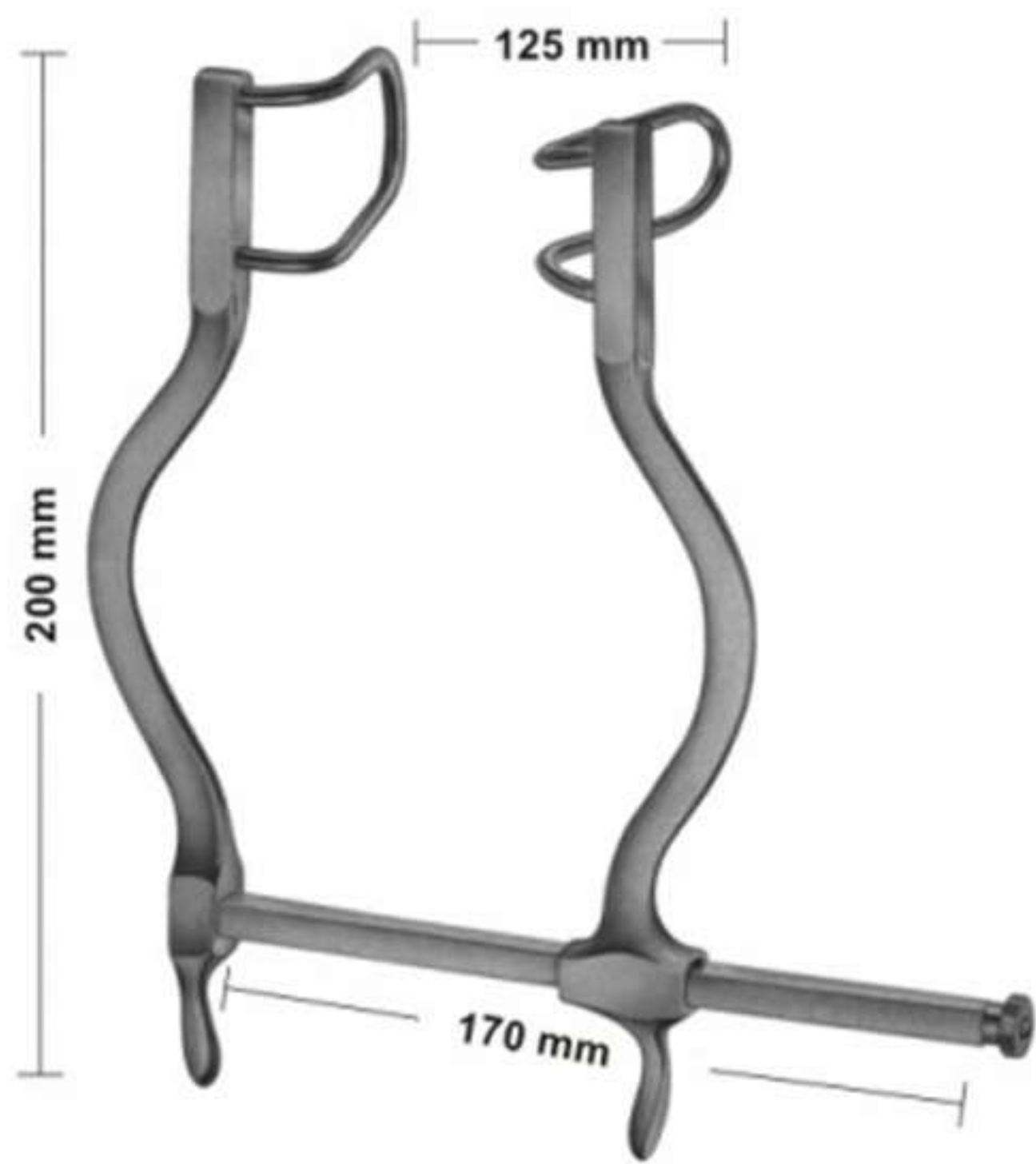

DMI-1-2019
GOSSET Blades: 55 mm deep

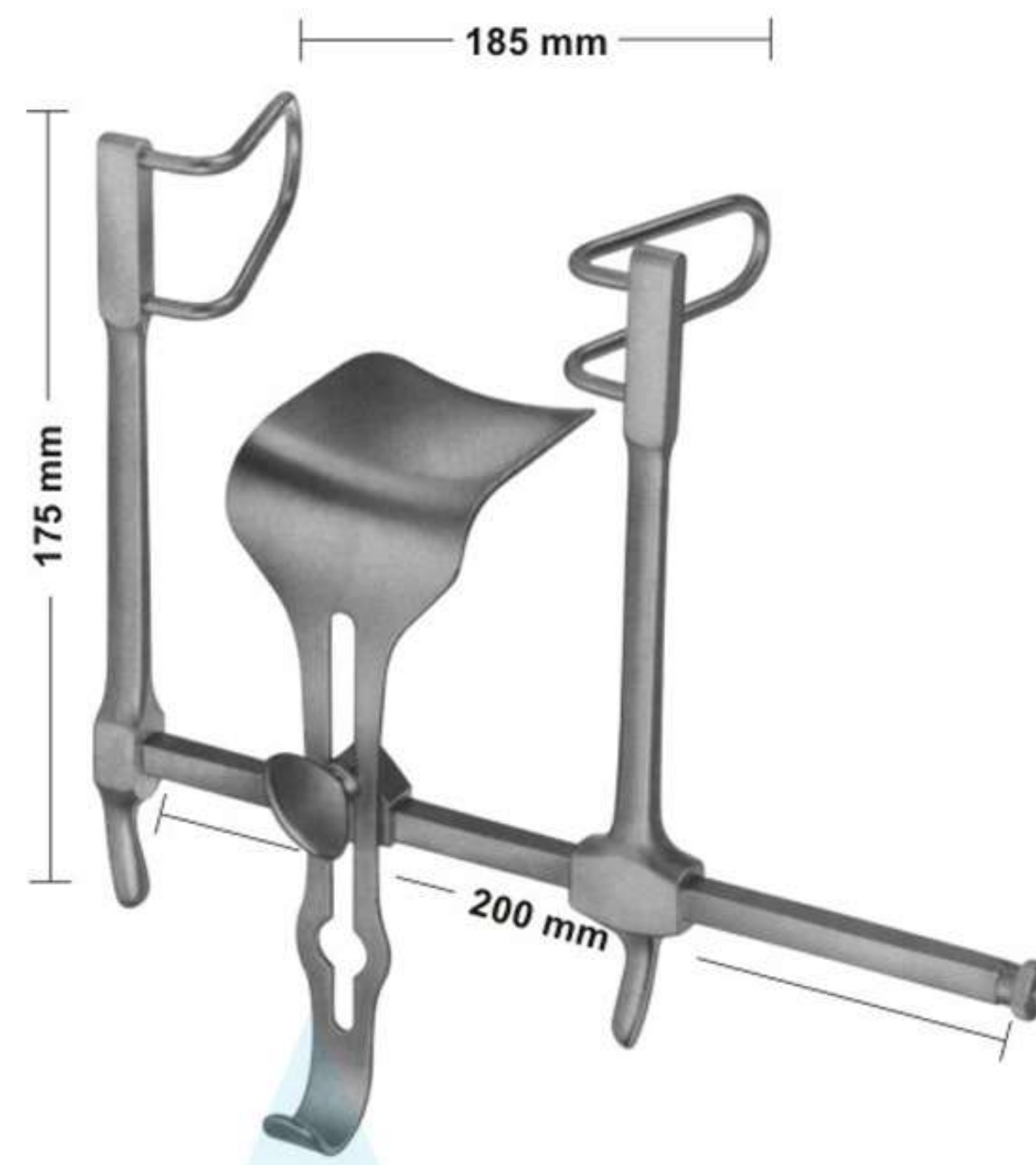

DMI-1-2020
GOSSET Lateral blades 58 mm deep
Center blade 59 x 57 mm

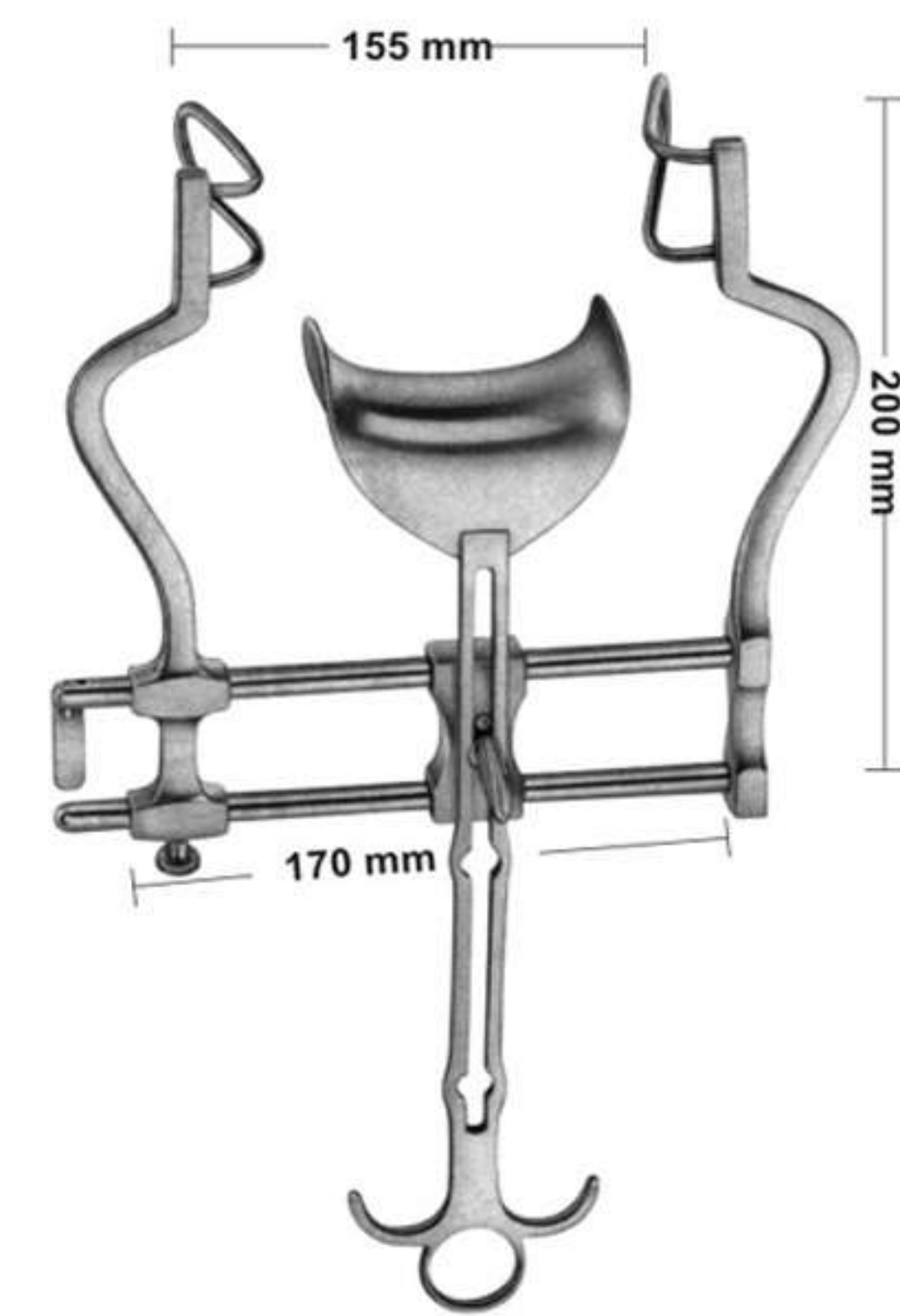

DMI-1-2021
BALFOUR Lateral blades 60 mm deep
Center blade 47 x 80 mm

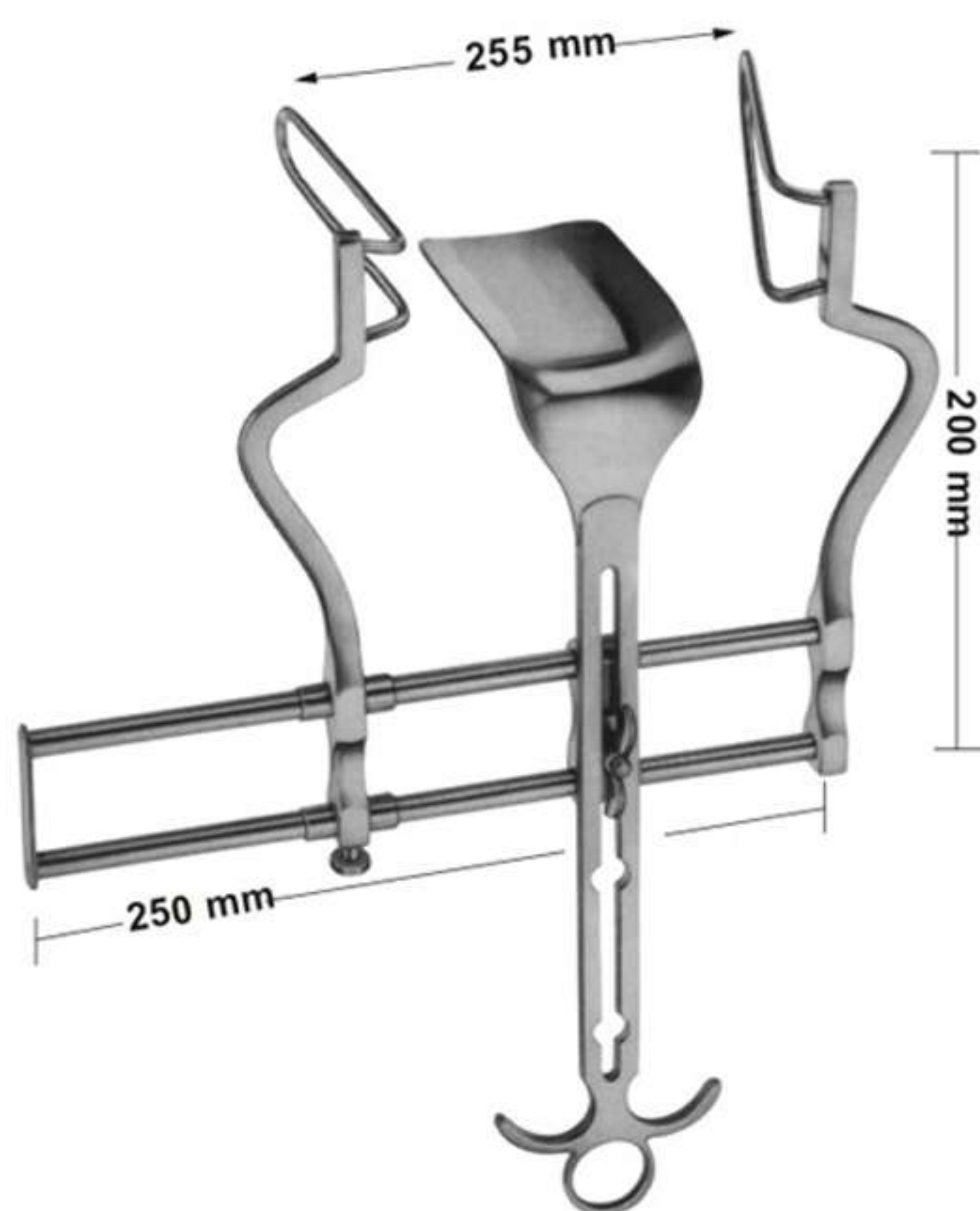

DMI-1-2022
GOSSET Blades: 38 mm deep



DMI-1-2023
Center blade only 54 x 80 mm

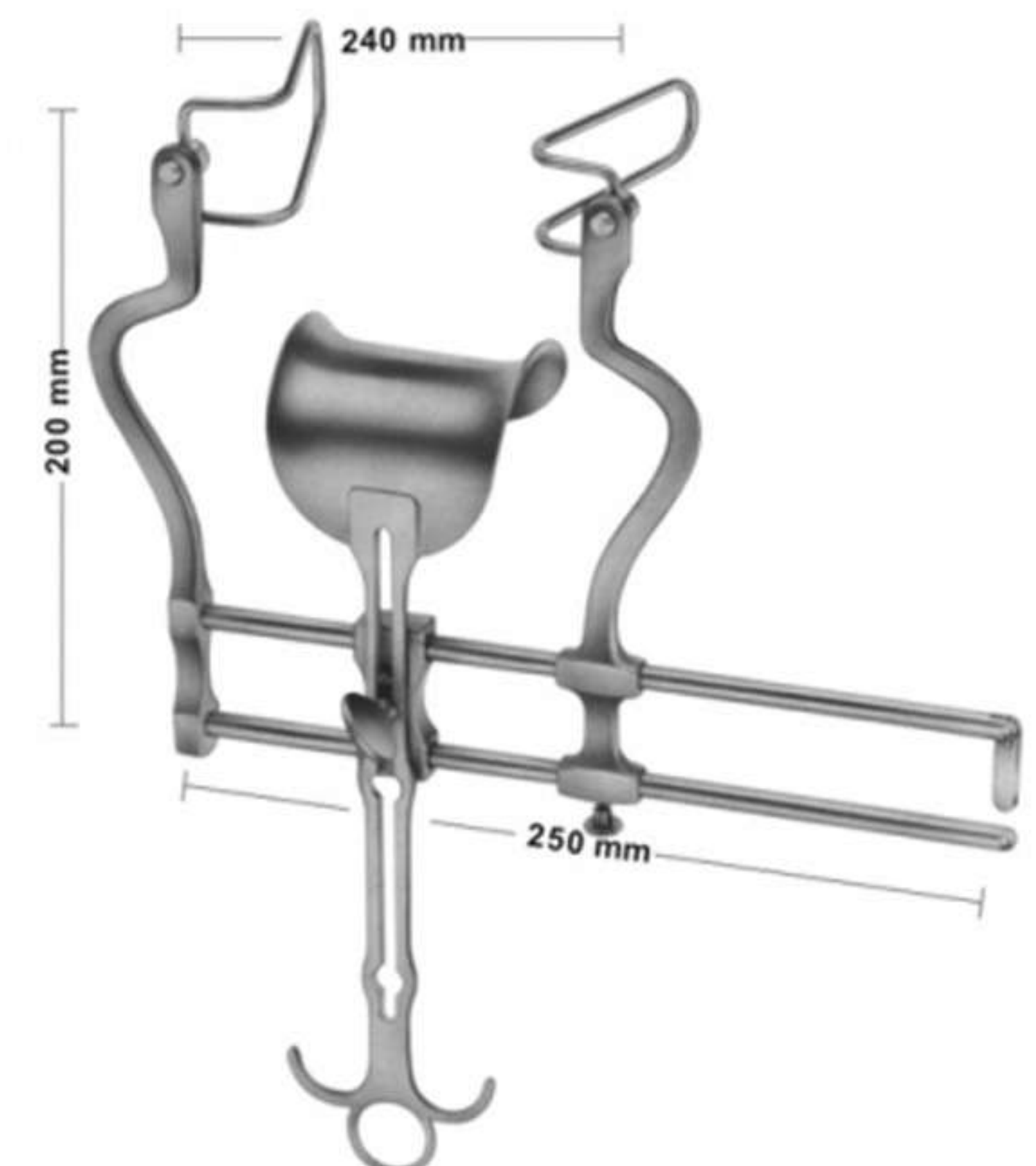

DMI-1-2024
BALFOUR Complete Spreader only
Lateral blades Center blade

**Self Retaining Retractors,
Abdominal Retractors**

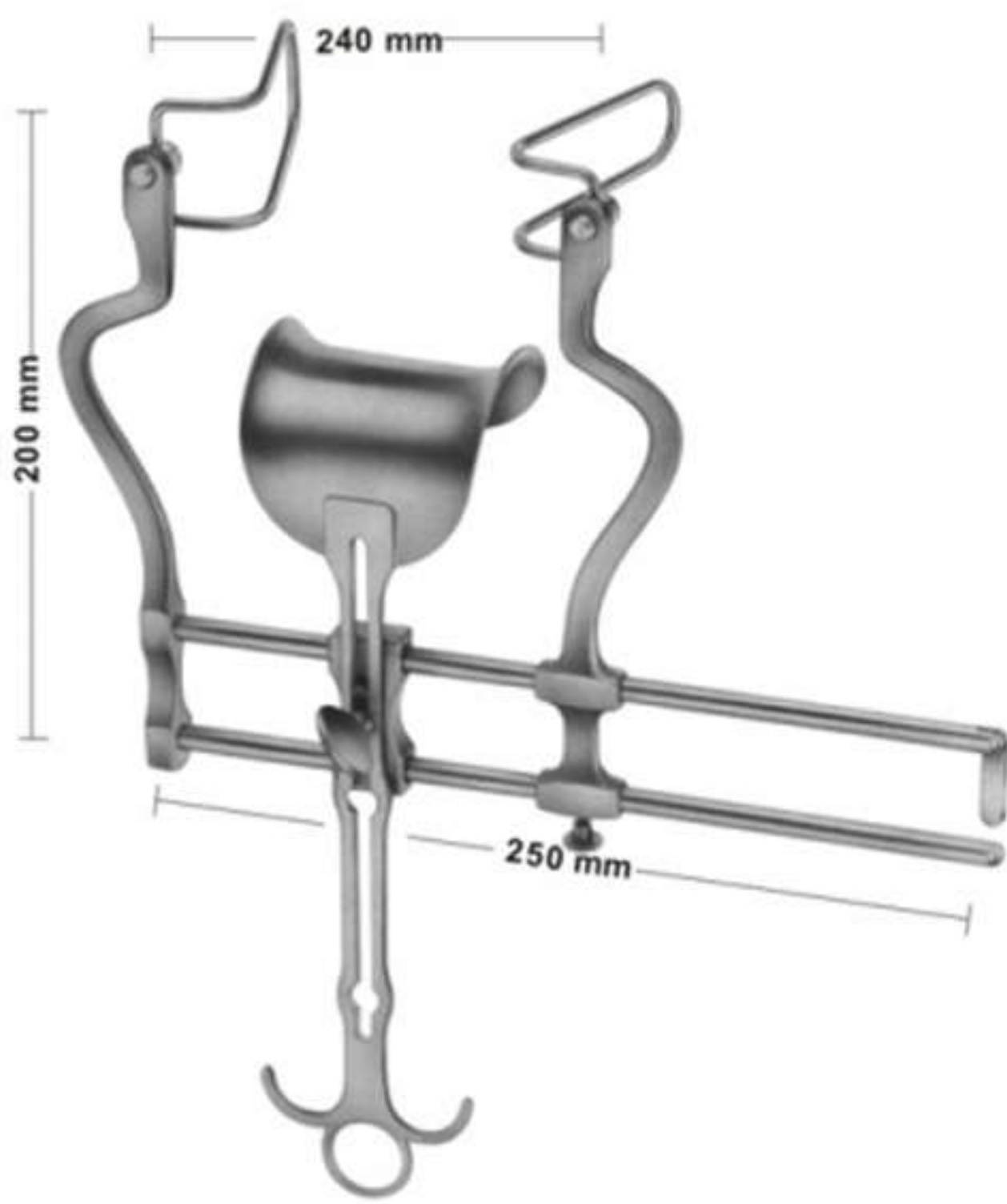

DMI-1-2025
BALFOUR Complete Spreader
onlyLateral bladesCenter blade

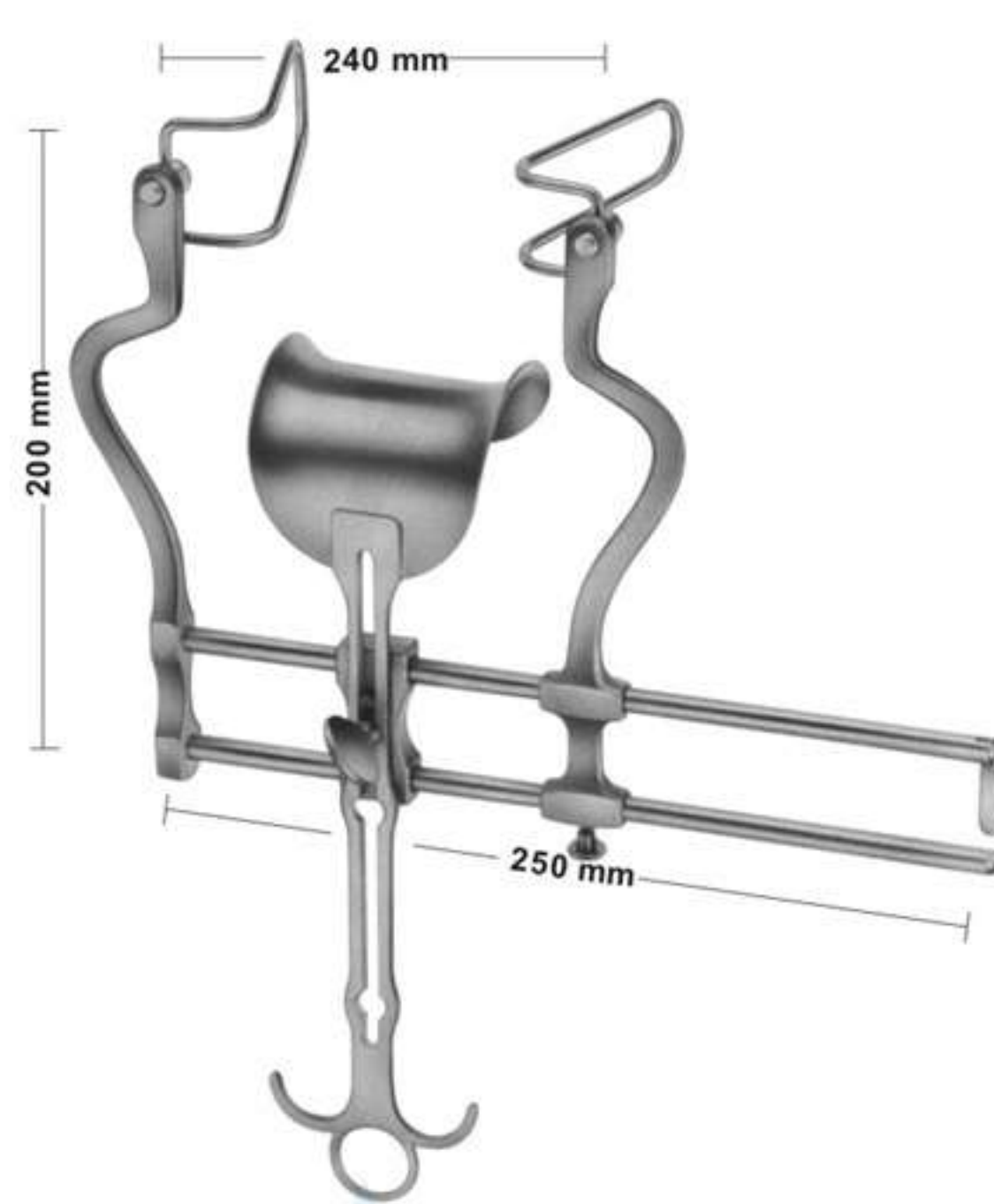

DMI-1-2026
BALFOUR Complete Spreader
onlyLateral bladesCenter blade

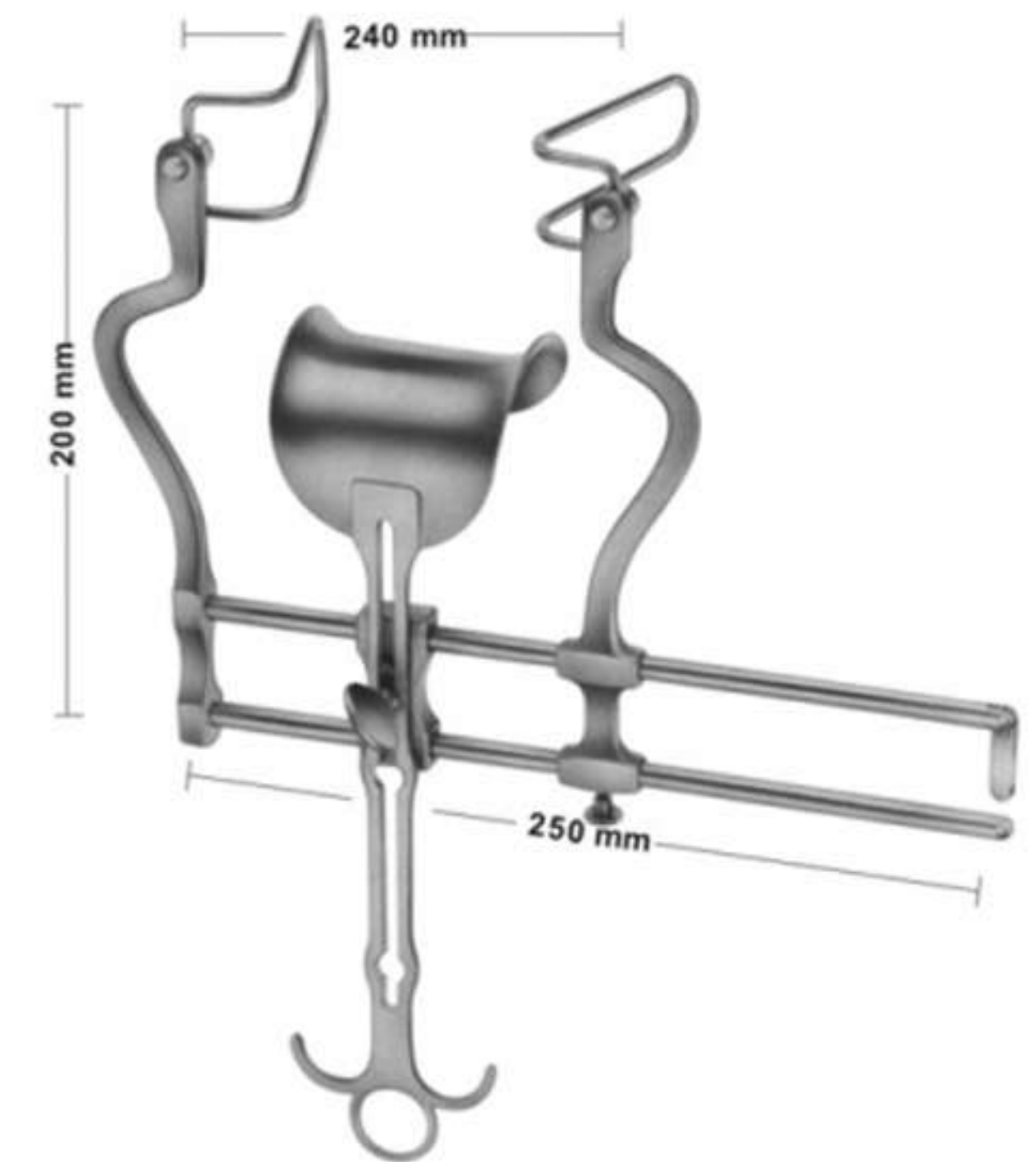

DMI-1-2027
BALFOUR Complete Spreader
onlyLateral bladesCenter blade

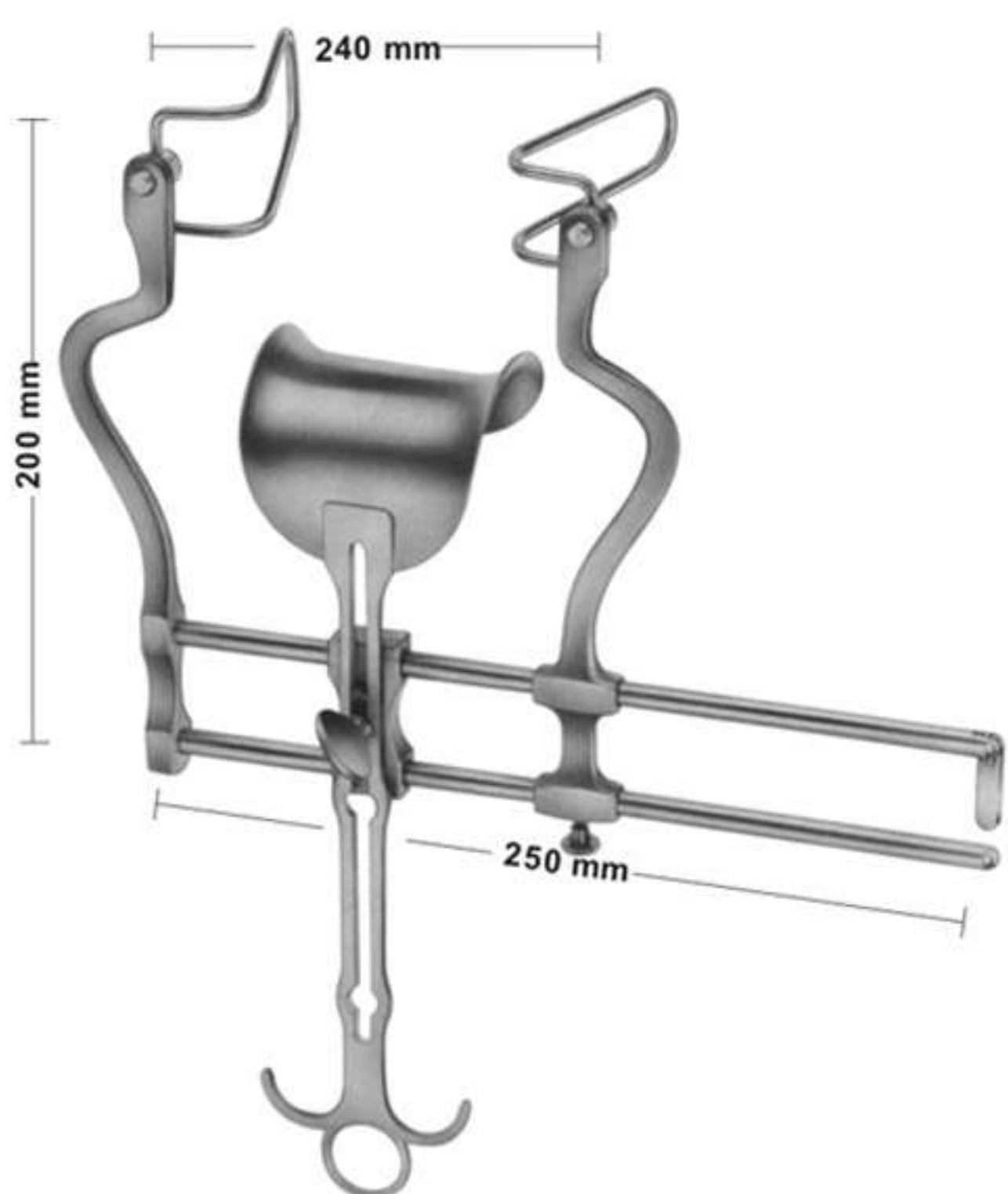

DMI-1-2028
BALFOUR Complete Spreader
onlyLateral bladesCenter blade

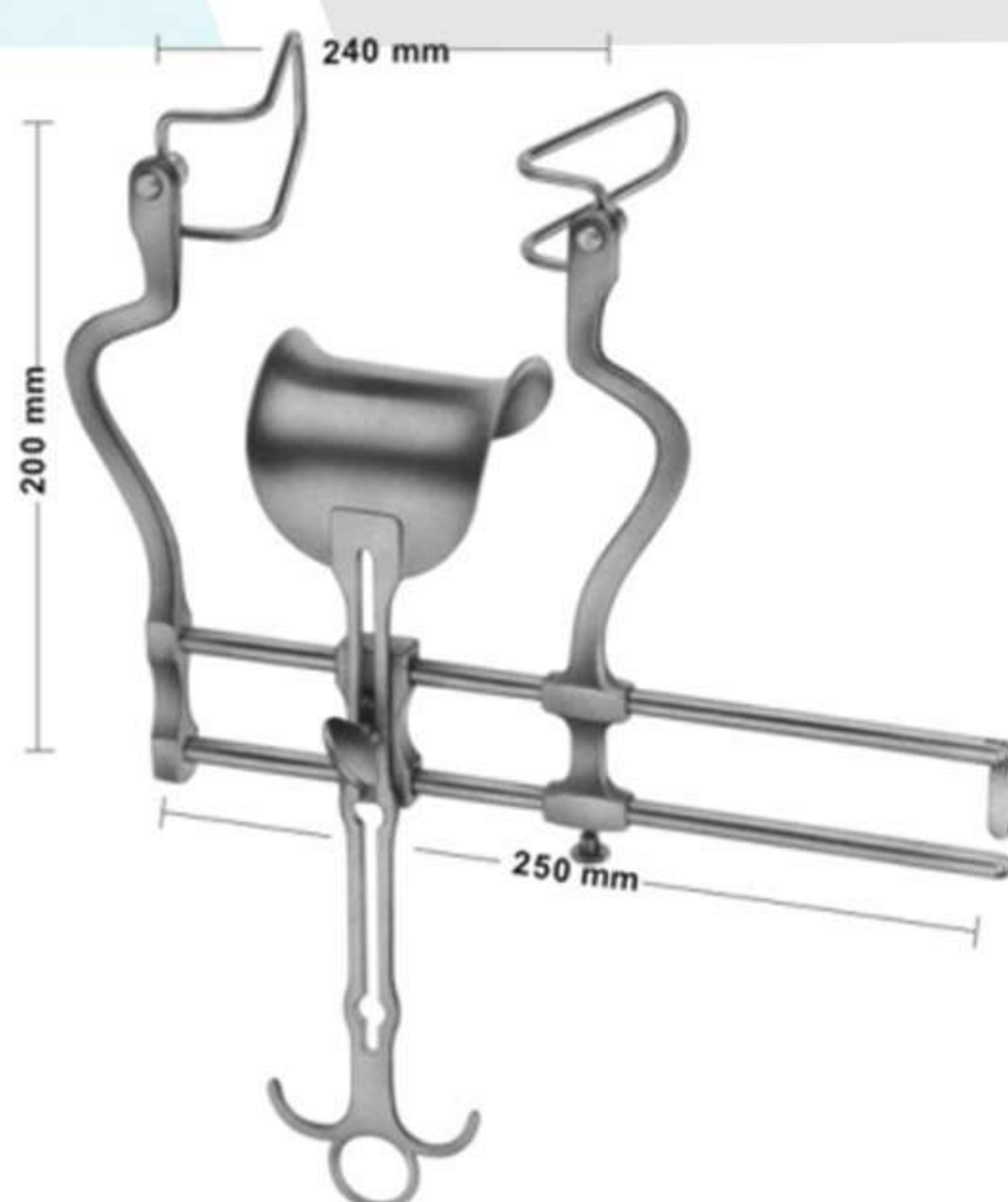

DMI-1-2029
BALFOUR Complete Spreader
onlyLateral bladesCenter blade

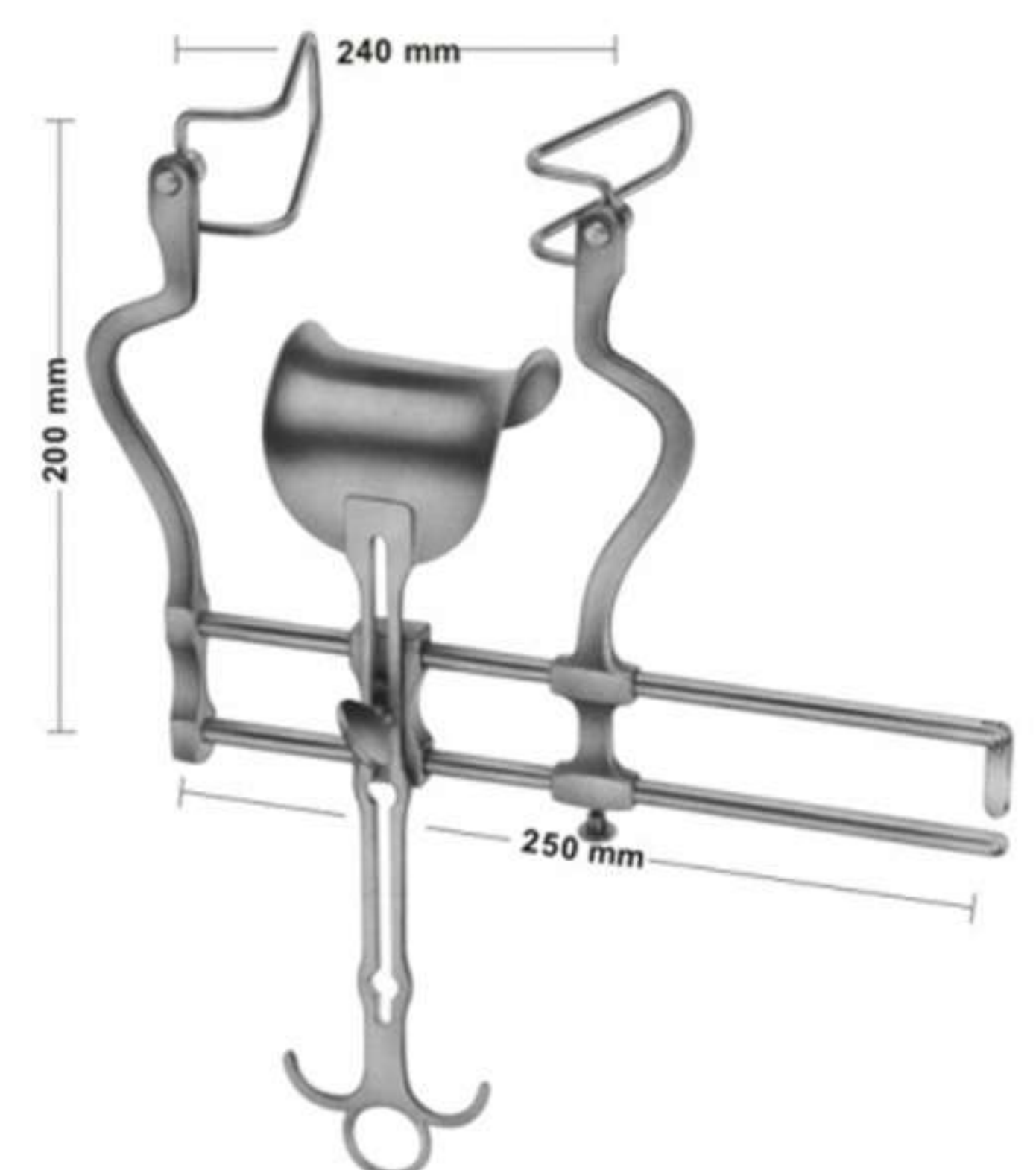

DMI-1-2030
BALFOUR Complete Spreader
onlyLateral bladesCenter blade

Self Retaining Retractors, Abdominal Retractors

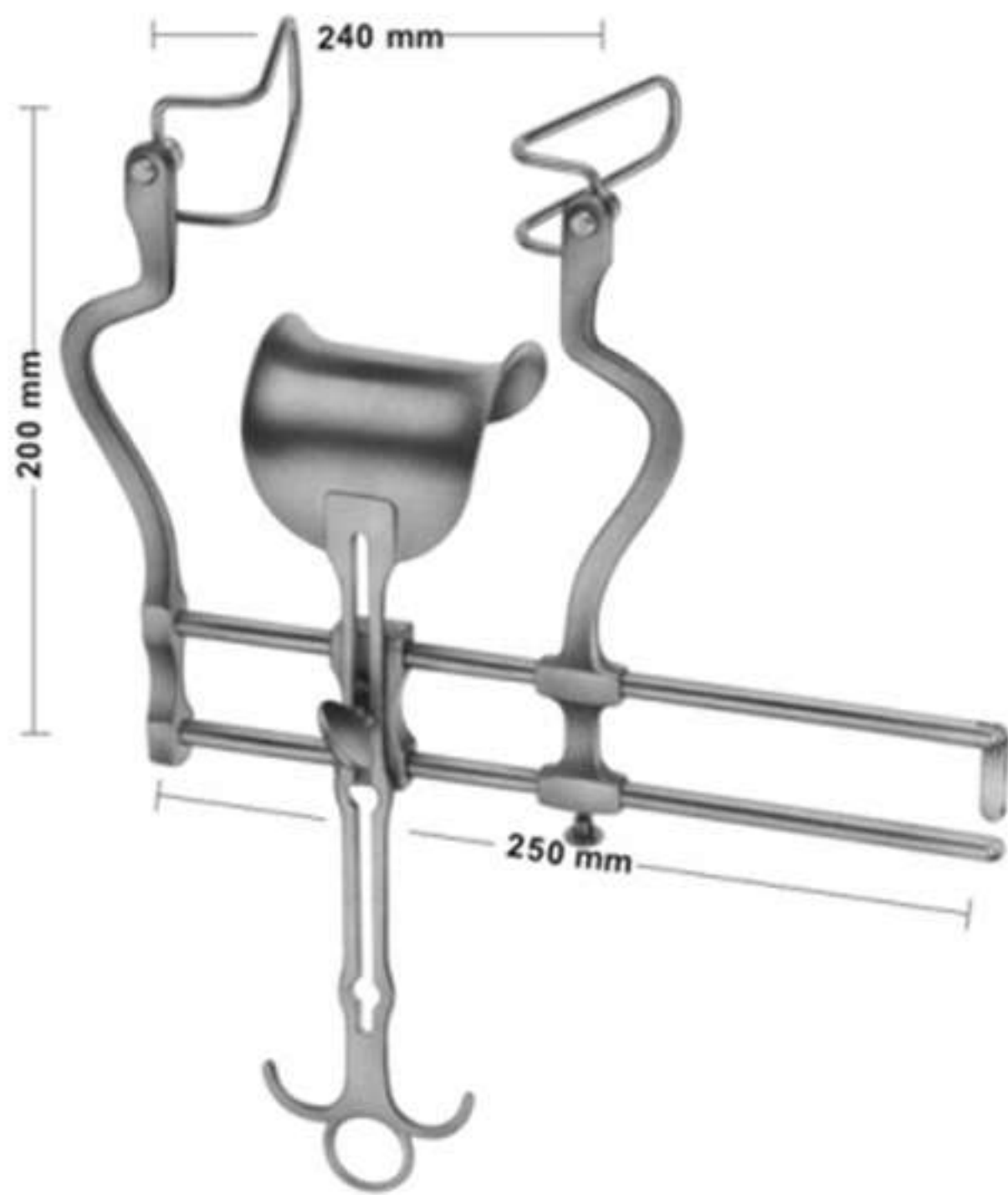

DMI-1-2031
BALFOUR Complete Spreader
onlyLateral bladesCenter blade

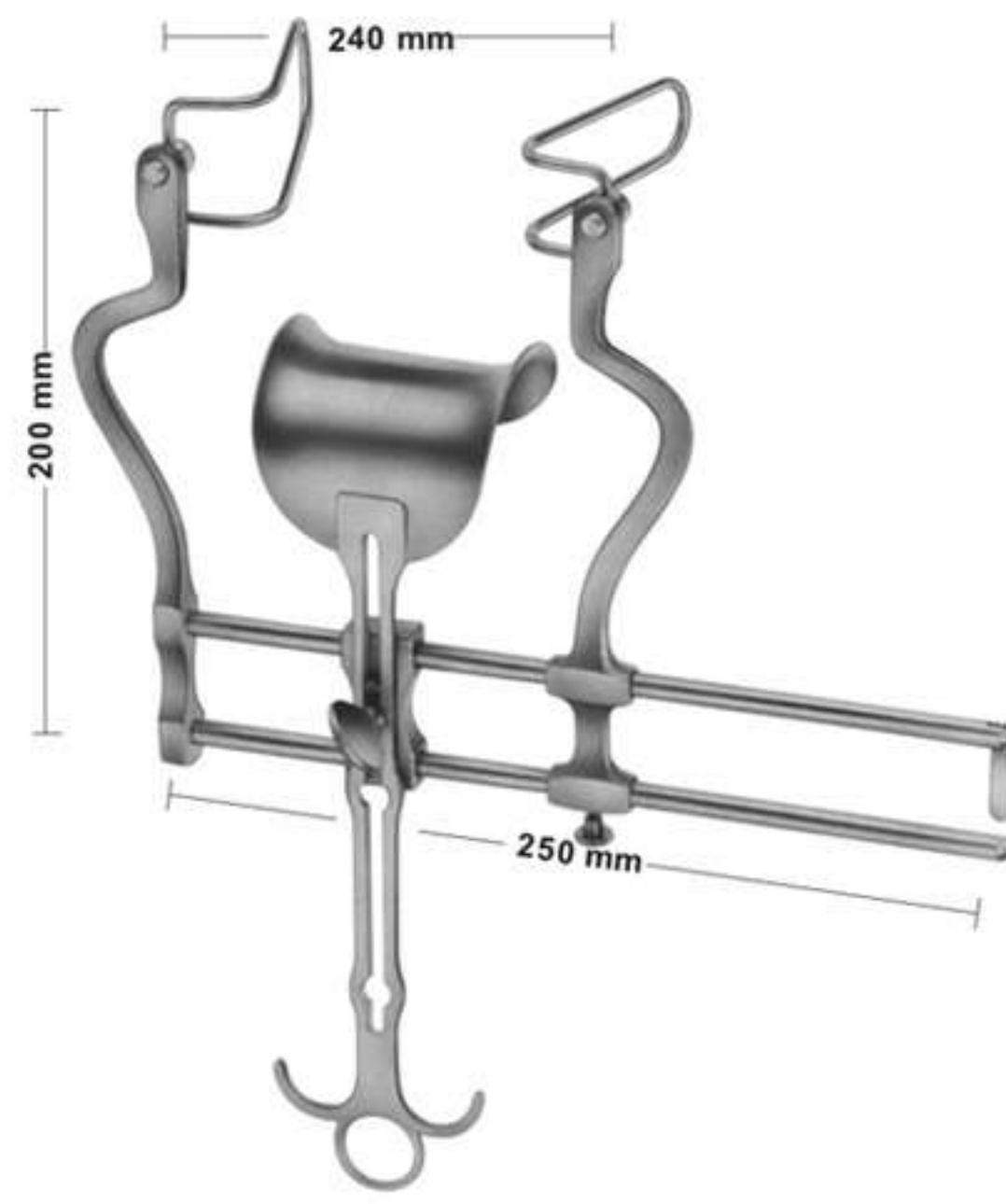

DMI-1-2032
BALFOUR Complete Spreader
onlyLateral bladesCenter blade

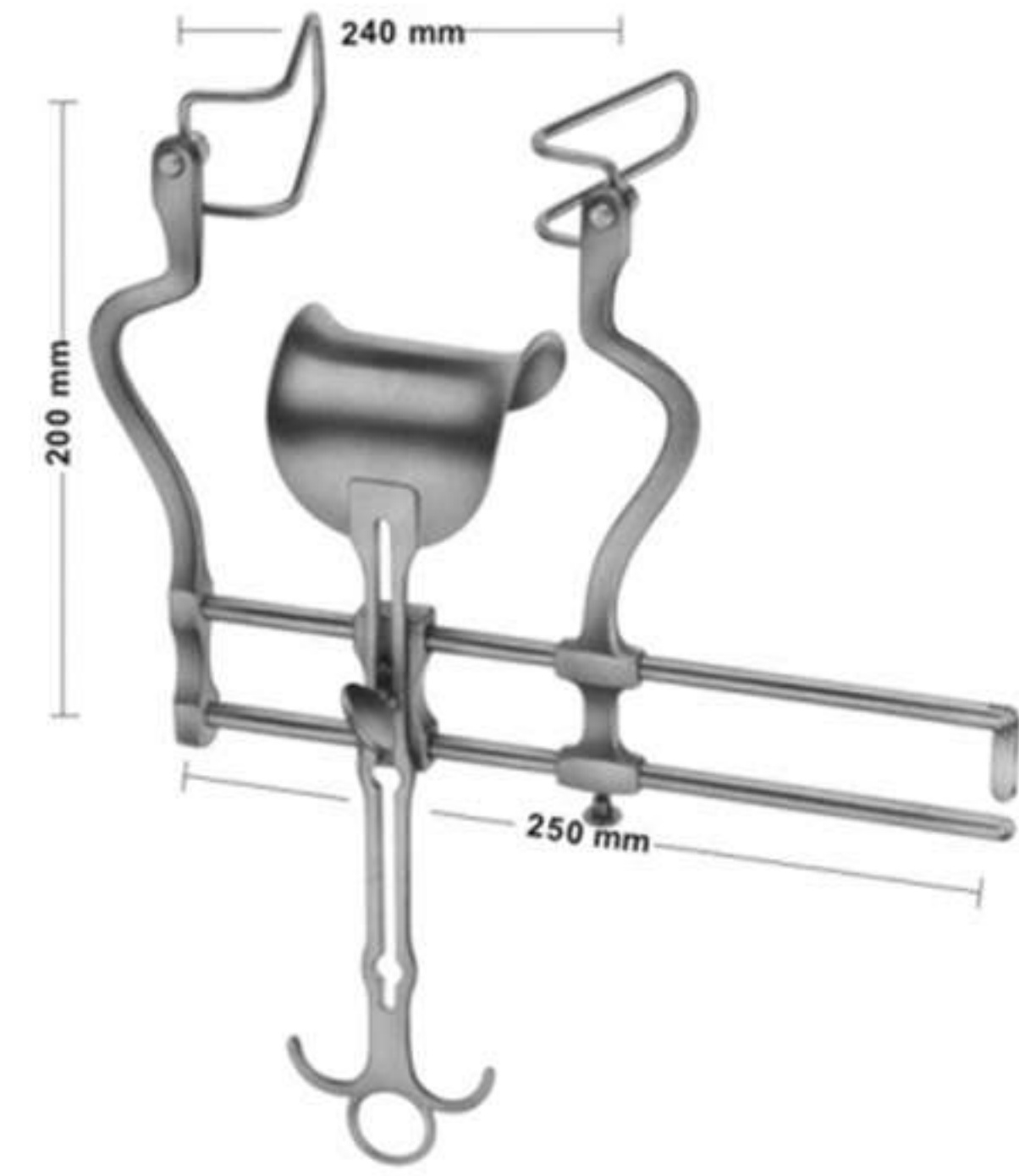

DMI-1-2033
BALFOUR Complete Spreader
onlyLateral bladesCenter blade

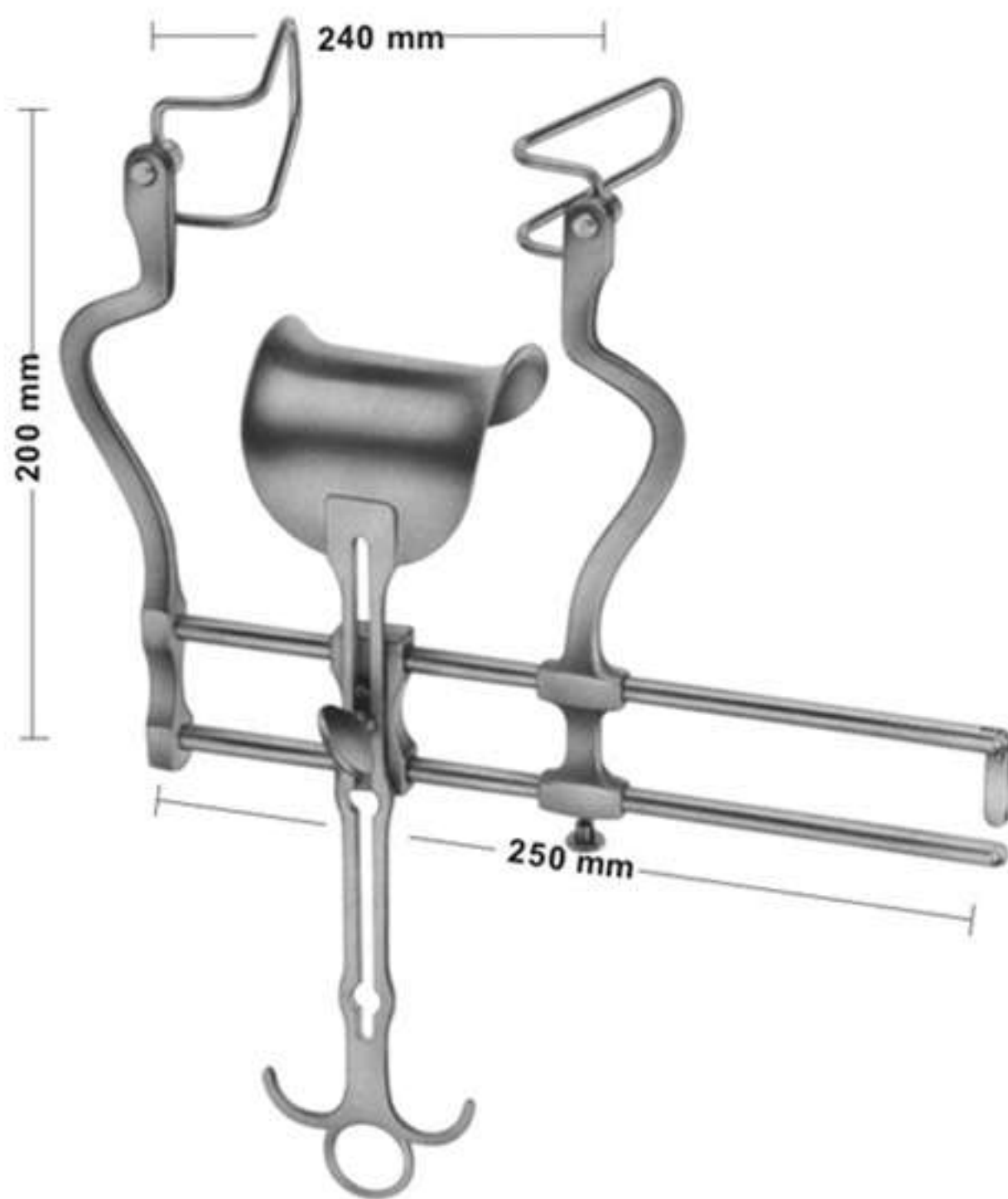

DMI-1-2033
BALFOUR Complete Spreader
onlyLateral bladesCenter blade

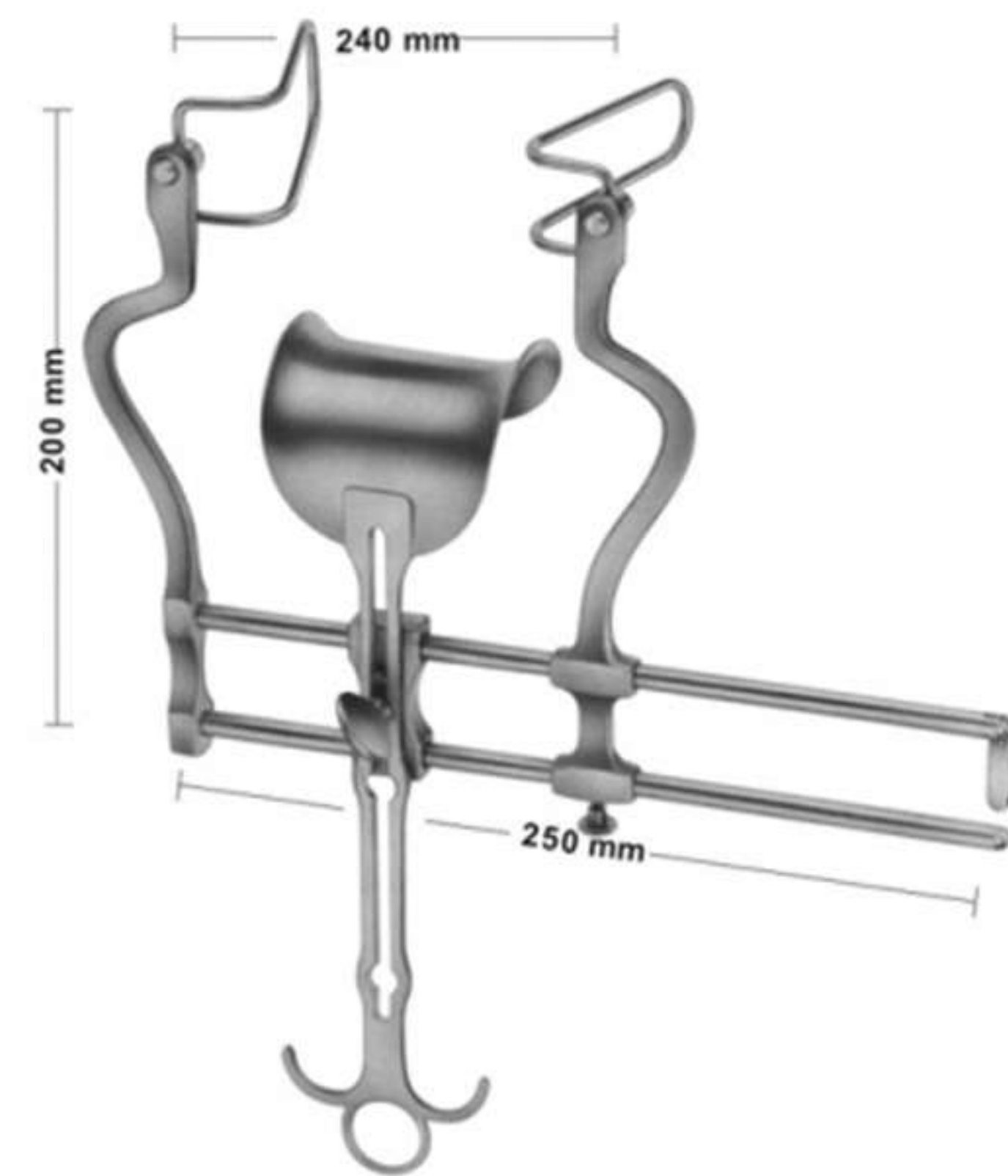

DMI-1-2034
BALFOUR Complete Spreader
onlyLateral bladesCenter blade

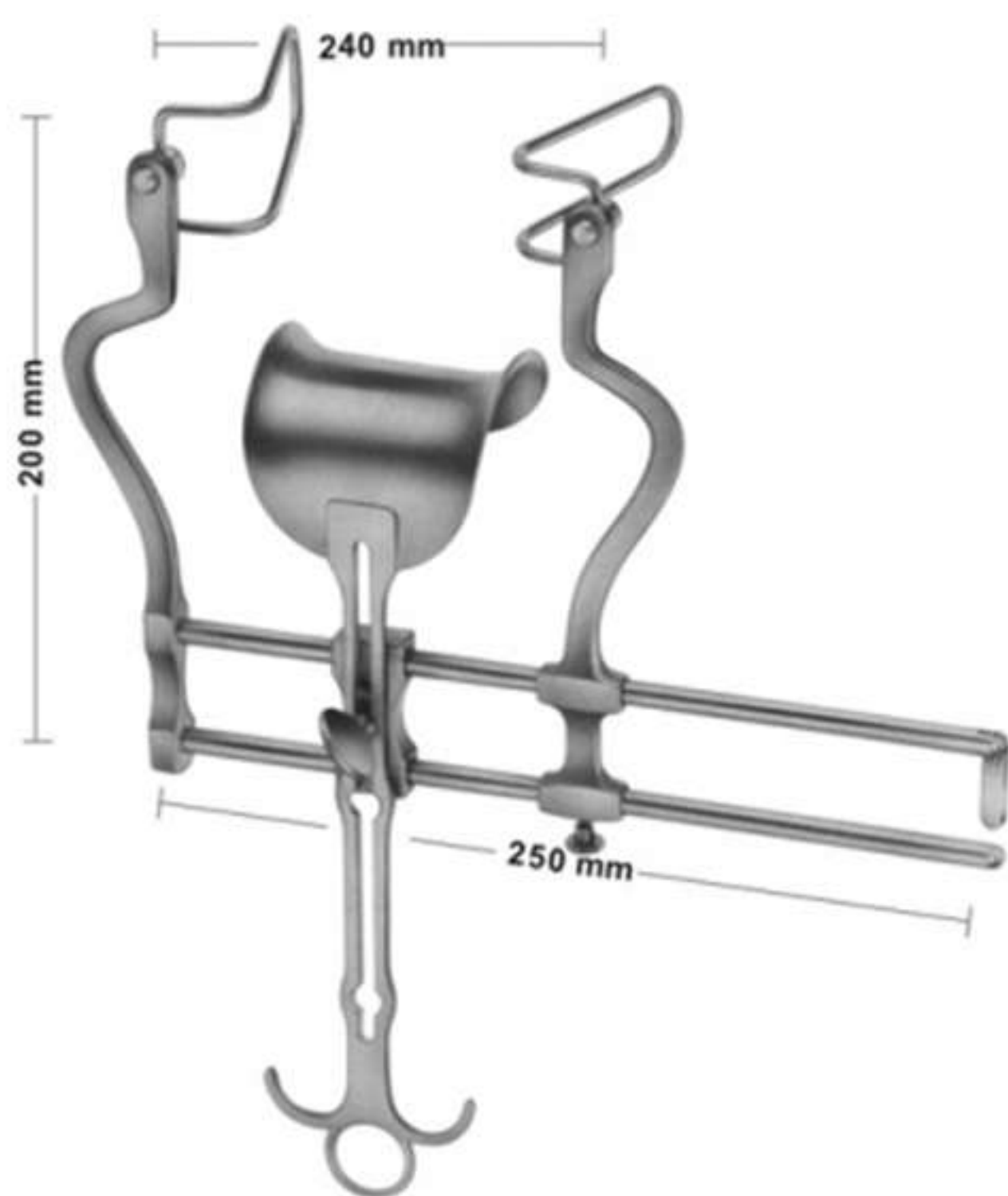

DMI-1-2035
BALFOUR Complete Spreader
onlyLateral bladesCenter blade



DMI-1-2036
BALFOUR Complete Spreader
onlyLateral bladesCenter blade

Abdominal Surgery Intestinal and Rectal Instruments

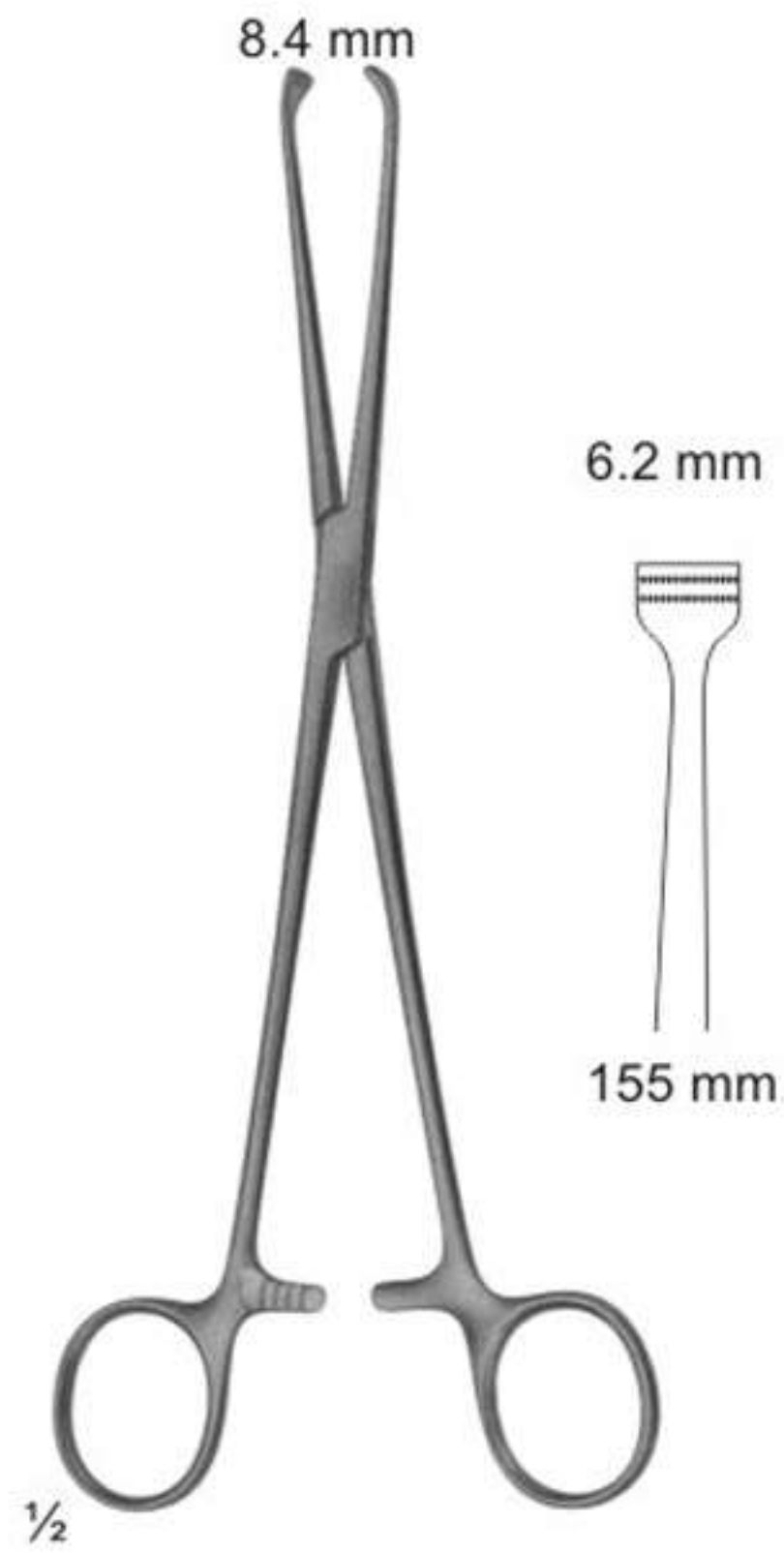

DMI-1-2101
ALLIS 155 mm

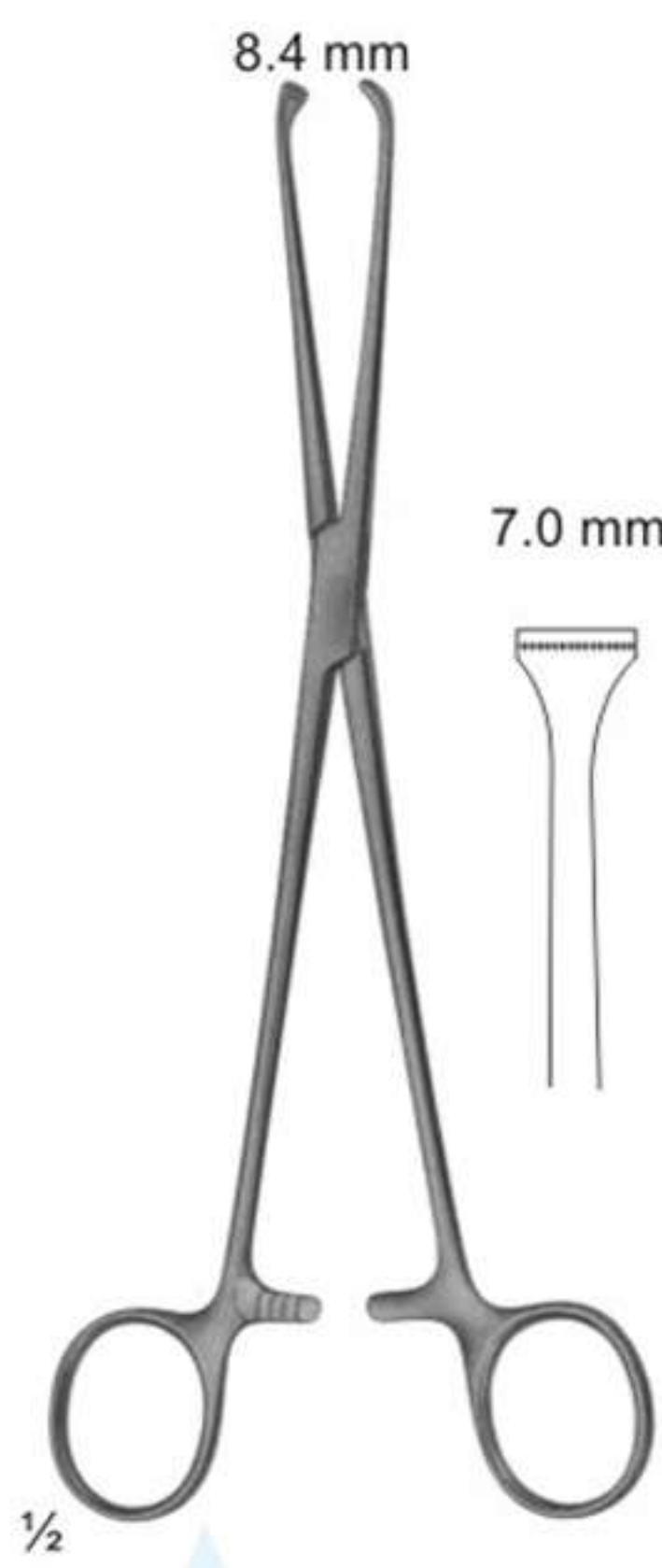

DMI-1-2102
ALLIS 200 mm



DMI-1-2103
ALLIS 220 mm

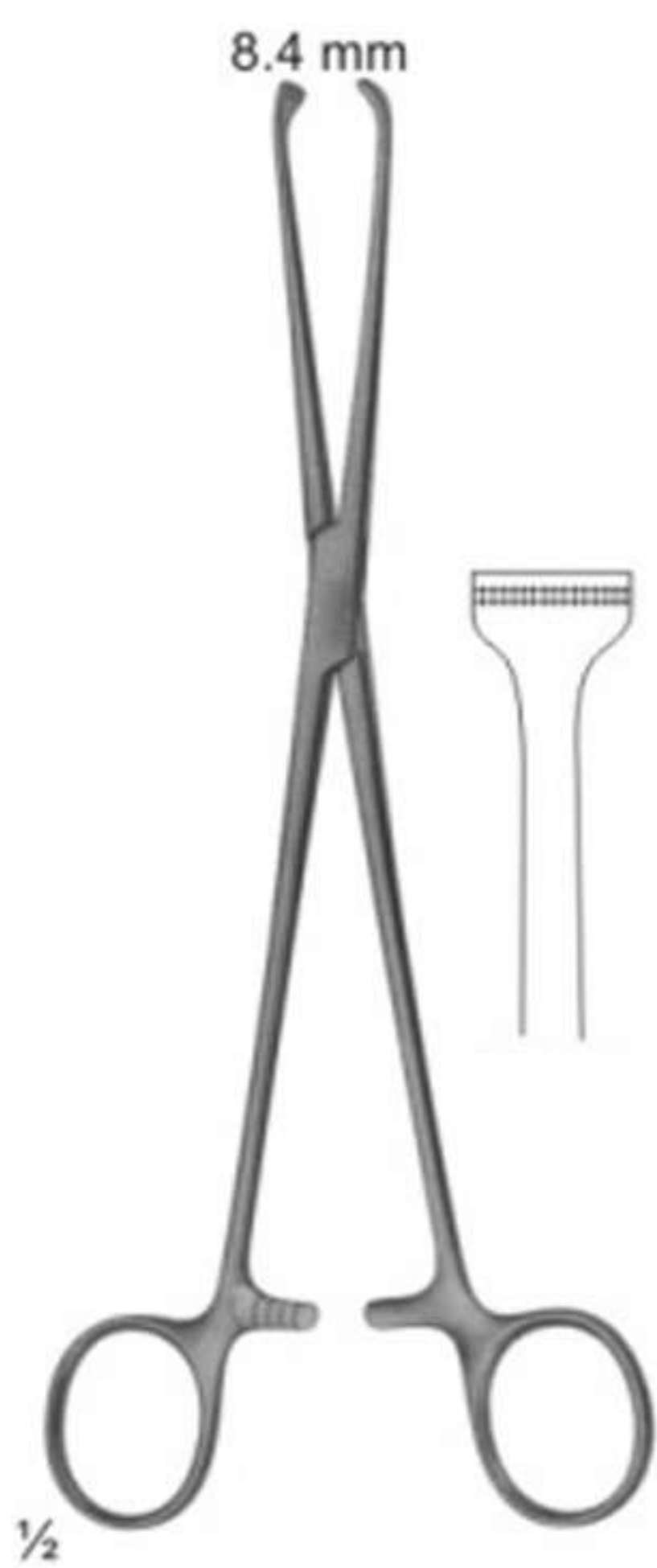
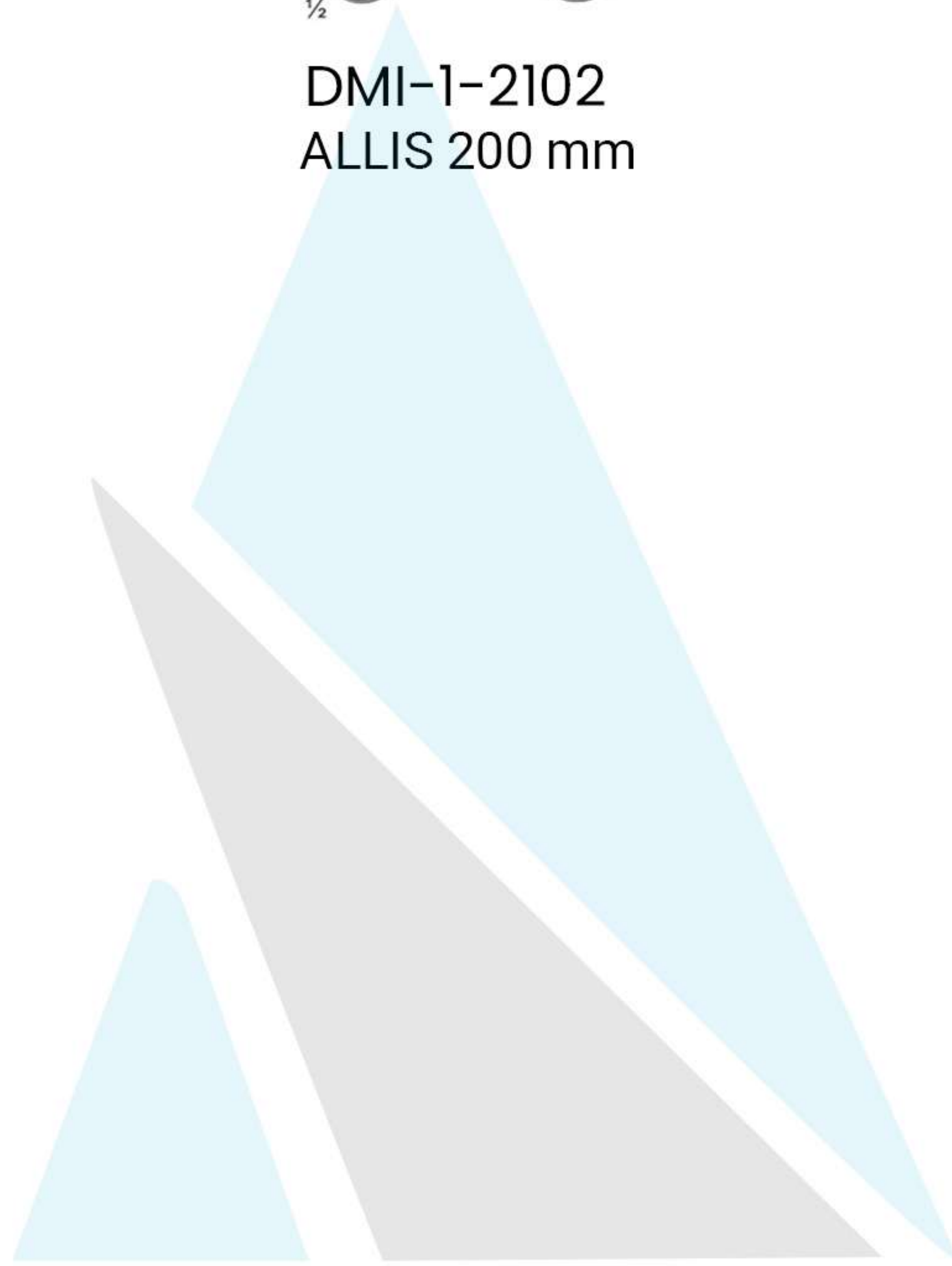

DMI-1-2104
ALLIS 255 mm

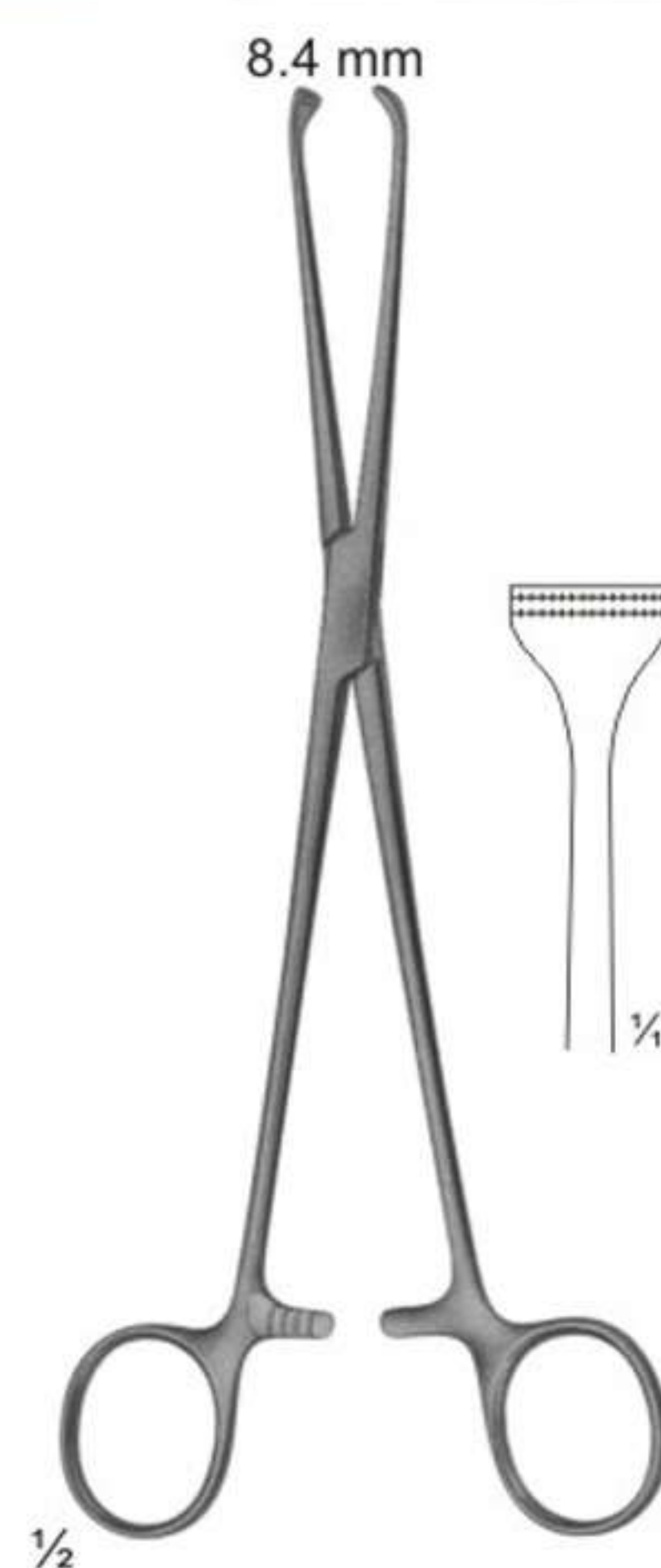

DMI-1-2105
ALLIS 300 mm

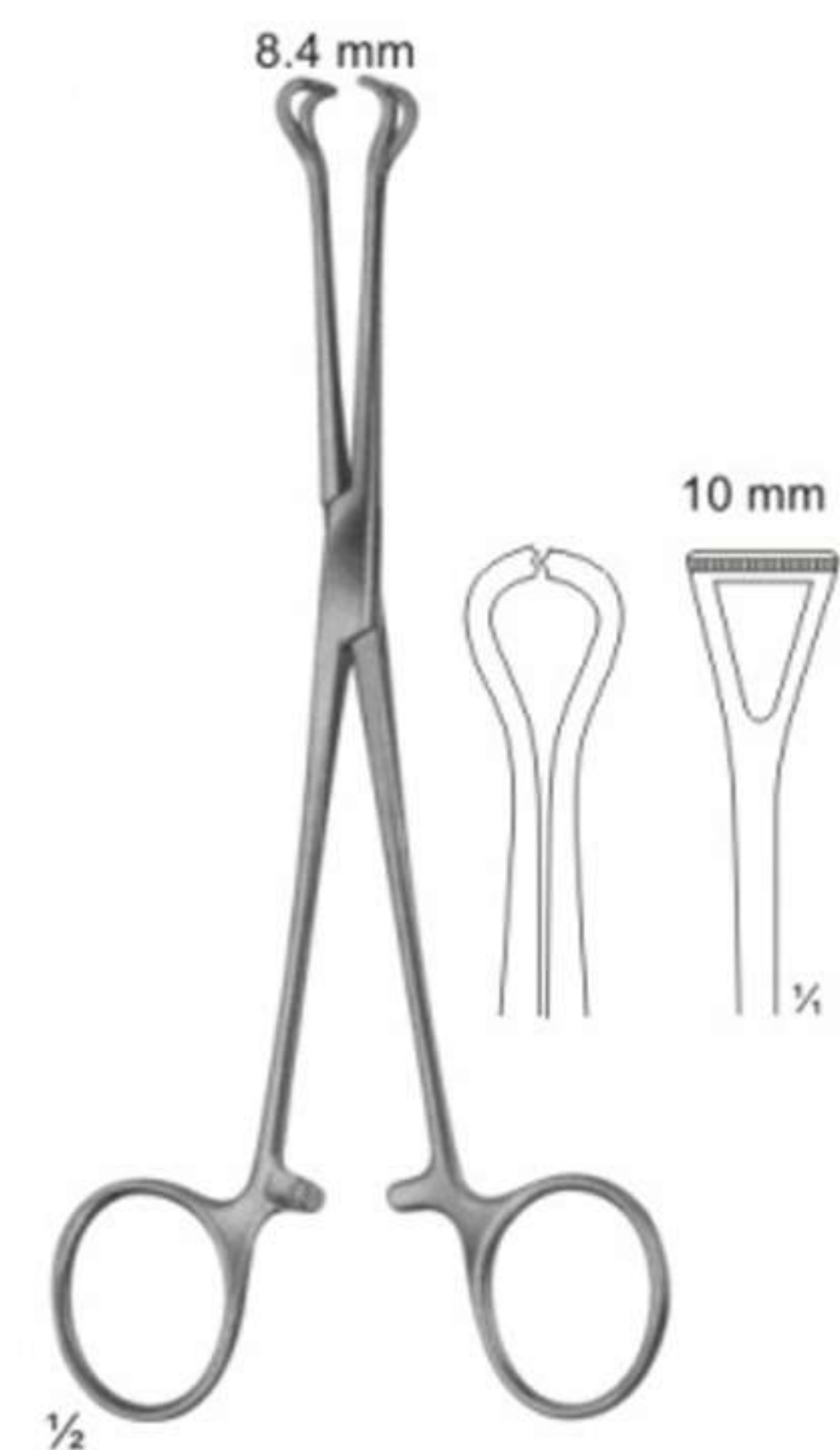

DMI-1-2106
BABCOCK

**Abdominal Surgery Intestinal
and Rectal Instruments**

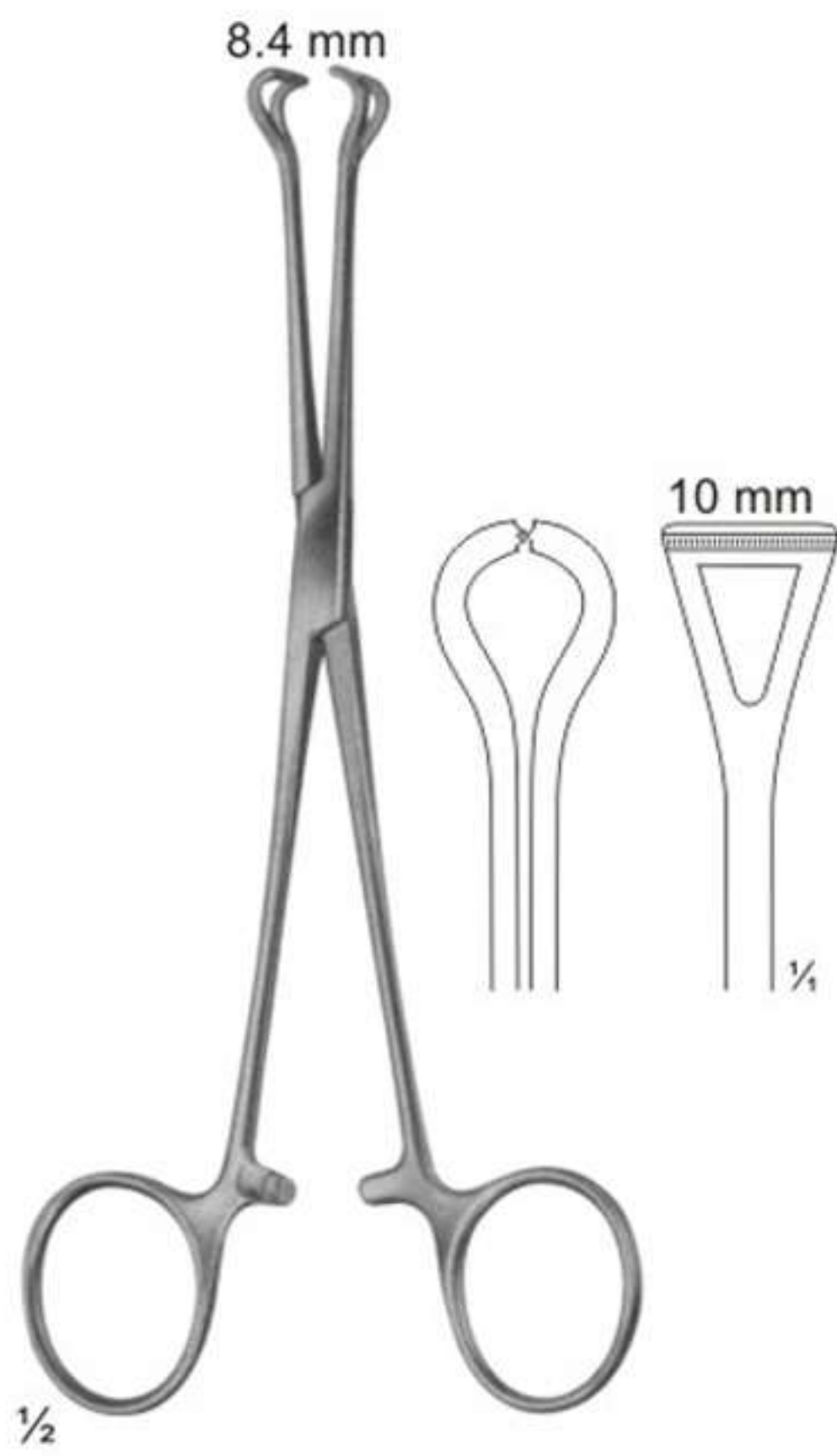

DMI-1-2107
215 mm



DMI-1-2108
COLLIN195 mm



DMI-1-2109
COLLIN230 mm



DMI-1-2110
DOYENelastic165 mm



DMI-1-2111
DOYENelastic165 mm



DMI-1-2112
DOYENwith elastic blades170 mm

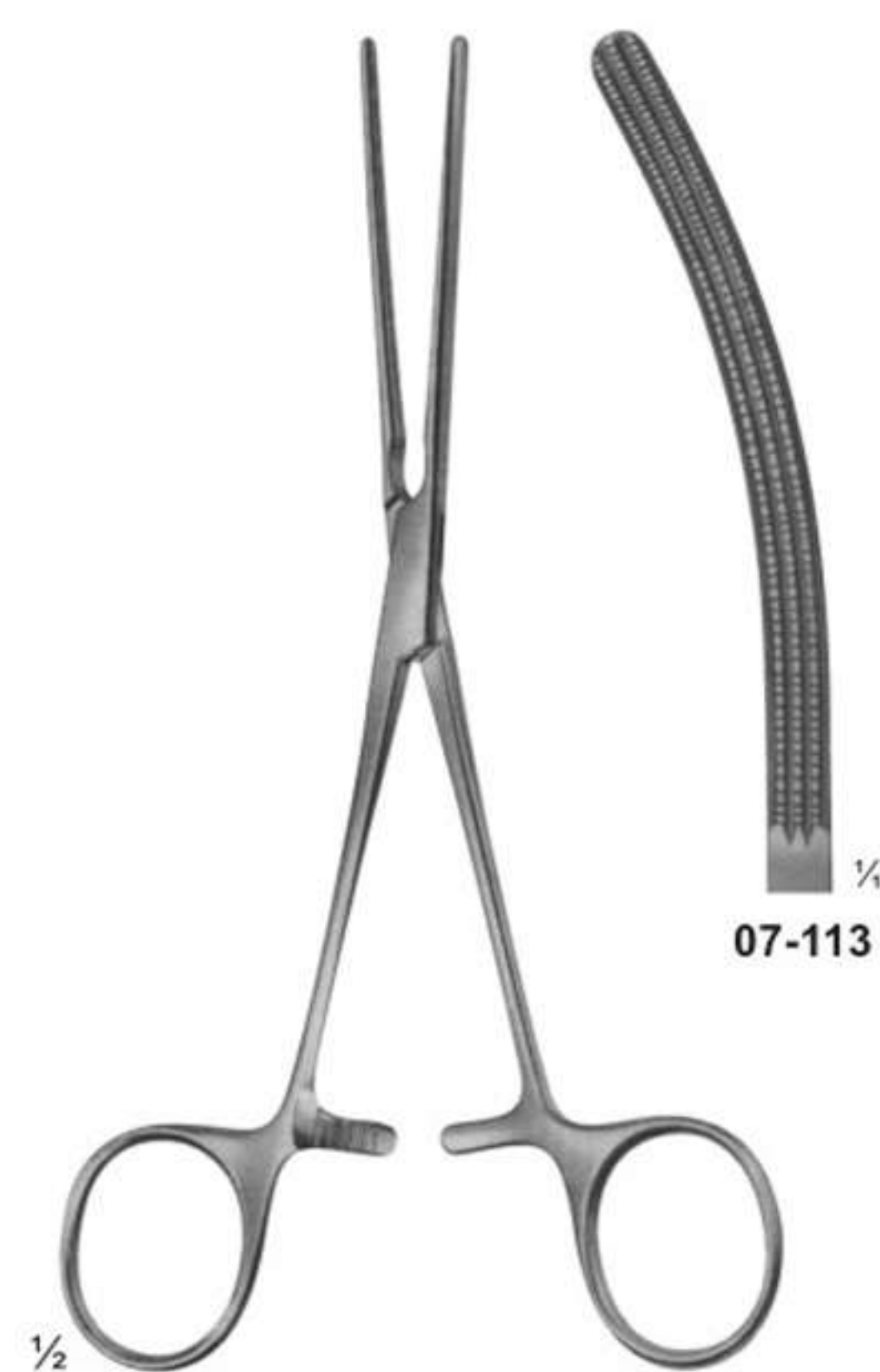

DMI-1-2113
DOYEN with elastic
blades 170 mm



DMI-1-2114
HARTMANN with elastic
blades 200 mm



DMI-1-2115
HARTMANN with elastic
blades 200 mm



DMI-1-2116
JAEGER 135 mm



DMI-1-2117
HARTMANN with elastic
blades 200 mm



DMI-1-2118
PAYR Intestinal clamp light pattern,
for children 180 mm

Abdominal Surgery Intestinal and Rectal Instruments



DMI-1-2119
PAYR 200 mm



DMI-1-2120
PAYR 275 mm



DMI-1-2121
PAYR Pylorus clamp 315 mm



DMI-1-2122
MORRIS 175 mm



DMI-1-2123
DE BAKEY (MORRIS modif.) 240 mm



DMI-1-2124
KERSTING 270 mm

Abdominal Surgery Intestinal and Rectal Instruments



DMI-1-2125
Martin 13 cm / 5 1/8"



DMI-1-2126
SIMS 160 mm

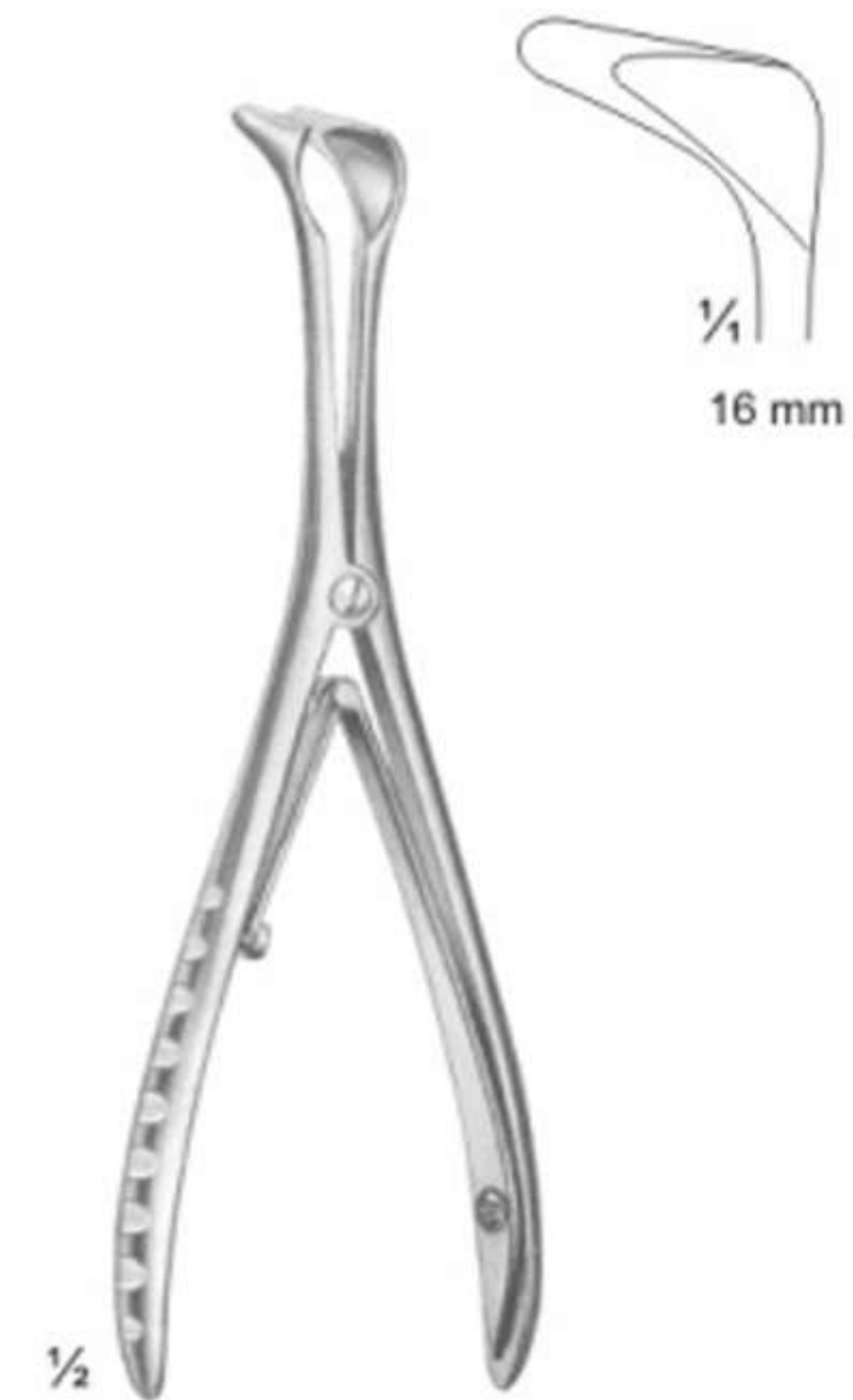

DMI-1-2127
Tieck-Halle 13 cm / 5 1/8"



DMI-1-2128

Fig. 114 cm 5 4/8" 35 mm Fig. 214,5 cm / 5 4/8" 50 mm Fig. 214,5 cm / 5 4/8" 50 mm Fig. 417 cm / 6 6/8" 85 mm



DMI-1-2129

Cottle Fig. 113,5 cm / 5 3/8" 35 mm Fig. 214 cm / 5 4/8" 50 mm Fig. 316 cm / 6 2/8" 75 mm Fig. 416 cm / 6 2/8" 85 mm



DMI-1-2130

Goldsmith Goldsmith (Thudichum) 6,5 cm / 2 4/8" Fig. 121,0 x 9,5 mm Fig. 221,0 x 10,5 mm Fig. 321,0 x 11,5 mm

**Abdominal Surgery Intestinal
and Rectal Instruments**

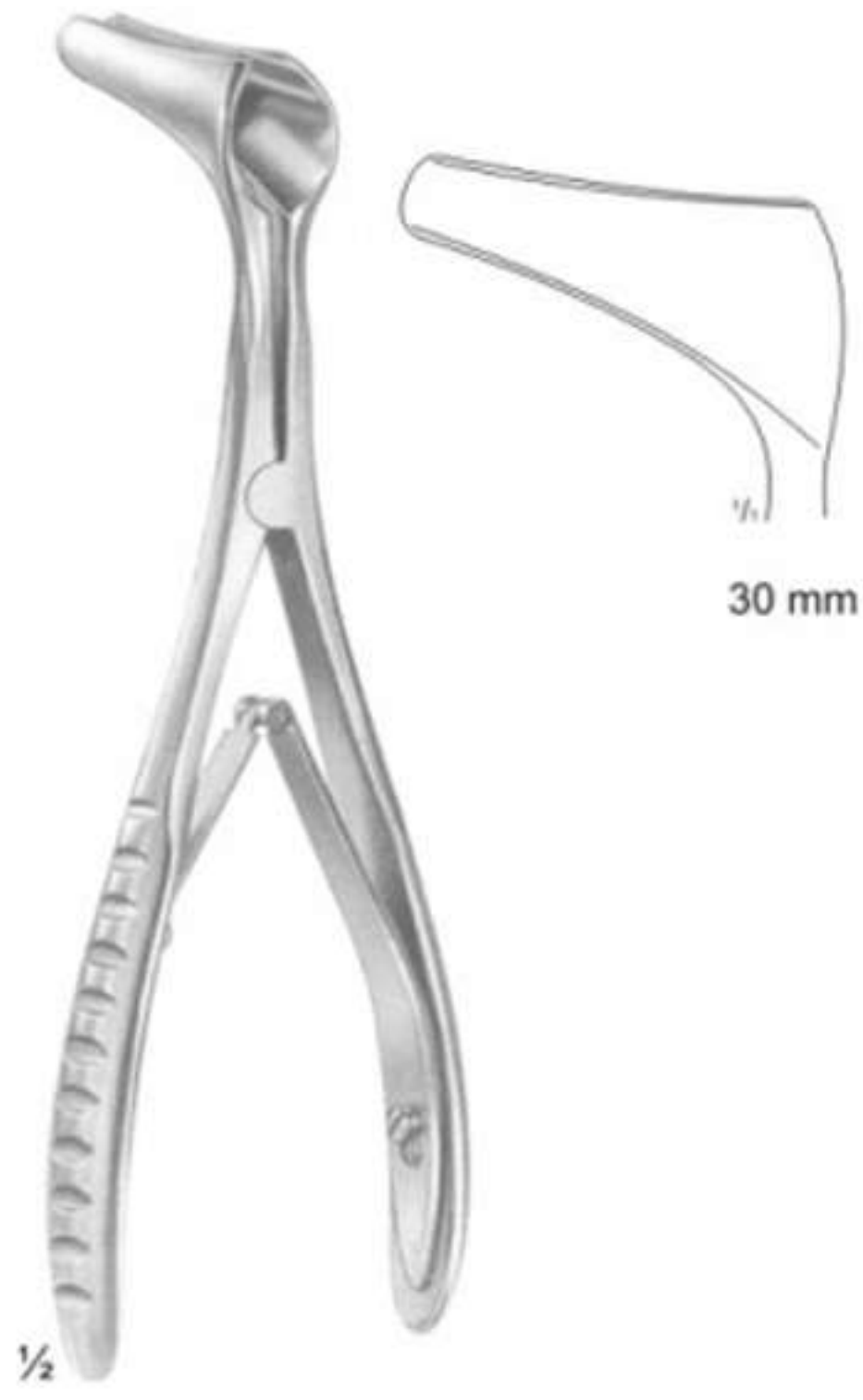

DMI-1-2131
Mod. Wien 13,5 cm / 5 2/8"



DMI-1-2132
Hartmann-Halle 16 cm / 6 2/8" Fig. 127 mm Fig. 231 mm Fig. 335 mm



DMI-1-2133
IVES-FANSLER Anuscops 145 mm



DMI-1-2134
KELLY Sphincteroscope 160 mm

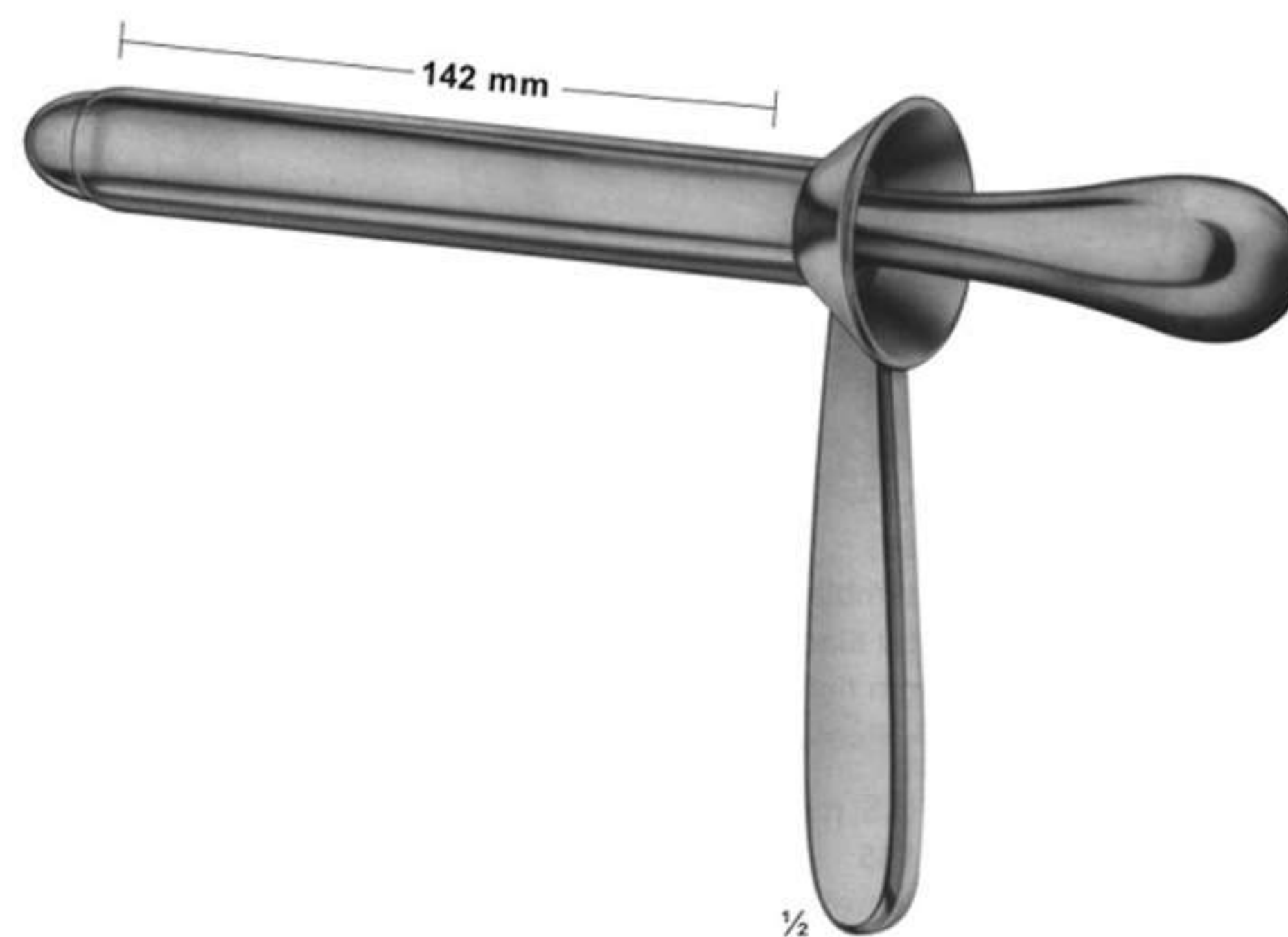

DMI-1-2135
KELLY Proctoscope 140 mm



DMI-1-2136
250 mm



DMI-1-2137
270 mm



DMI-1-2138
FERGUSSON200 mmmm

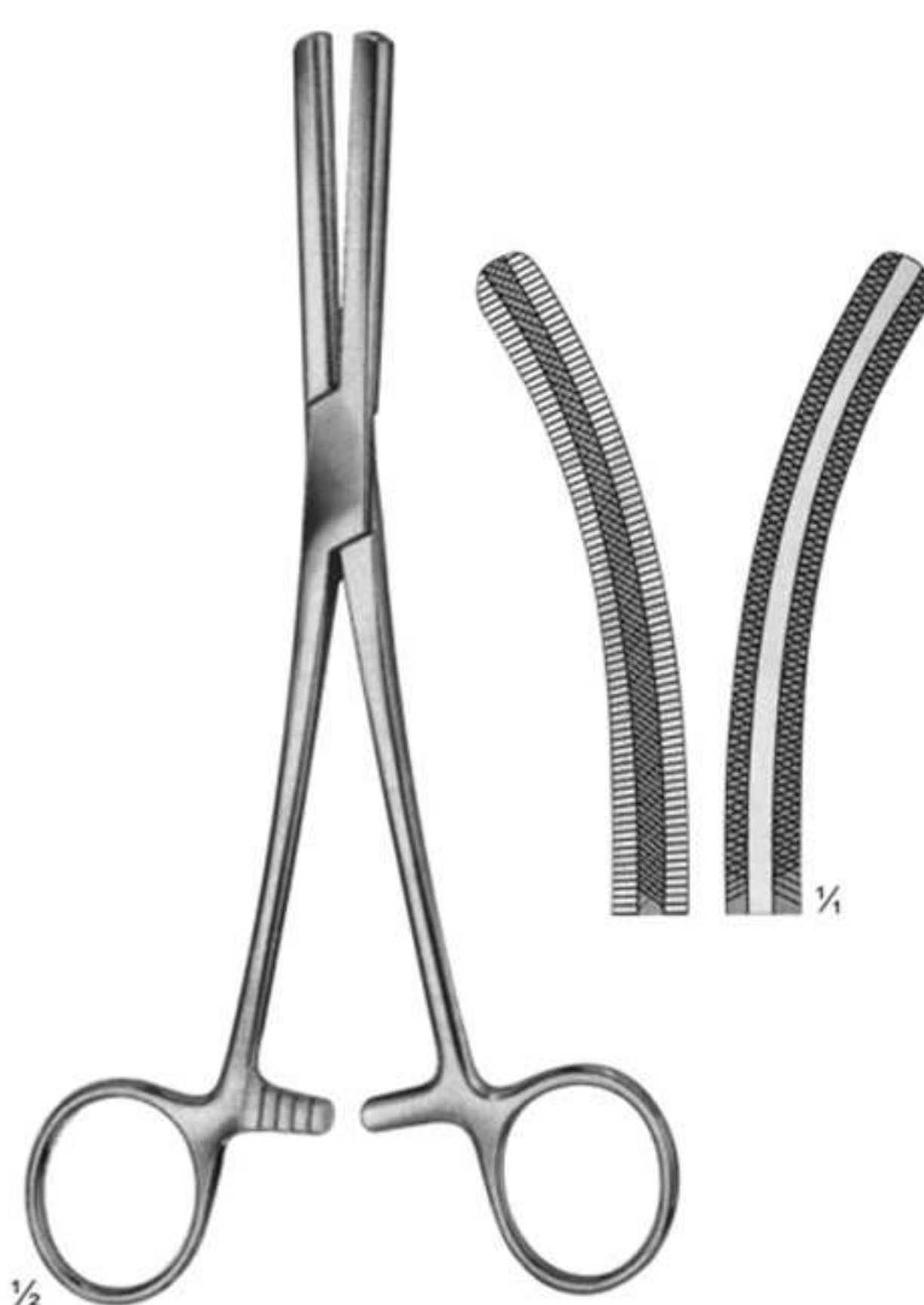

DMI-1-2139
FERGUSSON200 mm



DMI-1-2140
RUDDHaemorrhoidal ligator with loading
attachment and 100 ligature rubber rings 315 mm

Gall Bladder liver and Spleen Instruments



DMI-1-2201
LOWER 180 mm



DMI-1-2202
LAHEY (SWEET) 190 mm



DMI-1-2203
LAHEY 220 mm



DMI-1-2204
DESJARDIN Gall duct-and cystic
forceps 210 mm



DMI-1-2205
NISSEN Gall duct-and cystic forceps 215 mm



DMI-1-2206
DITTEL Metall bougies and dilating
sounds, stiff 345 mm

**Gall Bladder liver and
Spleen Instruments**

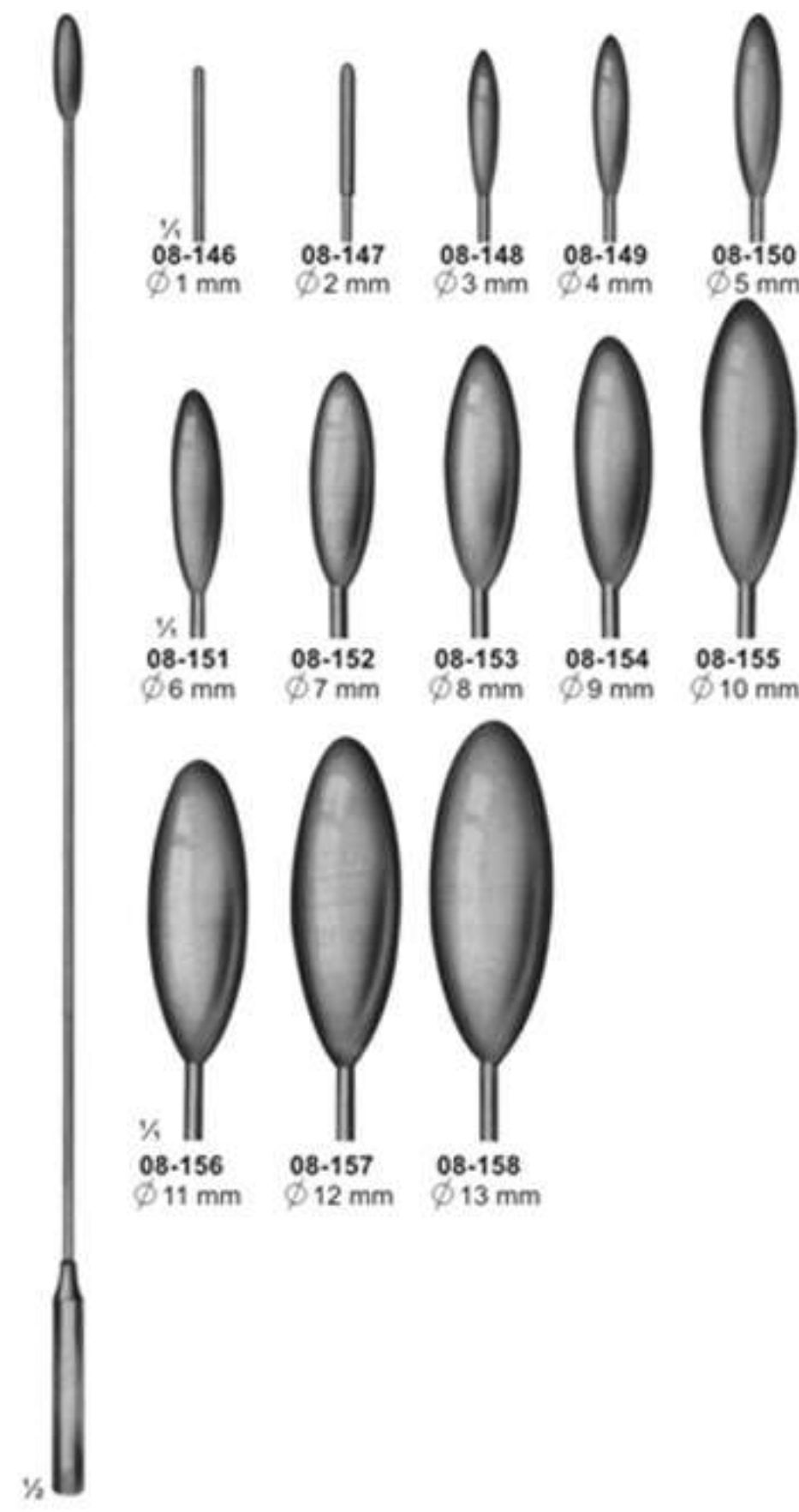

DMI-1-2207
BAKES Common bile duct dilators,
malleable 08-146 - 08-150 315 mm
08-151- 08-158 320 mm

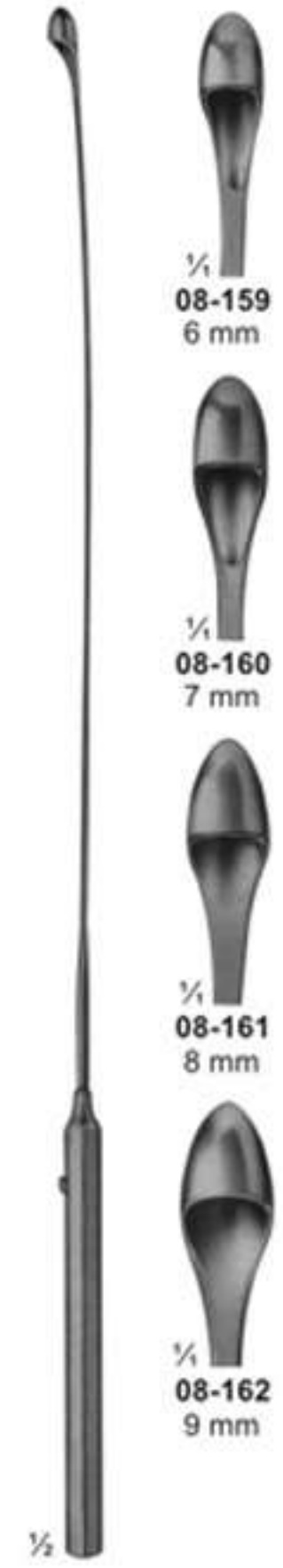

DMI-1-2208
DESJARDIN Probe and catch with
flexible schaft 300 mm

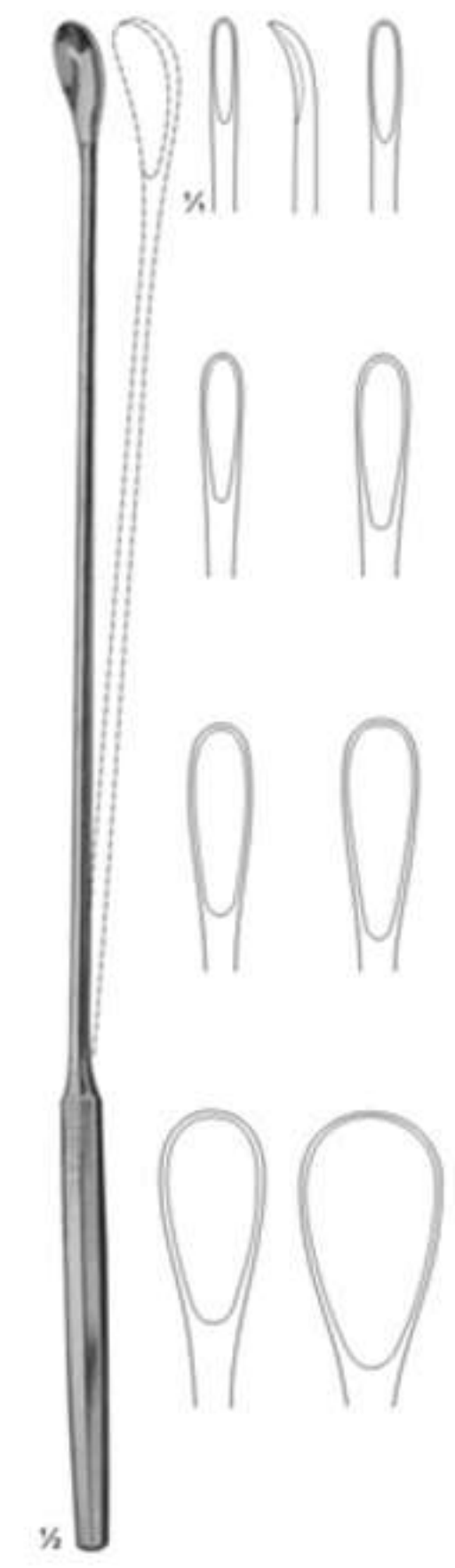

DMI-1-2209
LUER-KOERTE modif with
malleable shaft 310 mm

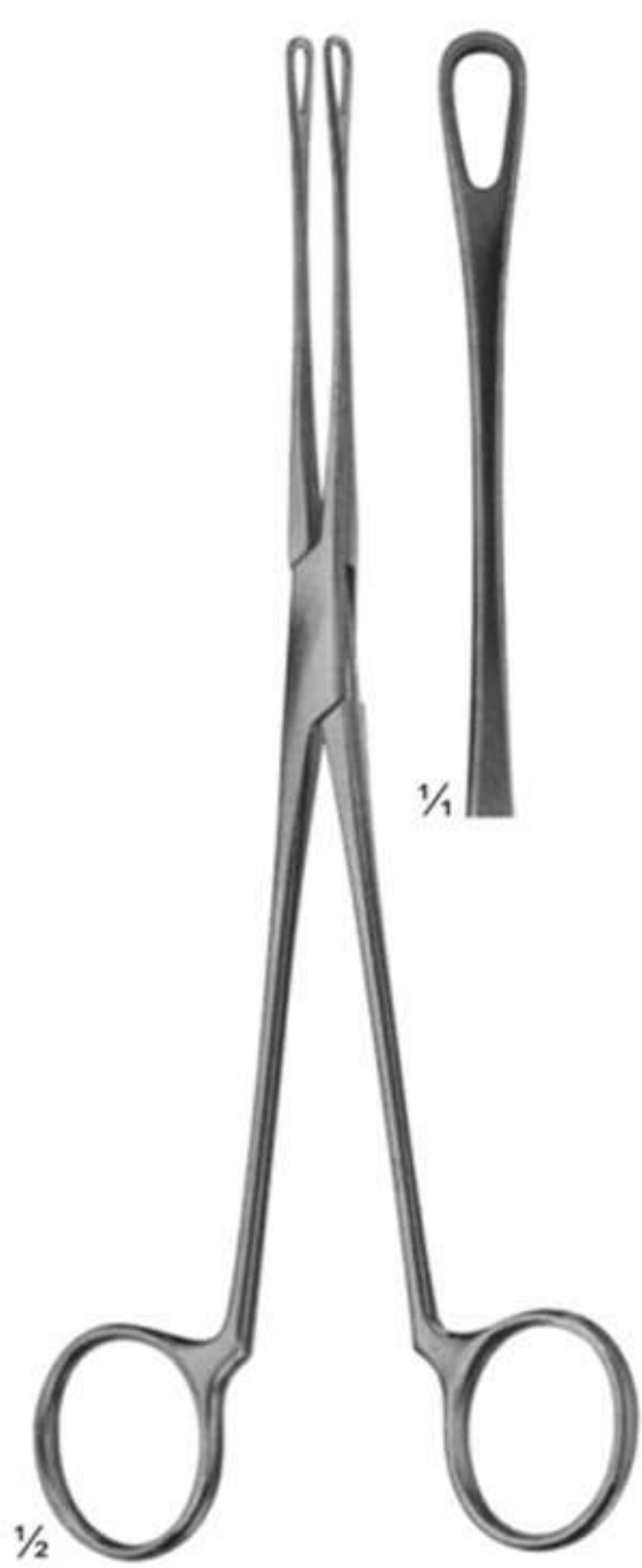

DMI-1-2210
BLAKE 205 mm

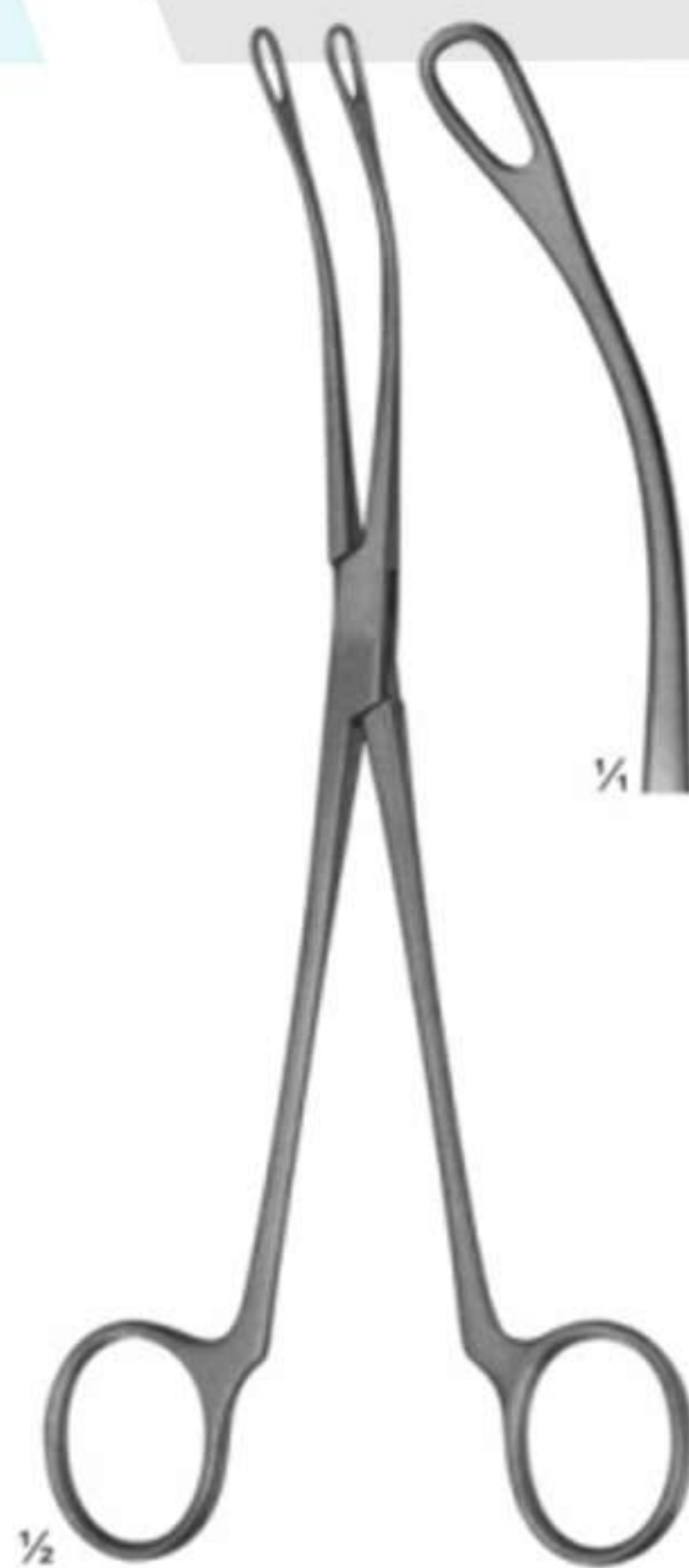

DMI-1-2211
BLAKE 205 mm

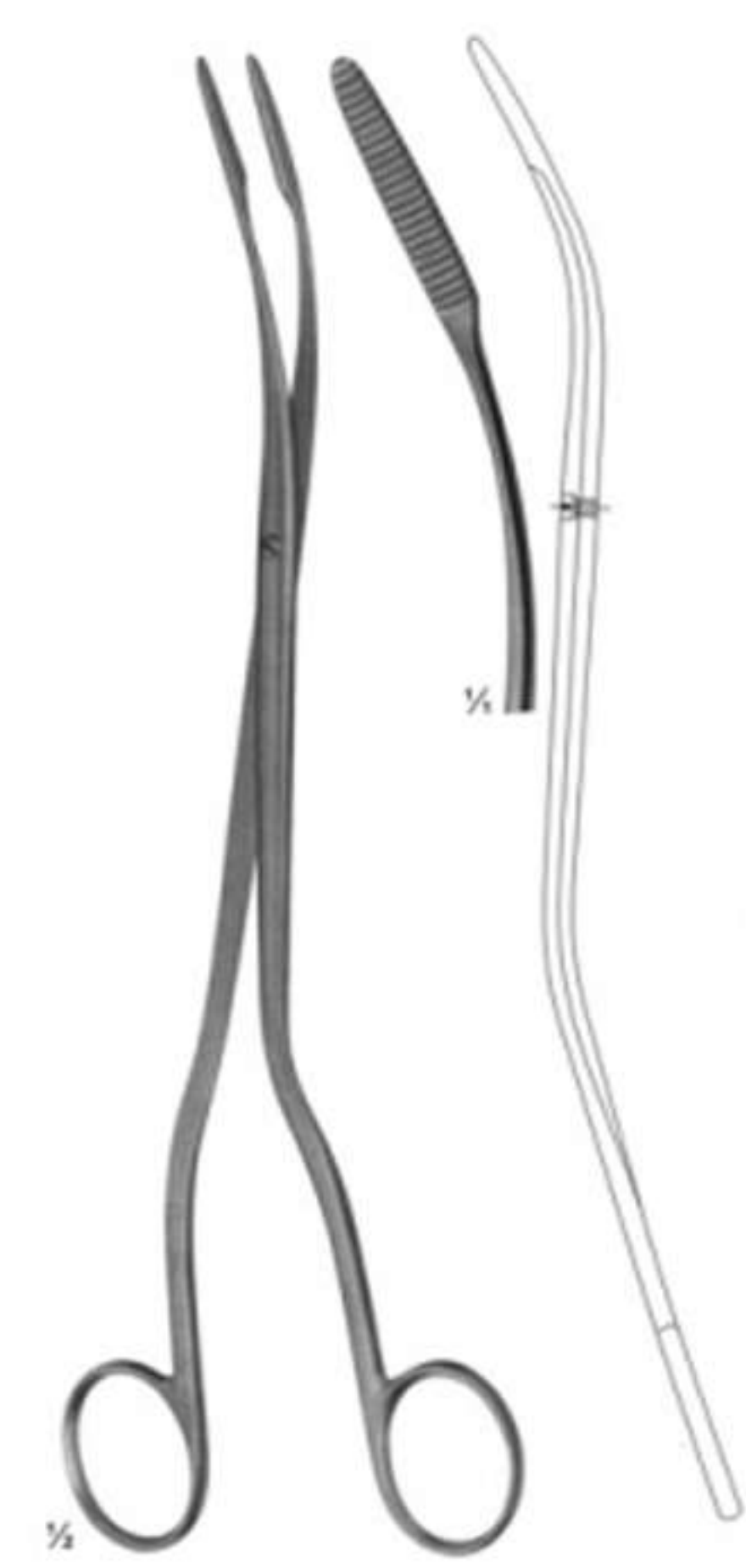

DMI-1-2212
CZERNY 245 mm

**Gall Bladder liver and
Spleen Instruments**

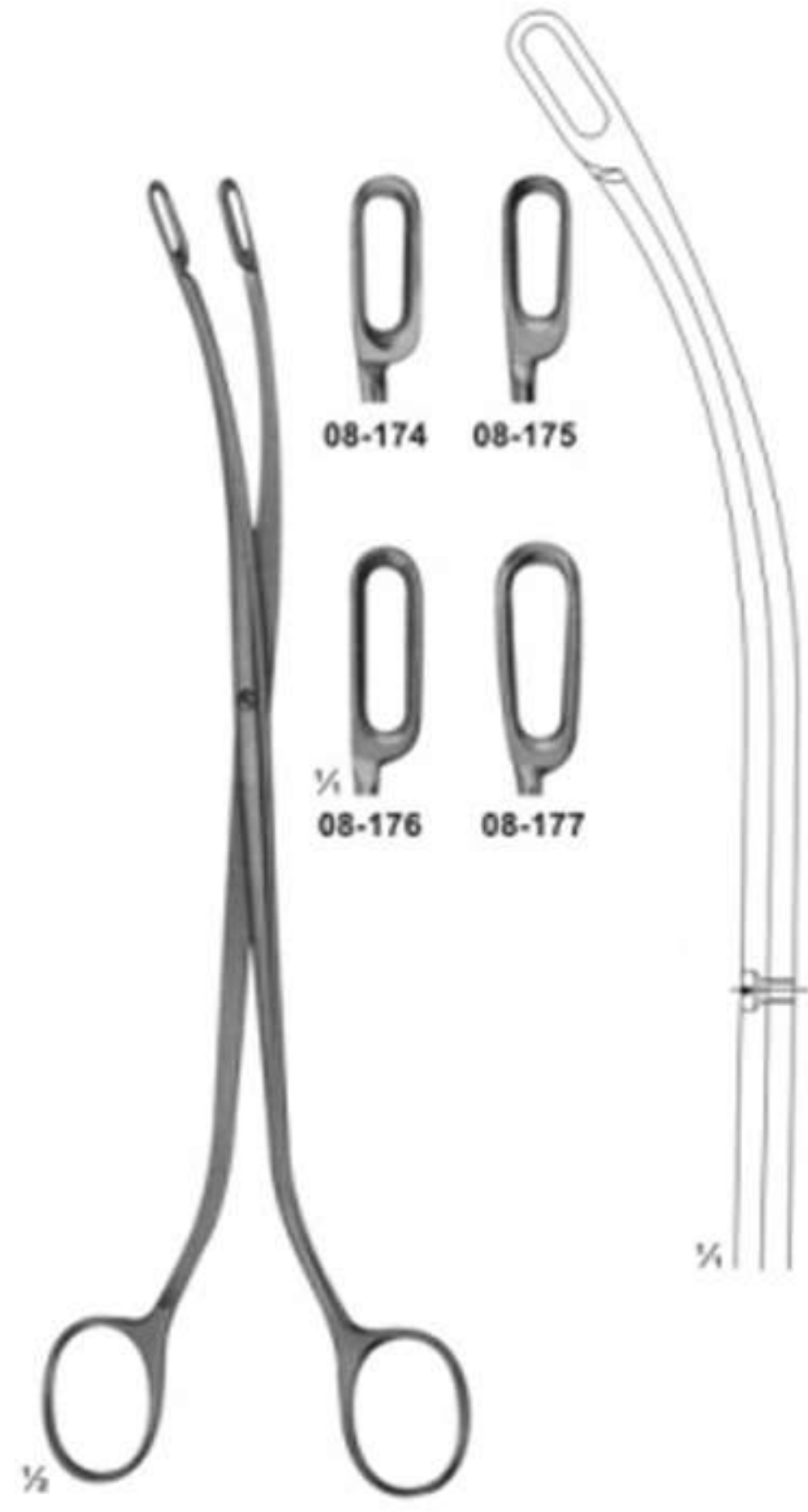

DMI-1-2213
DESJARDINS225 mm

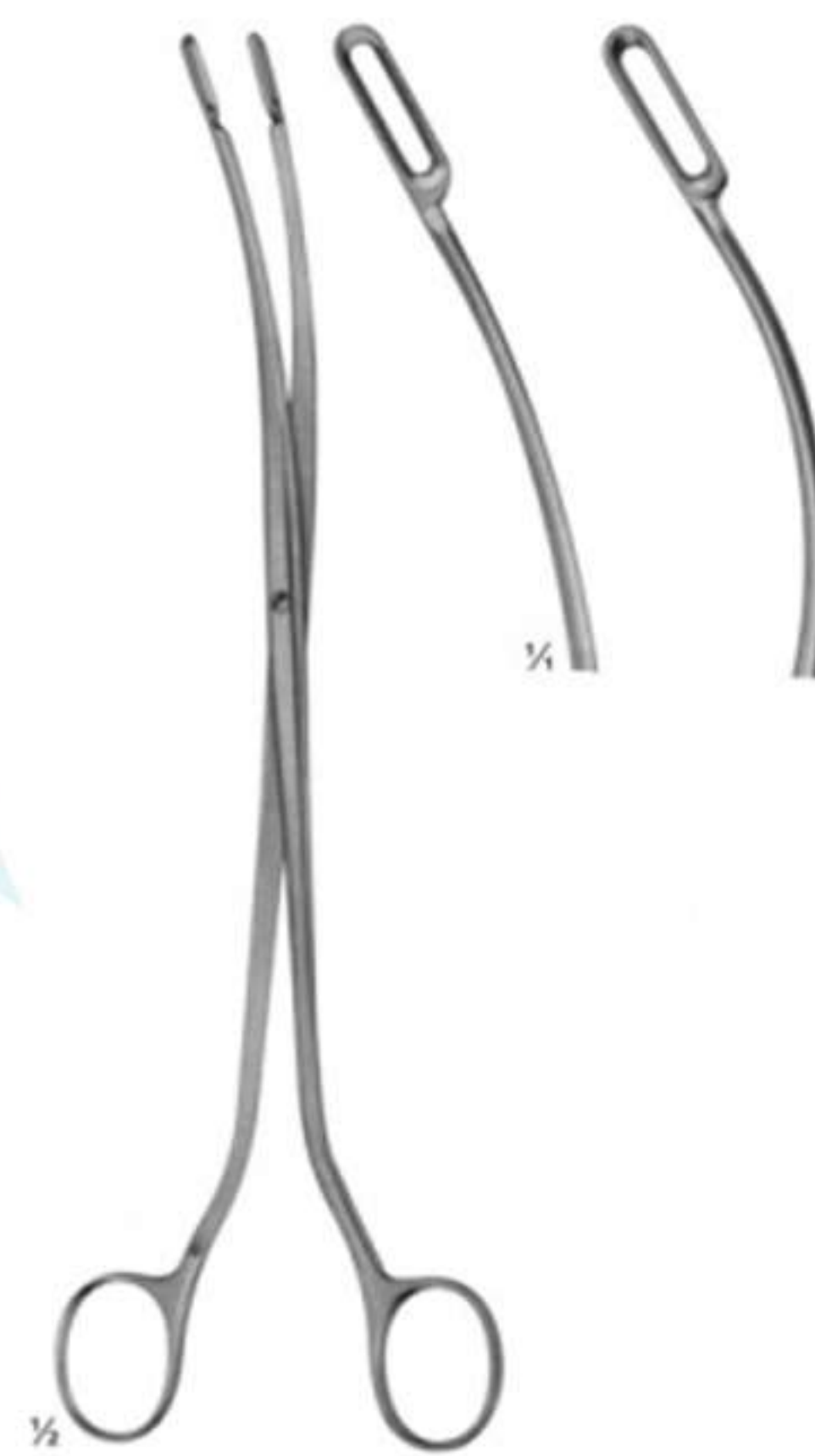

DMI-1-2214
DESJARDINSExtremely delicatepatterns

**Genito Urinary Instruments
and Trocars**



DMI-1-2301
GUYON 240 mm 230 mm



DMI-1-2302
GUYON GUYON 230 mm



DMI-1-2303
PEAN 195 mm

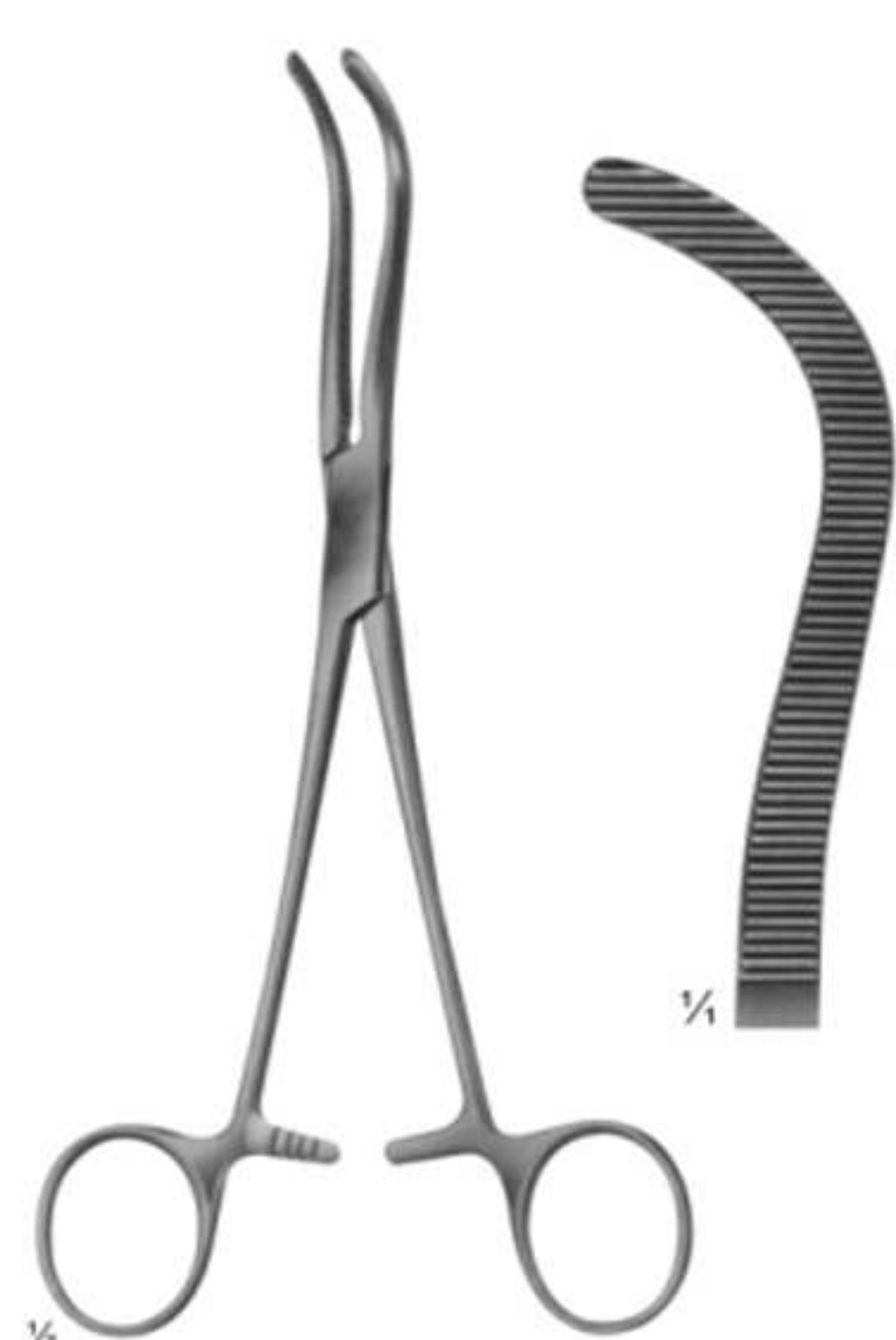

DMI-1-2304
PEAN 220 mm

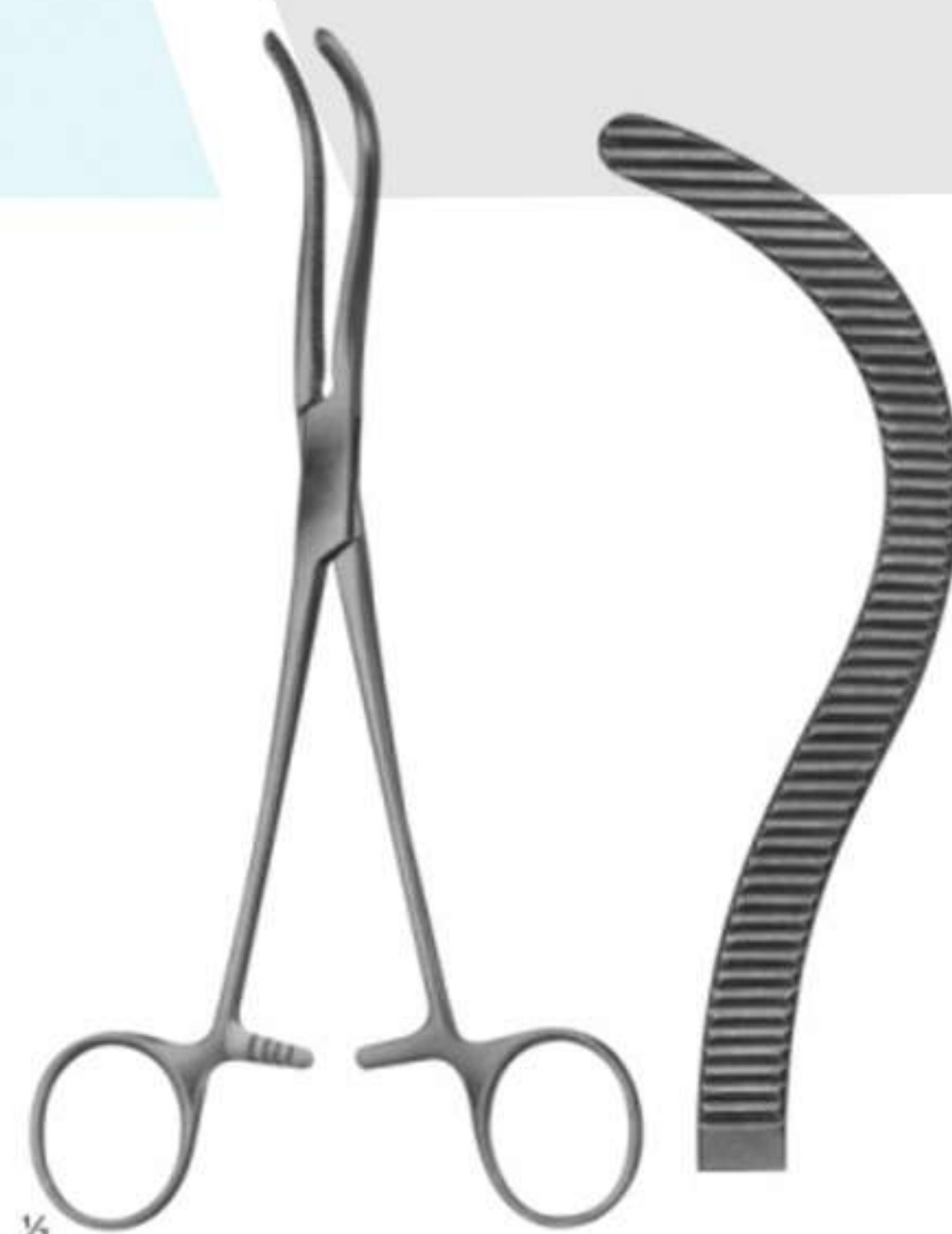

DMI-1-2305
PEAN 230 mm



DMI-1-2306
RANDALL 225 mm



DMI-1-2307
RANDALL225 mm



DMI-1-2308
RANDALL225 mm



DMI-1-2309
RANDALL225 mm



DMI-1-2310
RANDALL190 mm



DMI-1-2311
RANDALL190 mm



DMI-1-2312
RANDALL190 mm



DMI-1-2313
JUDD-MASSON Bladder and
suprapubic retractor

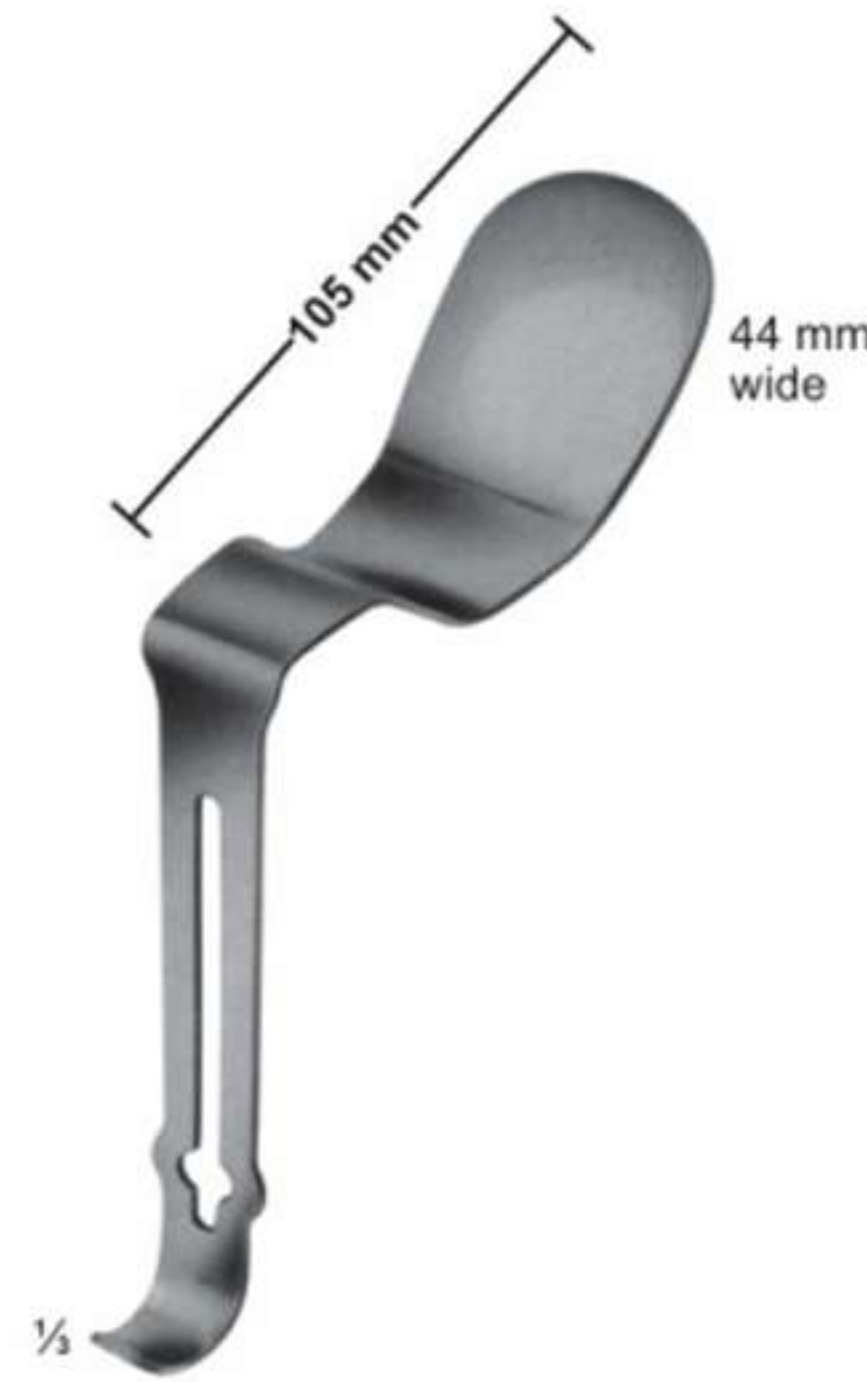

DMI-1-2314
MILLIN Center bladder for retro
pubic prostatectomy



DMI-1-2315
MILLIN Bladder retractor,
complete 105 X 45 mm



DMI-1-2316
LEGUEU Bladder retractor
Center blade 80 x 31 mm



DMI-1-2317
KOCHER Bladder spatula 235 mm



DMI-1-2318
KLIMA ROSEGGER 35 X 1,8 mm Sternal
puncture needle

Vaginal Specula and Uterine Dilators

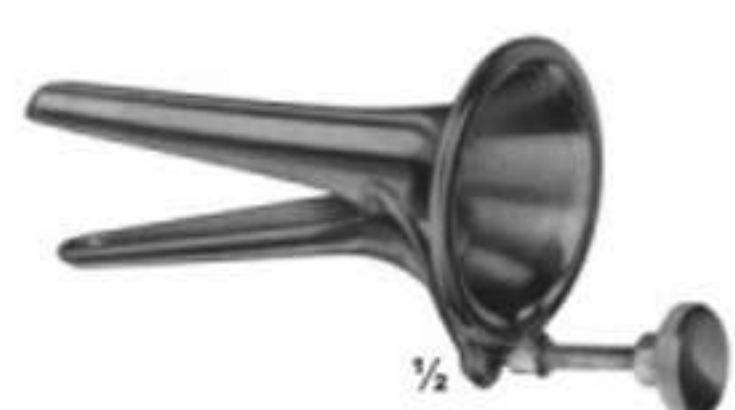

DMI-1-2401
COLLINfor children53 x 10 mm

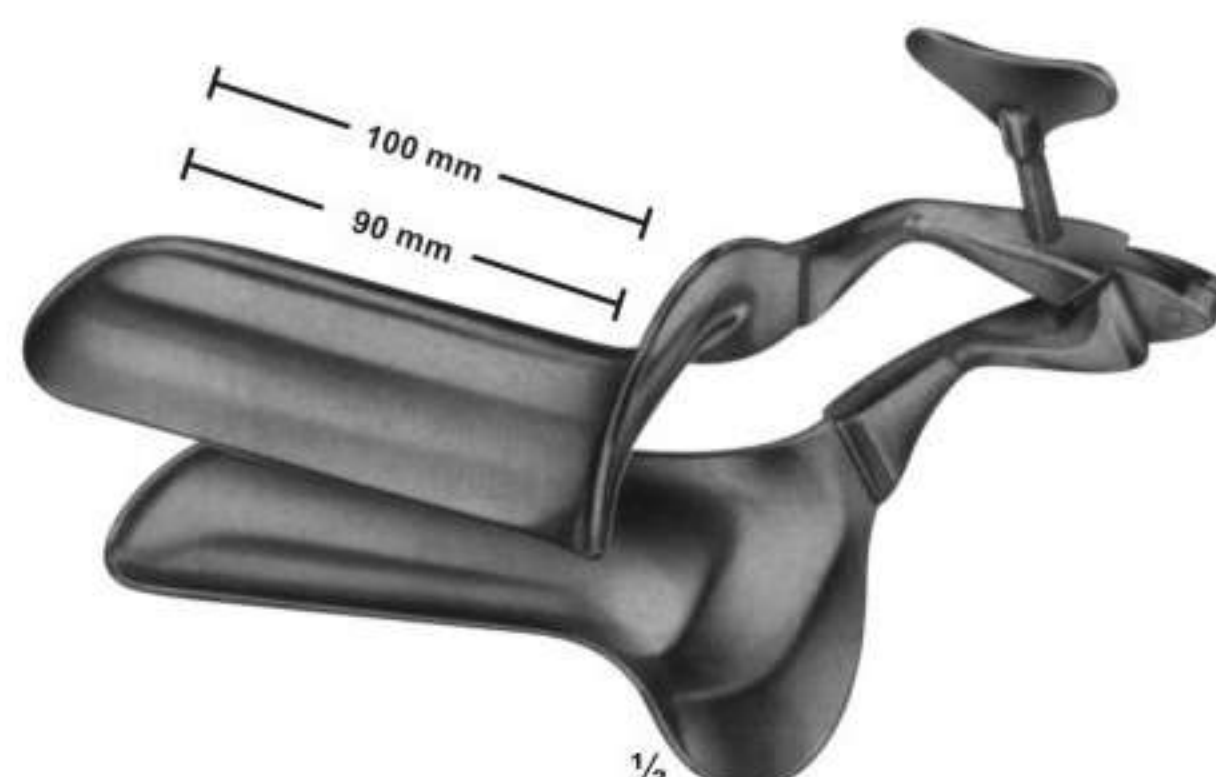

DMI-1-2402
COLLIN10-102 100/90mm 28 mm10-103 100/90mm
32 mm10-104 105/95mm 35 mm10-105 115/105mm
40 mmTotal length/working widthlength



DMI-1-2403
COLLINfor virgins95/85 x 18 mm



DMI-1-2404
CUSCOfor virgins75 x17 mm



DMI-1-2405
CUSCOfor virgins75 x17 mm

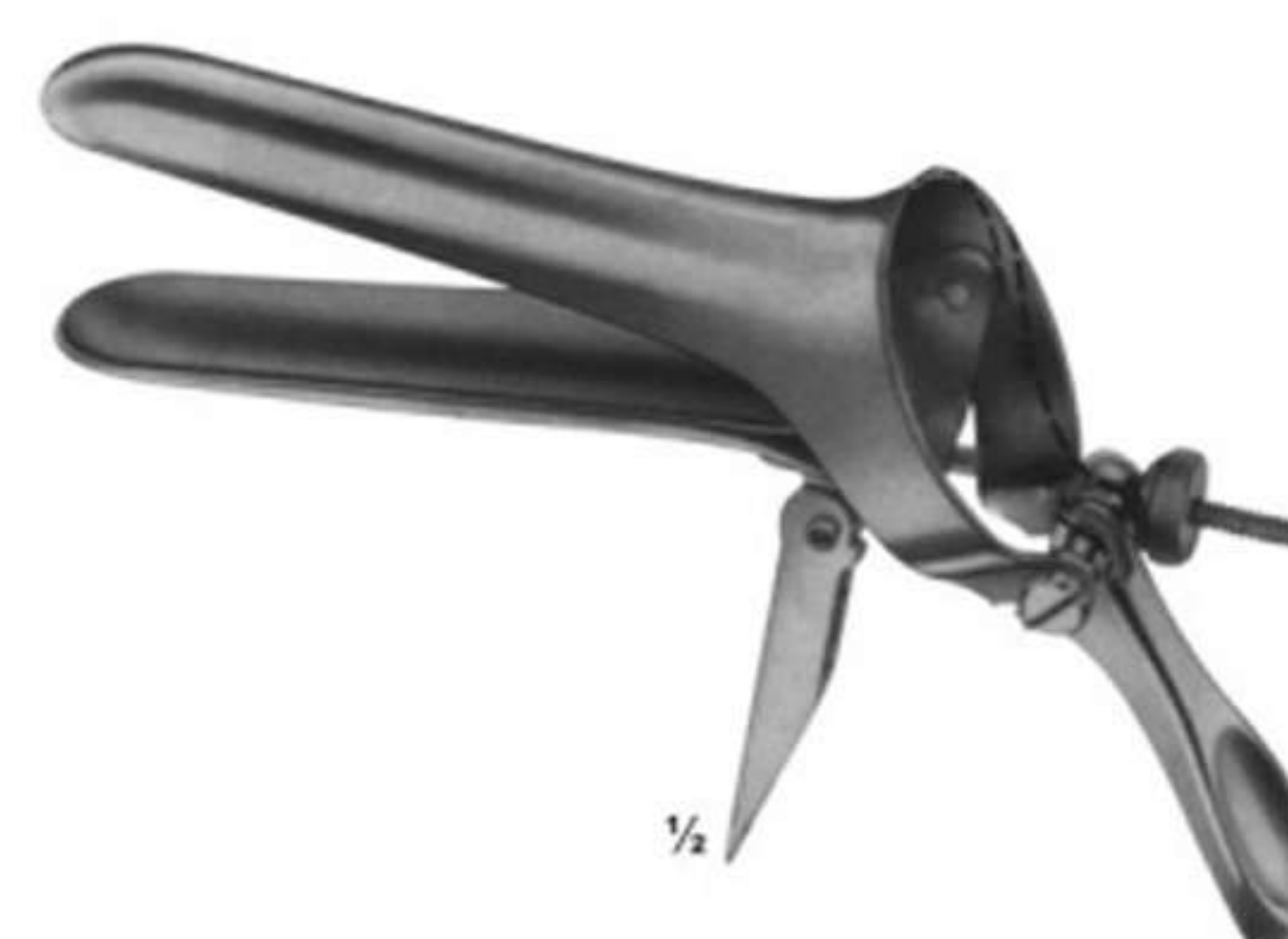

DMI-1-2406
CUSCO10-109 92X23-25 mm10-110
100x25-27 mm10-111 110x27-30 mm

Vaginal Specula and Uterine Dilators



DMI-1-2407
 GRAVE 10-112 75X20 mm 10-113
 95X30 mm 10-114 105X33 mm



DMI-1-2408
 PEDERSON 10-115 100X22 mm 10-116 120X25 mm



DMI-1-2409
 BRIESKY 10-117 72X25 mm / 77X30 mm
 140 mm 10-118 75X30 mm / 92X38 mm 170 mm



DMI-1-2410
 SIMS 70 X 26 mm / 75 X 30 mm 75 X 30 mm /
 80 X 35 mm 80 X 36 mm /
 90 X 40 mm 175 mm



DMI-1-2411
 SEIDL 10-120 80X8 mm 10-121 80X10 mm
 10-122 90X14 mm For children and
 infants 170 mm



DMI-1-2412
 KRISTELLER 70X15 mm,
 (170 mm) For children

Vaginal Specula and Uterine Dilators



DMI-1-2413
KRISTELLER10-124 70X27 mm
10-125 75X30 mm 10-126 90X36 mm 175 mm



DMI-1-2414
KRISTELLER10-127 110X18 mm10-128 110X20 mm10-129 110X27 mm10-130 110X30 mm10-131 110X36 mm220 mm



DMI-1-2415
KRISTELLERUpper blades

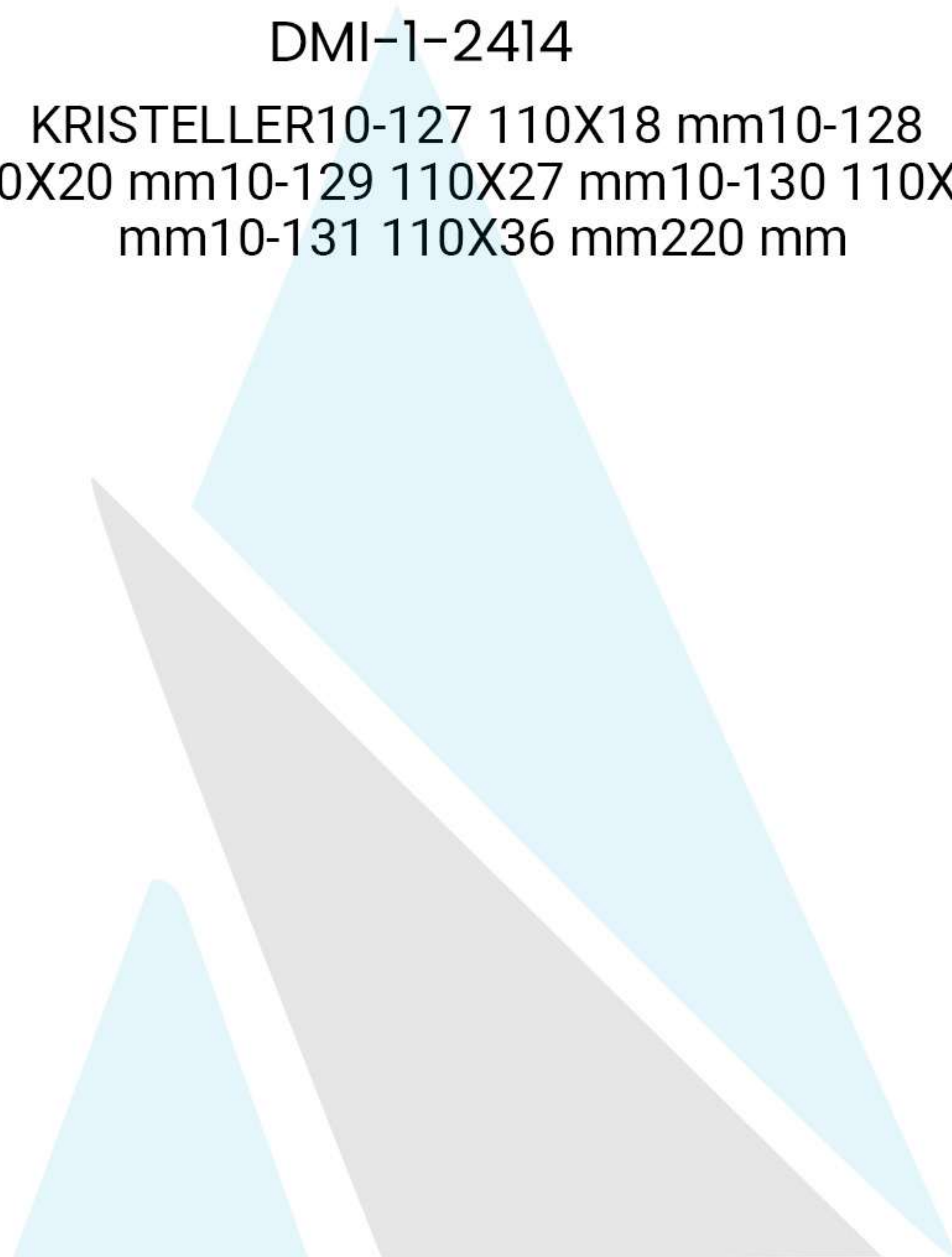

DMI-1-2416
KRISTELLERLower blades



DMI-1-2417
DOYEN235 mm



DMI-1-2418
DOYEN



DMI-1-2419
JOLL (FRIEDMAN) 155 mm



DMI-1-2420
RICHTER 170 mm



DMI-1-2421
GELPI 135 mm



DMI-1-2422
GELPI 175 mm



DMI-1-2423

HEGAR with very conical point 185 mm 11-101 1 mm 11-102 2 mm 11-103 3 mm 11-104 4 mm 11-105 5 mm 11-106 6 mm 11-107 7 mm 11-108 8 mm 11-109 9 mm 11-110 10 mm 11-111 11 mm 11-112 12 mm 11-113 13 mm 11-114 14 mm 11-115 15 mm 11-116 16 mm 11-117 17 mm 11-118 18 mm 11-119 19 mm 11-120 20 mm 11-121 21 mm 11-122 22 mm 11-123 23 mm 11-124 24 mm 11-125 25 mm 11-126 26 mm 11-127 1 ½ mm 11-128 2 ½ mm 11-129 3 ½ mm 11-130 4 ½ mm 11-131 5 ½ mm 11-132 6 ½ mm 11-133 7 ½ mm 11-134 8 ½ mm 11-135 9 ½ mm 11-136 10 ½ mm 11-137 11 ½ mm 11-138 12 ½ mm 11-139 13 ½ mm 11-140 14 ½ mm 11-141 15 ½ mm 11-142 16 ½ mm 11-143 17 ½ mm



1/2

DMI-1-2424

HEGAR 205 mm 11-144 1+2 mm 11-145 3+4 mm 11-146 5+6 mm 11-147 7+8 mm 11-148 9+10 mm 11-149 11+12 mm 11-150 13+14 mm 11-151 15+16 mm 11-152 17+18 mm

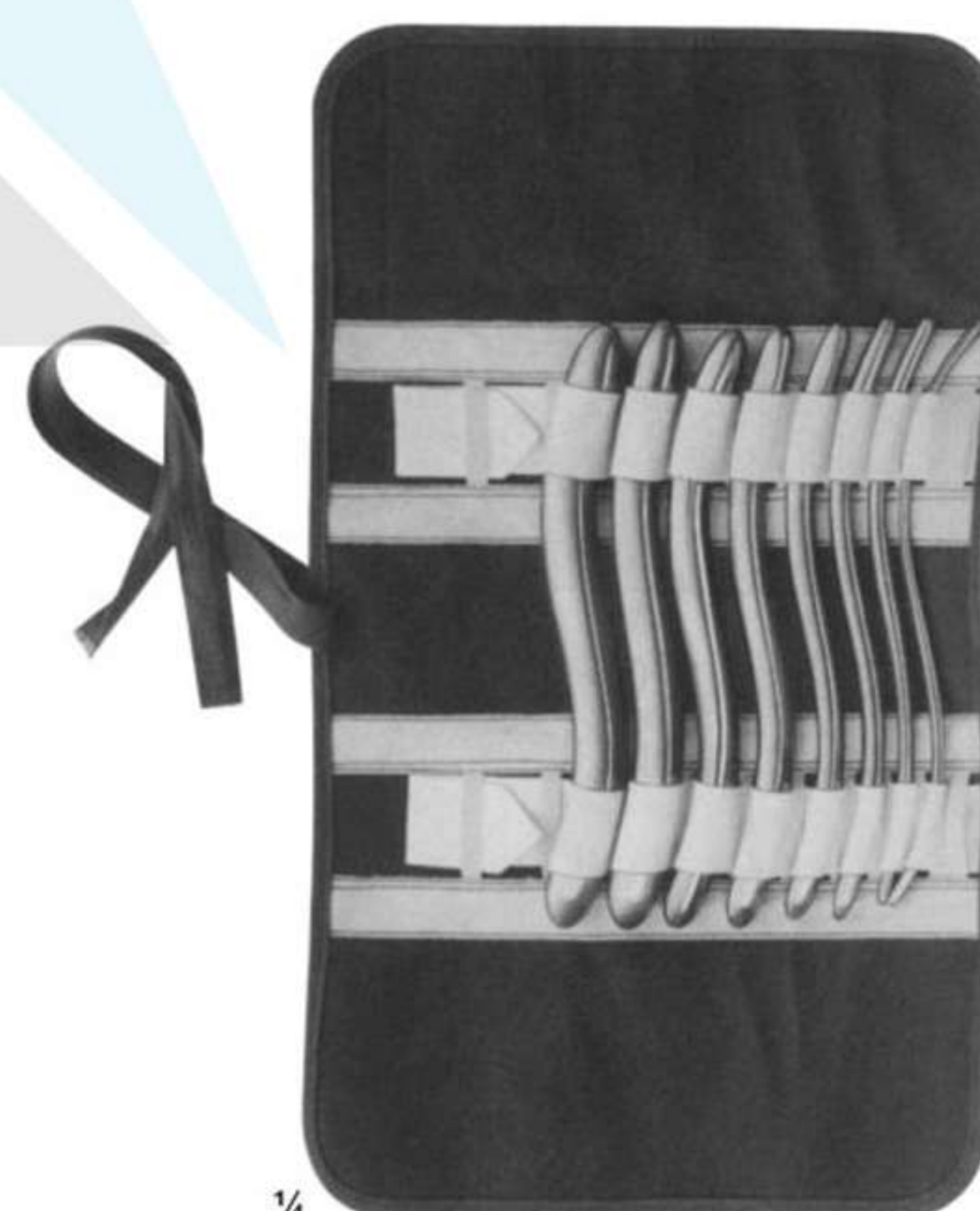
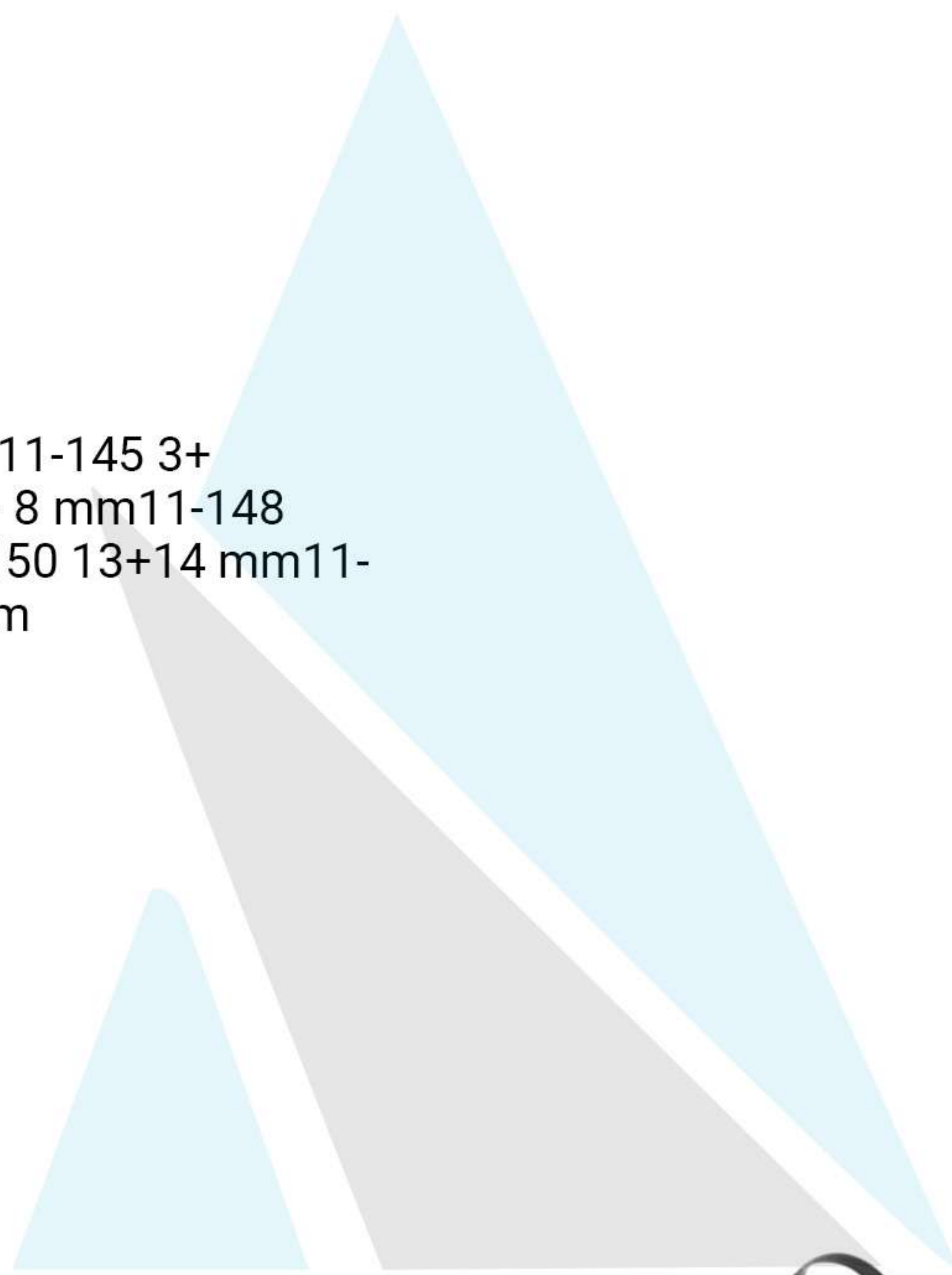

1/4

DMI-1-2425

HEGAR Uterine dilator set, in canvas roll with 8 dilators.

**Uterine Probes, Uterine Dressing,
Polypus and Ovum Forceps**



DMI-1-2501
MAYO malleable 330 mm



DMI-1-2502
SIMS malleable 330 mm



DMI-1-2503
MARTIN 330 mm

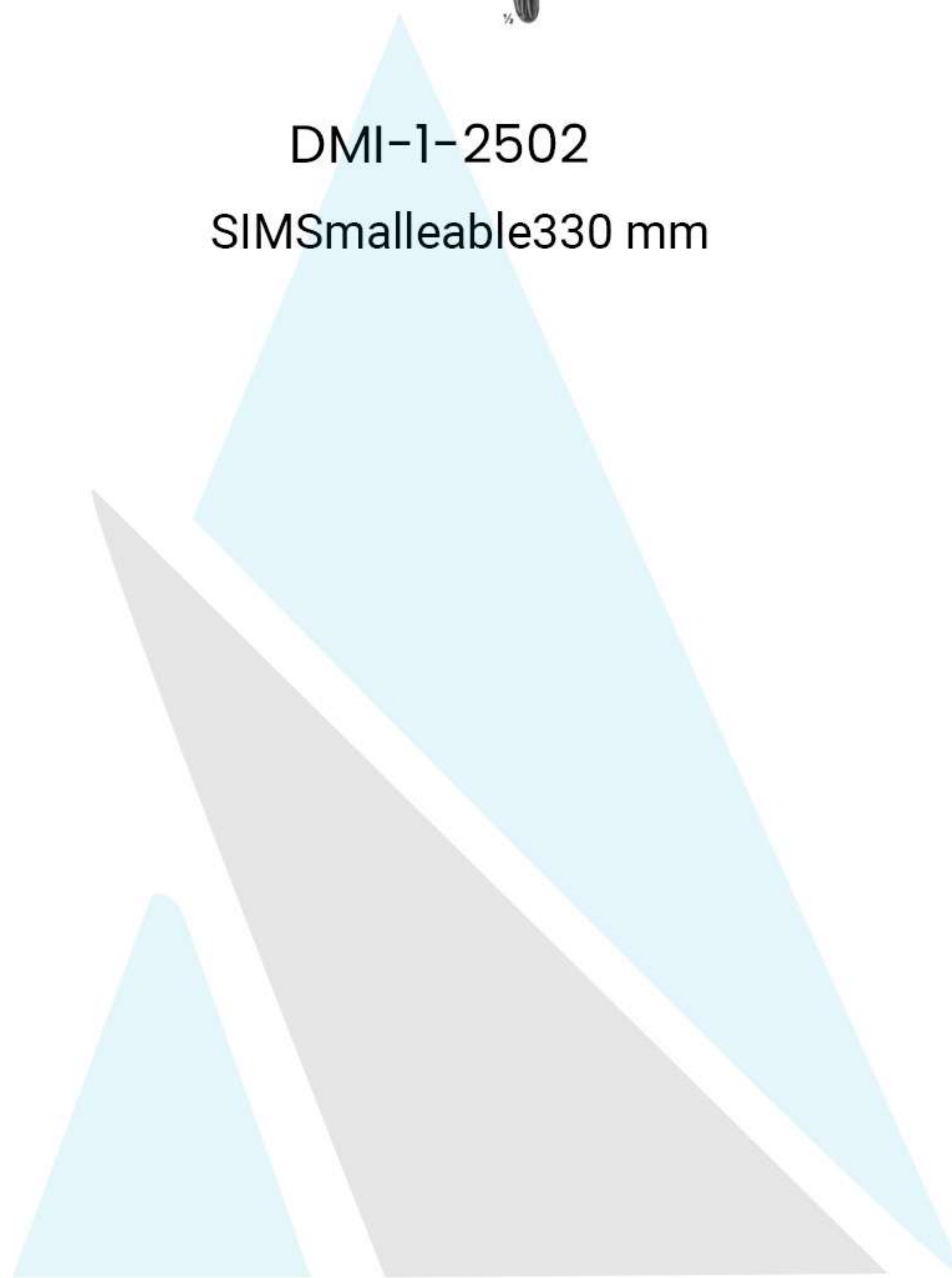

DMI-1-2504
SIMPSON malleable silver-plated 290 mm



DMI-1-2505
BRAUN Uterine depressor 270 mm



DMI-1-2506
Cotton applicator 270 mm

**Uterine Probes, Uterine Dressing,
Polypus and Ovum Forceps**



DMI-1-2507
PELKMANN260 mm



DMI-1-2508
PELKMANN260 mm



DMI-1-2509
BOZEMANN250 mm



DMI-1-2510
BOZEMANN255 mm Jaws with
longitudinal groove

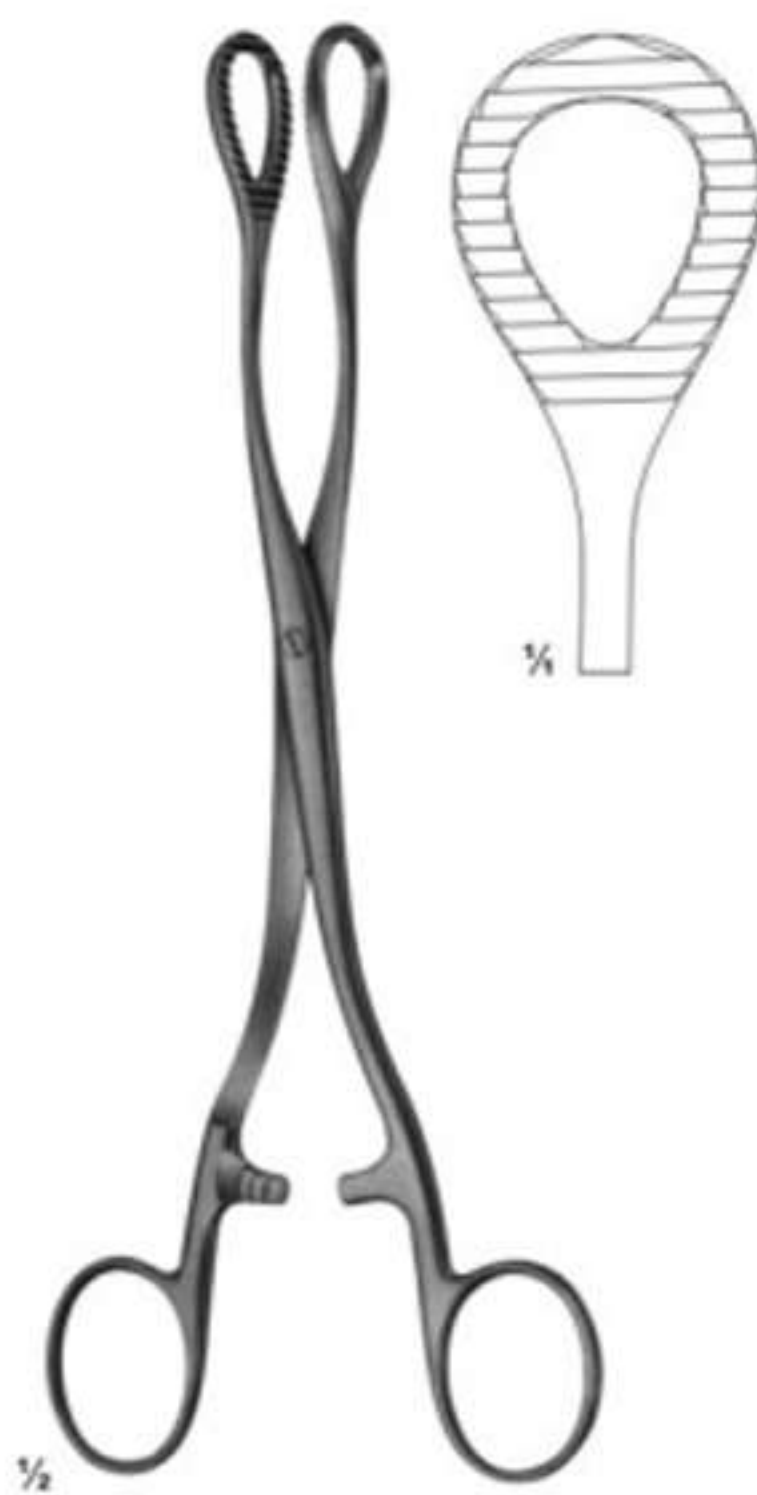

DMI-1-2511
HEYWOOD-SMITH200 mm

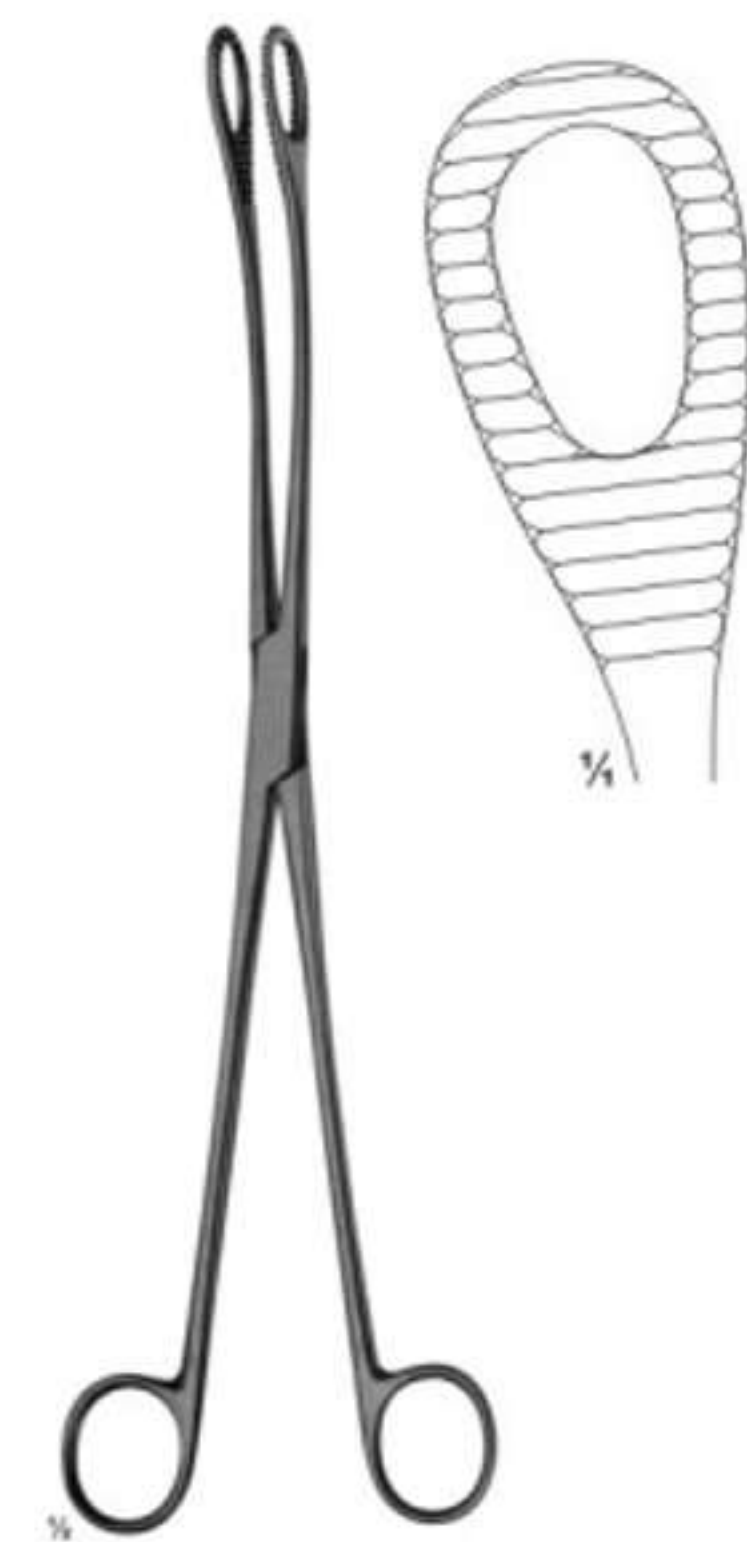

DMI-1-2512
KELLY320 mm

**Uterine Probes, Uterine Dressing,
Polypus and Ovum Forceps**

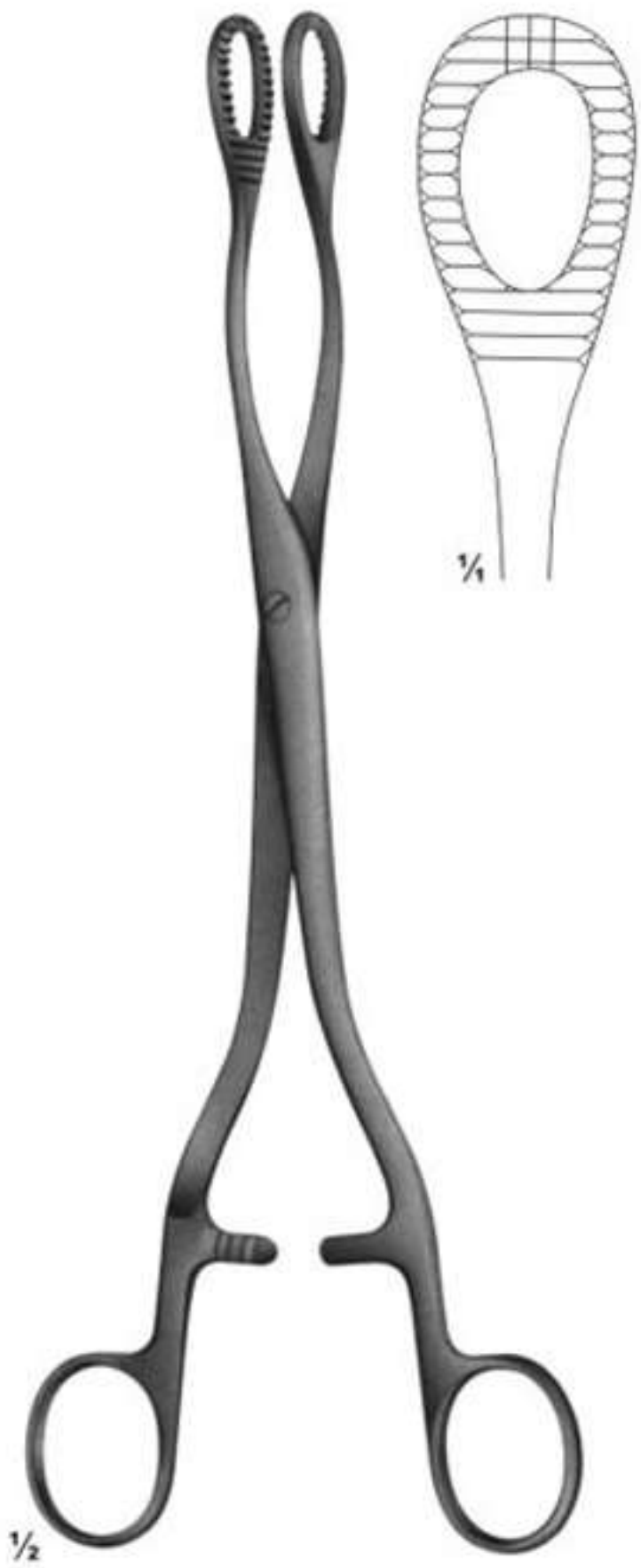

DMI-1-2513
HEYWOOD-SMITH 250 mm



DMI-1-2514
NOTO 280 mm



DMI-1-2601
Langenbeck
13 cm / 5 1/8"

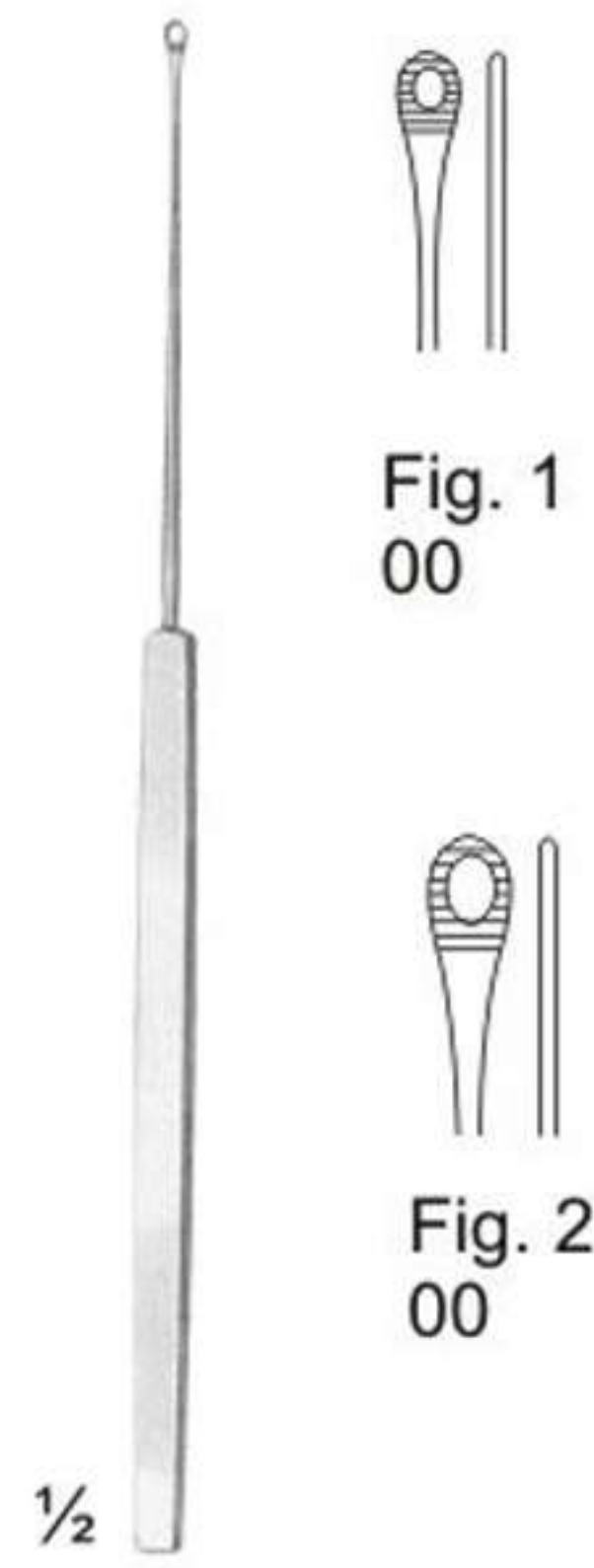

DMI-1-2602
Shapleigh
15 cm / 5 1/8" Fig. 100 Fig. 200

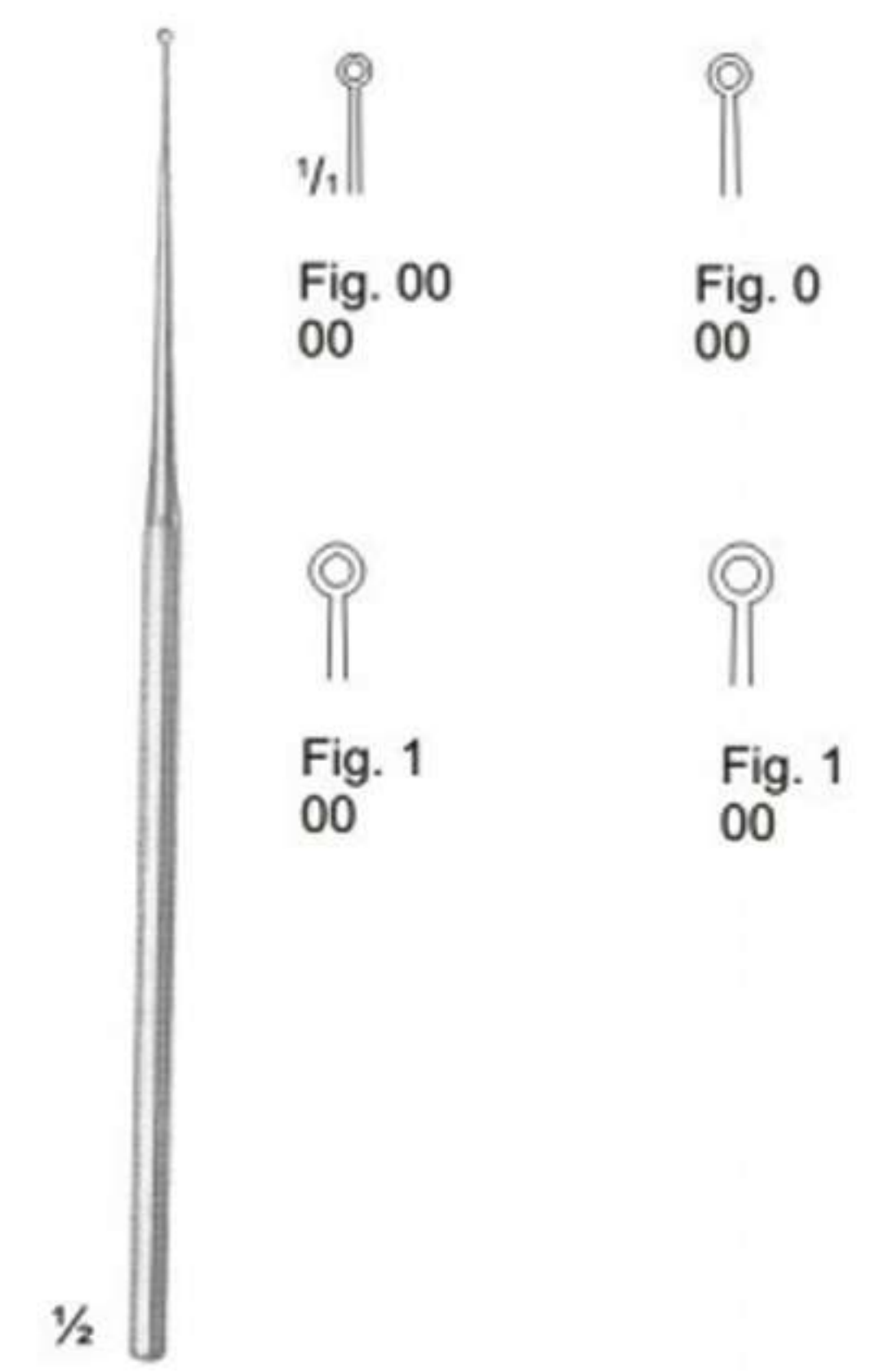

DMI-1-2603
Buck 12-103 Buck 17
17 cm / 6 6/8" Fig. 0000 Fig. 100 Fig. 100

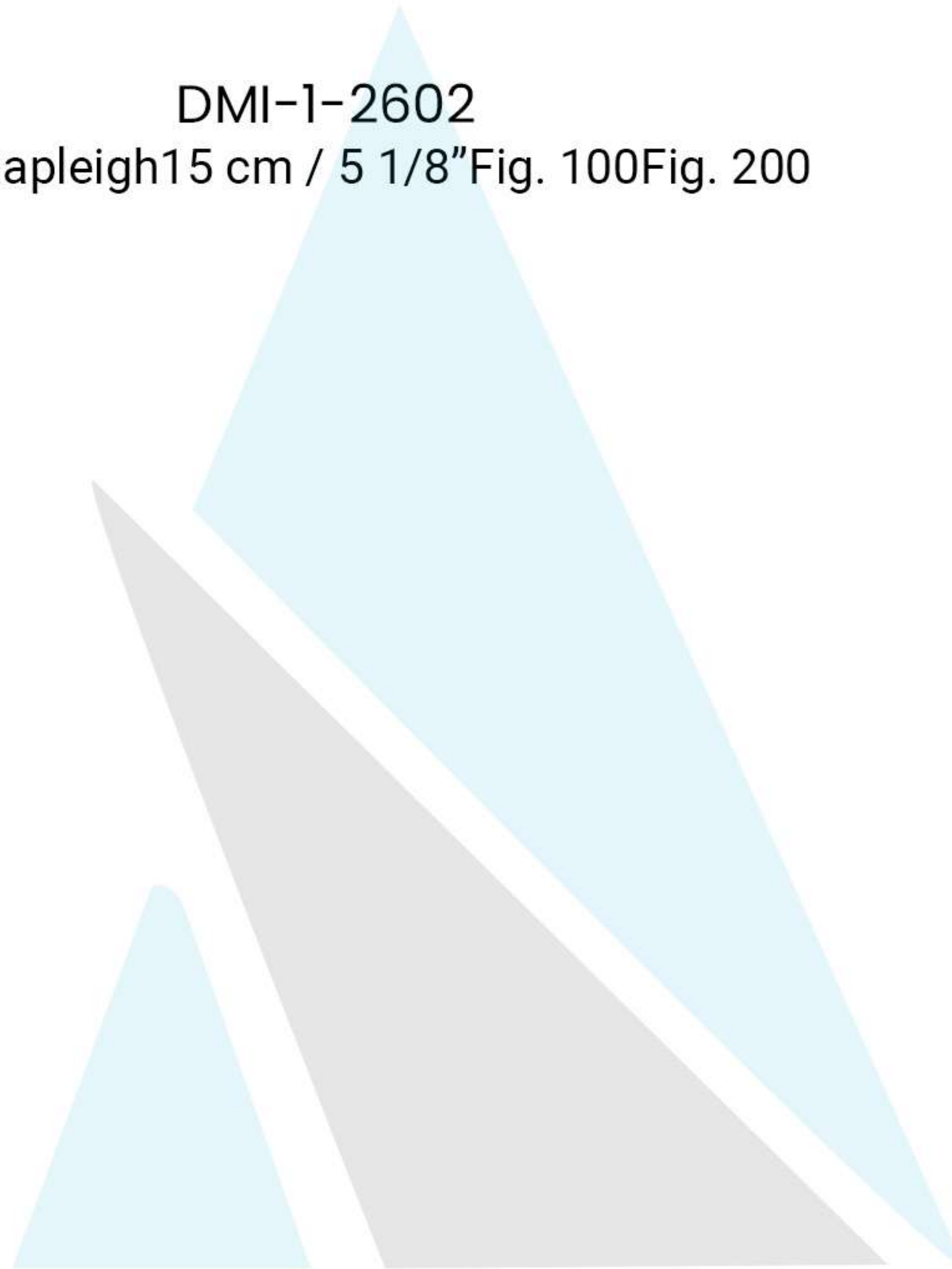

DMI-1-2604
Buck 12-104 Buck 15
15 cm / 6 6/8

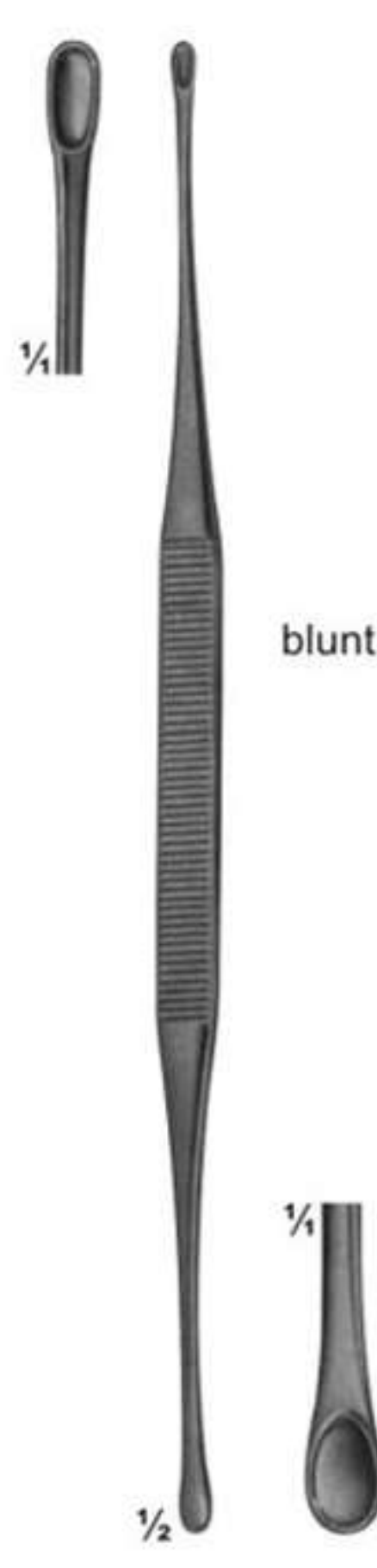

DMI-1-2605
ASCH Uterine Secretion scoop
200 mm



DMI-1-2606
Uterine Secretion scoop
270 mm



DMI-1-2607
NOVAK-SCHOECKAERT Endometrial
biopsy curette 240 mm



DMI-1-2608
RANDALL Endometrial biopsy
curette 240 mm

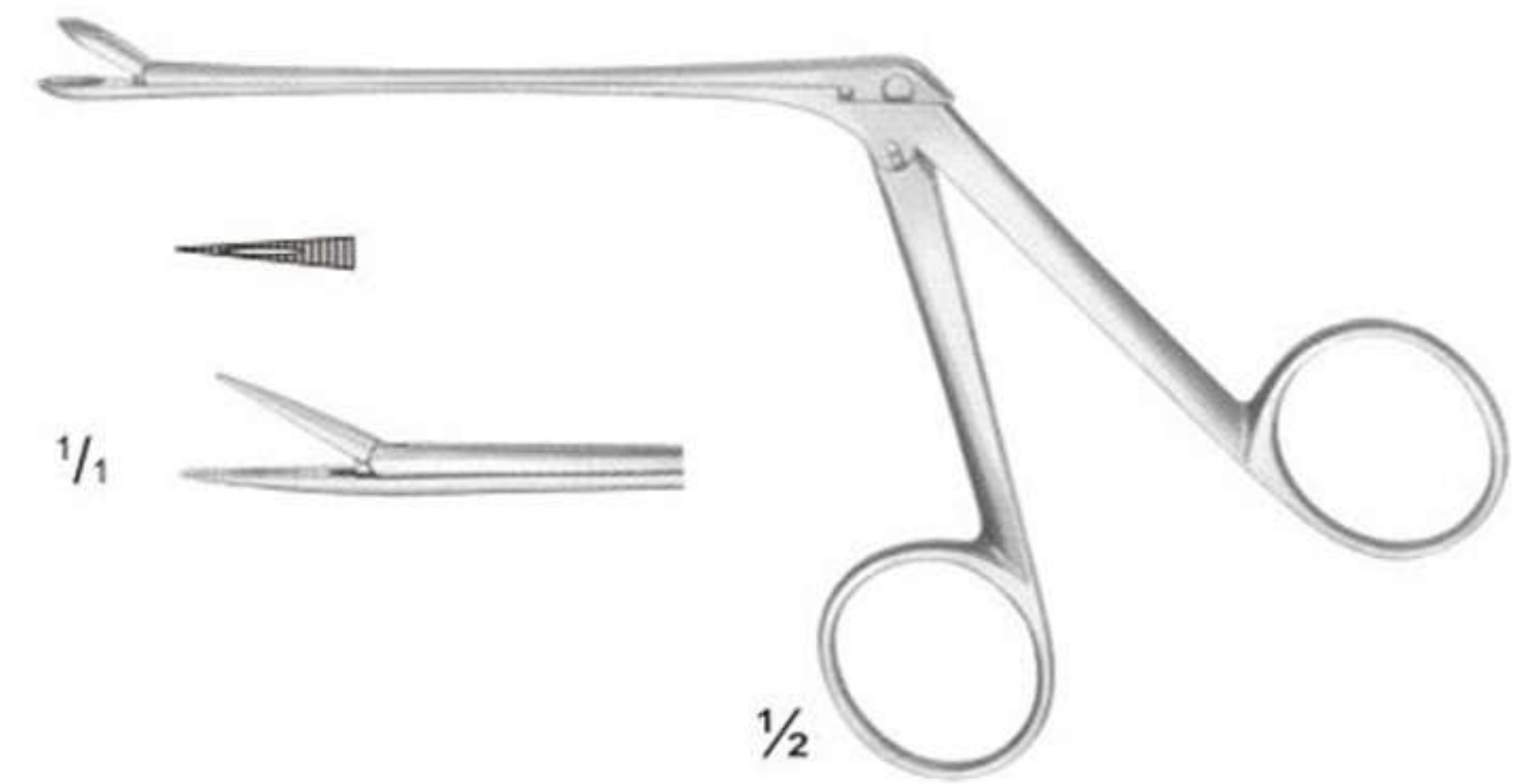

DMI-1-2609
Hartmann-Wullstein shaft length 85 mm

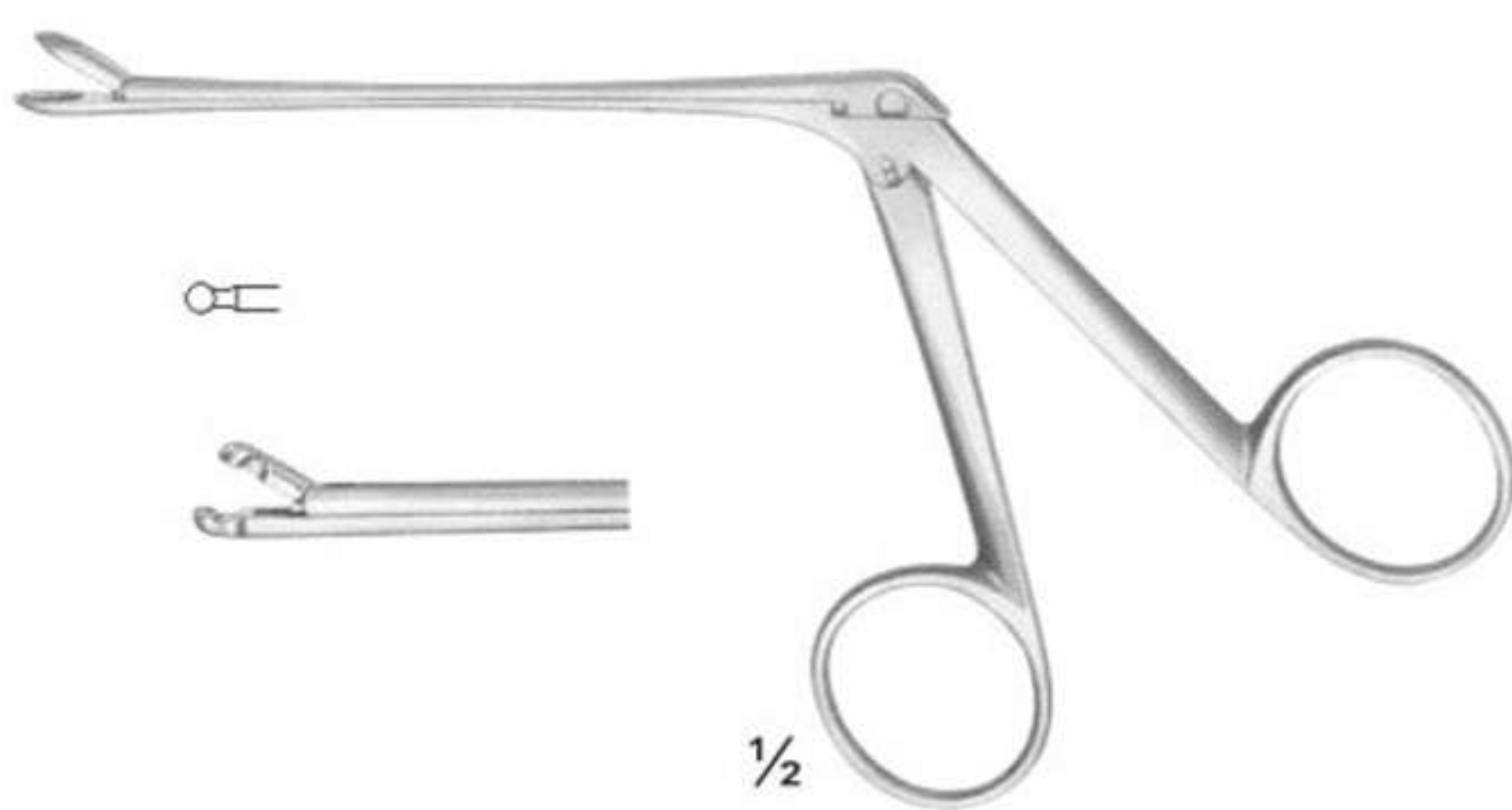

DMI-1-2611
Hartmann-Wullstein shaft
length 85 mm



DMI-1-2611
Hartmann shaft length 85 mm

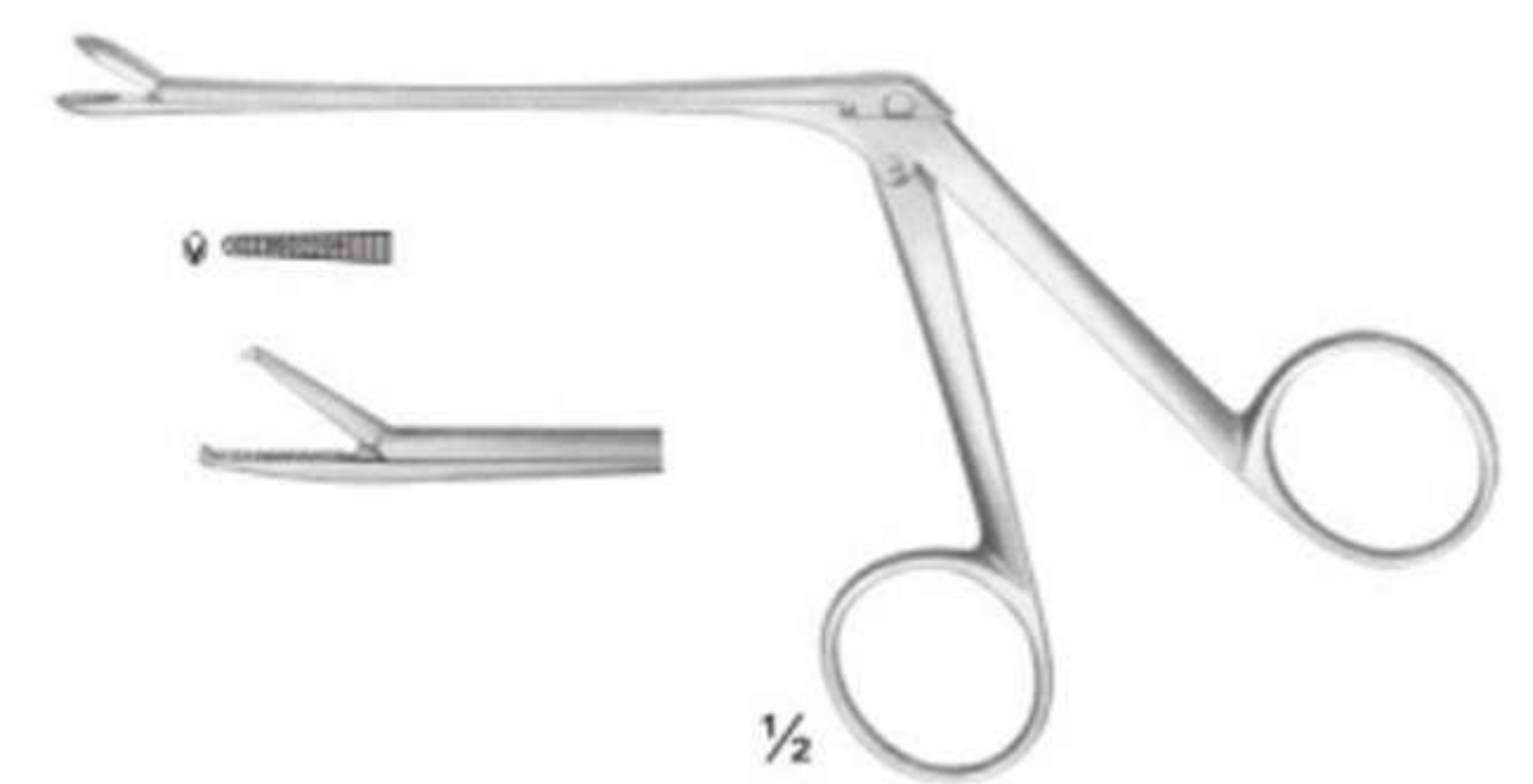

DMI-1-2612
Hartmann shaft length 85 mm

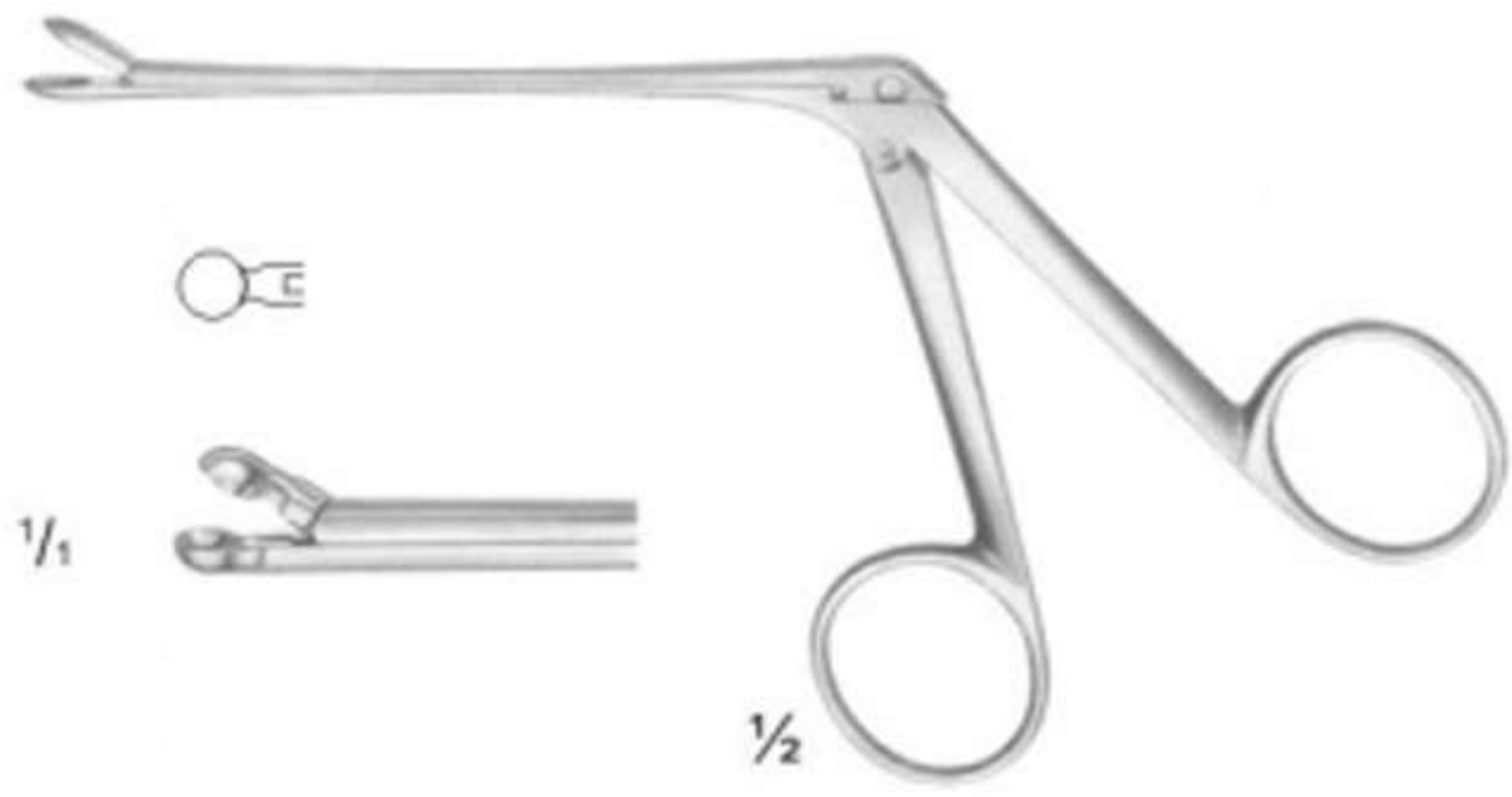

DMI-1-2613
14 cm / 5 4/8" shaft length 140 mm



DMI-1-2614
Hartmann-Herzfelr 2,0 mm shaft length 85mm

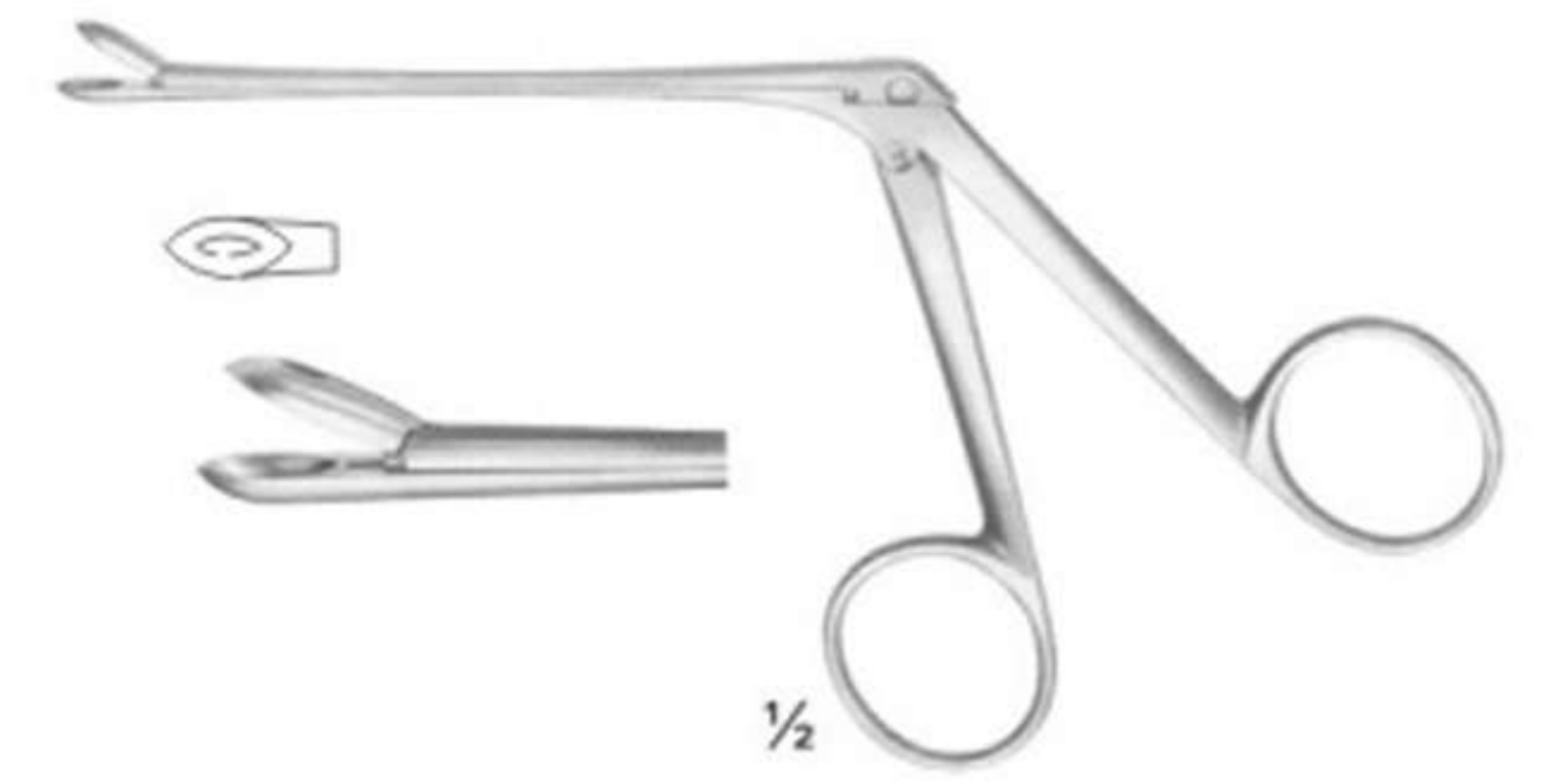

DMI-1-2615
Hartmann 3 mm shaft length 85mm

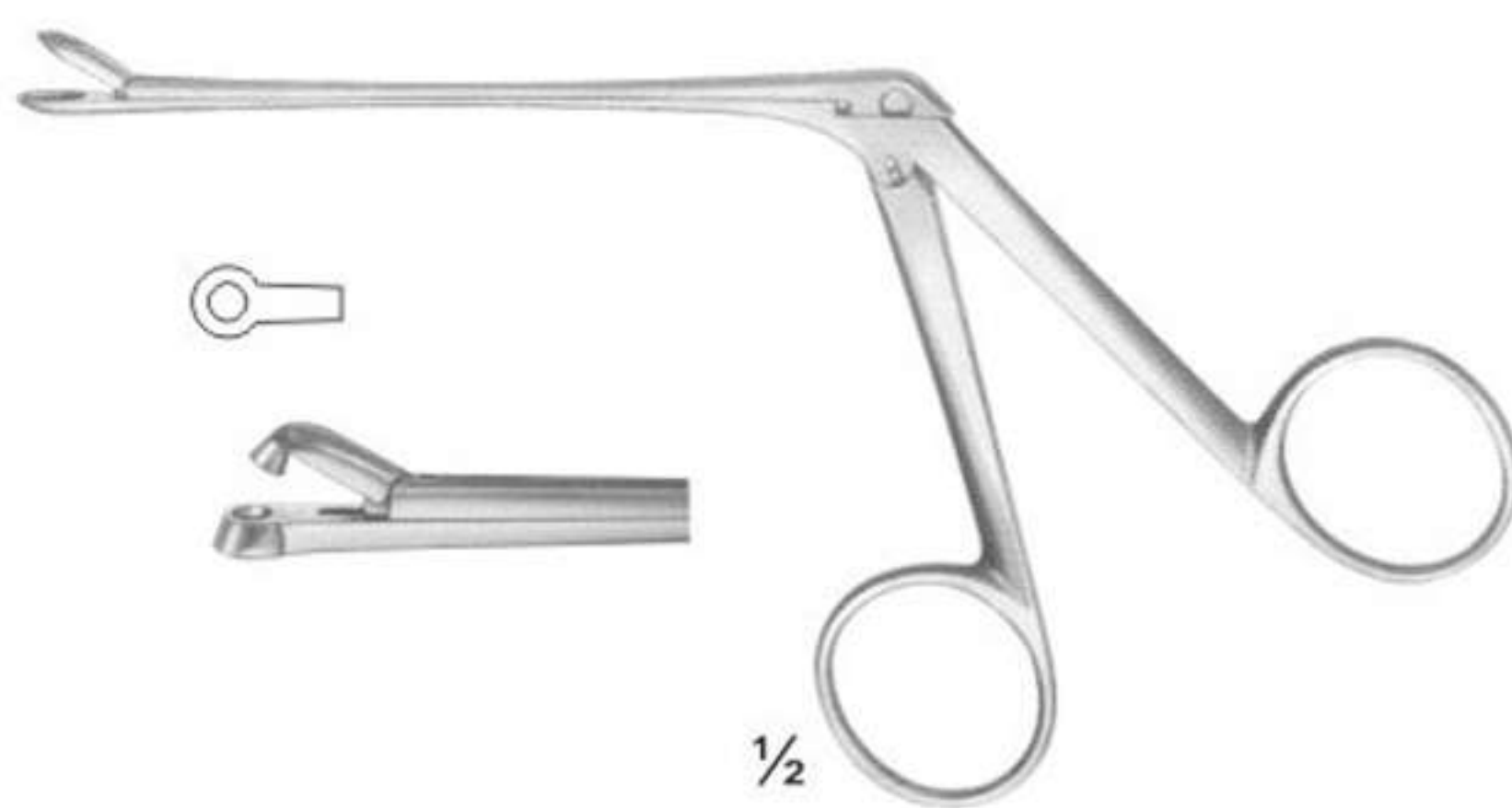
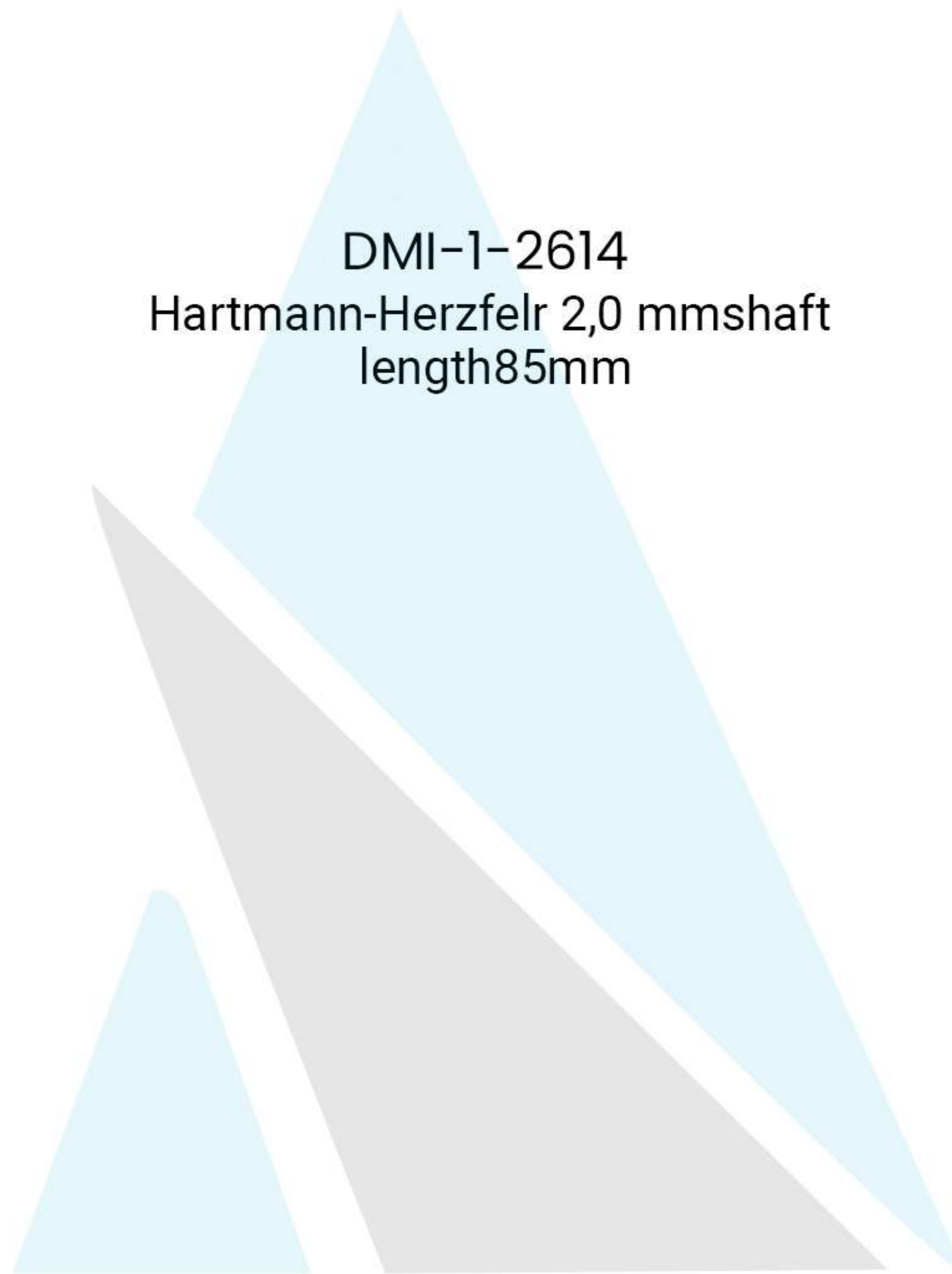

DMI-1-2616
shaft length 85mm

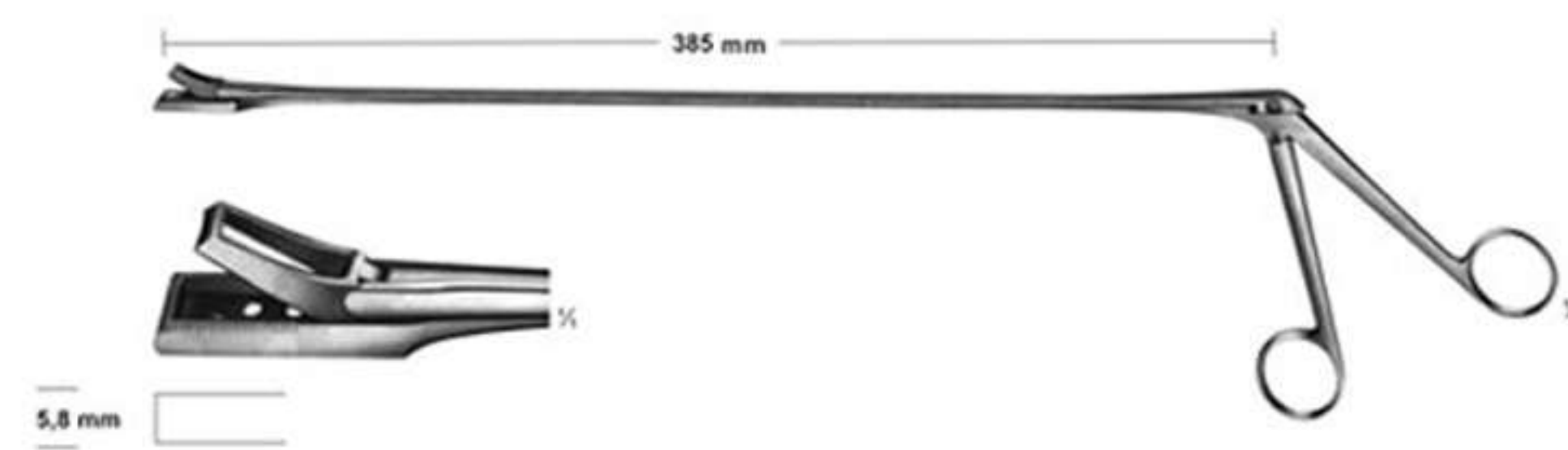

DMI-1-2617
385 mm

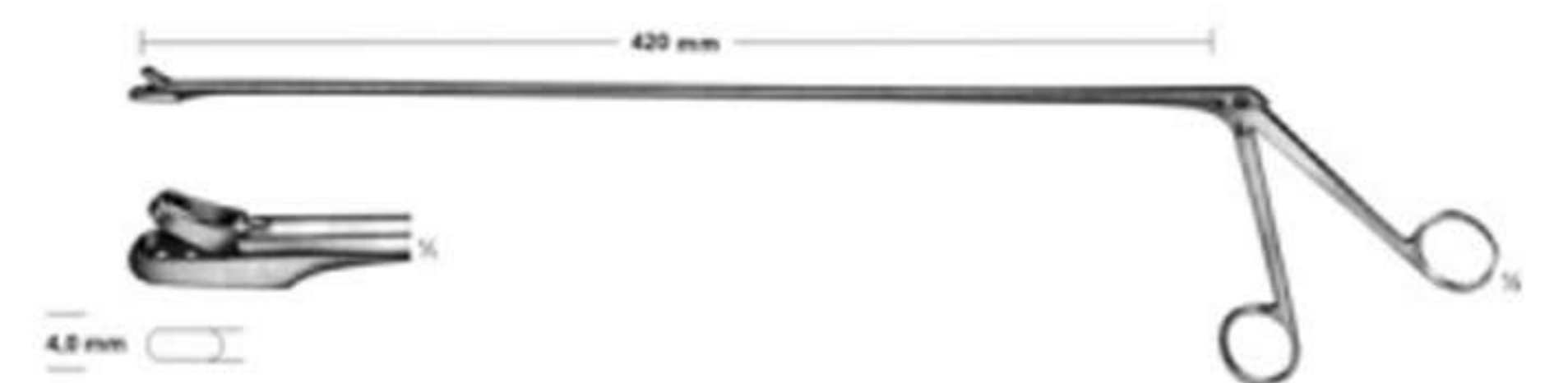

DMI-1-2618
YEOMAN 420 mm



DMI-1-2619
HERGET 380 mm

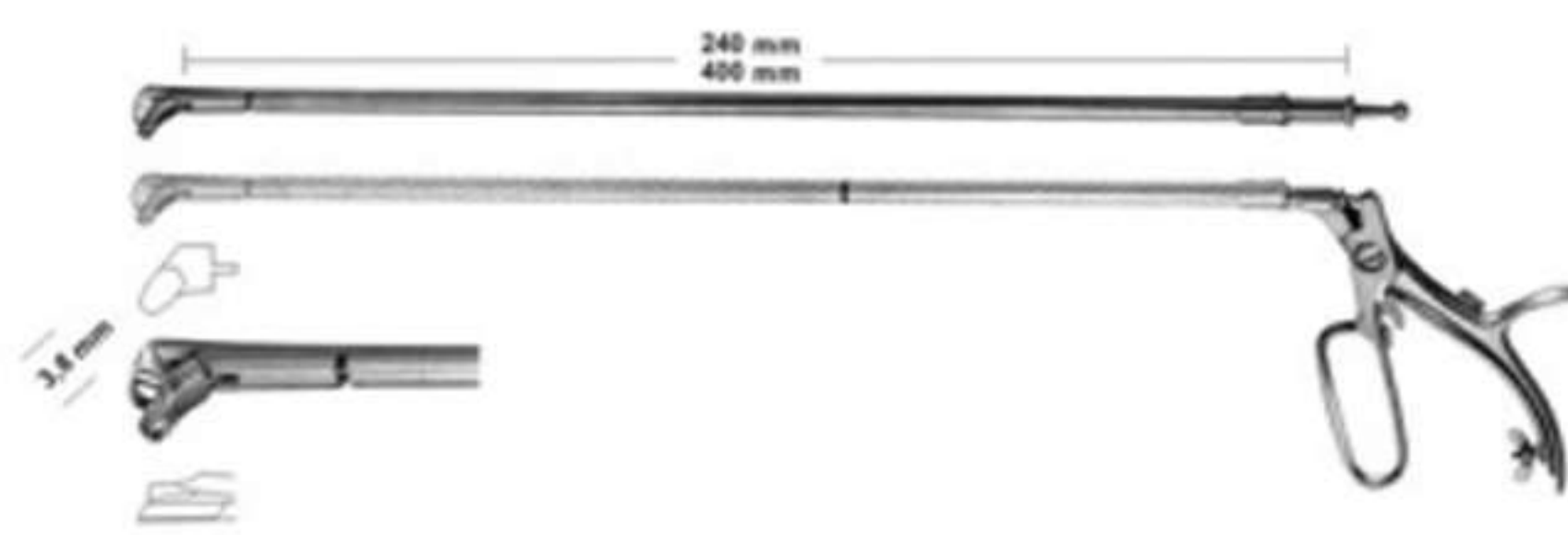

DMI-1-2620
Turnable 240 mm

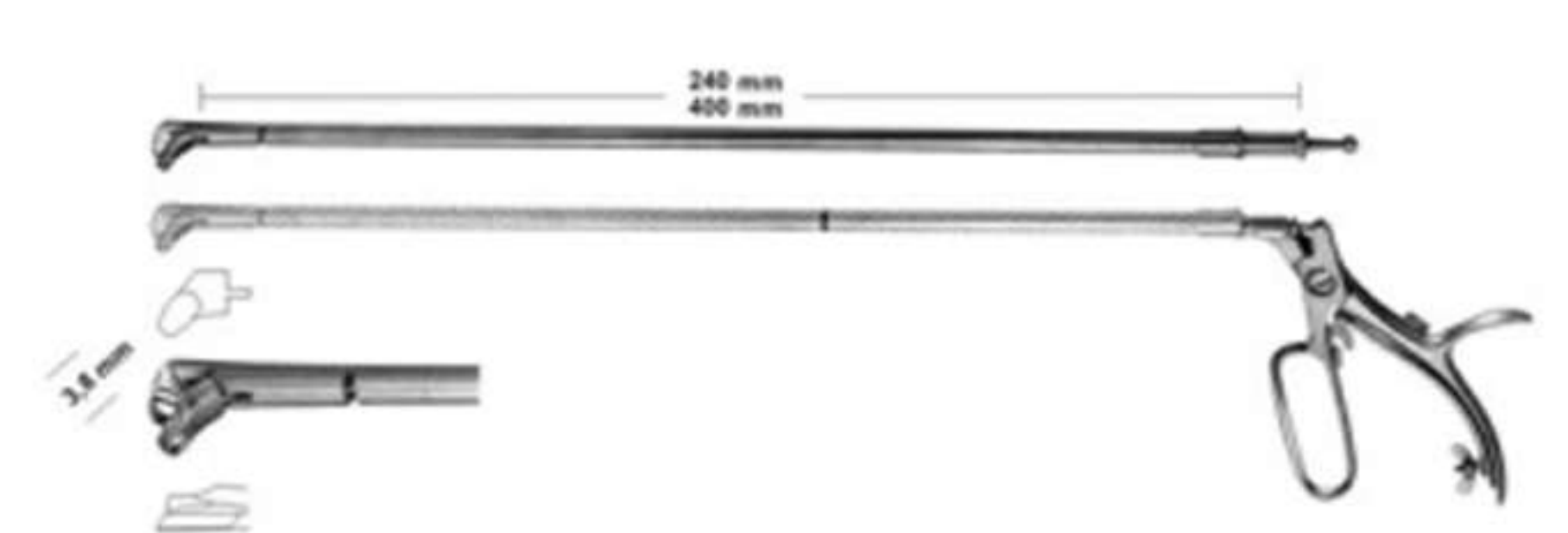

DMI-1-2621
Turnable 400 mm

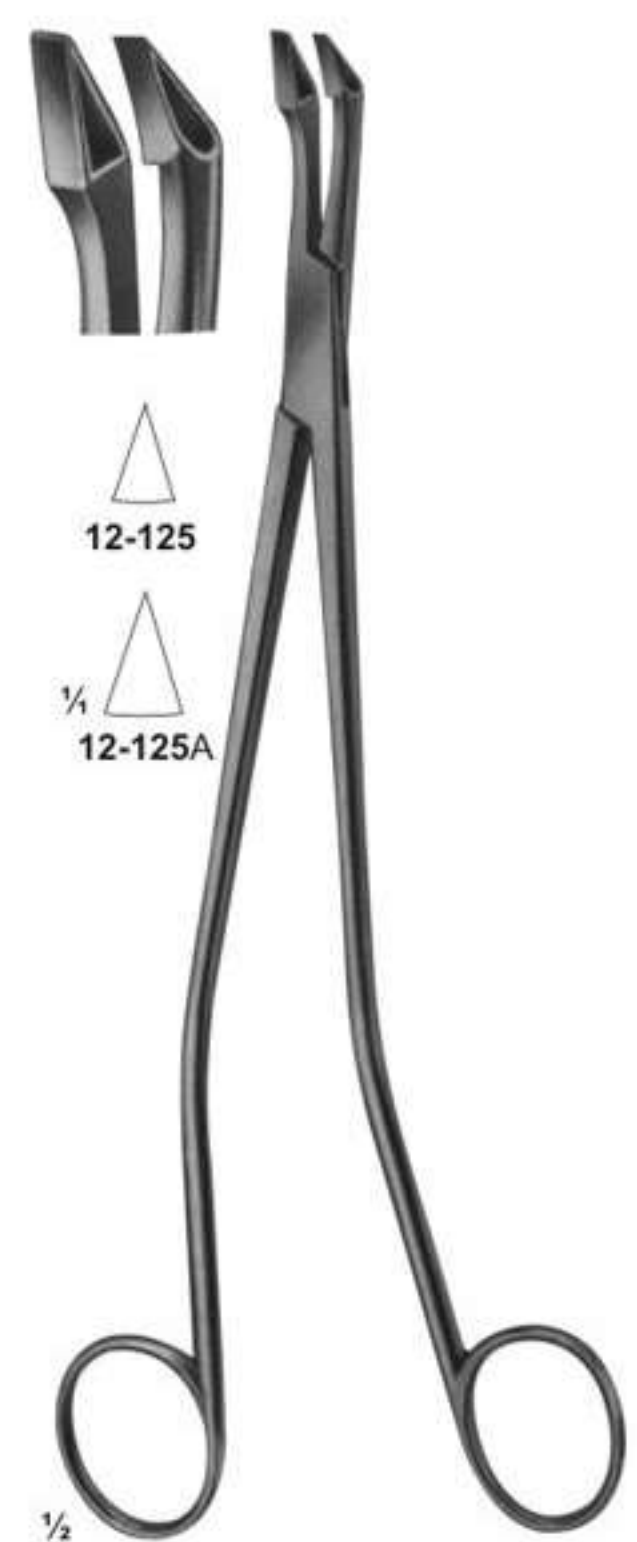

DMI-1-2622
SCHUMACHER 240mm

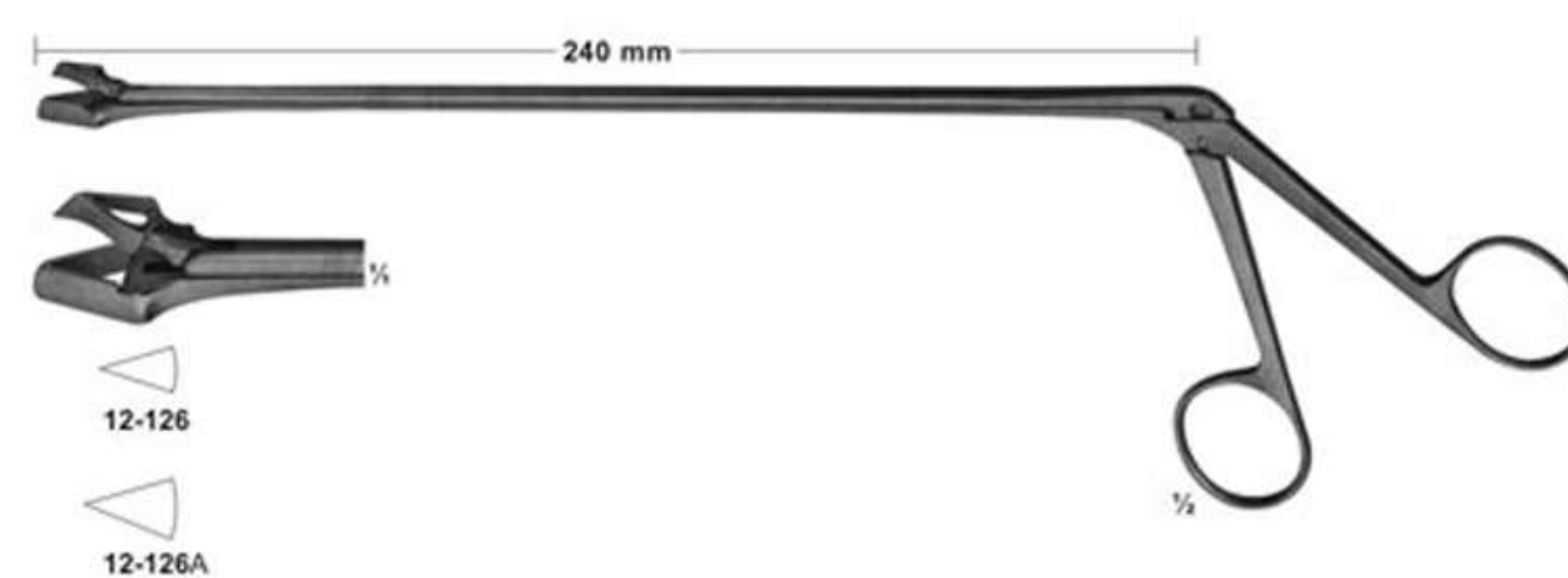

DMI-1-2623
SCHUMACHER suitable for colposcopy

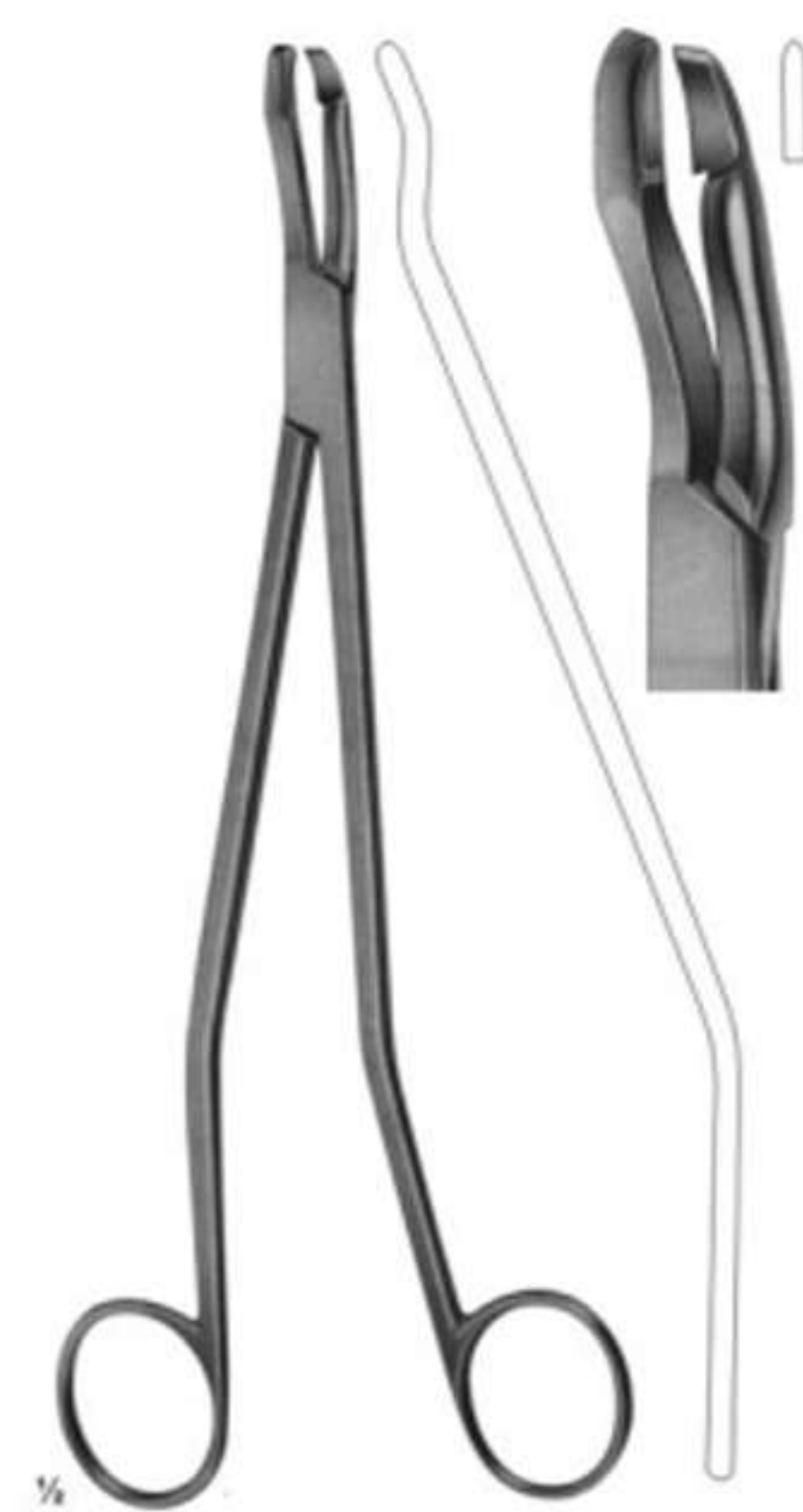

DMI-1-2624
SEIDL DBP Biopsy forceps, bayonet
shaped for portio, vagina and vulva 240mm

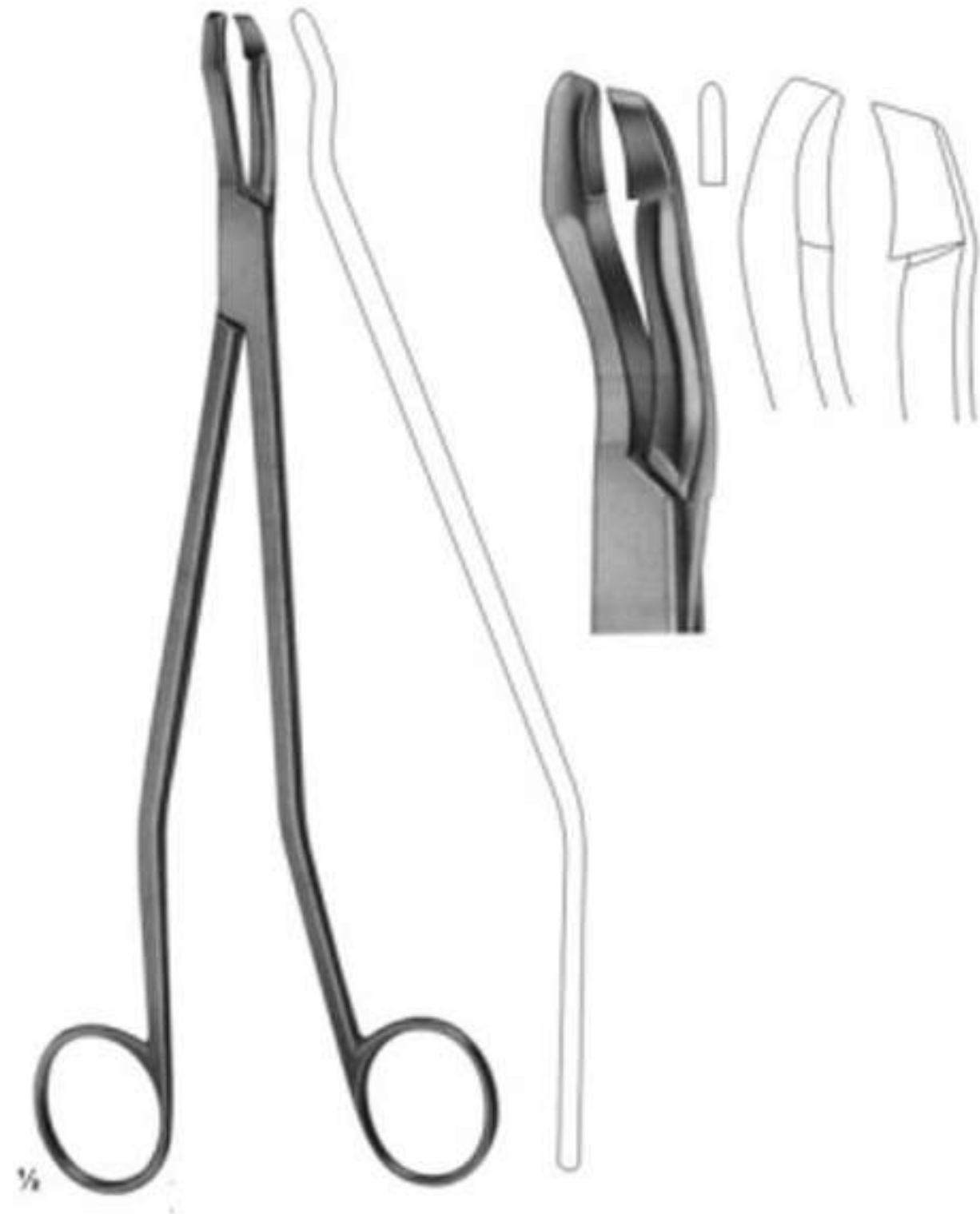

DMI-1-2625
SEIDL DBP Biopsy forceps, bayonet
shaped for portio, vagina and
vulva 240mm

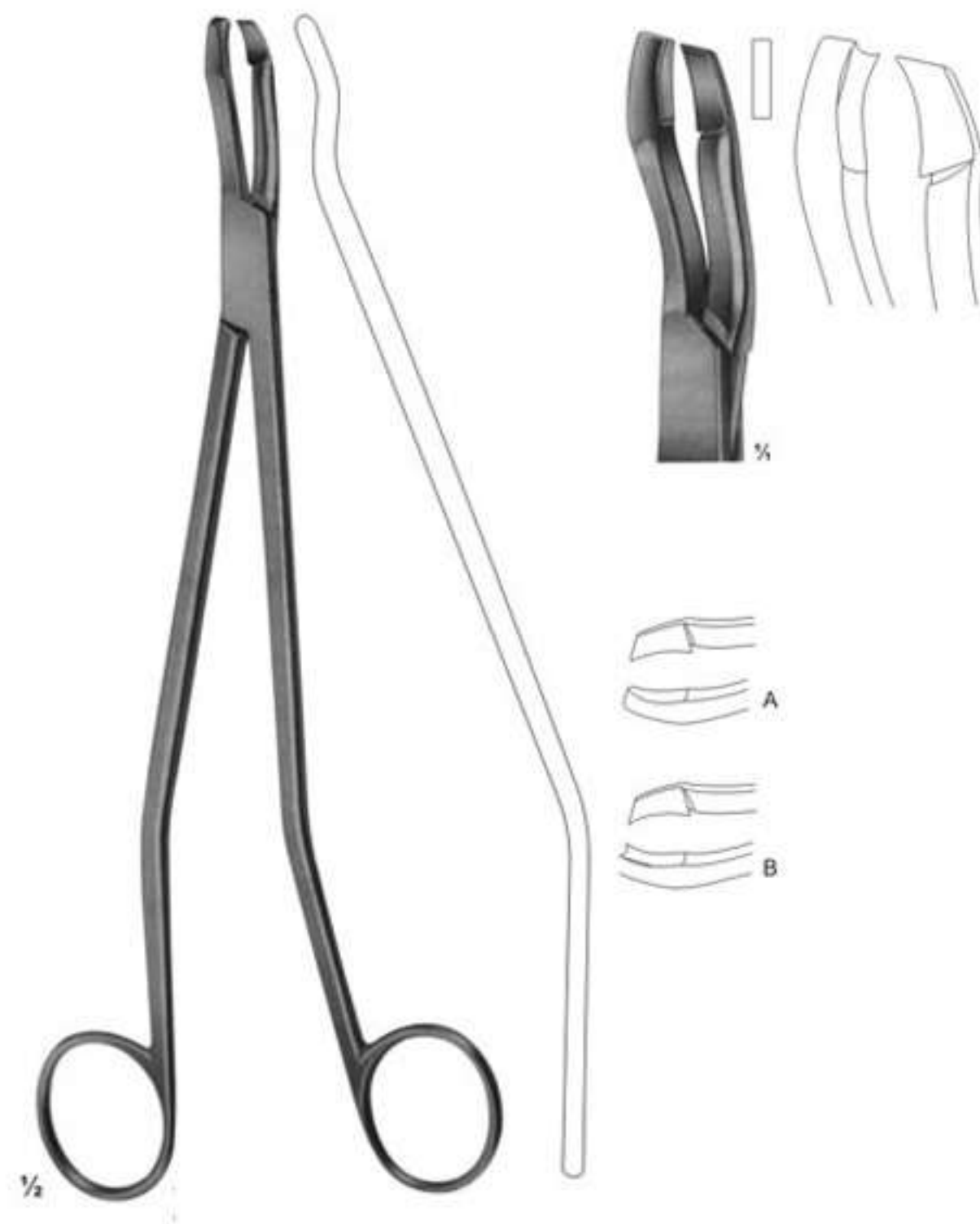

DMI-1-2626
SEIDL DBP Biopsy forceps, bayonet
shaped for portio, vagina and
vulva 240mm

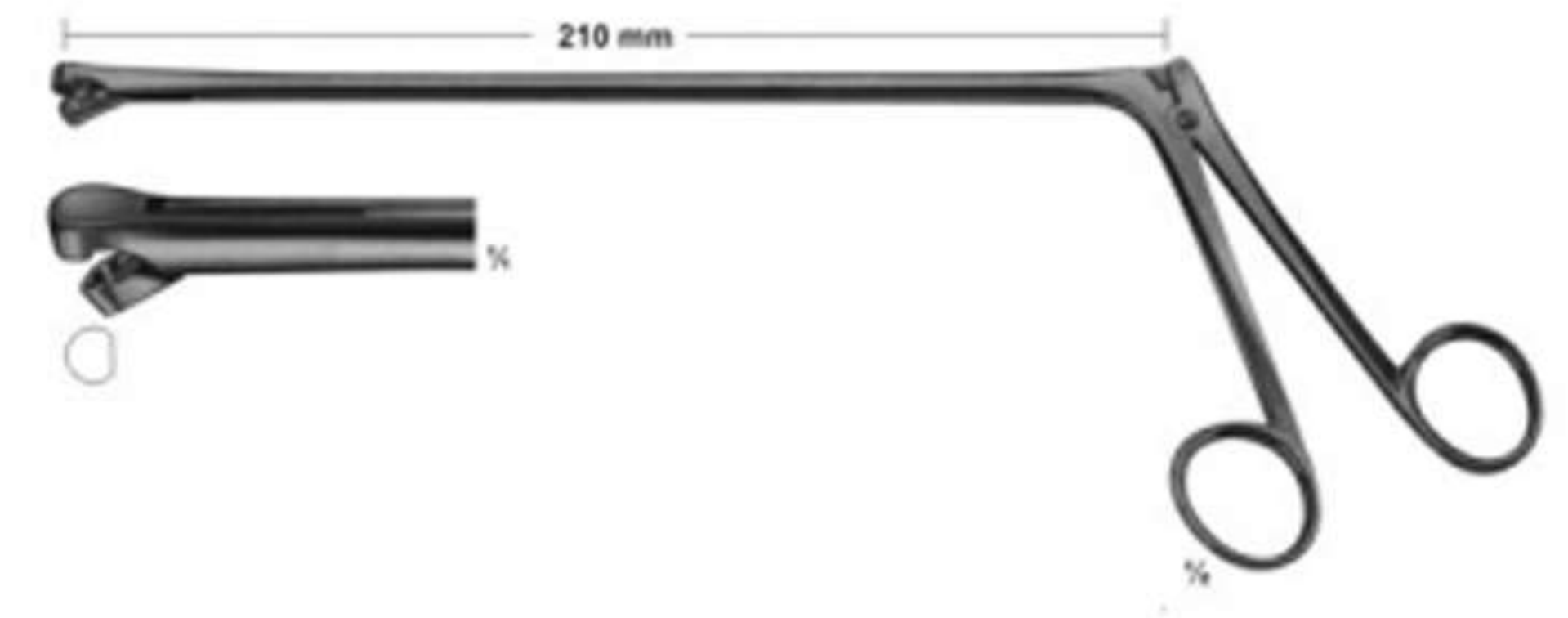

DMI-1-2627
BERGER

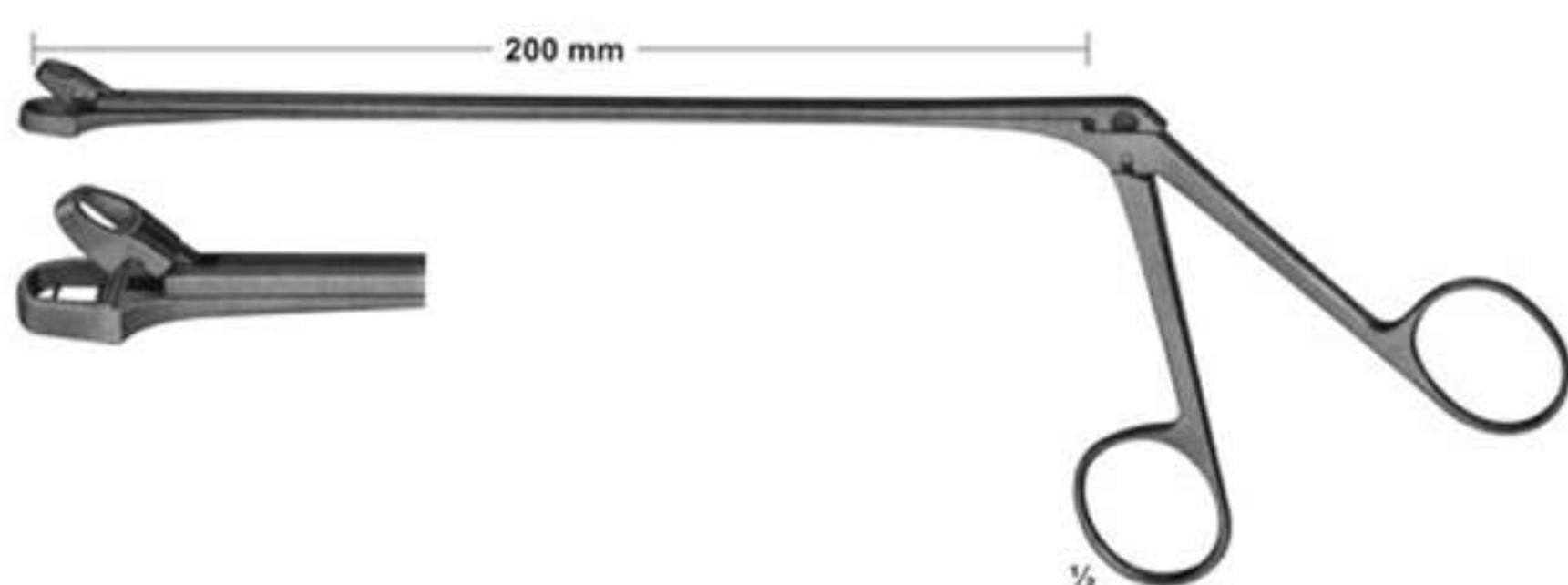

DMI-1-2628
EPPENDORF
250 mm

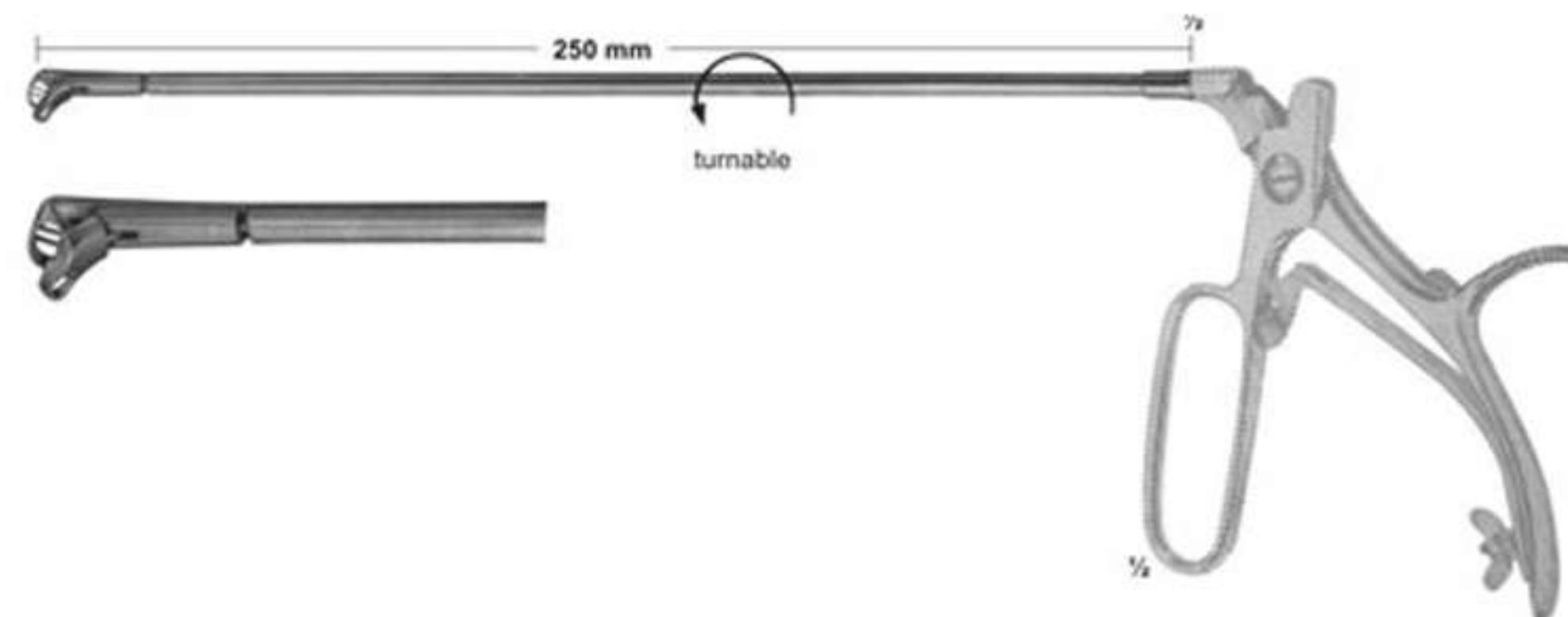

DMI-1-2629
Biopsy Instruments and Curettes



DMI-1-2630
AESCULAP 140 mm



DMI-1-2631
HUBER140 mm



DMI-1-2632
BRUENINGS



DMI-1-2633
BRUENINGS

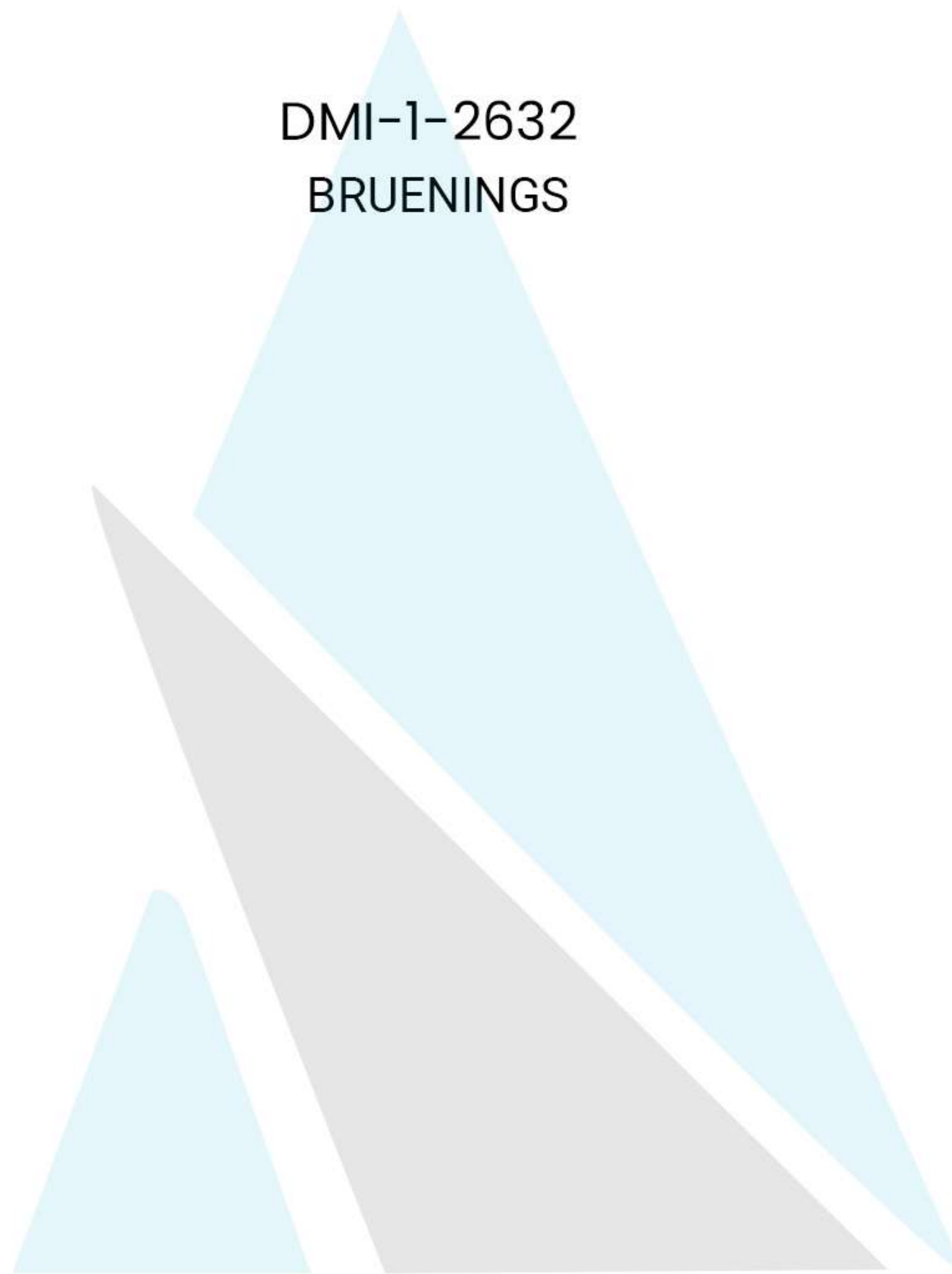

DMI-1-2634
KRAUSE (Biopsy tip)



DMI-1-2635
SCHEINMANN



DMI-1-2636
SCHUMACHER (Biopsy tip)
12-139 SCHUMACHER (Biopsy tip)
with drawing cut



DMI-1-2637
SIMON 240 mm



DMI-1-2638
SCHROEDER 310 mm

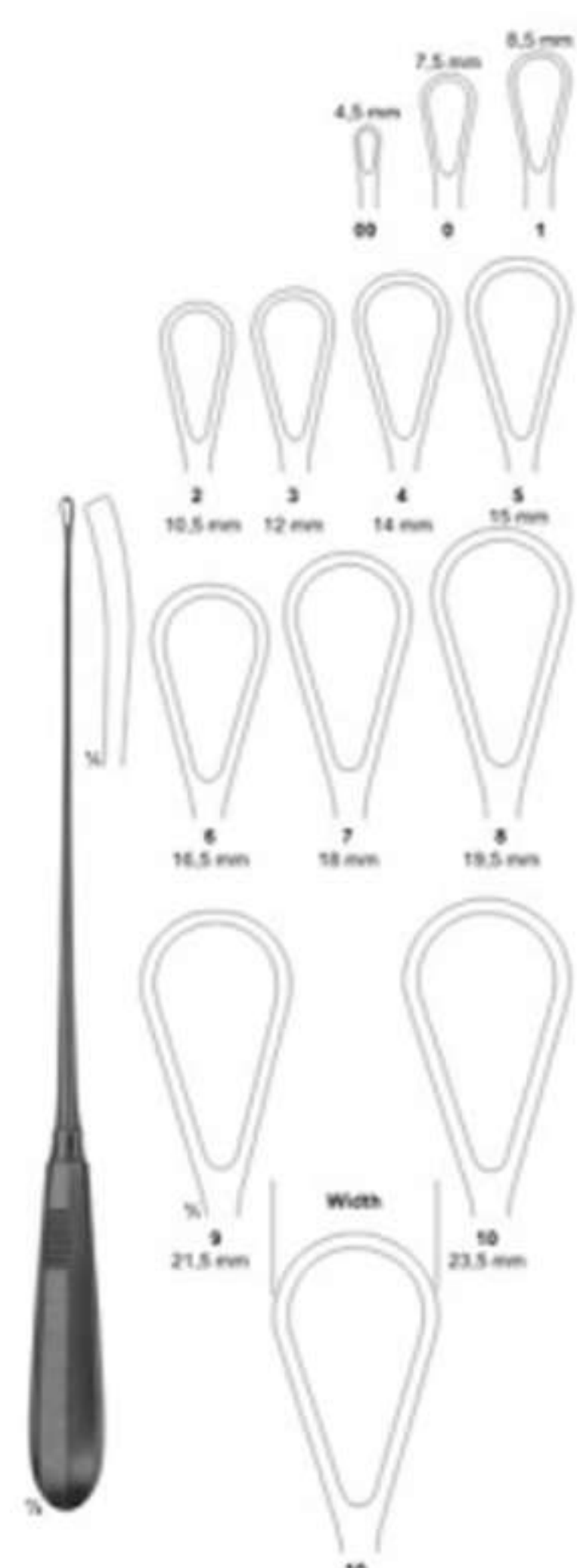

DMI-1-2639
RECAMIER 300 mm





DMI-1-2701
NAEGELE 355 mm



DMI-1-2702
NAEGELE 400 mm



DMI-1-2703
SIMPSON-BRAUN305mm

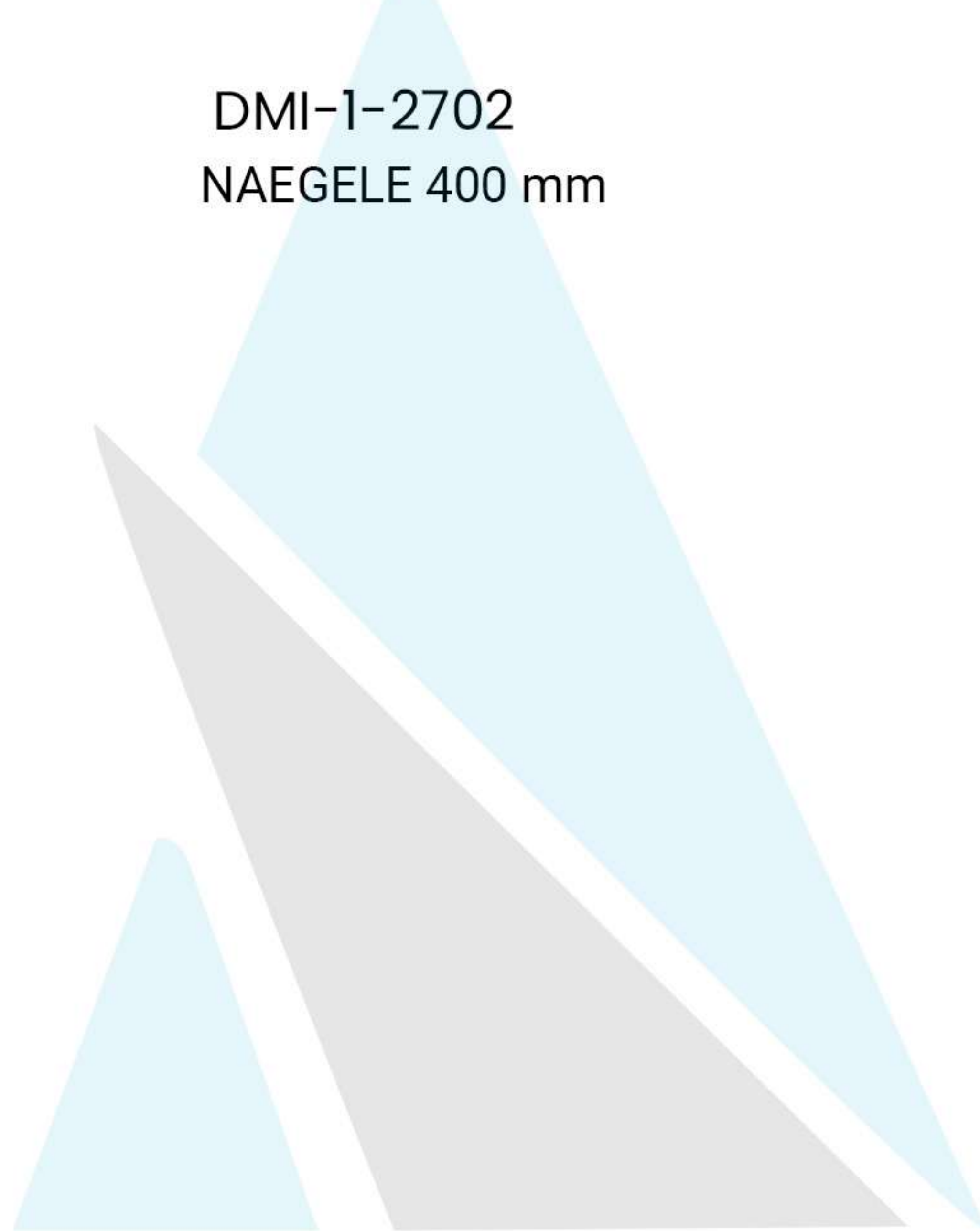

DMI-1-2704
WINTER290 mm



DMI-1-2705
WINTER290 mm



DMI-1-2706
WINTER290 mm



DMI-1-2707
WINTER 290 mm



DMI-1-2708
WINTER 290 mm



DMI-1-2709
WINTER 290 mm



DMI-1-2710
SAENGER 275 mm

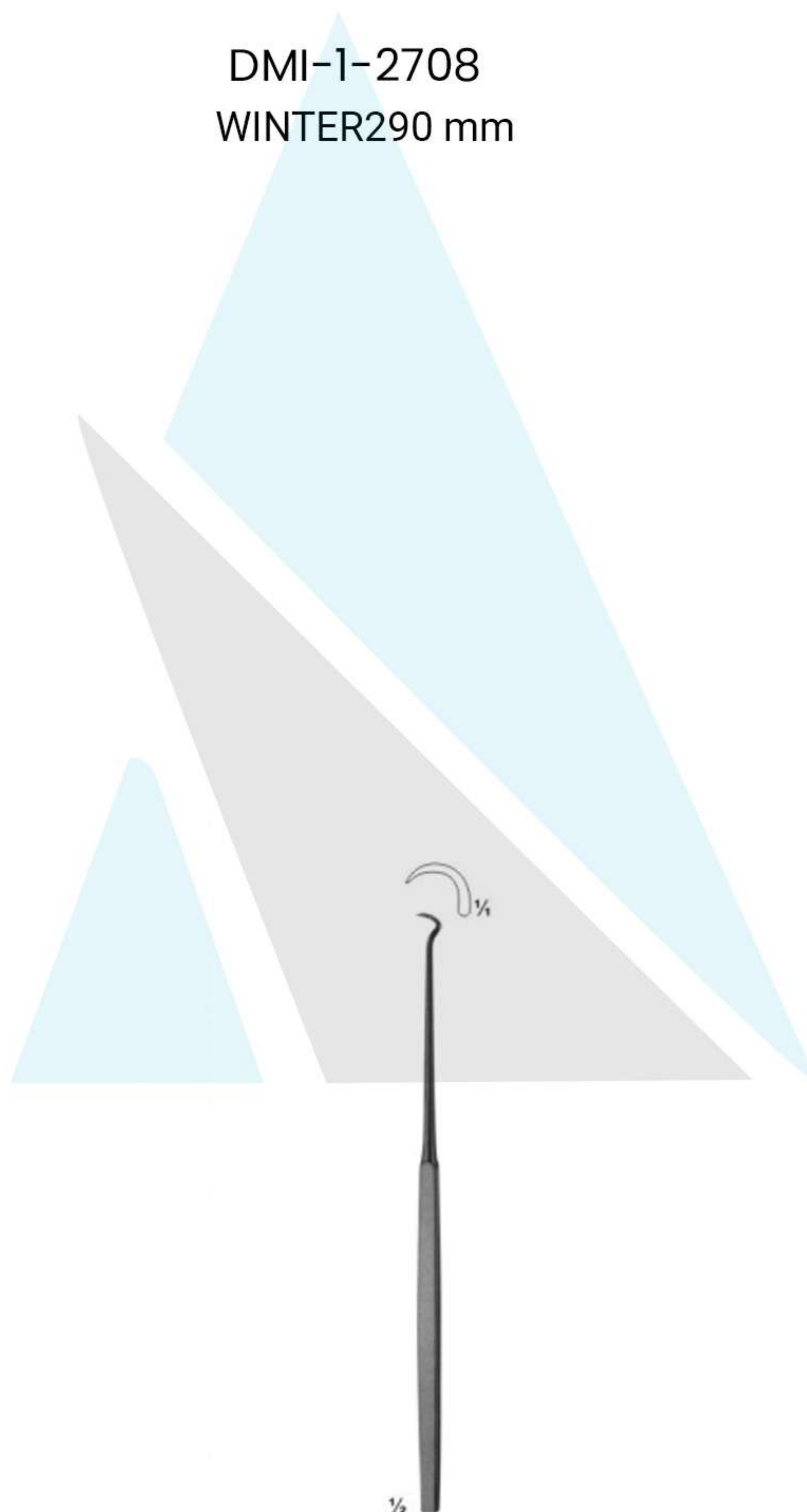

DMI-1-2711
BOSE 165 mm



DMI-1-2712
180 mm Sharp



DMI-1-2713
180 mm Sharp



DMI-1-2714
180 mm Blunt



DMI-1-2715
180 mm stump/blunt

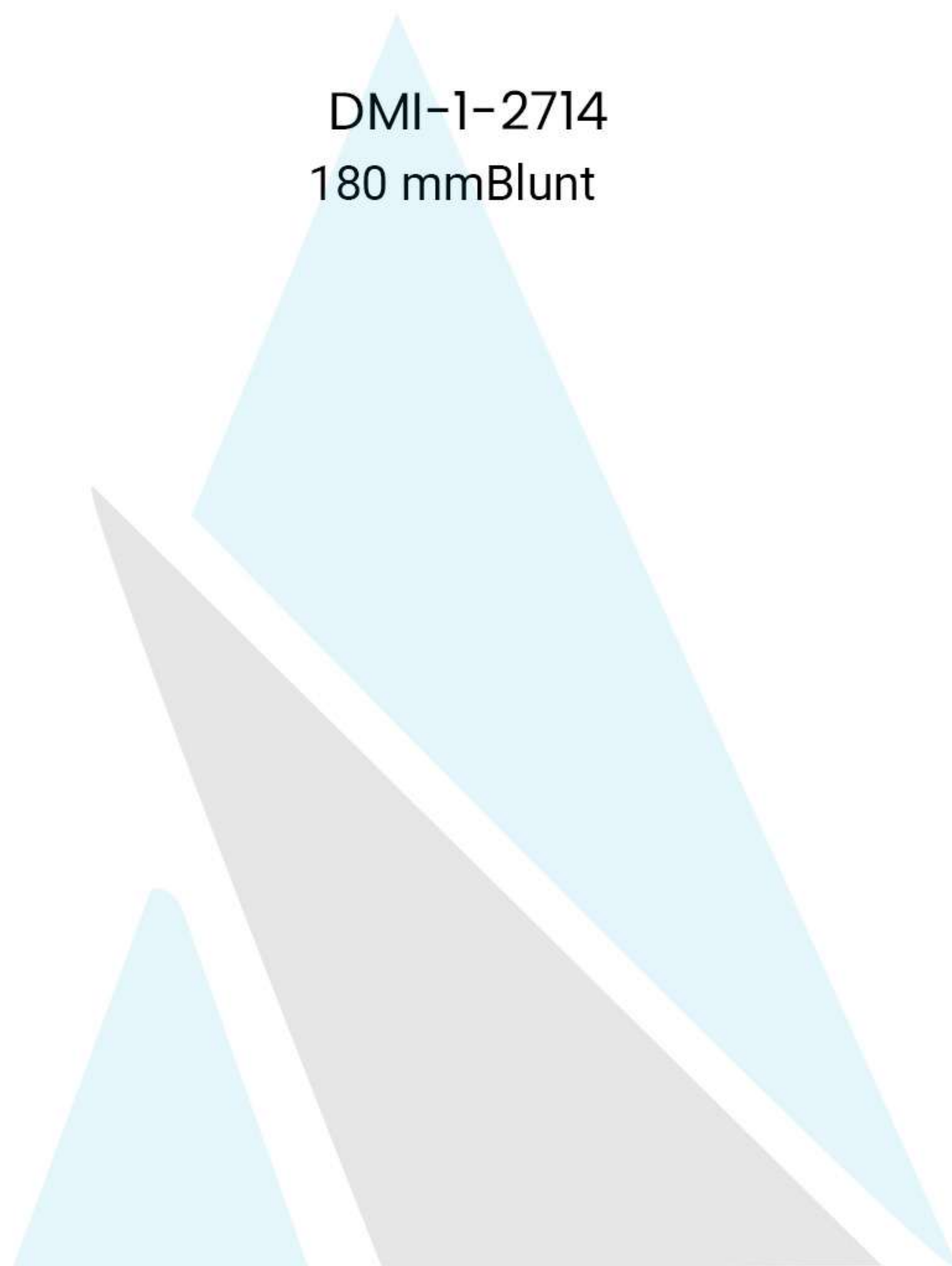

DMI-1-2716
FINSEN 50 mm



DMI-1-2717
FINSEN 70 mm



DMI-1-2718
TROUSSEAU 120 mm



DMI-1-2719
LABORDE125 mm



DMI-1-2720
LABORDEstrong pattern135 mm



DMI-1-2721
Cleaning Brush for tracheal tubes285 mm



DMI-1-2801
185 mm 215 mm



DMI-1-2802
230 mm



DMI-1-2803
HALLE 180 mm



DMI-1-2804
FREER sharp/blunt 185 mm



DMI-1-2805
FREER sharp/blunt 185 mm



DMI-1-2806
DAVIS 245 mm

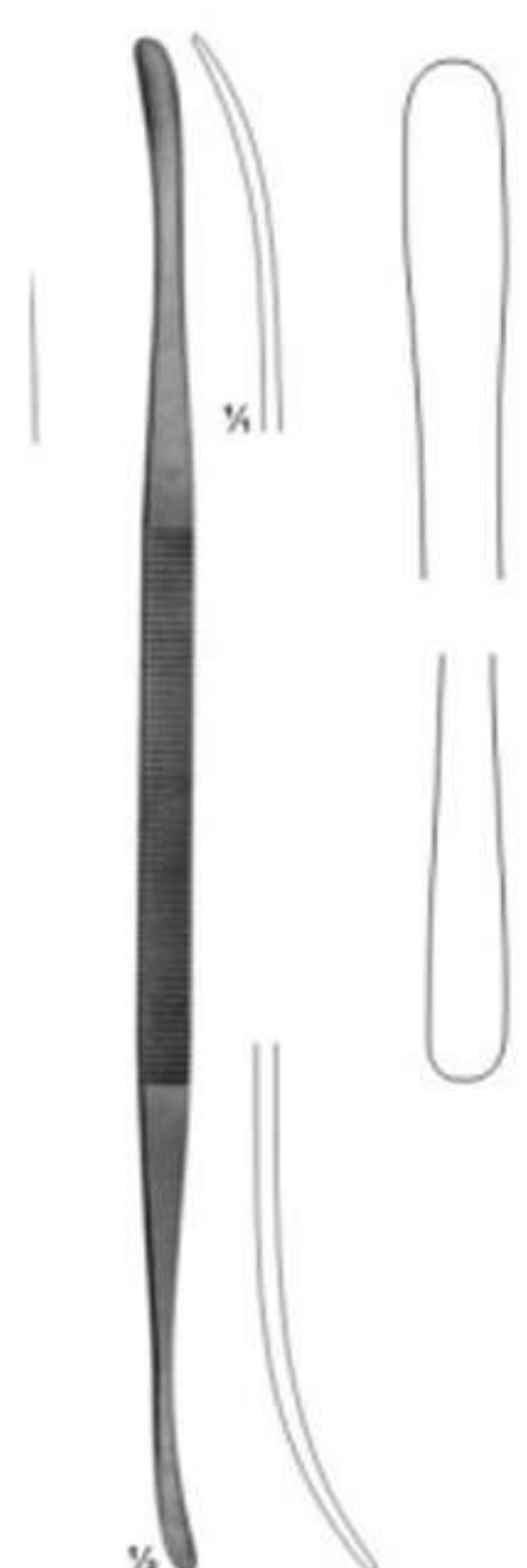

DMI-1-2807
DAVIS 245 mm

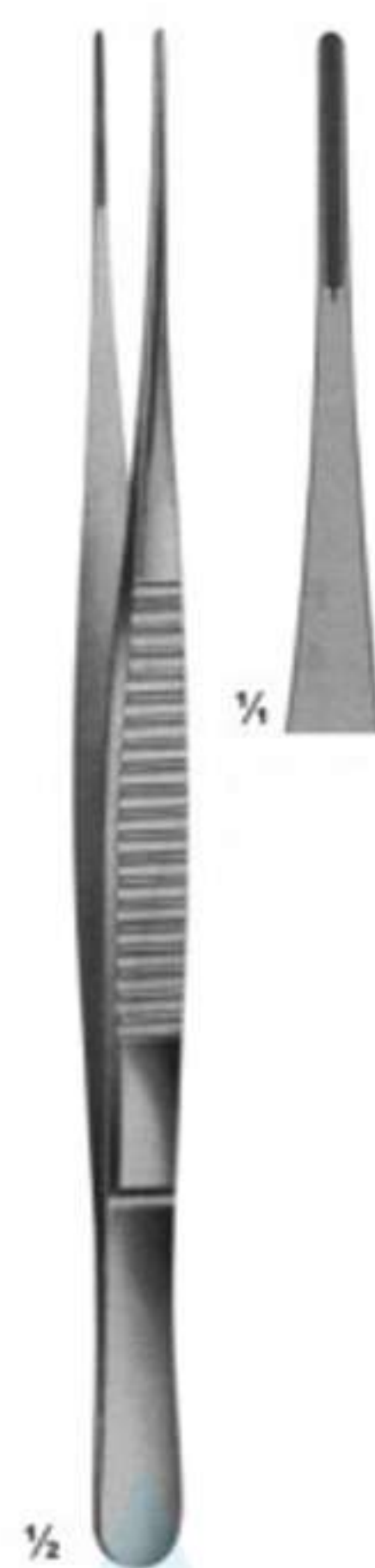

DMI-1-2808
DE BAKLEY 150 mm 200 mm



DMI-1-2809
DE BAKLEY 14-113 14-114 14-115 14-116
2 mm 2 mm 2 mm 2 mm 150 mm 200 mm
240 mm 300 mm

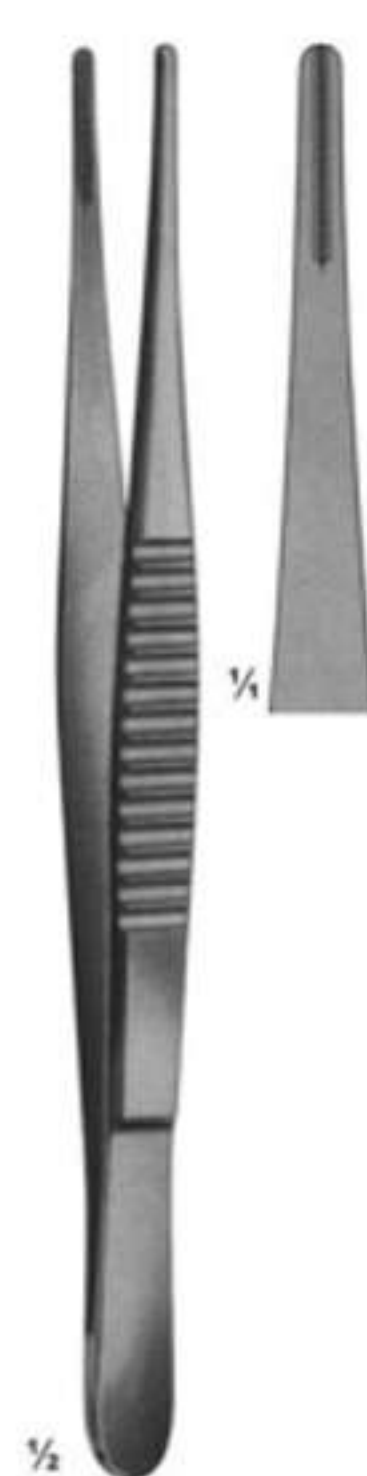

DMI-1-2810
DE BAKLEY 14-117 14-118 14-119
14-120 2,8 mm 2,8 mm 2,8 mm
2,8 mm 150 mm 200 mm
240 mm 300 mm



DMI-1-2811
DE BAKLEY 14-121 14-122 3,3mm
3,5 mm 200 mm 300 mm

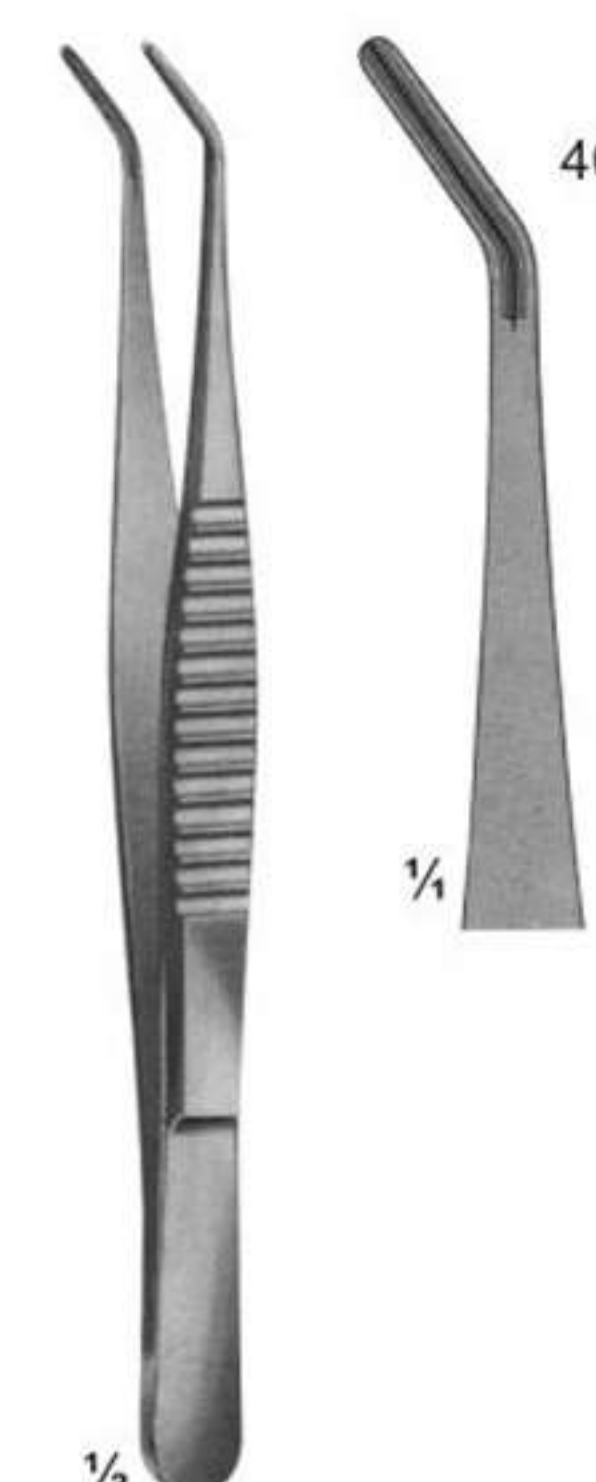

DMI-1-2812
DE BAKLEY 150 mm

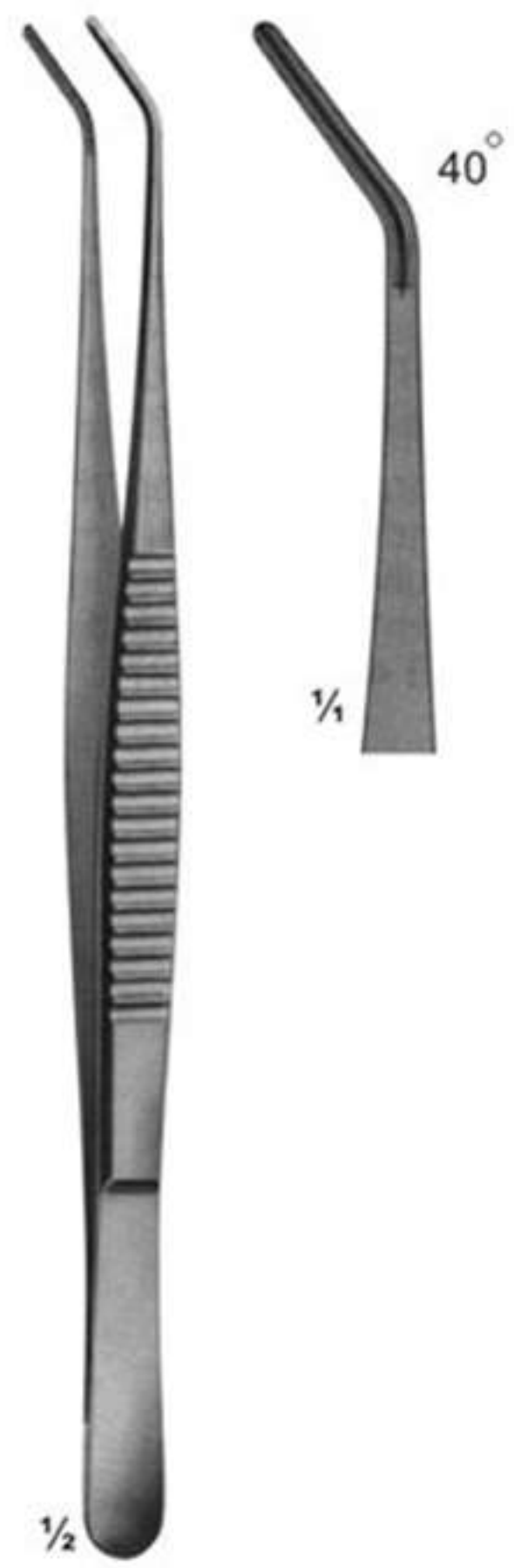

DMI-1-2813
DE BAKEY 200 mm



DMI-1-2814
DE BAKEY 14-126 170 mm 14-127 160 mm



DMI-1-2815
COOLEY 165 mm

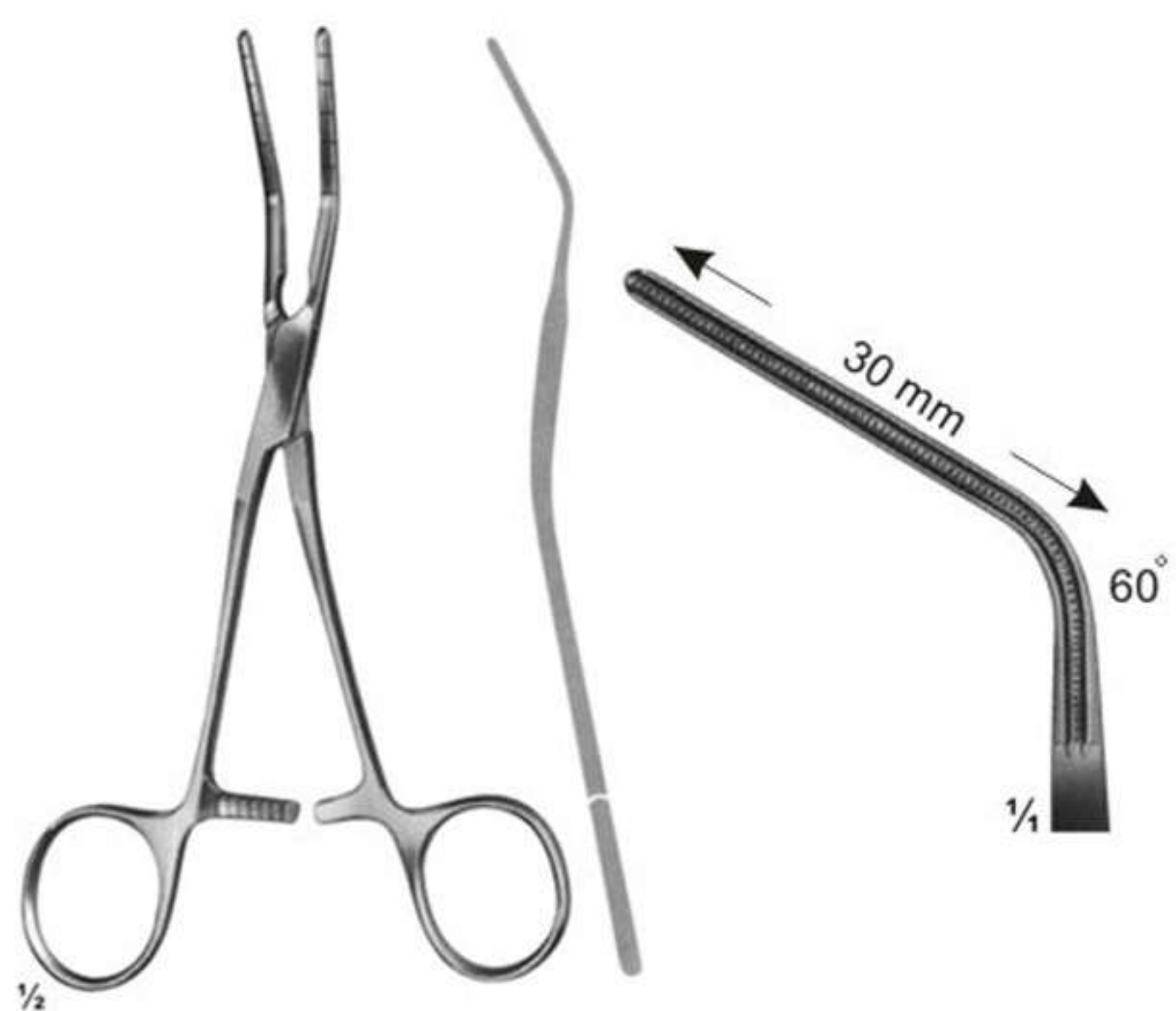
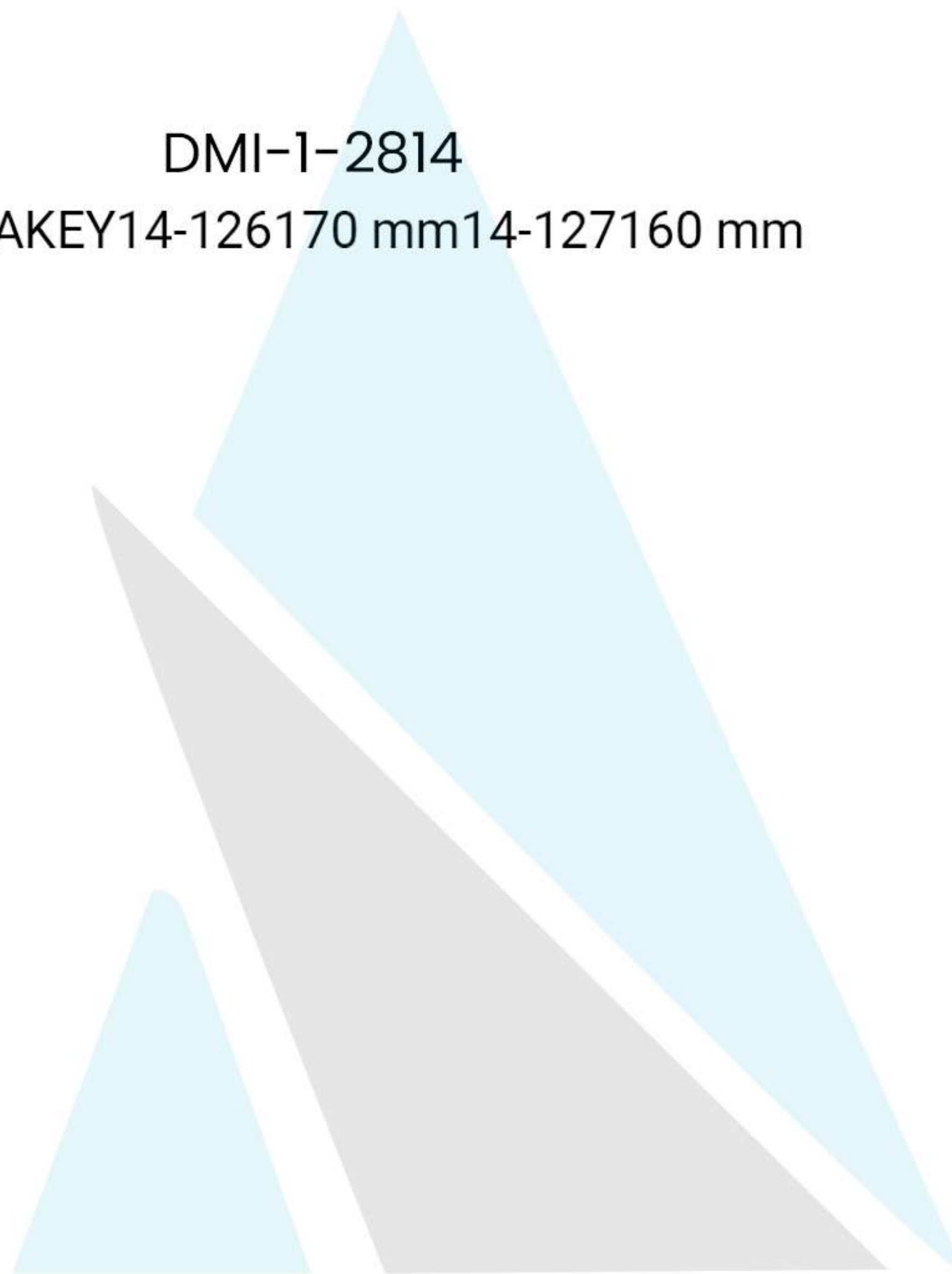

DMI-1-2816
COOLEY 160 mm

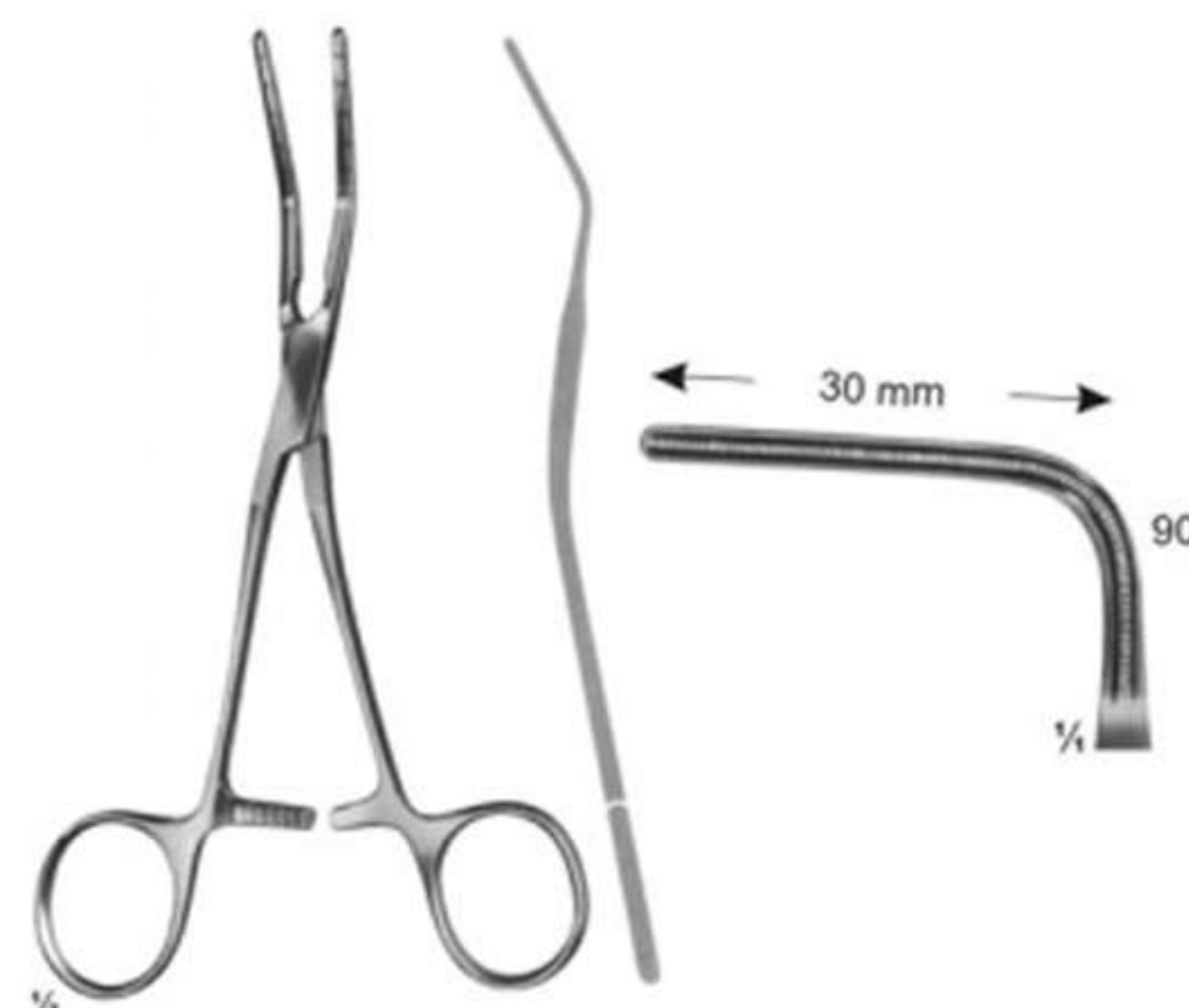

DMI-1-2817
COOLEY 150 mm

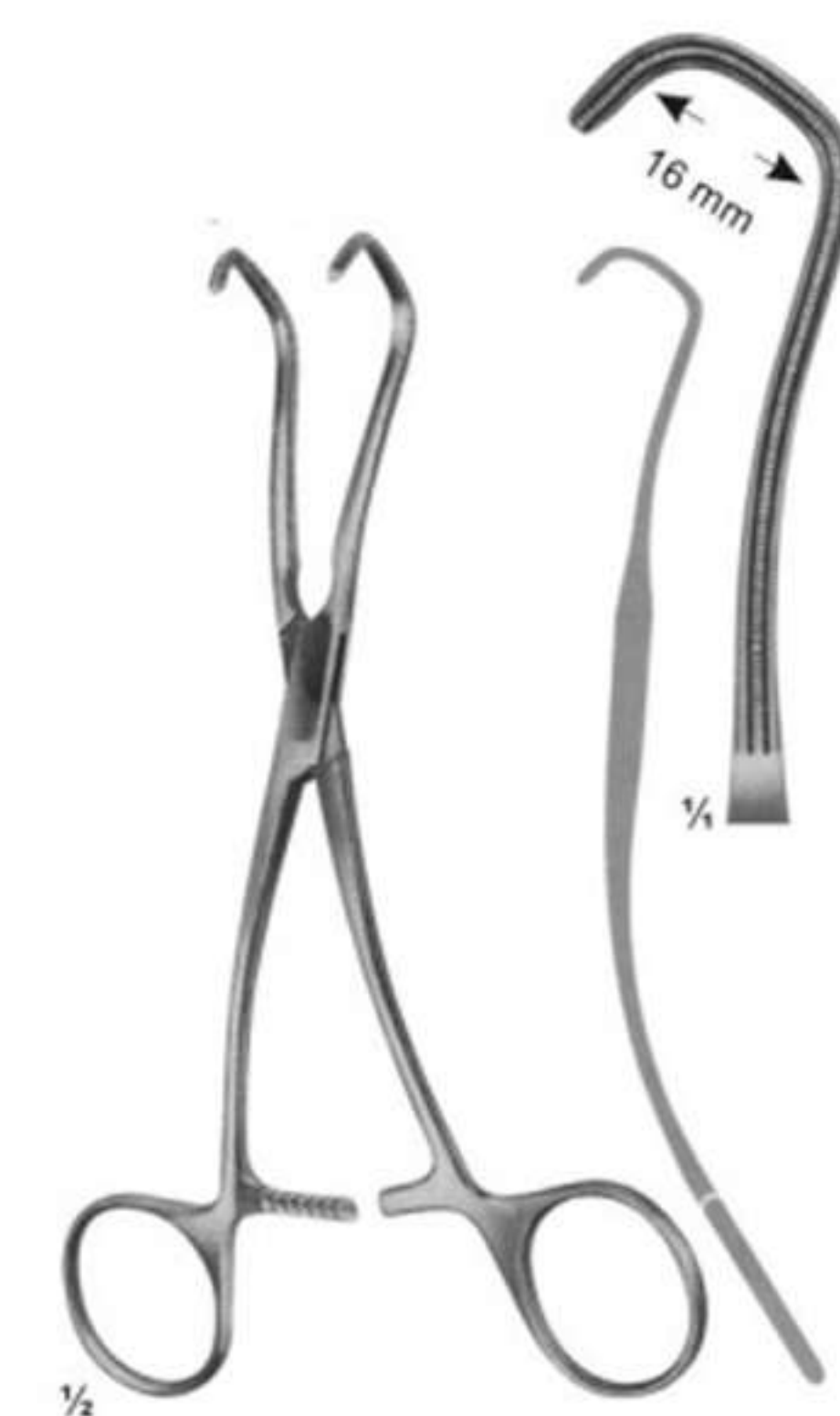

DMI-1-2818
DERRA 170 mm

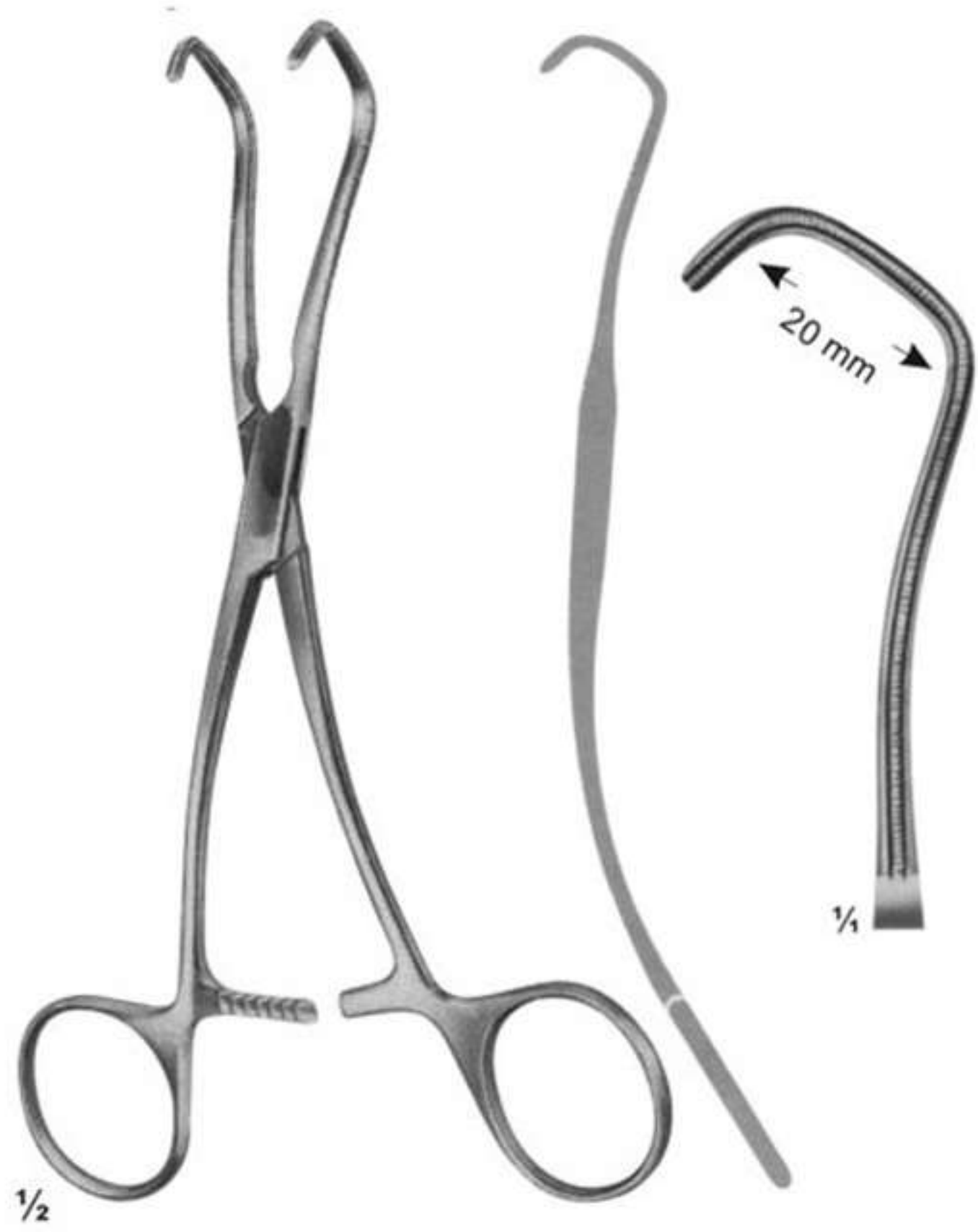

DMI-1-2819
DERRA 170 mm



DMI-1-2820
DERRA 175 mm

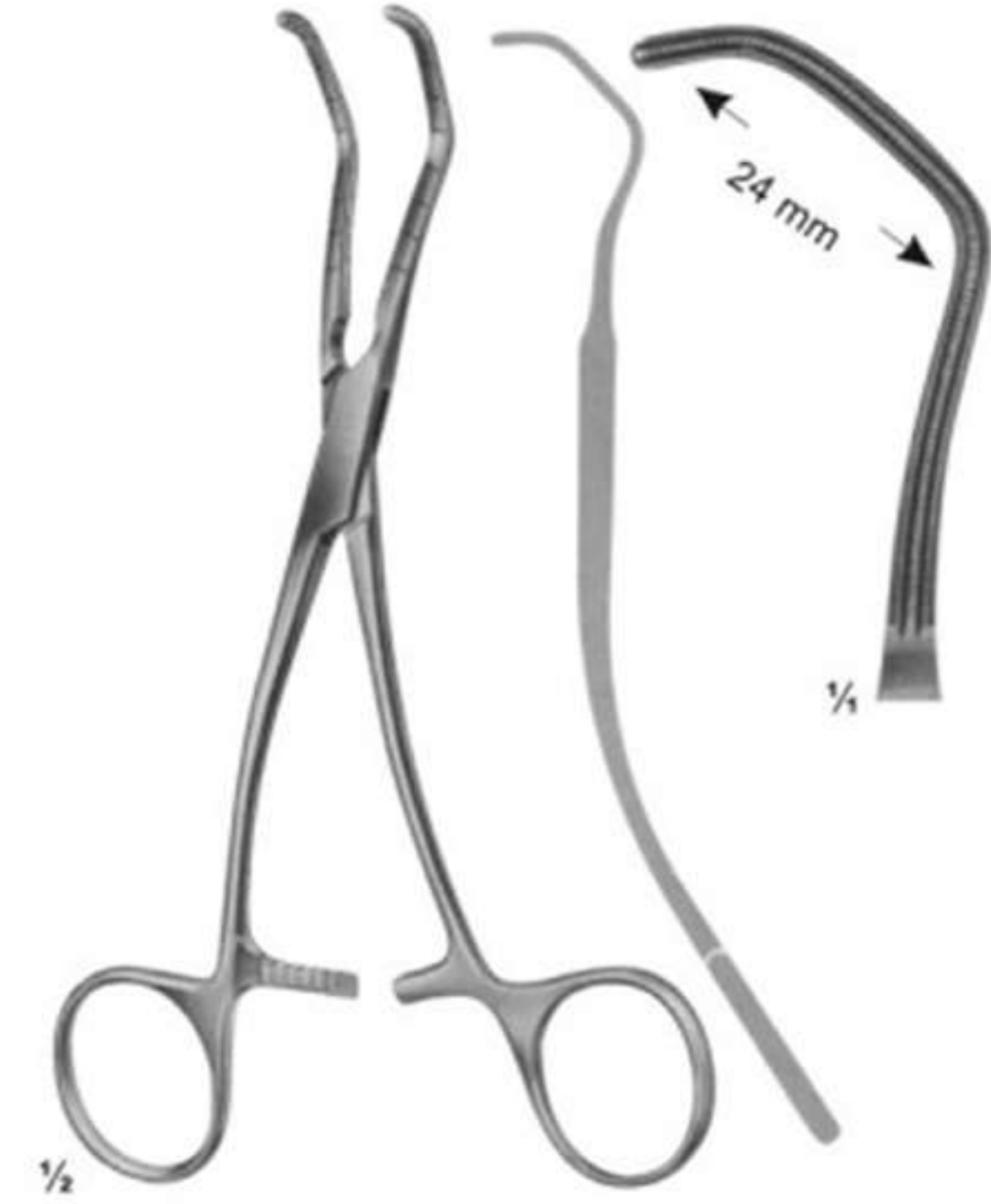

DMI-1-2821
COOLEY14-134COOLEY160 mm

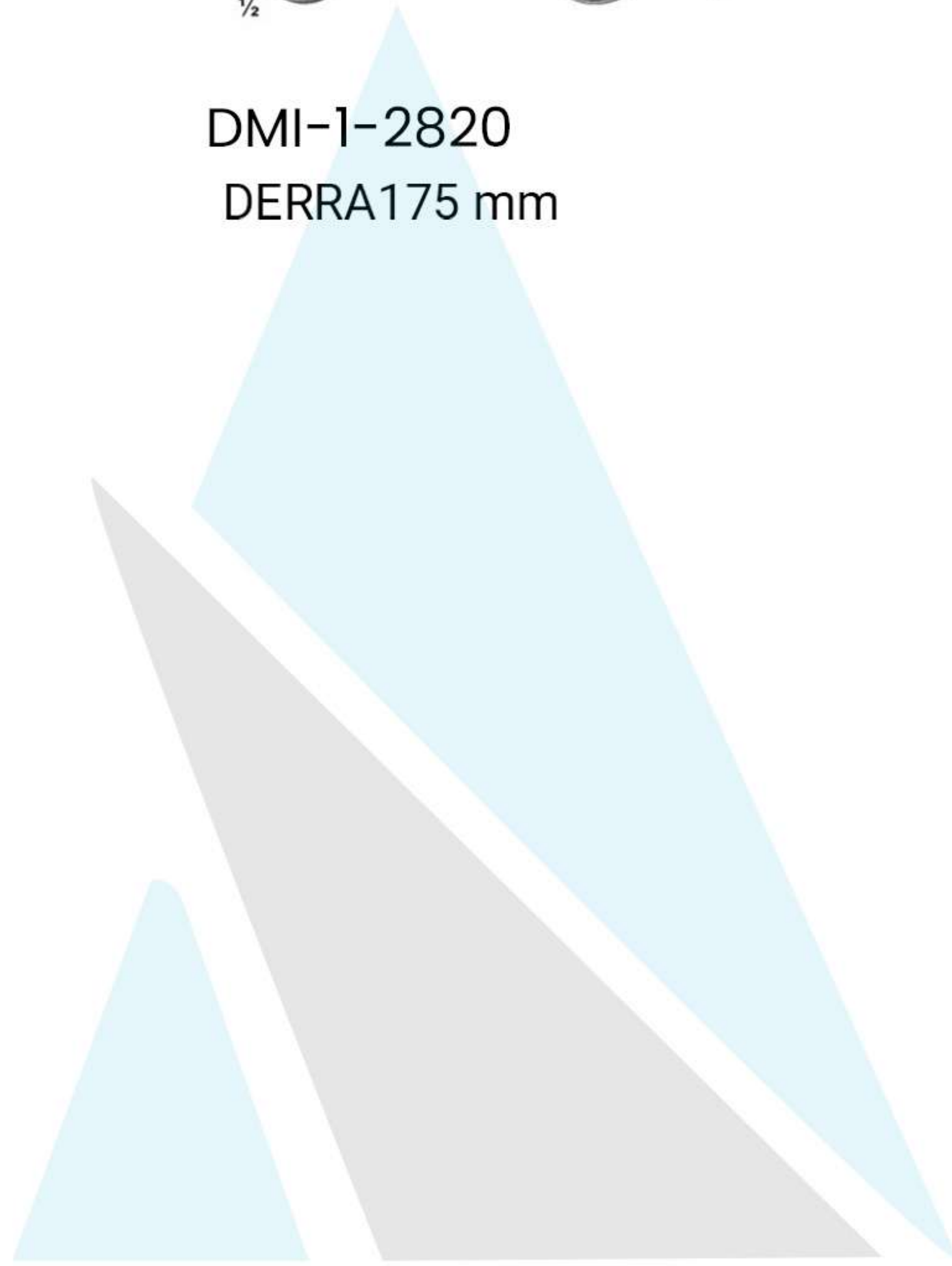

DMI-1-2822
DE BAKEY 41 mm205 mm



DMI-1-2823
DE BAKEY 65 mm22 mm



DMI-1-2824
DE BAKEY 80 mm240 mm



DMI-1-2825
DE BAKAY



DMI-1-2826
DE BAKAY 210 mm



DMI-1-2827
DE BAKAY 210 mm



DMI-1-2828
DE BAKAY 160 mm



DMI-1-2829
WEBER 260 mm



DMI-1-2830
WEBER 260 mm

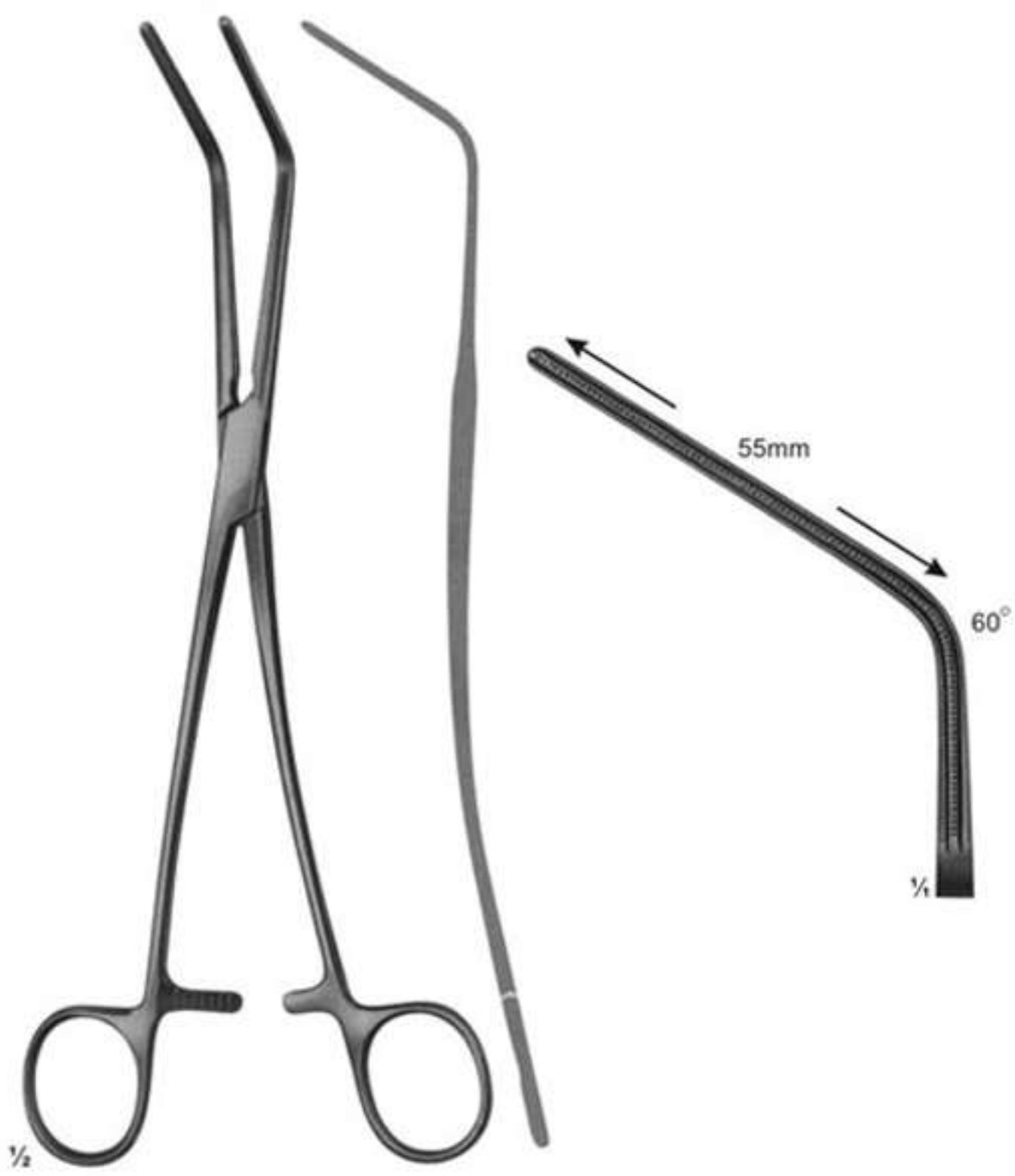

DMI-1-2831
DE BAKEY



DMI-1-2832
DE BAKEY



DMI-1-2833
SCHUMACHER Sternum shears 210 mm



DMI-1-2834
LEBSCHE Sternum chisel 200 mm



DMI-1-2835
230 mm



DMI-1-2836
COLLIN 195 mm



DMI-1-2837
GLUCK 190 mm



DMI-1-2838
BETHUNE 340 mm



DMI-1-2839
BRUNNER Universal pattern 340 mm

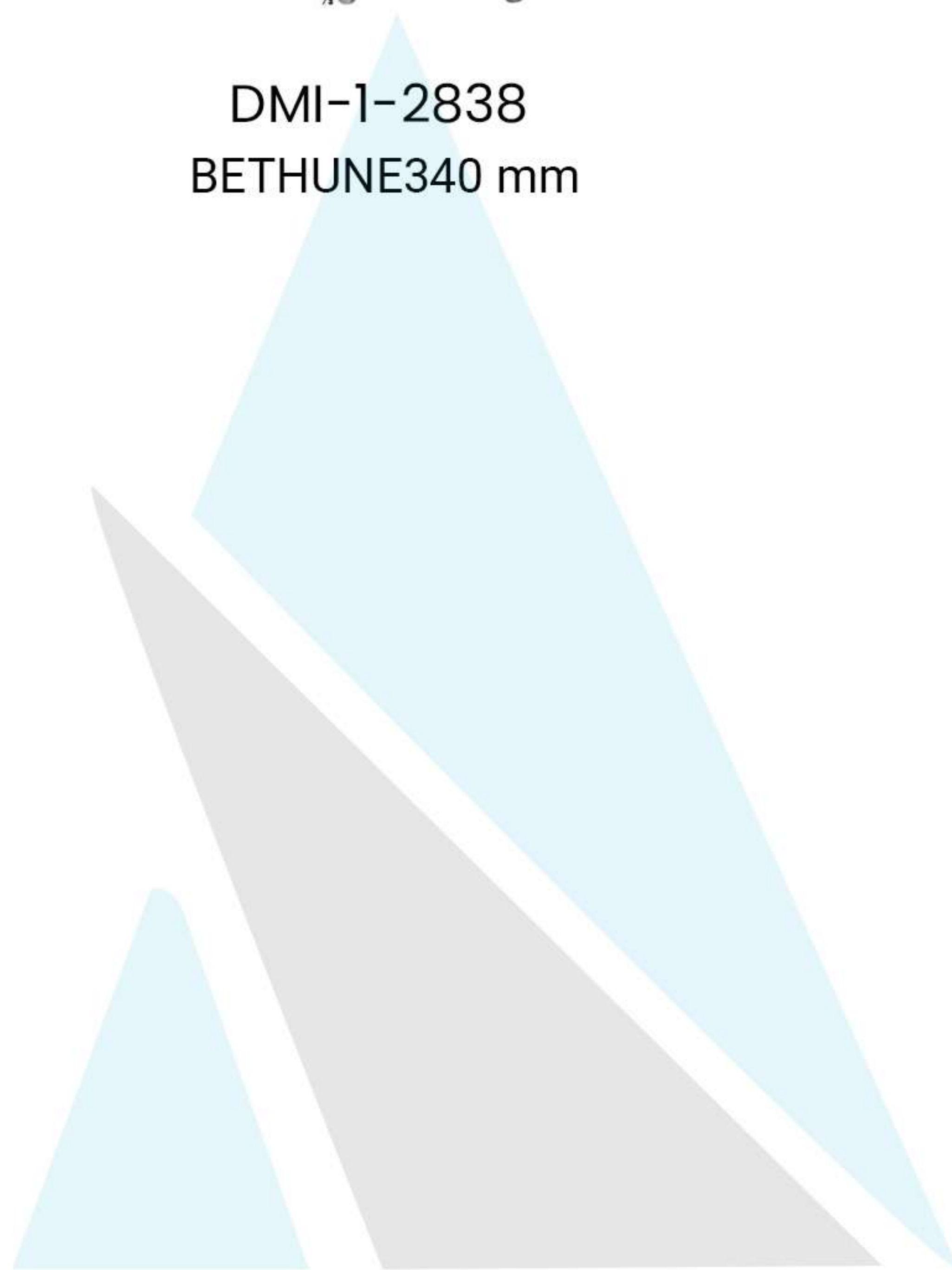

DMI-1-2840
GIERTZ-STILLE 250 mm

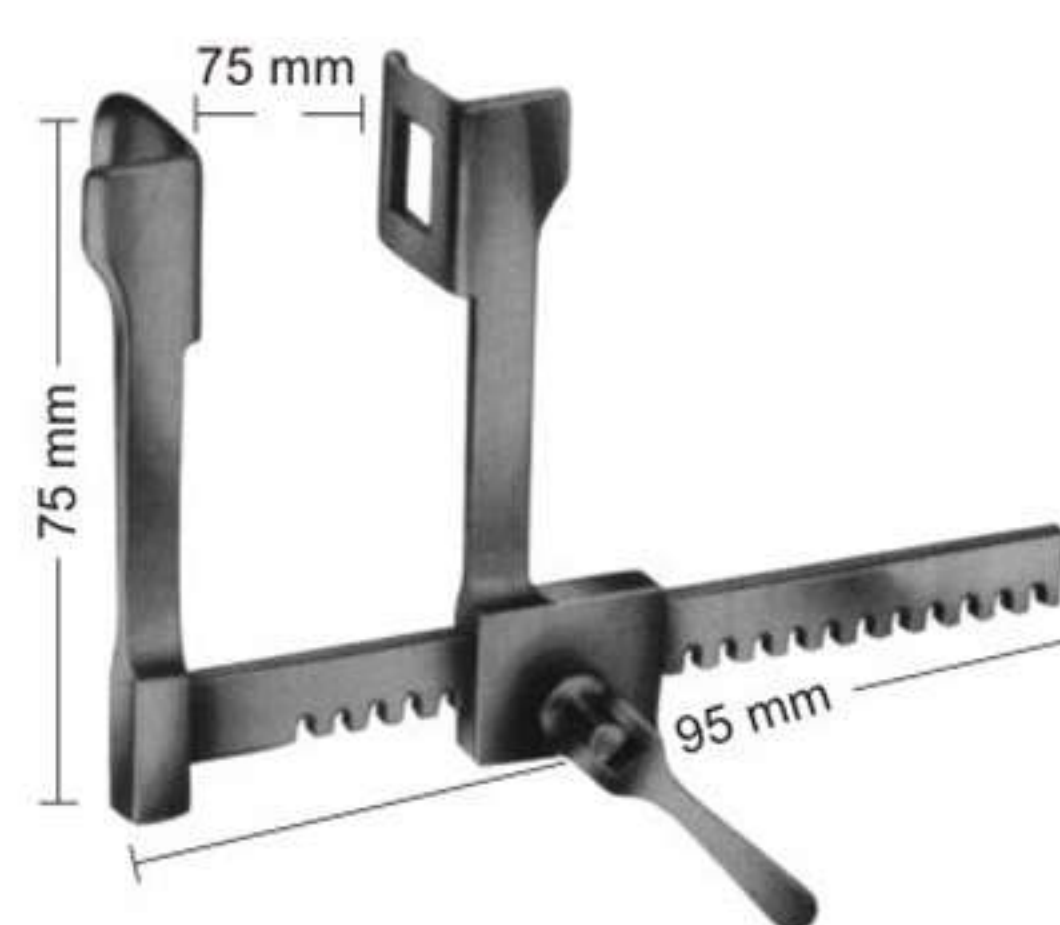

DMI-1-2841
FINOCHIETTO Blades 18X21 mm



DMI-1-2842
HERTZLER Blades 20X25 mm

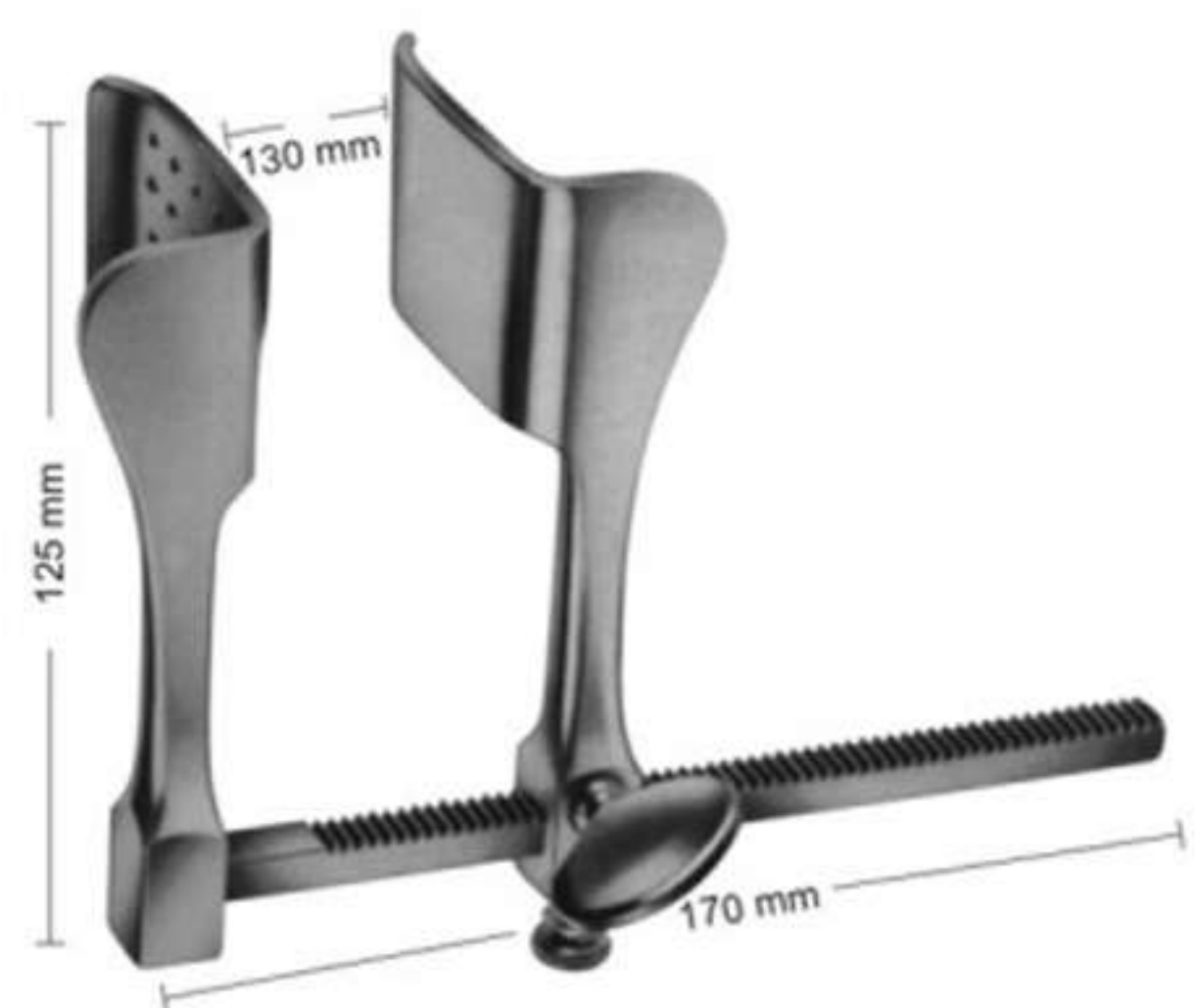

DMI-1-2843
TUFFIERBlades43X53 mm

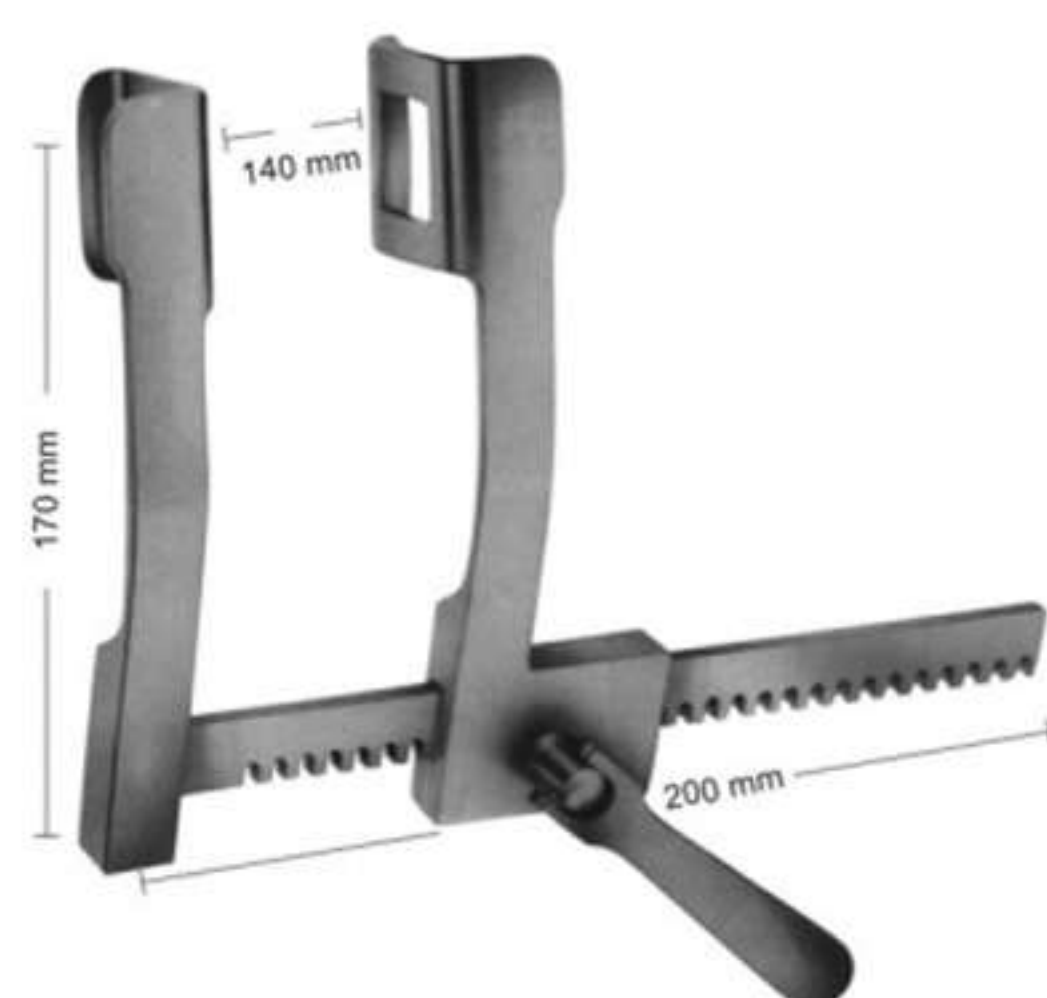

DMI-1-2844
FINOCHIETTOBlades36X45 mm



DMI-1-2845
BRUNNER Universal pattern 340 mm



DMI-1-2846
BAILEY150 mm



DMI-1-2847
BAILEY200 mm



DMI-1-2848
BAILEY200 mm

Bone Punches, Rongeurs

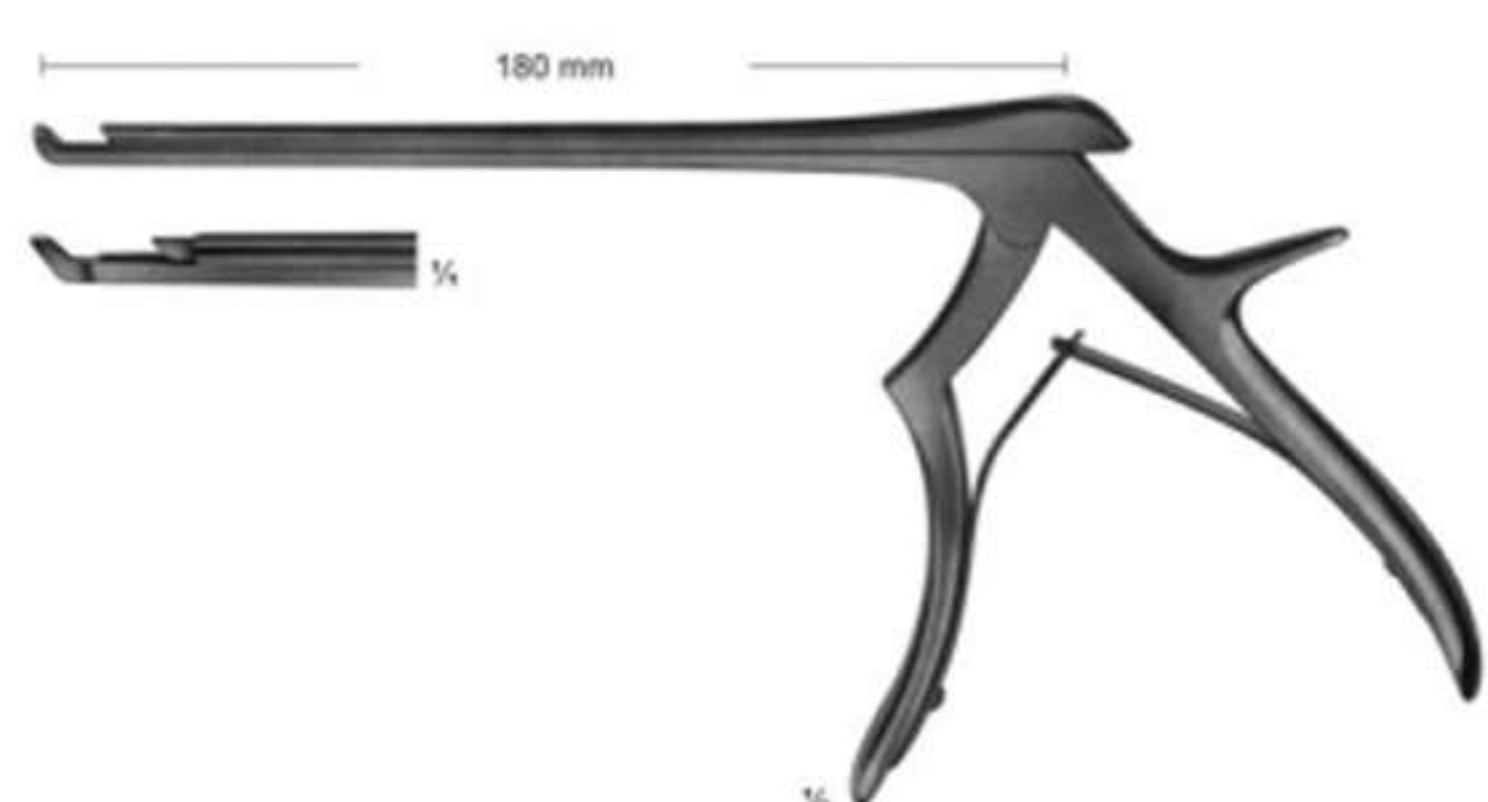

DMI-1-2901
KERRISON - JACOBY 15 mm

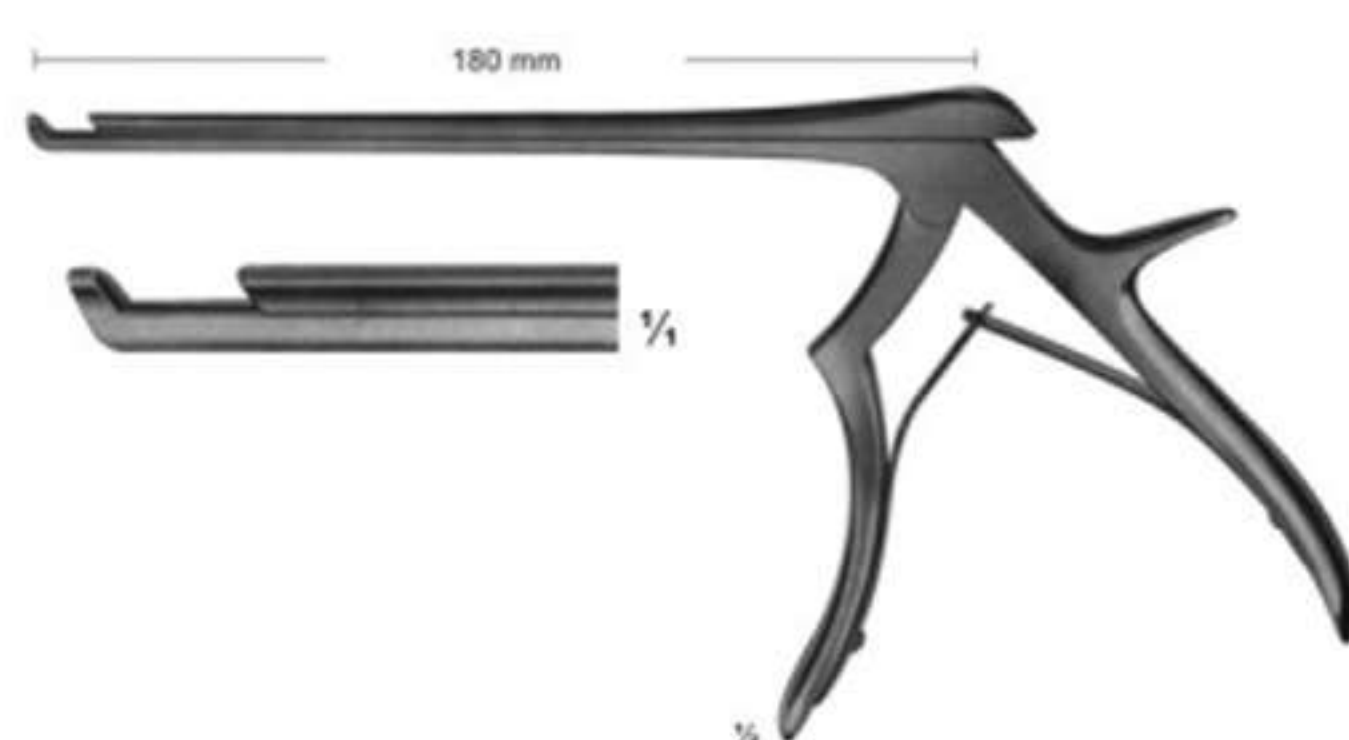

DMI-1-2902
FERRIS-SMITH-KERRISON

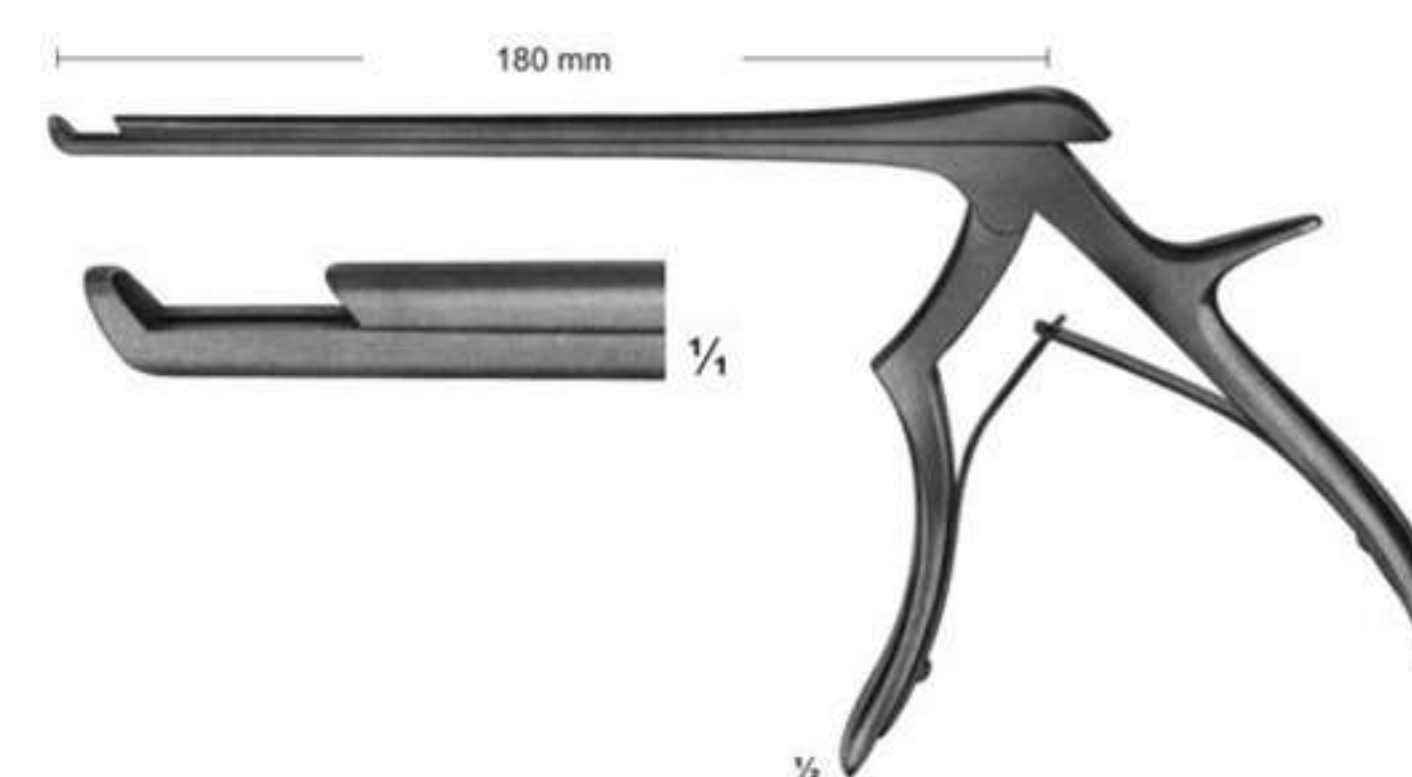

DMI-1-2903
3 mm

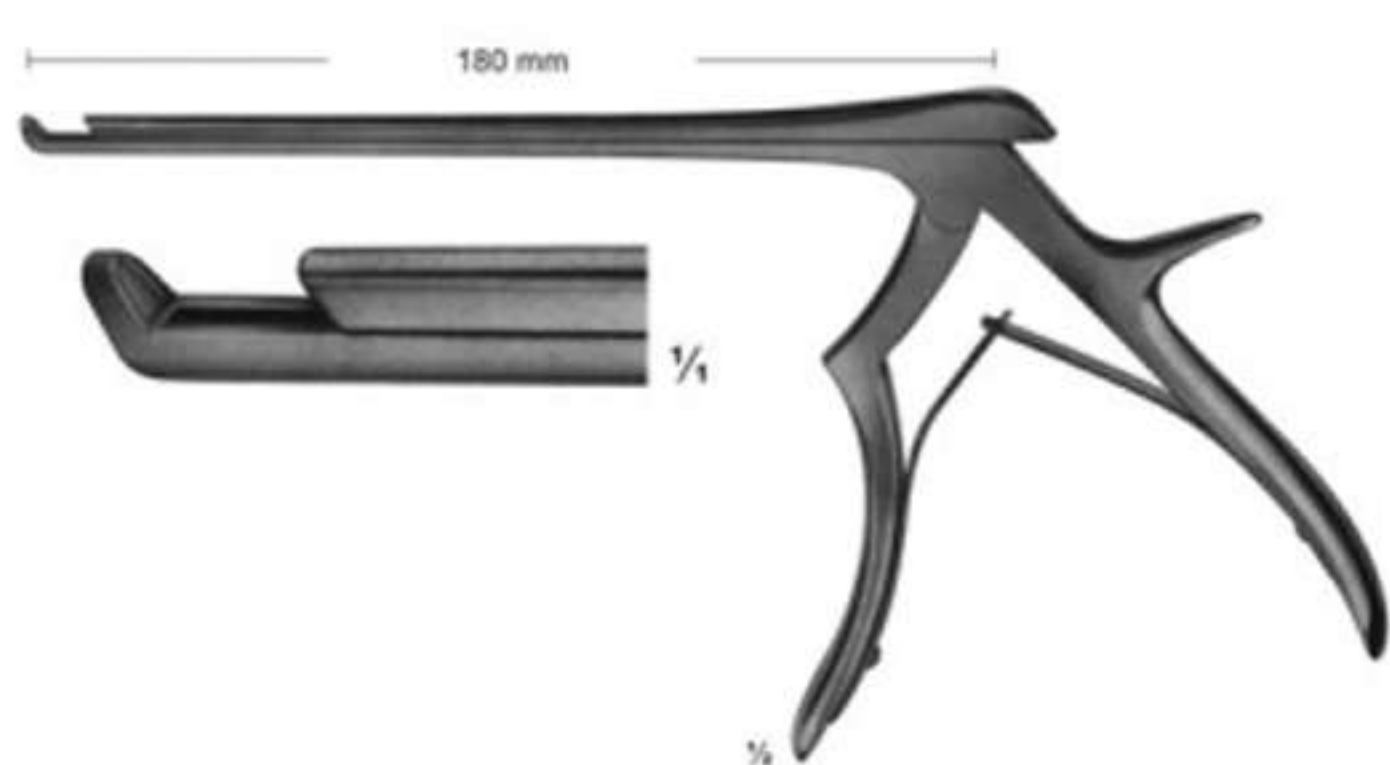

DMI-1-2904
4 mm

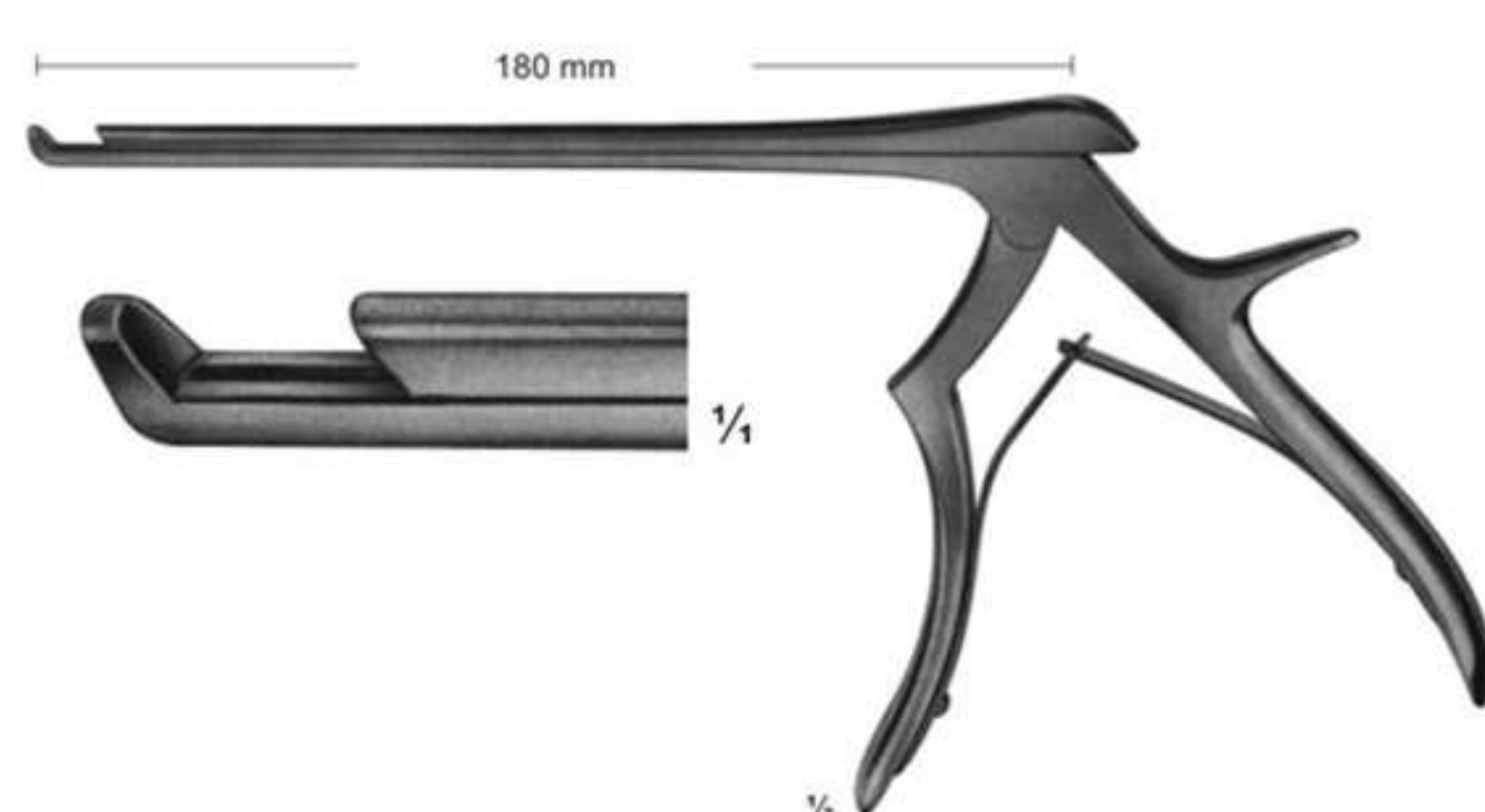

DMI-1-2905
5 mm

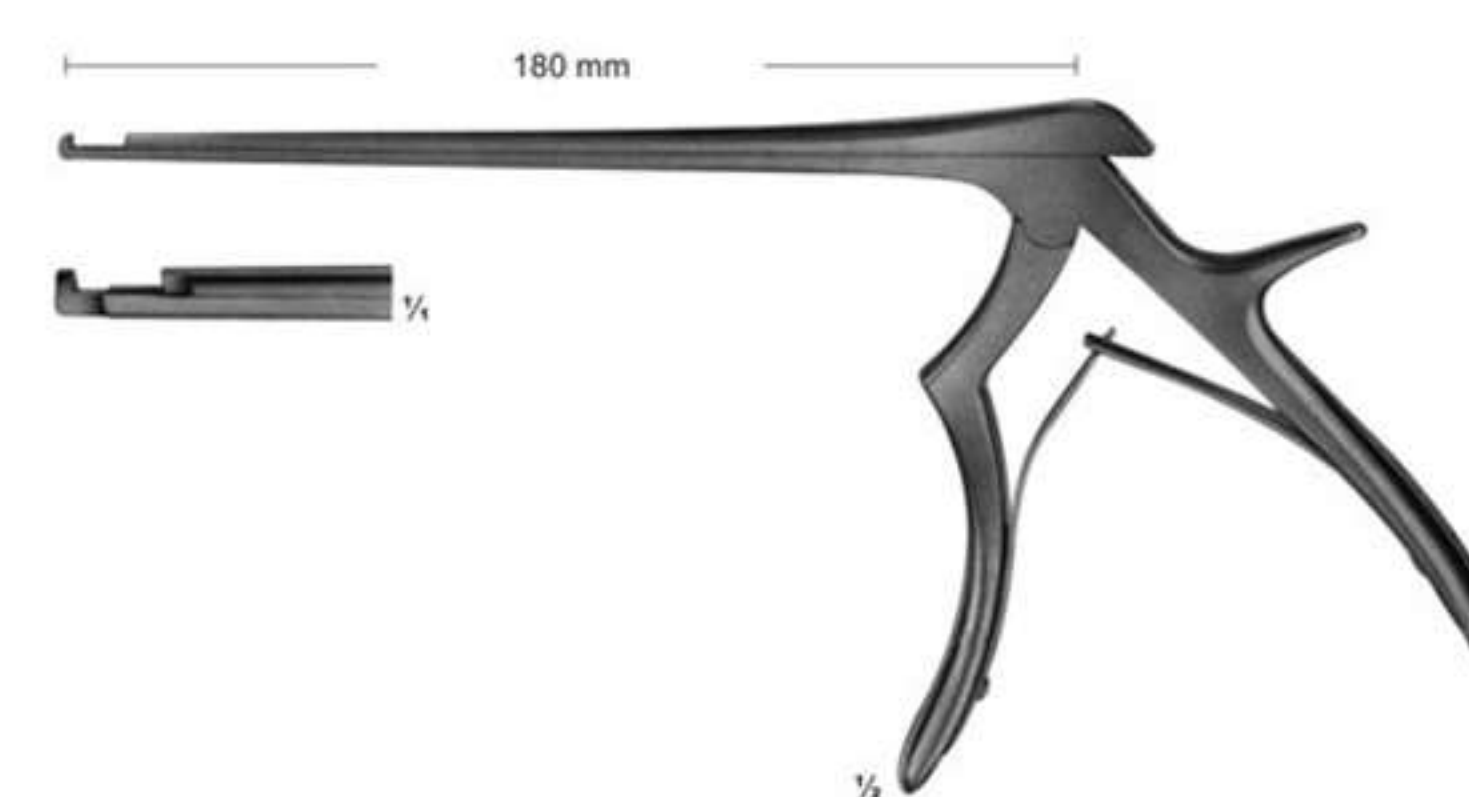

DMI-1-2906
KERRISON - JACOBY 1 mm

Bone Punches, Rongeurs

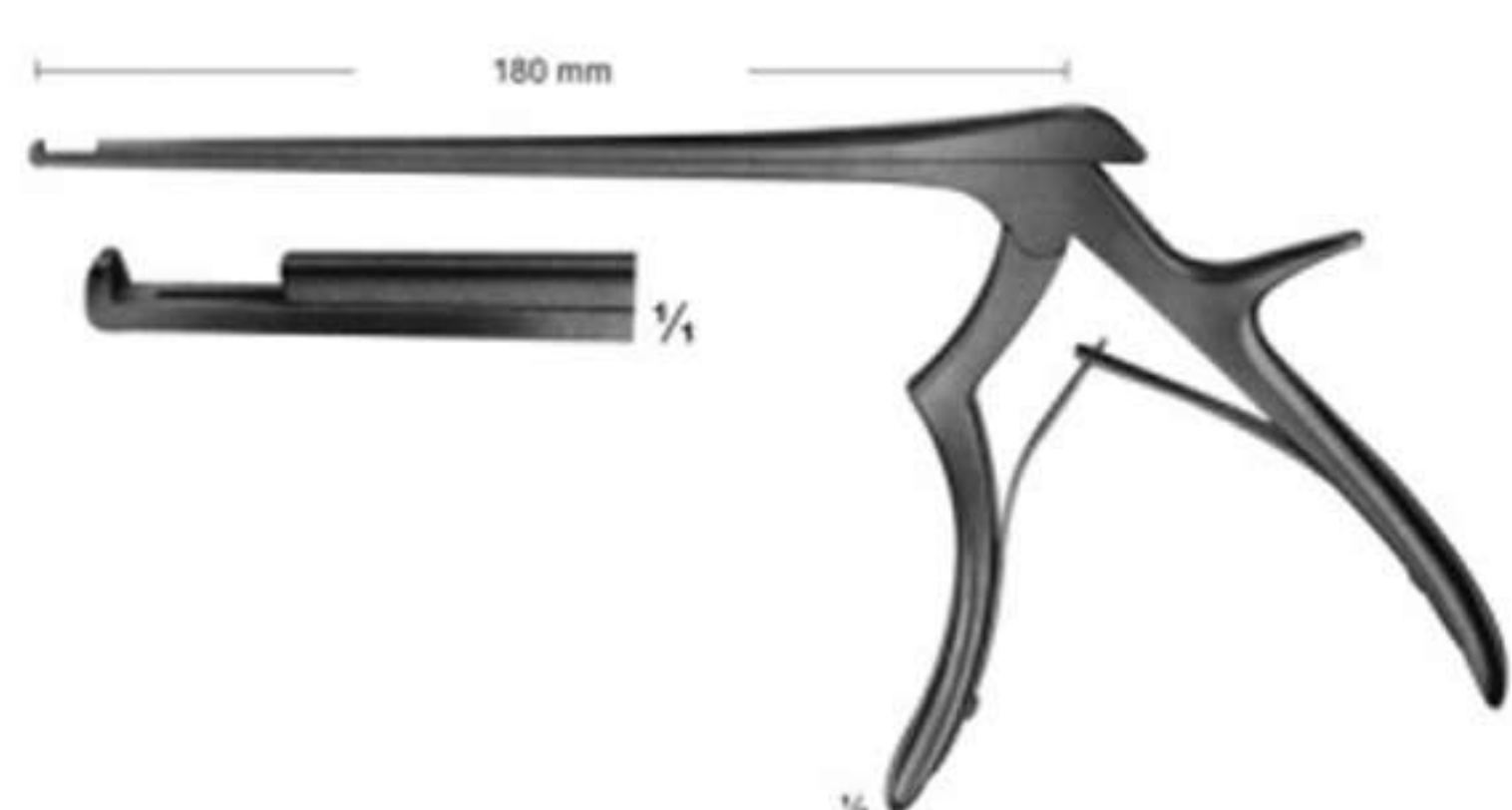

DMI-1-2907
2 mm

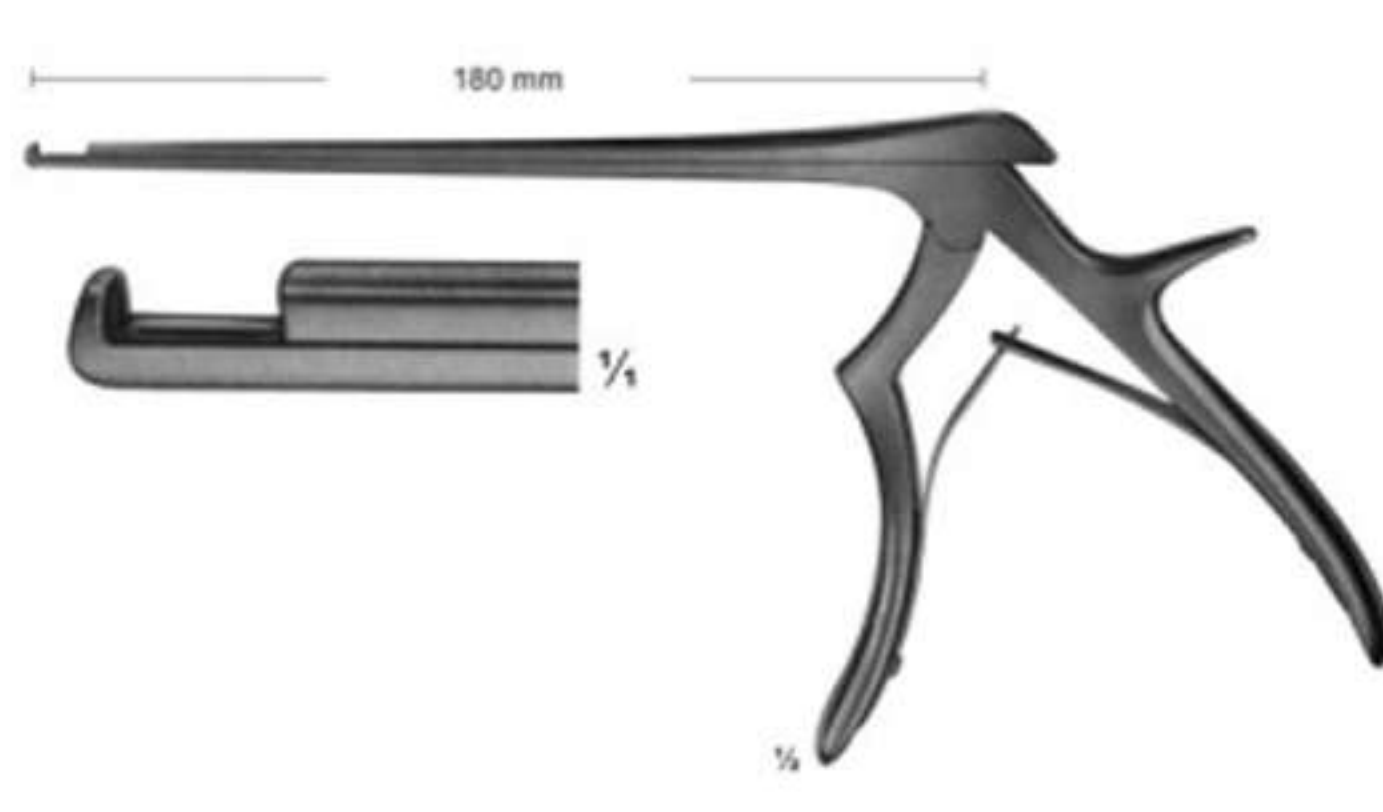

DMI-1-2908
FERRIS-SMITH-KERRISON 3 mm

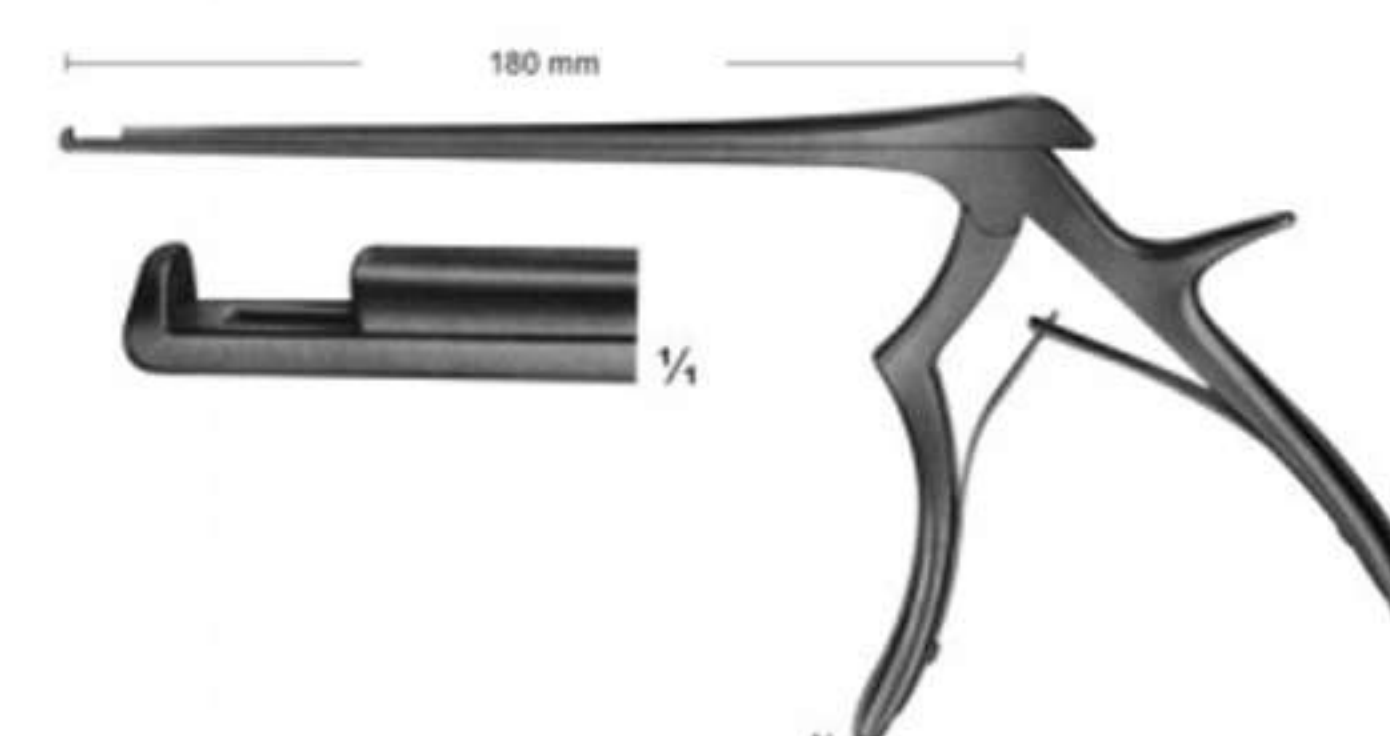

DMI-1-2909
4 mm

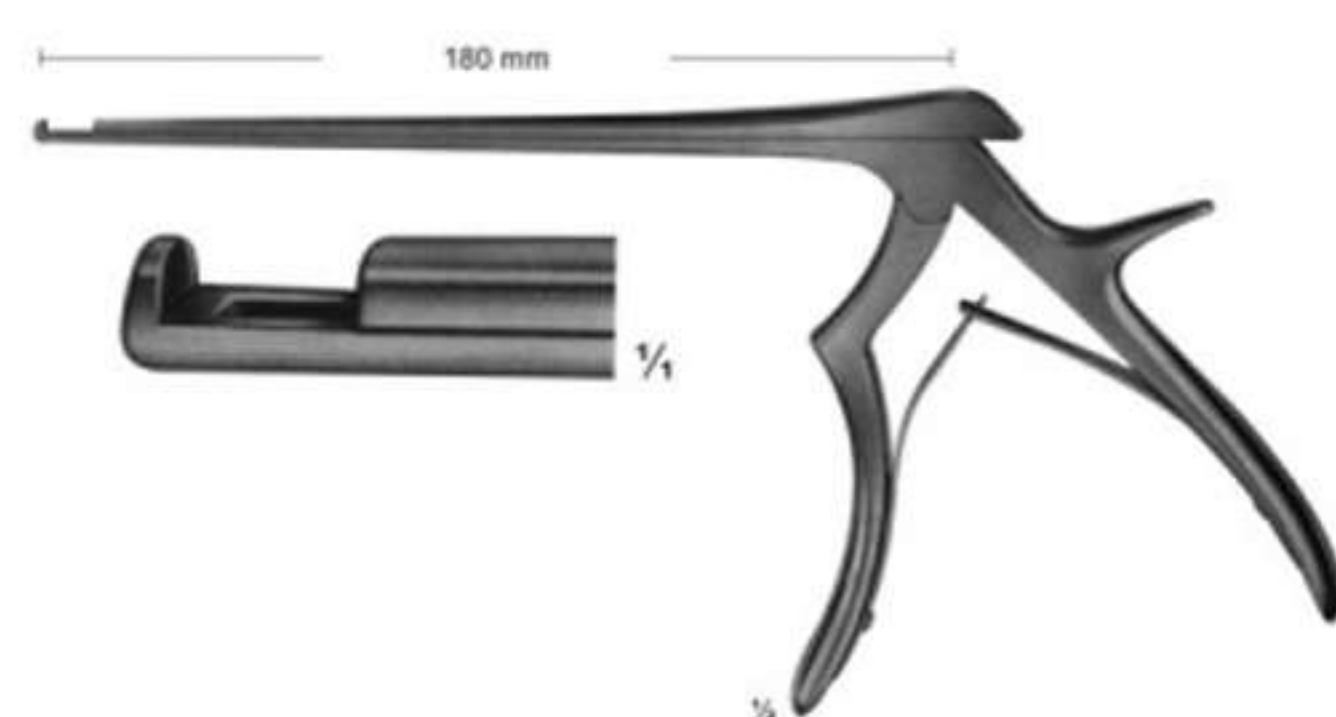

DMI-1-2910
5 mm

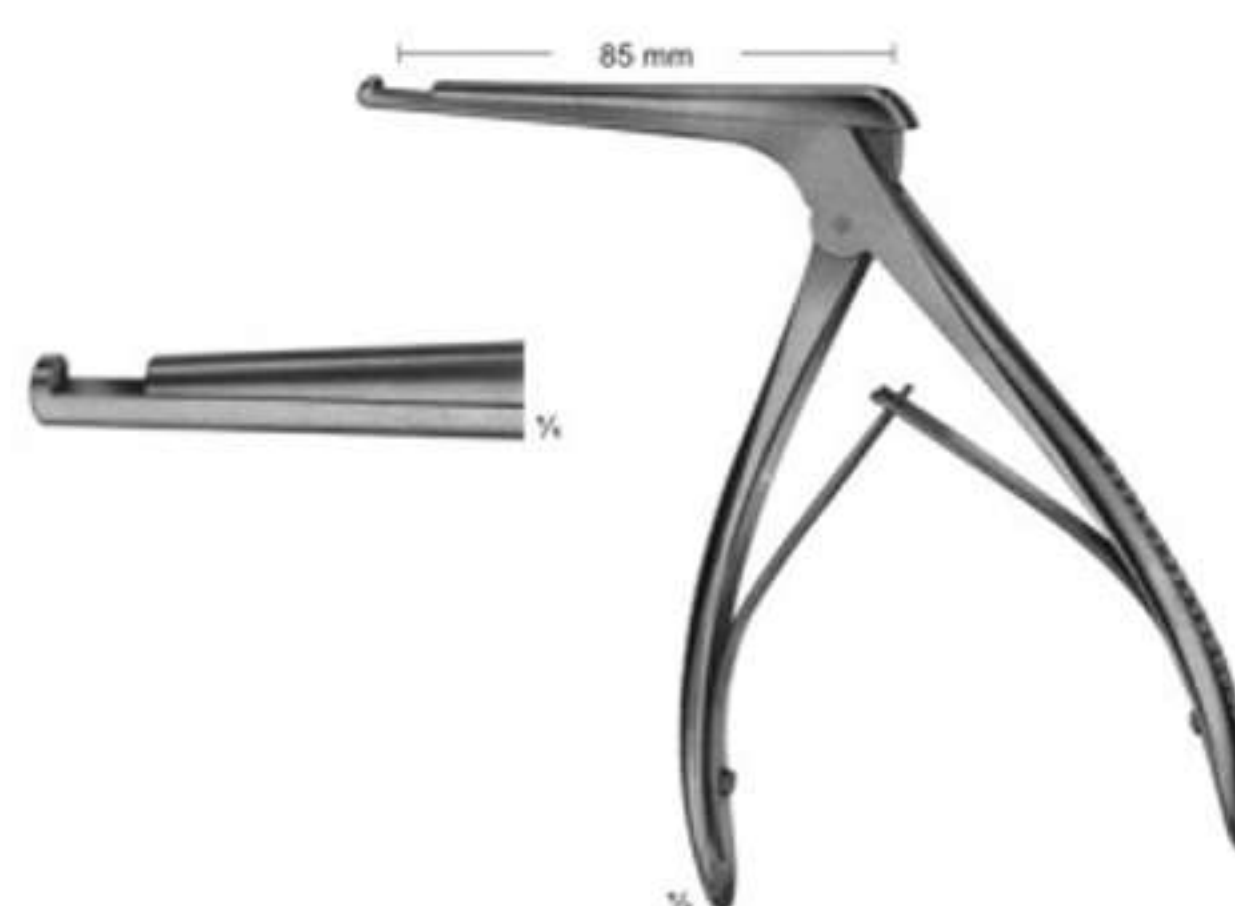

DMI-1-2911
4 mm

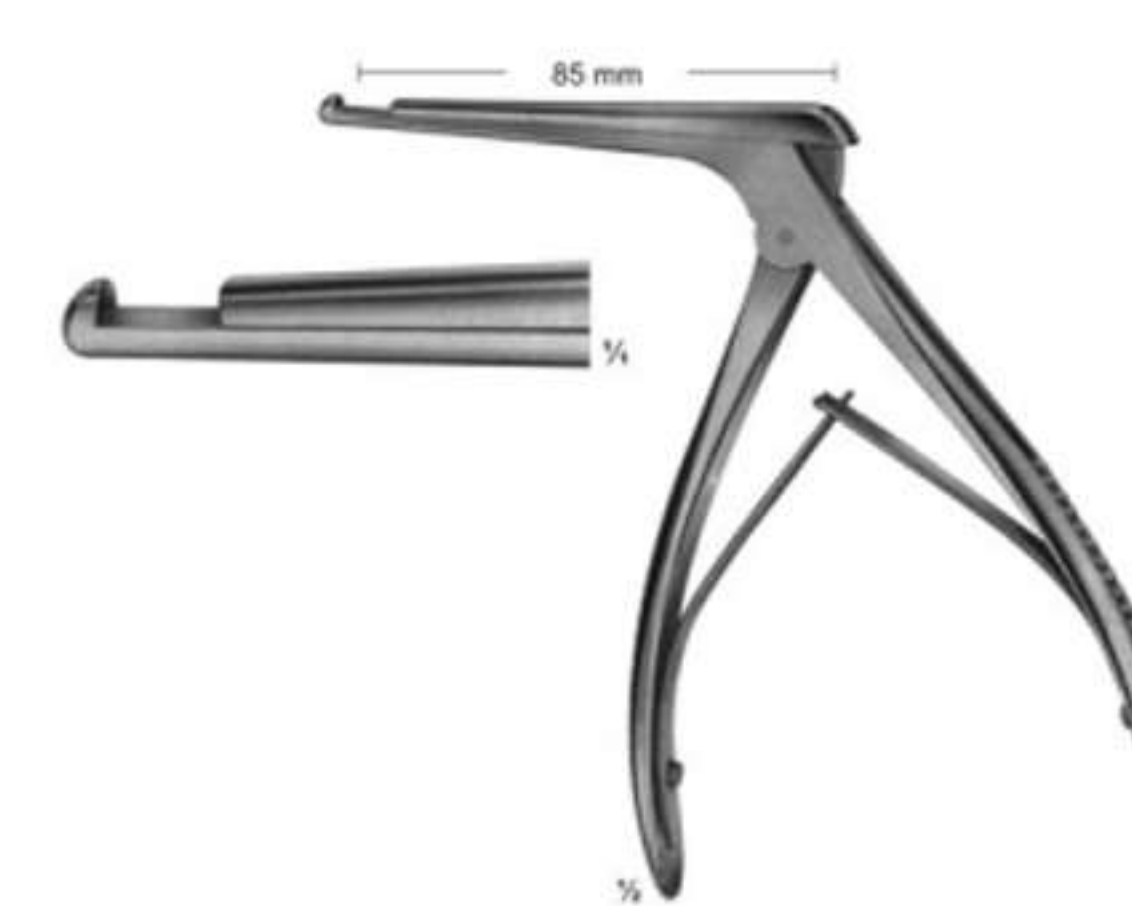

DMI-1-2912
5 mm

Bone Punches, Rongeurs

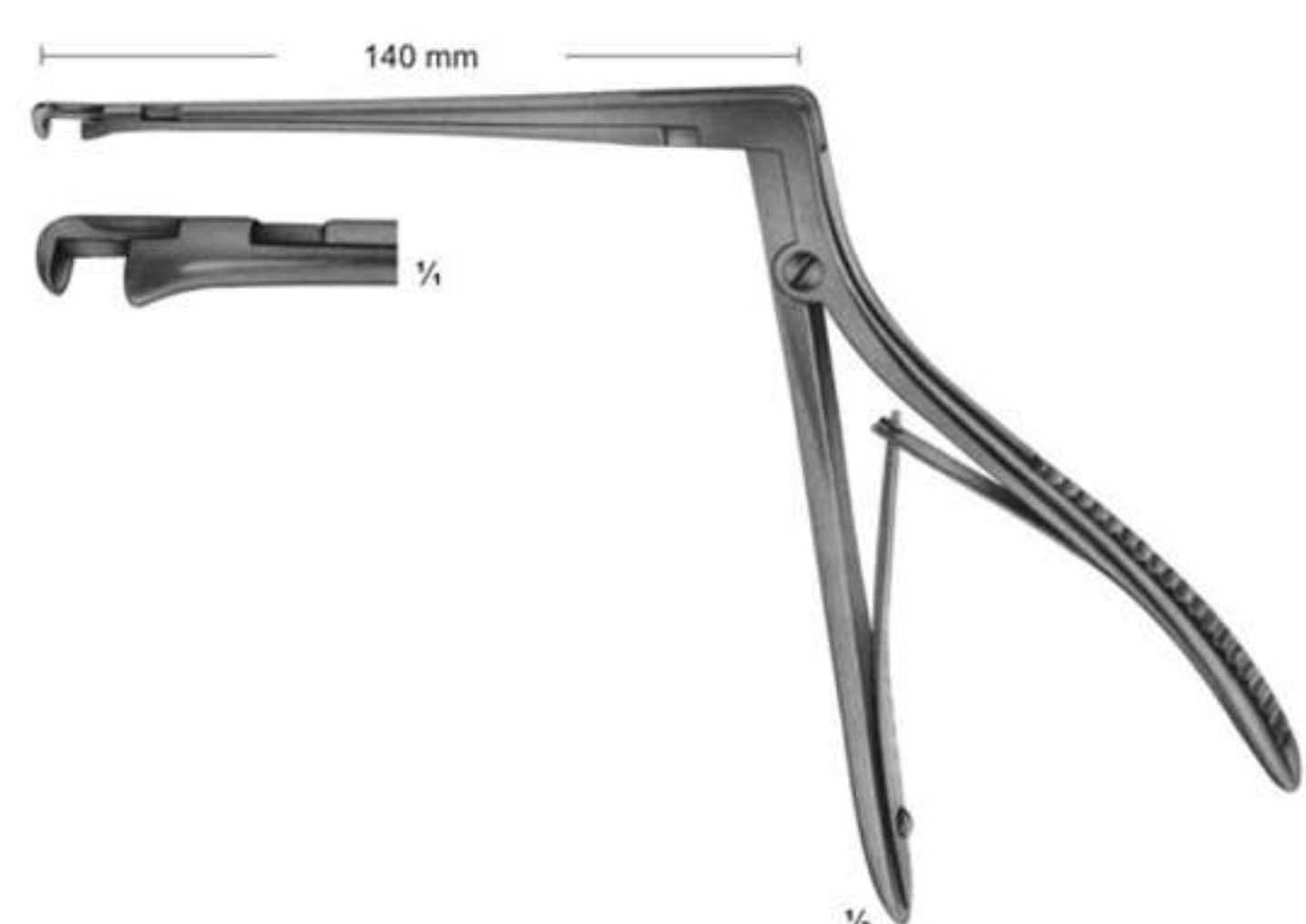

DMI-1-2913
3,3 mm

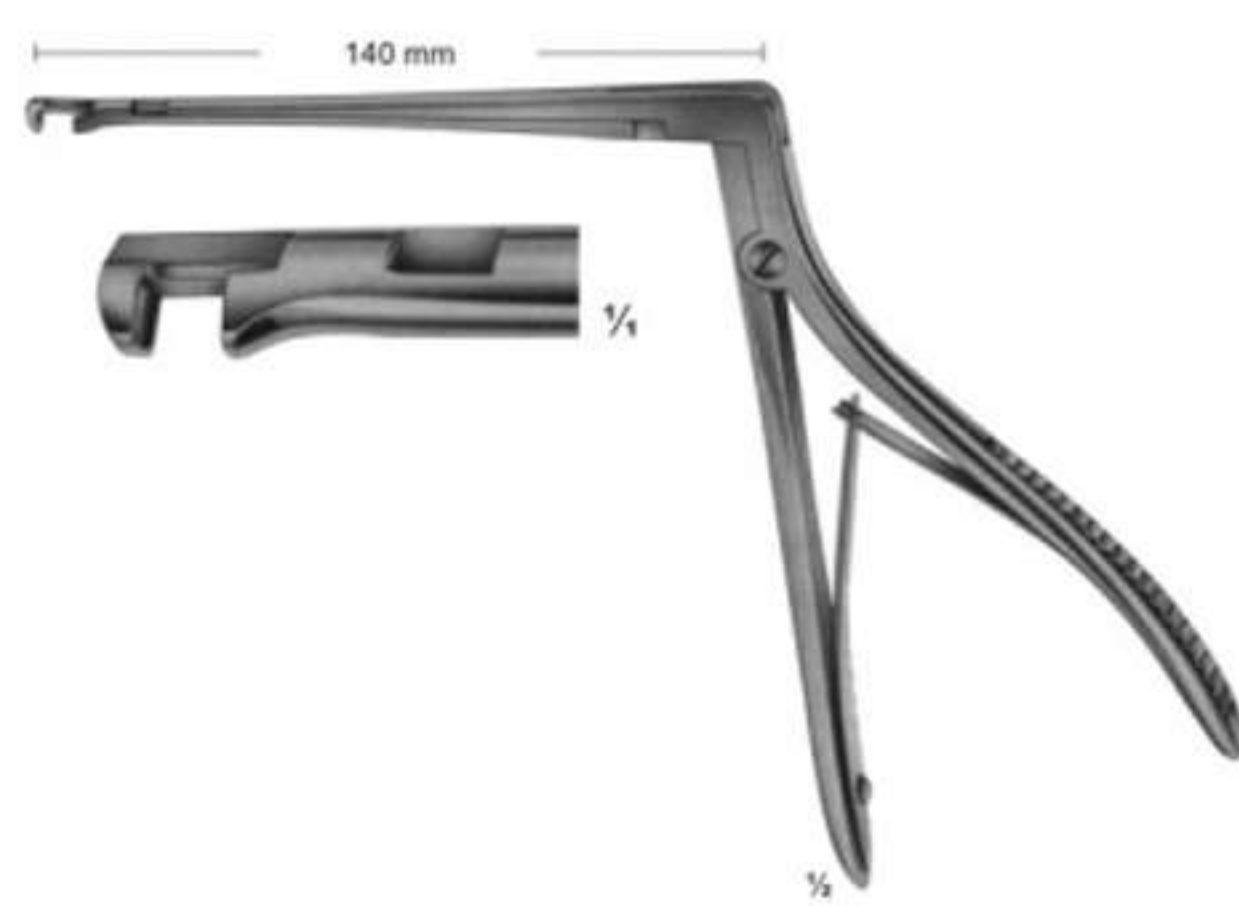

DMI-1-2914
4,0 mm



DMI-1-2915
LOVE-GRUENWALD 2 x 10 mm

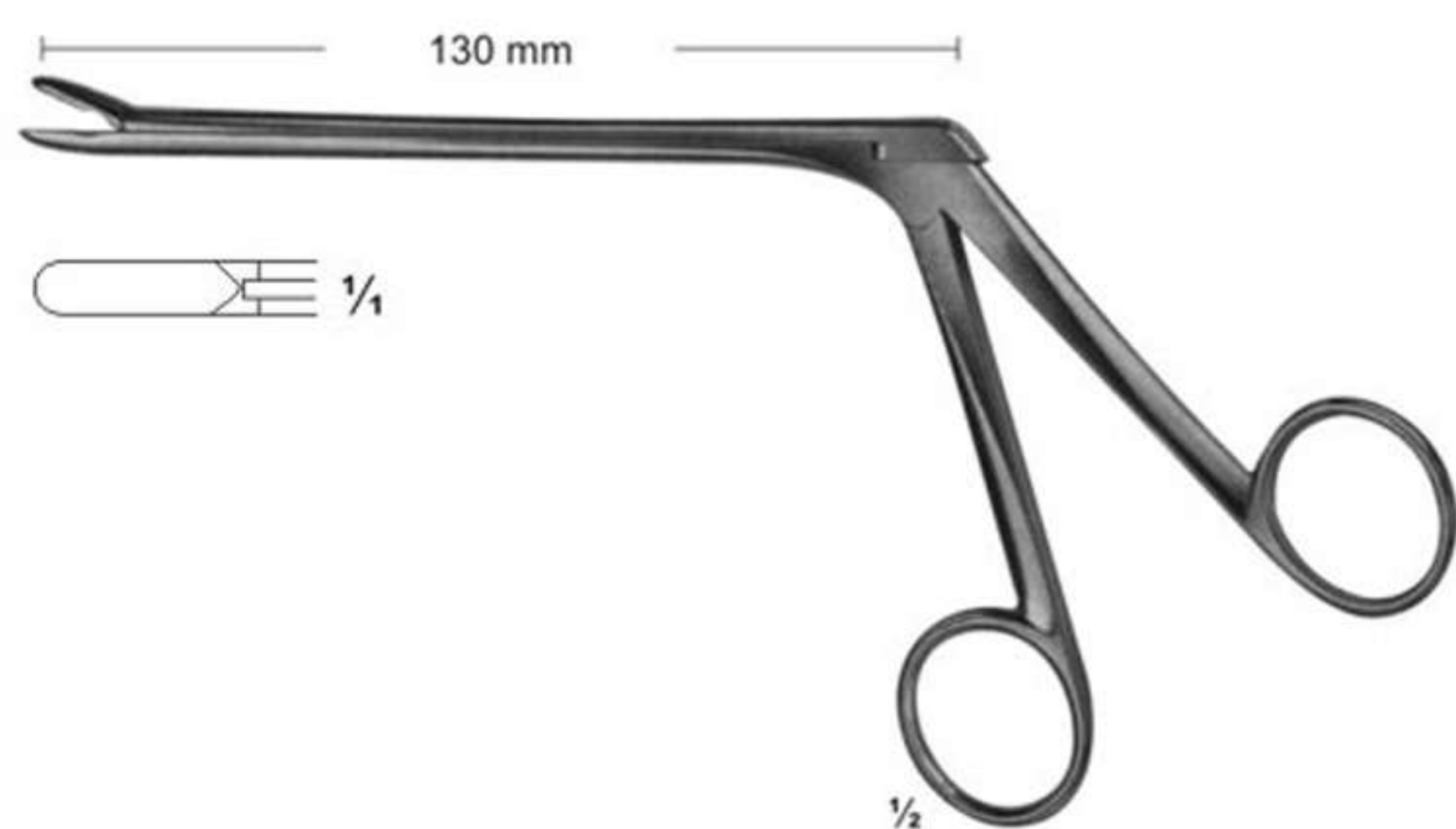

DMI-1-2916
LOVE-GRUENWALD 3 x 10 mm

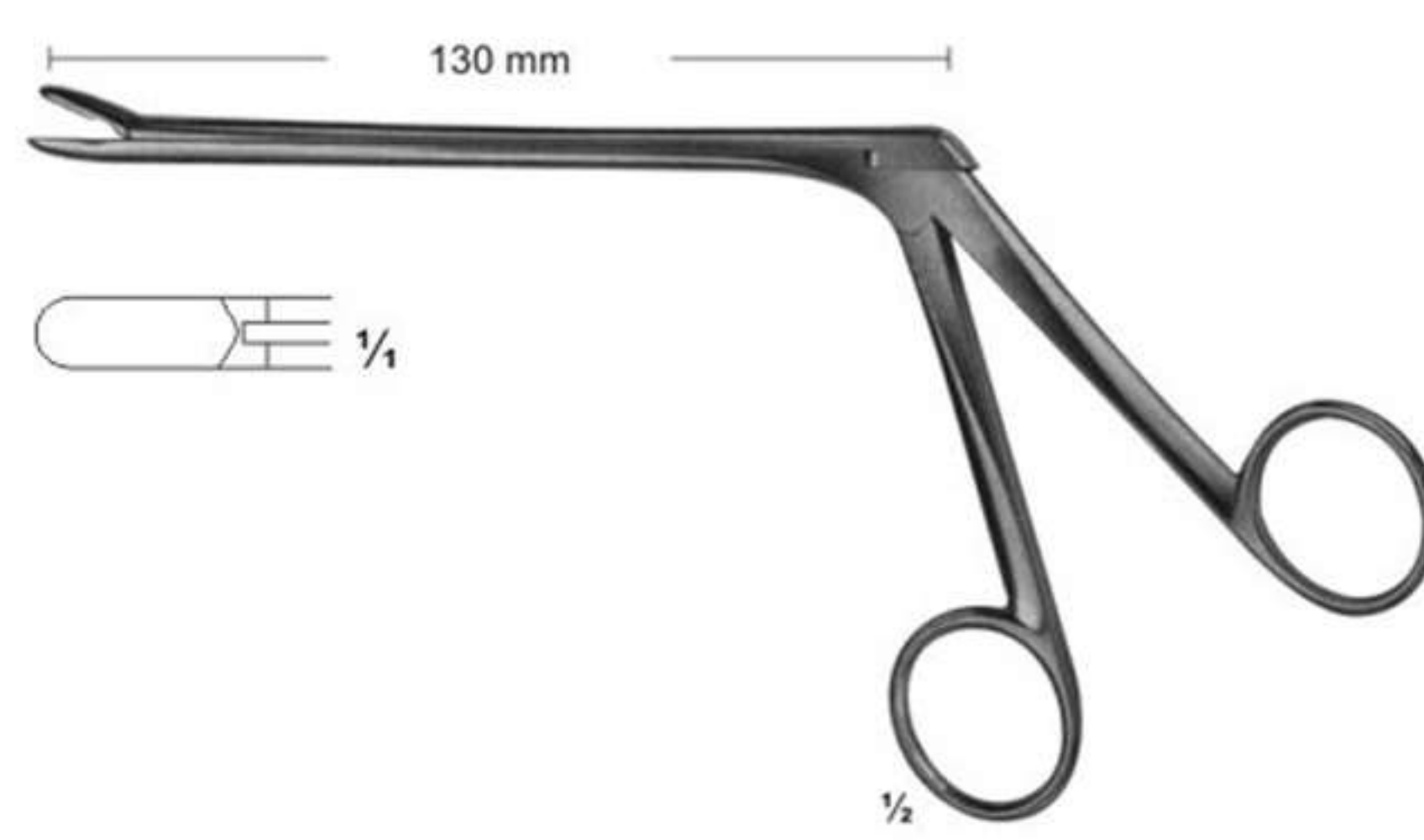

DMI-1-2917
LOVE-GRUENWALD 4 x 10 mm

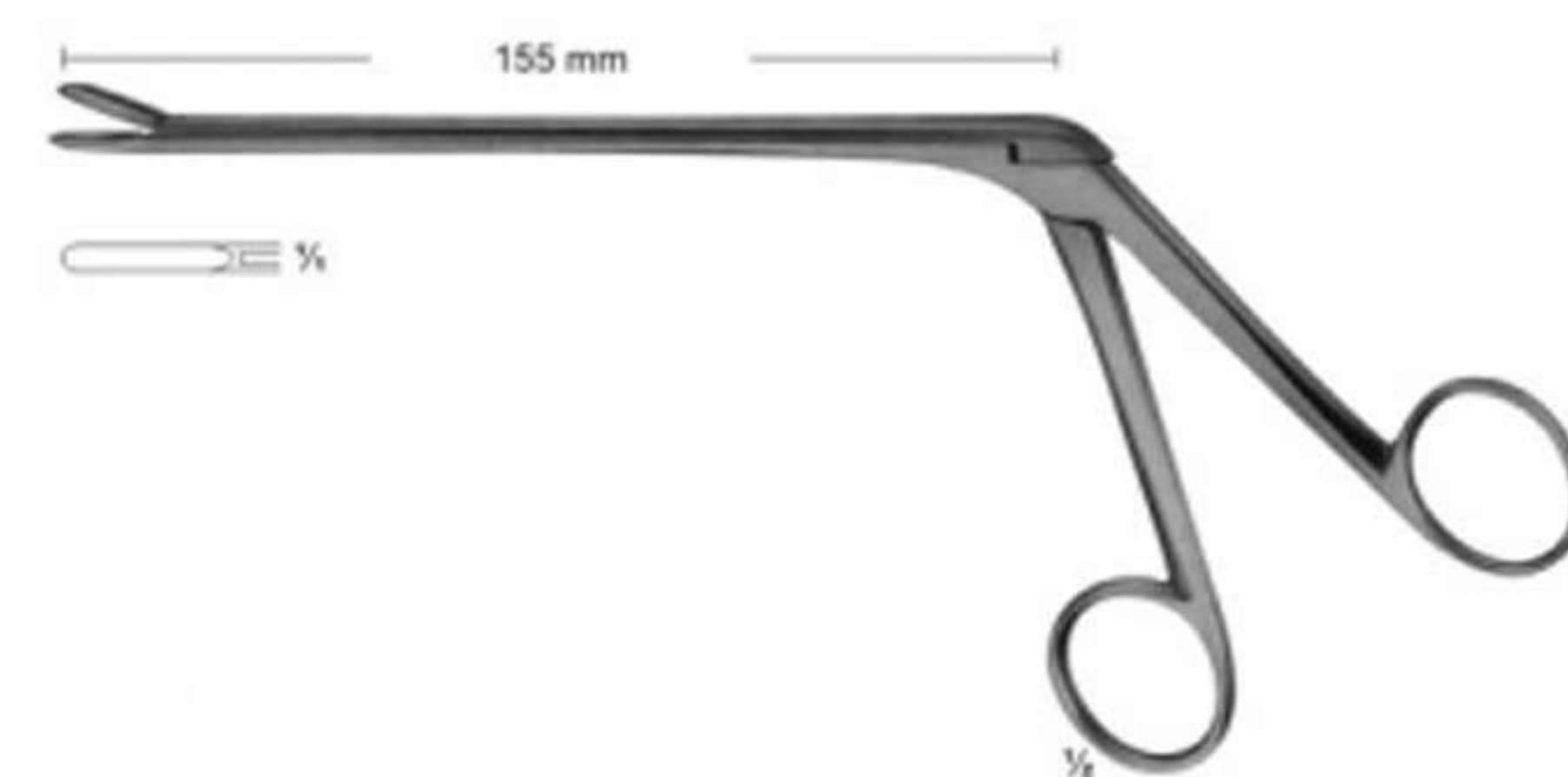

DMI-1-2918
CASPAR 2 mm

Bone Punches, Rongeurs

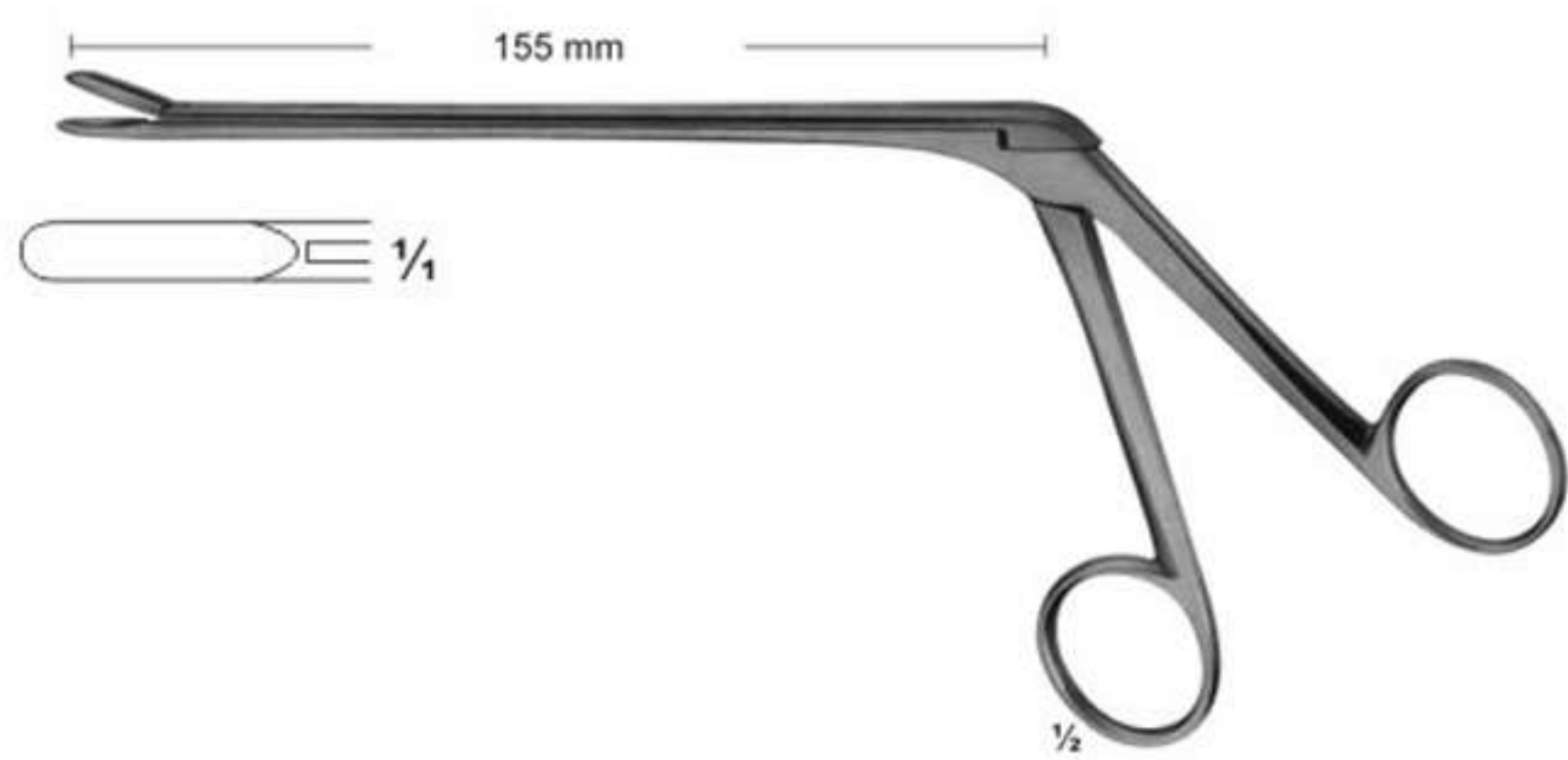

DMI-1-2919
CASPAR 3 mm

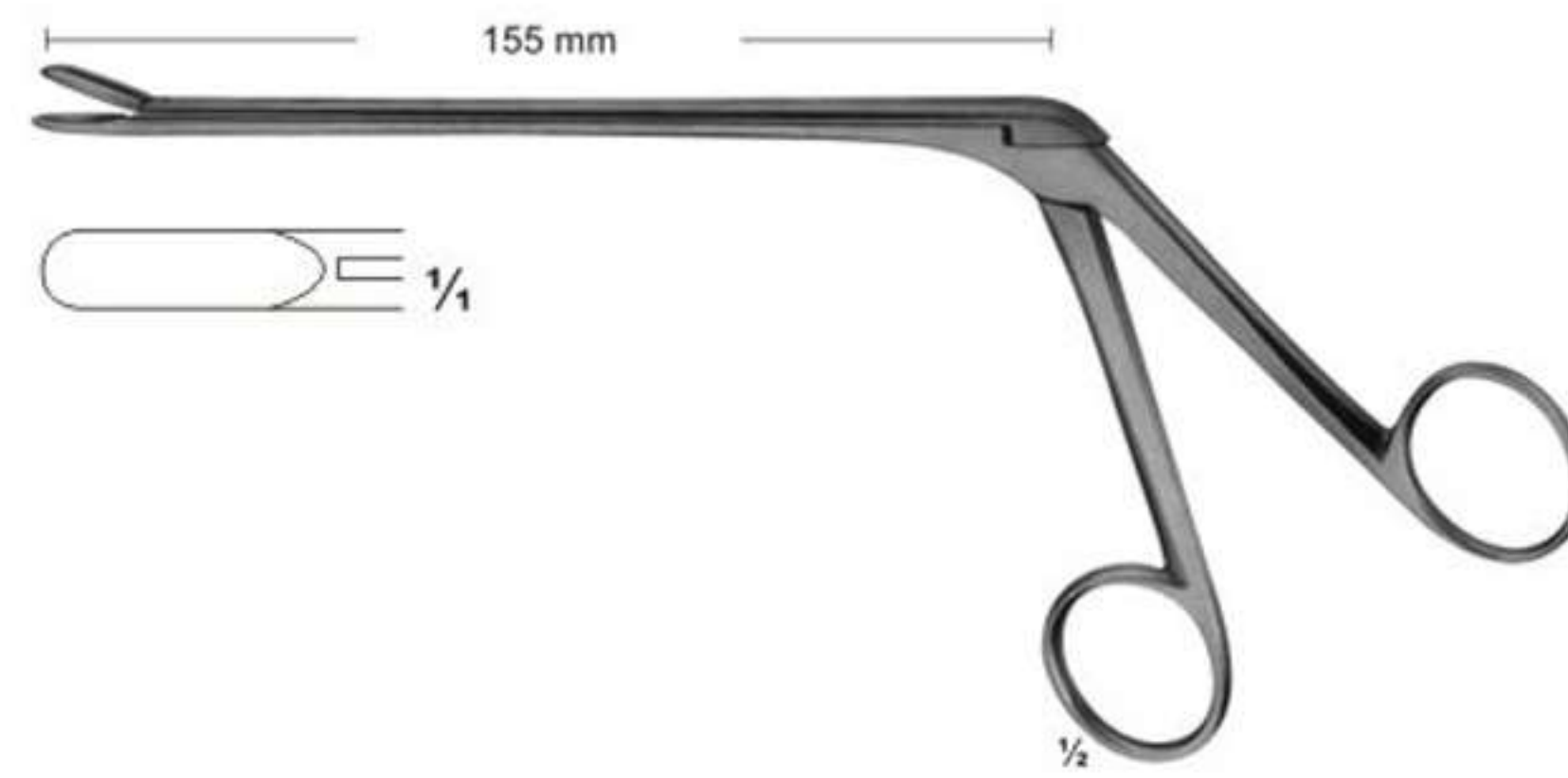

DMI-1-2920
CASPAR 3 mm

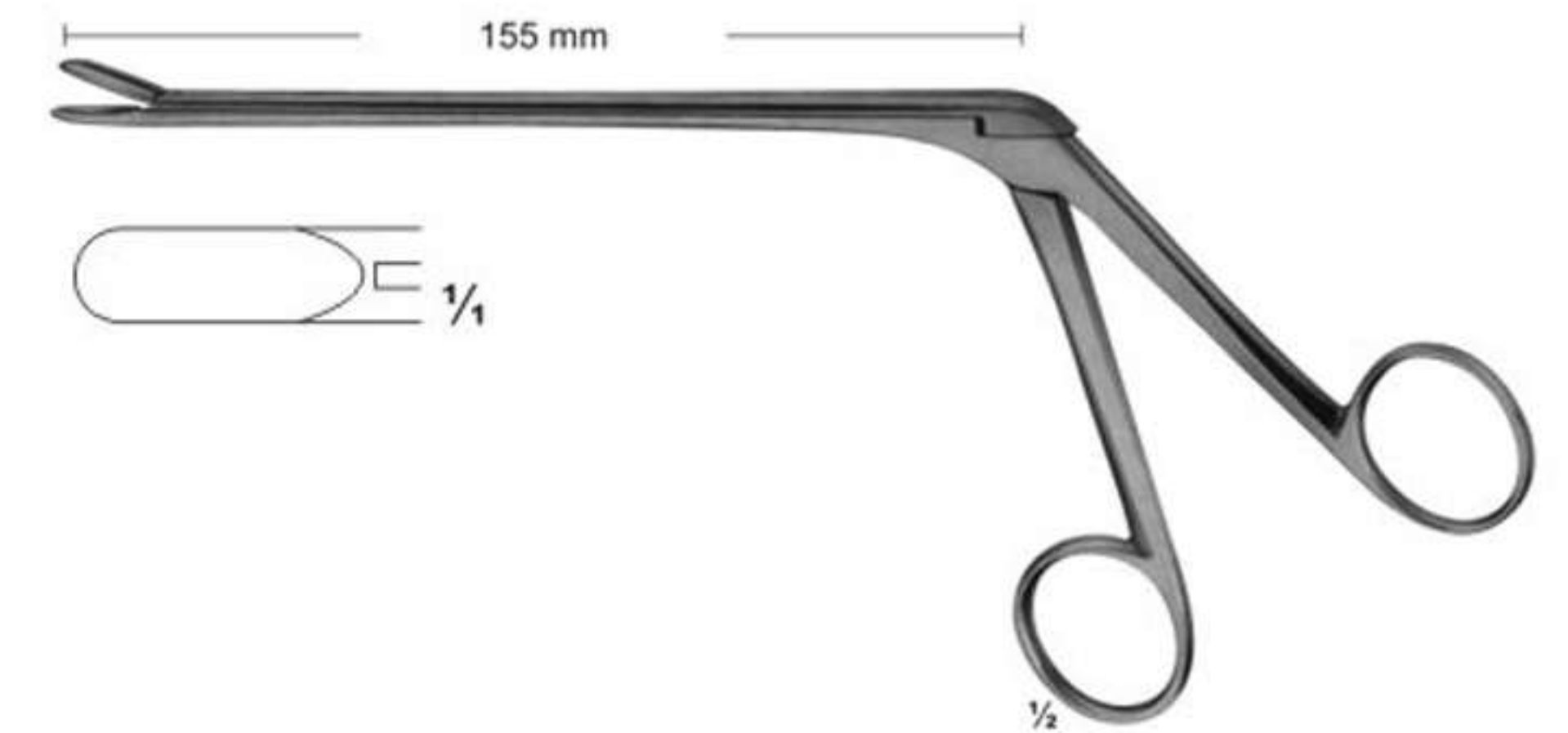

DMI-1-2921
CASPAR 4 mm

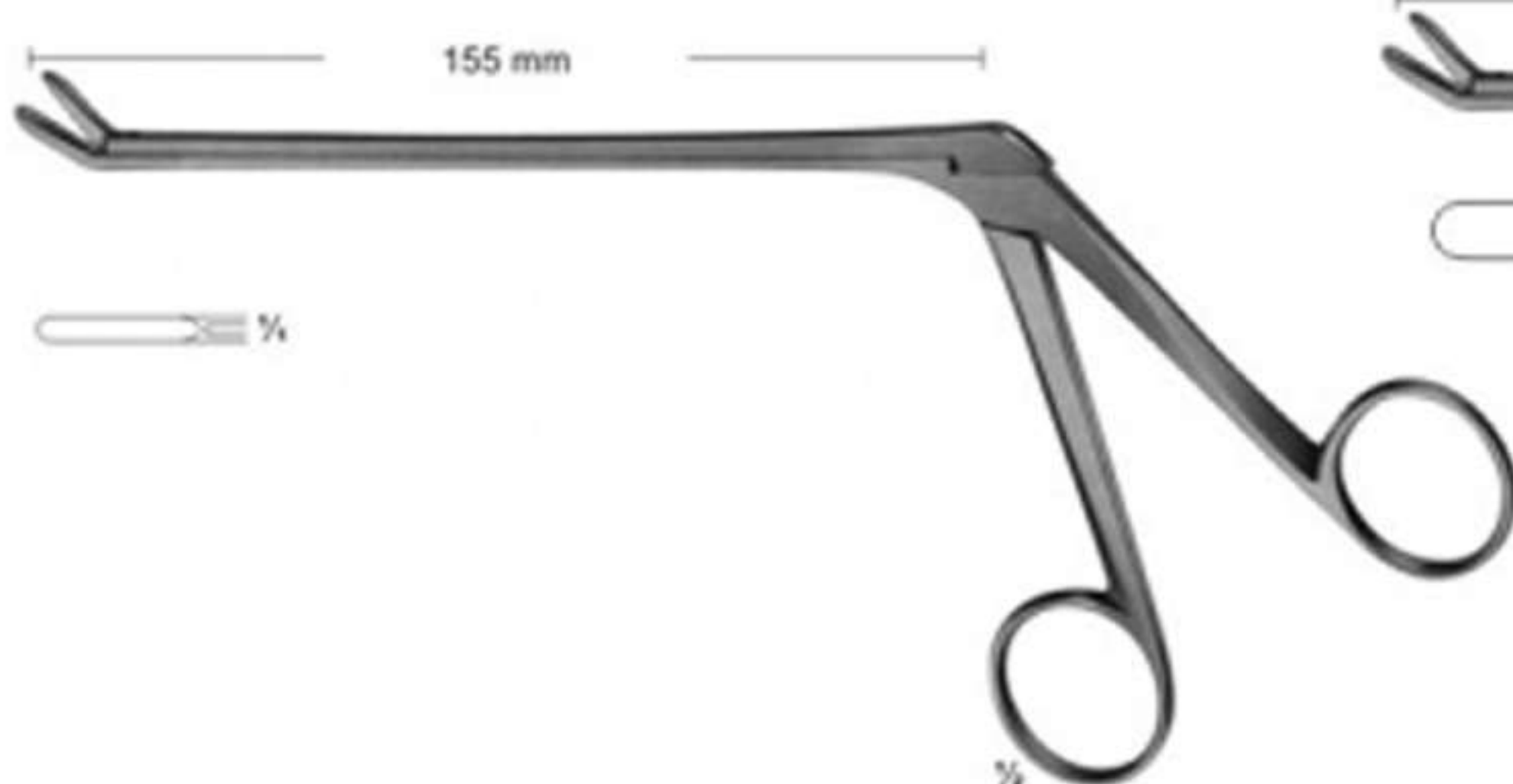

DMI-1-2922
CASPAR 2 mm

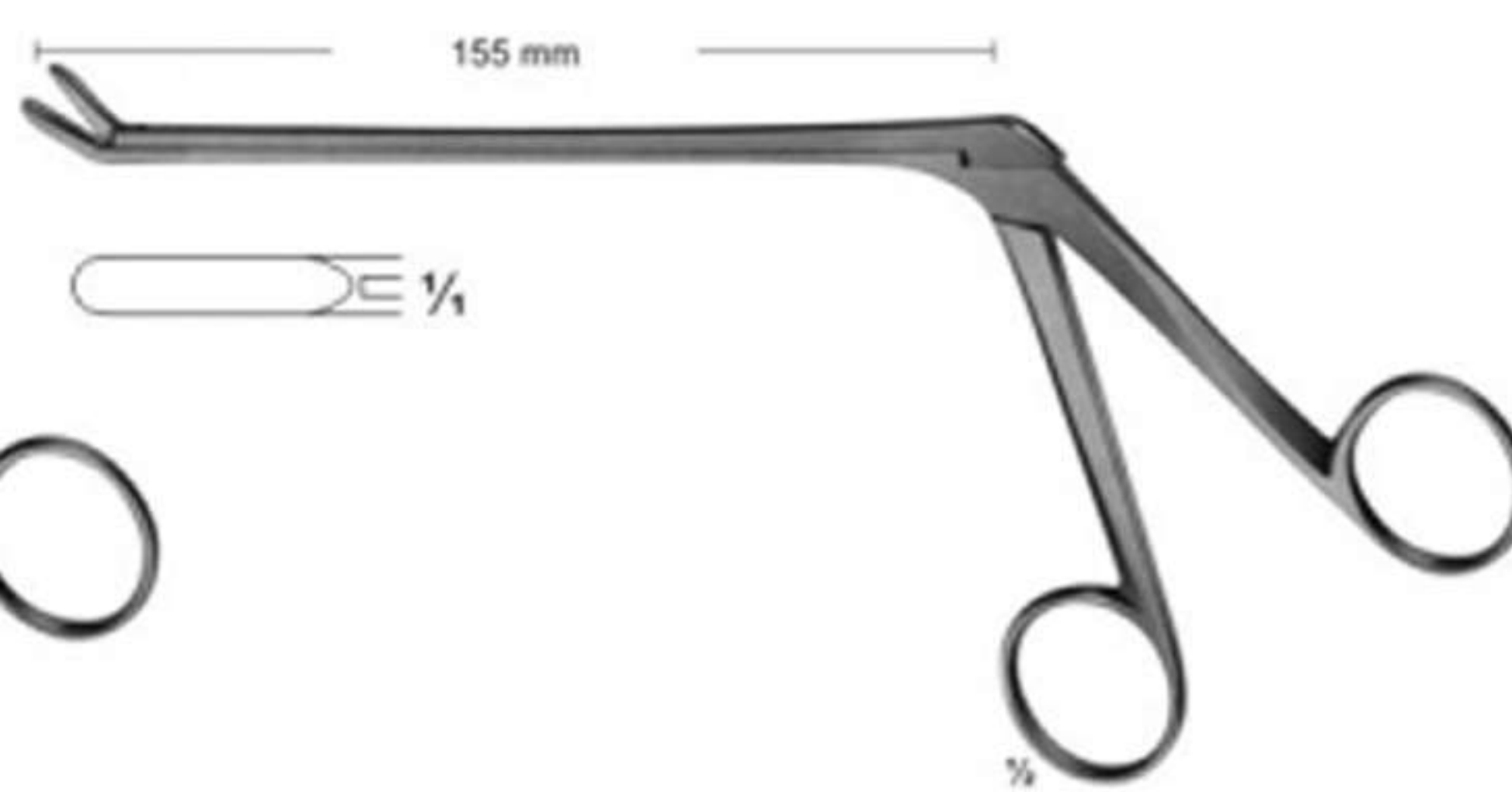

DMI-1-2923
CASPAR 3 mm

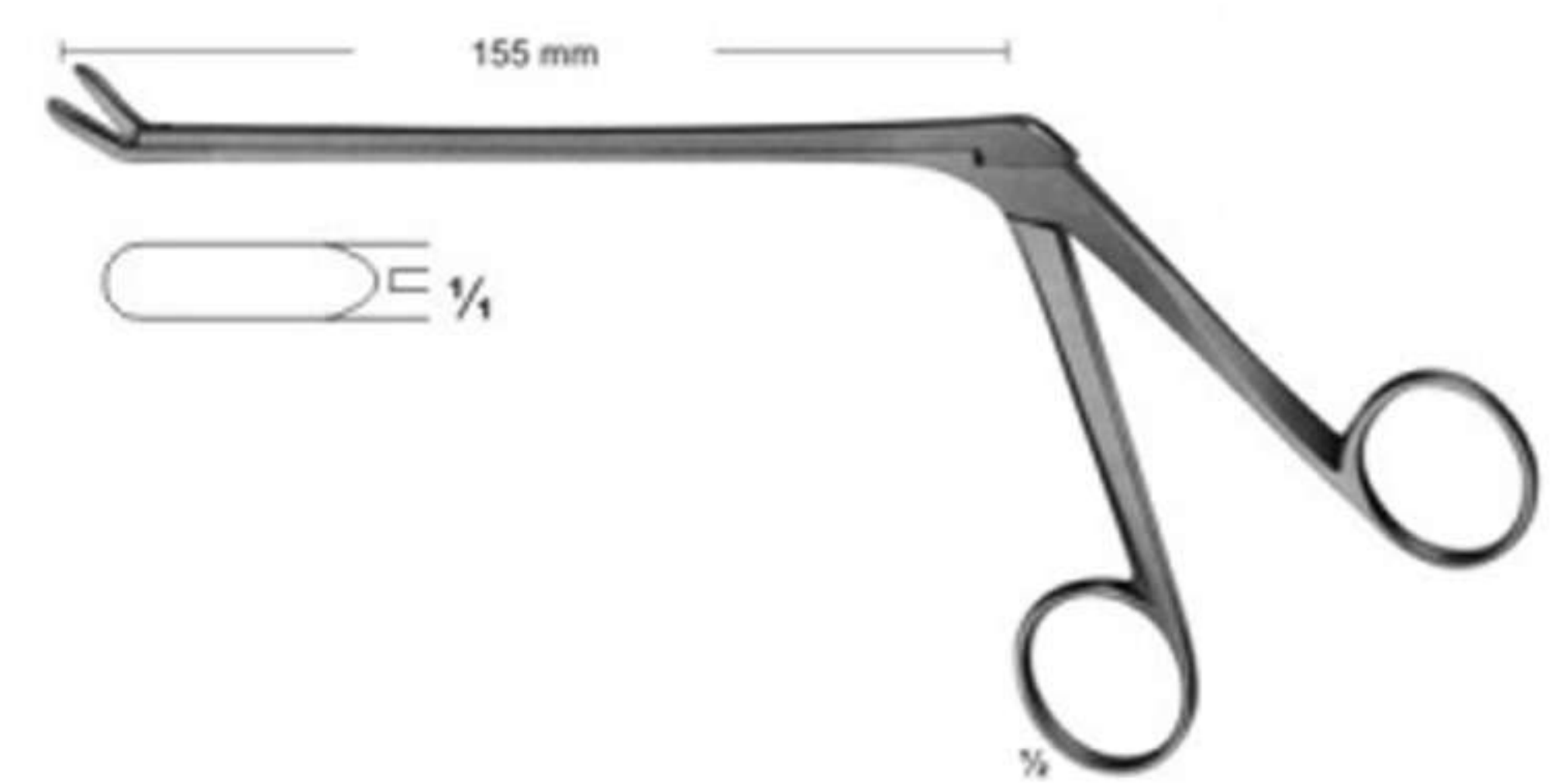

DMI-1-2924
CASPAR 4 mm

Bone Punches, Rongeurs

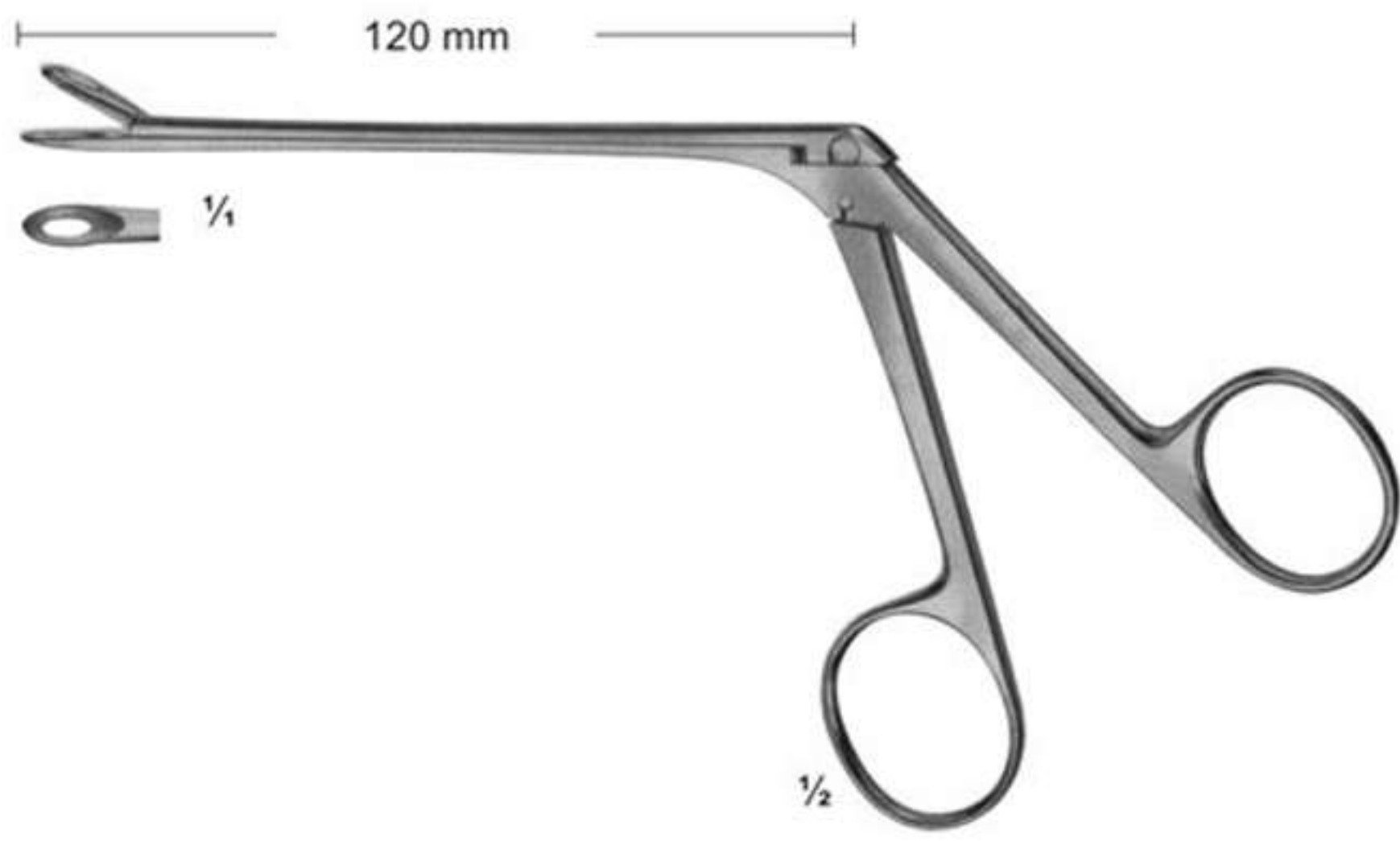

DMI-1-2925
WEIL-BLAKESLEY

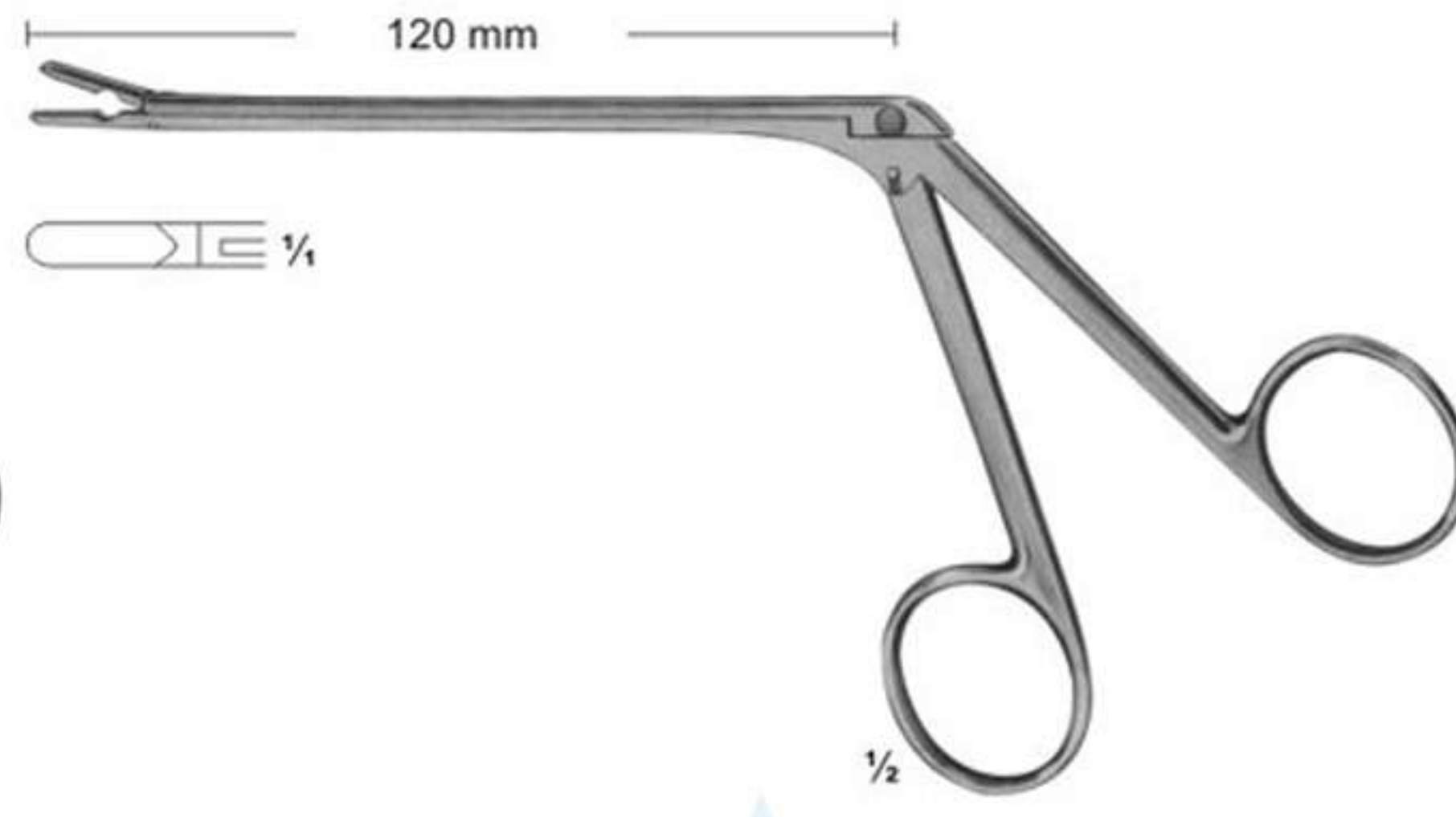

DMI-1-2926
TAKAHASHI 3 mm

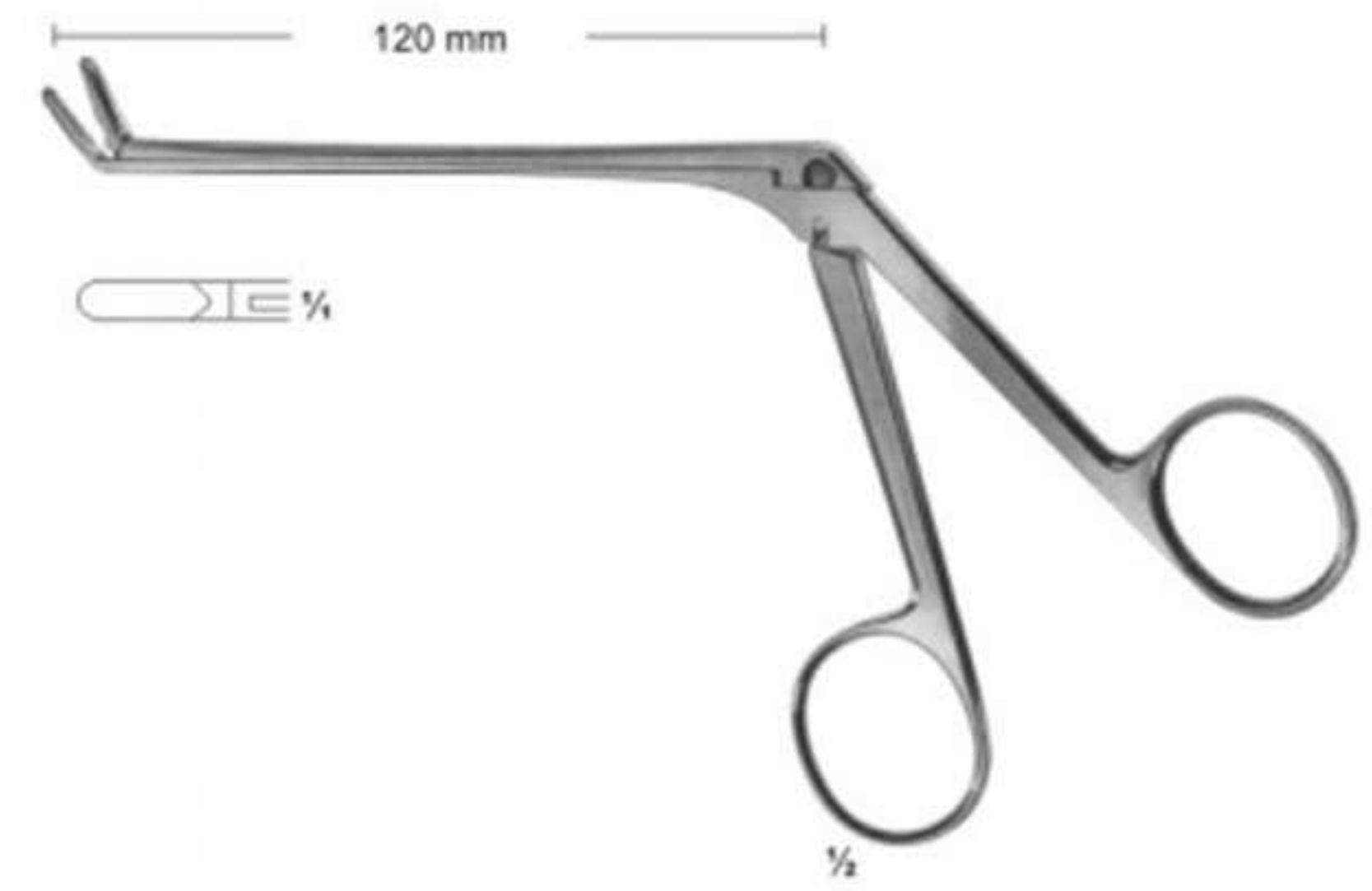

DMI-1-2927
TAKAHASHI 3 mm

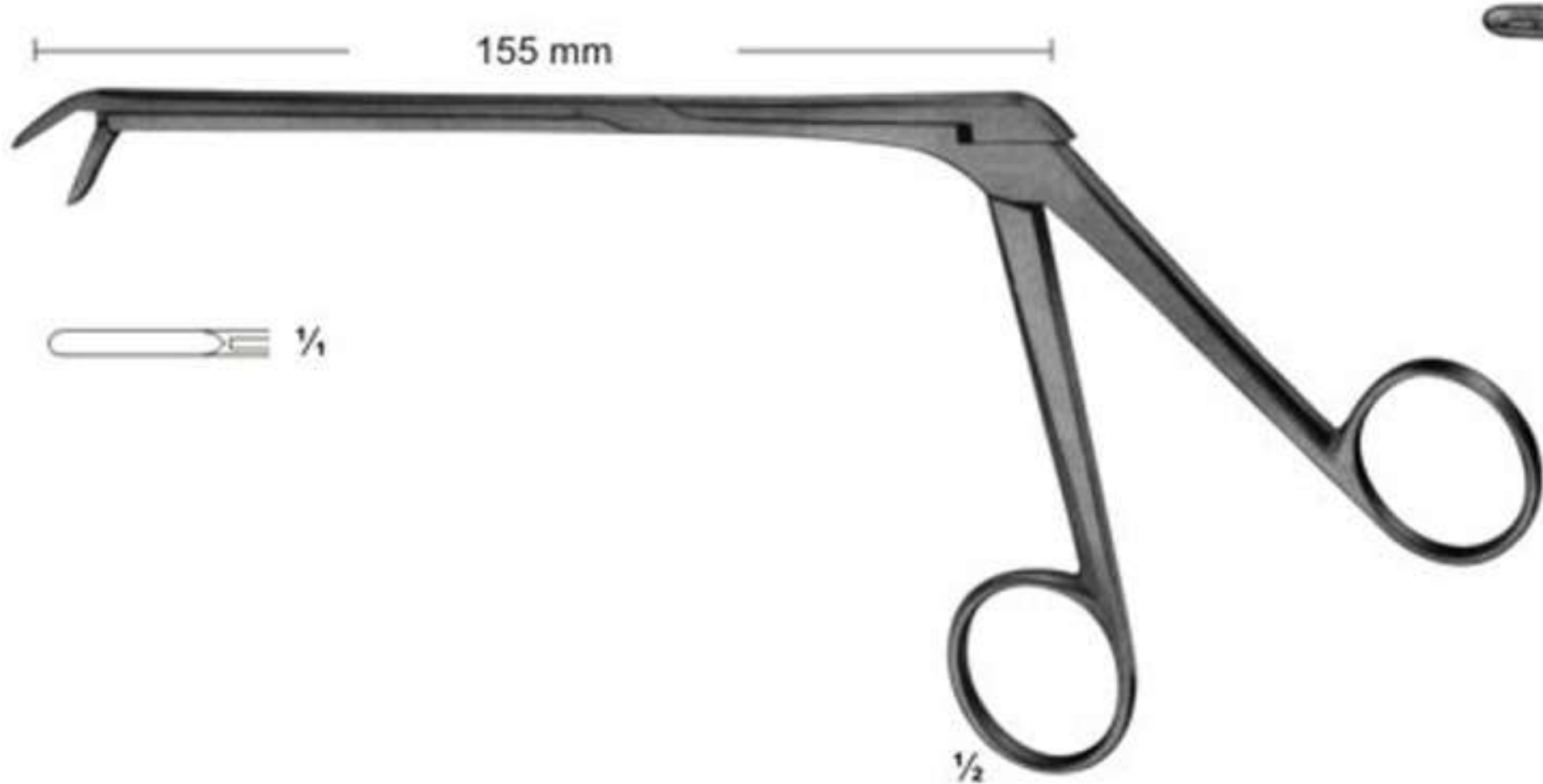

DMI-1-2928
CASPAR

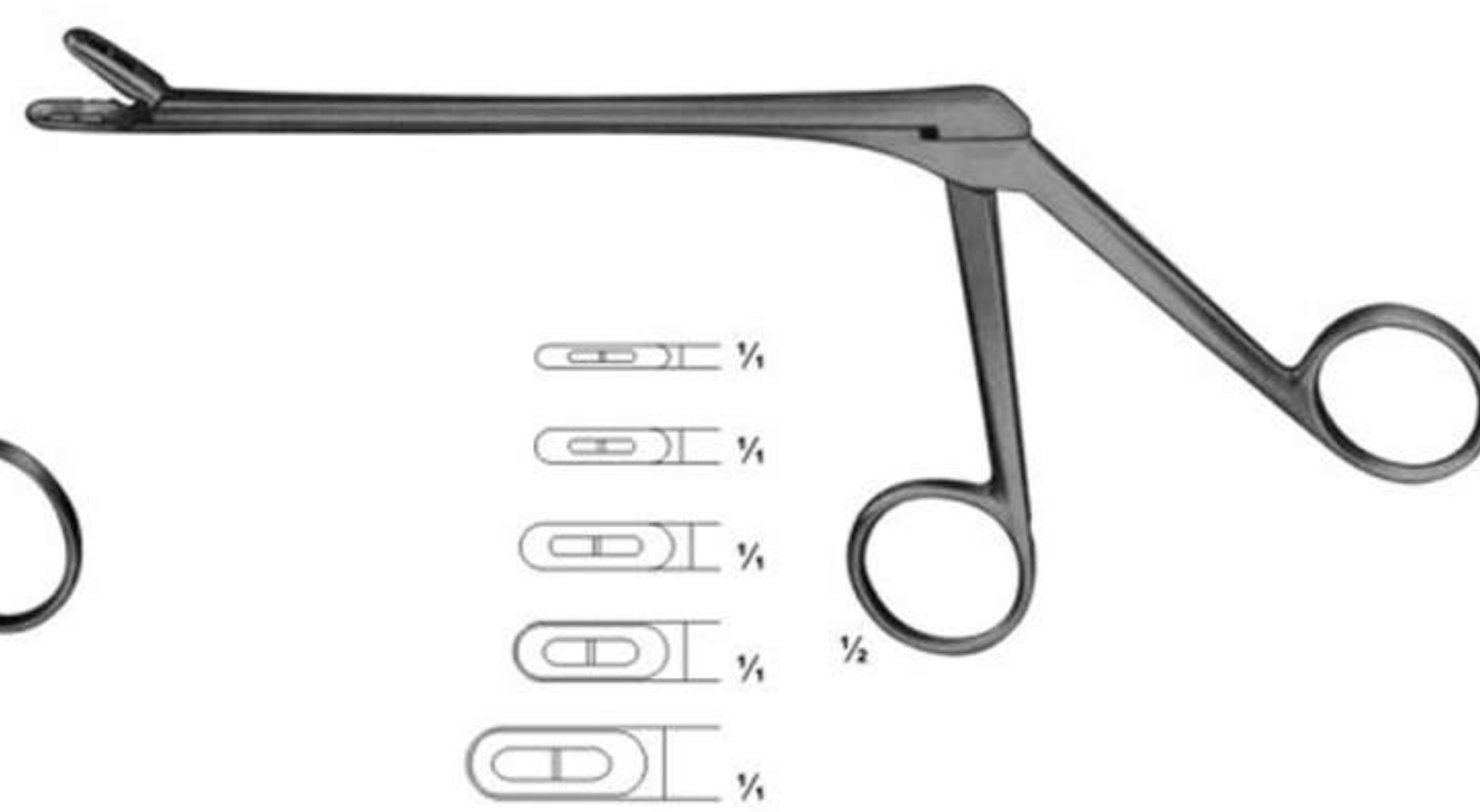

DMI-1-2929
CASPAR



DMI-1-2930
CASPAR

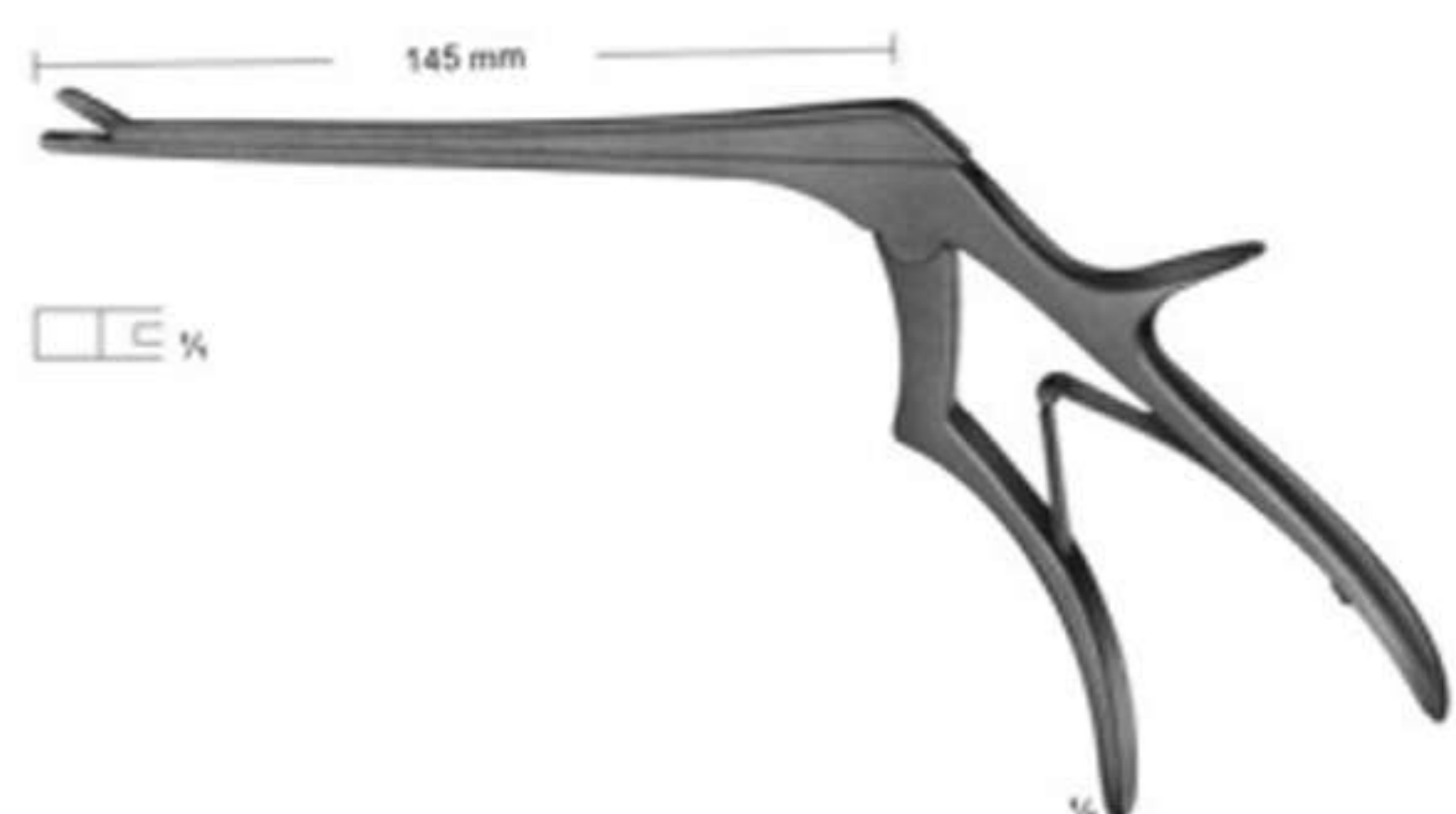

DMI-1-2931
CASPAR 180 mm

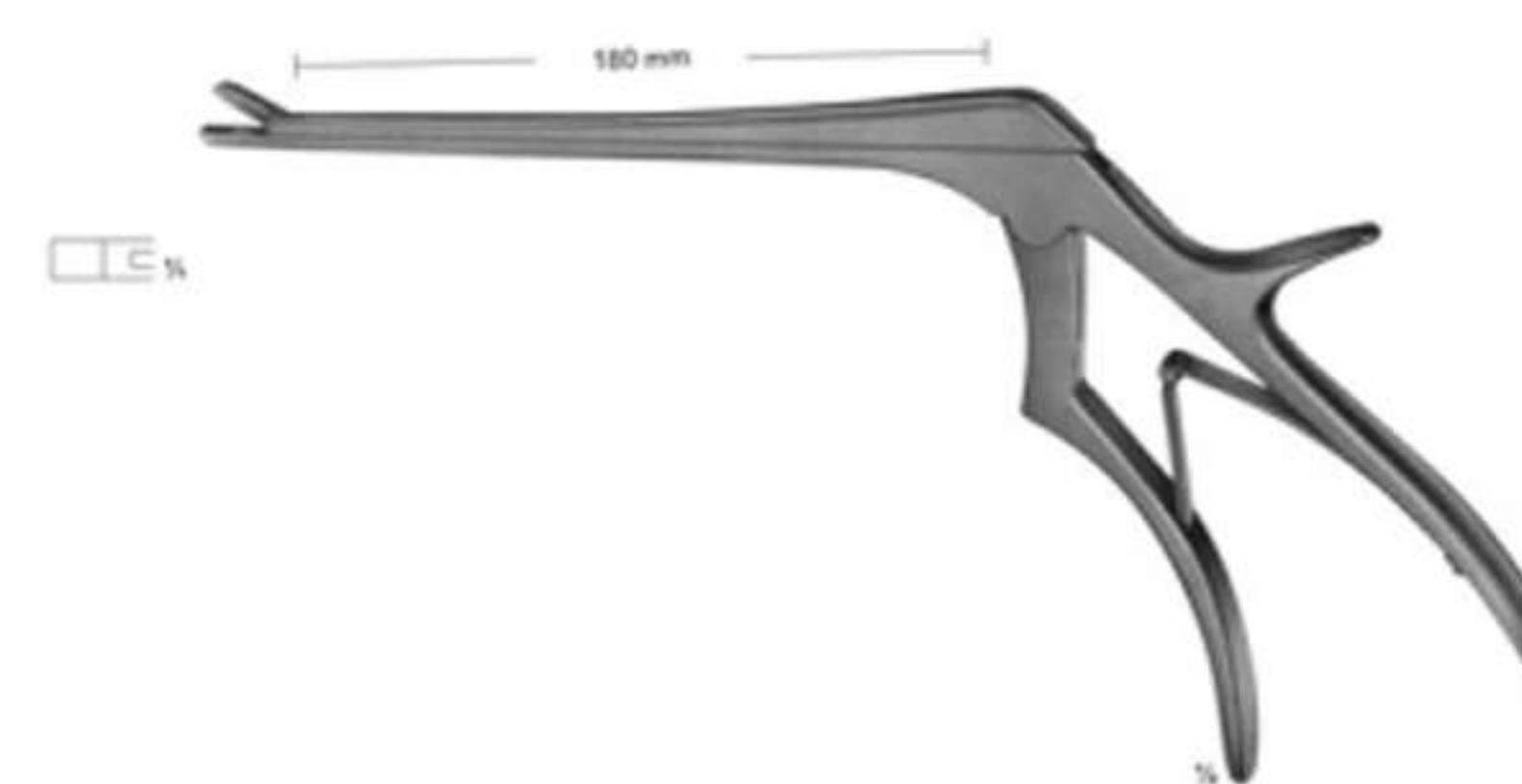

DMI-1-2932
CASPAR 200 mm



DMI-1-2933
WAGNER 5,5 mm

**Elevators, Bone Levers, Raspatories,
Bone Files, Bone Curettes**

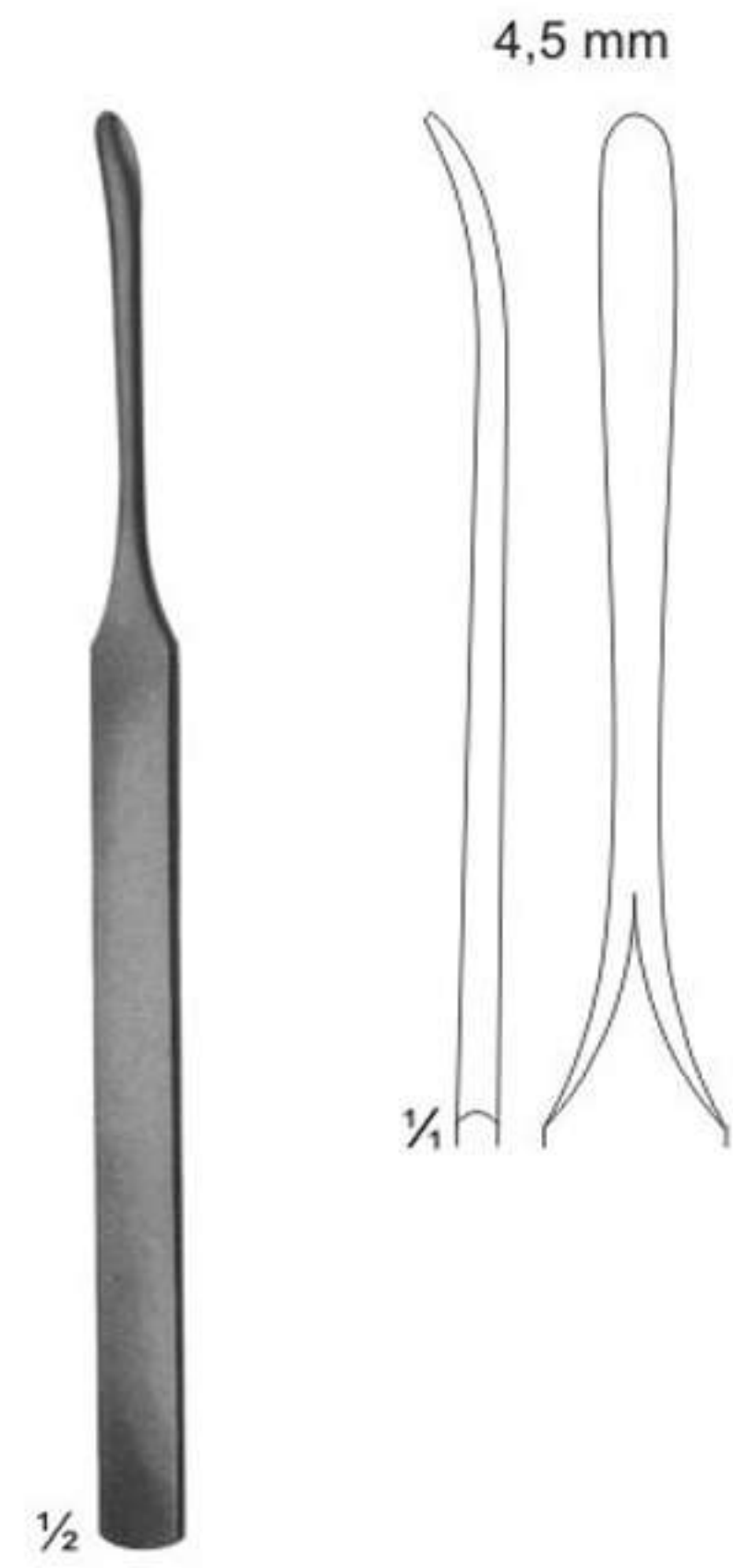

DMI-1-3001
KONIG155 mm

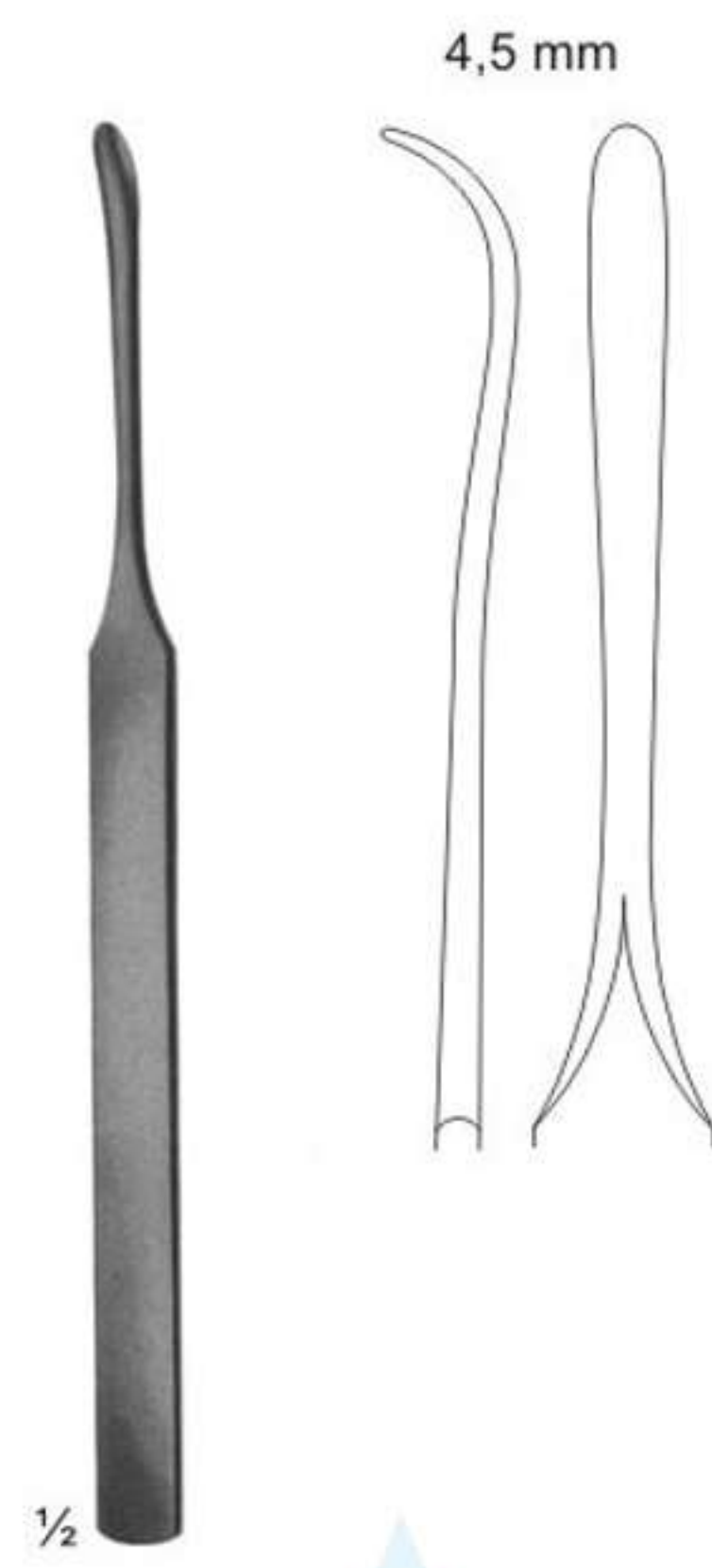

DMI-1-3002
KONIG155 mm



DMI-1-3003
WILLIGER165 mm

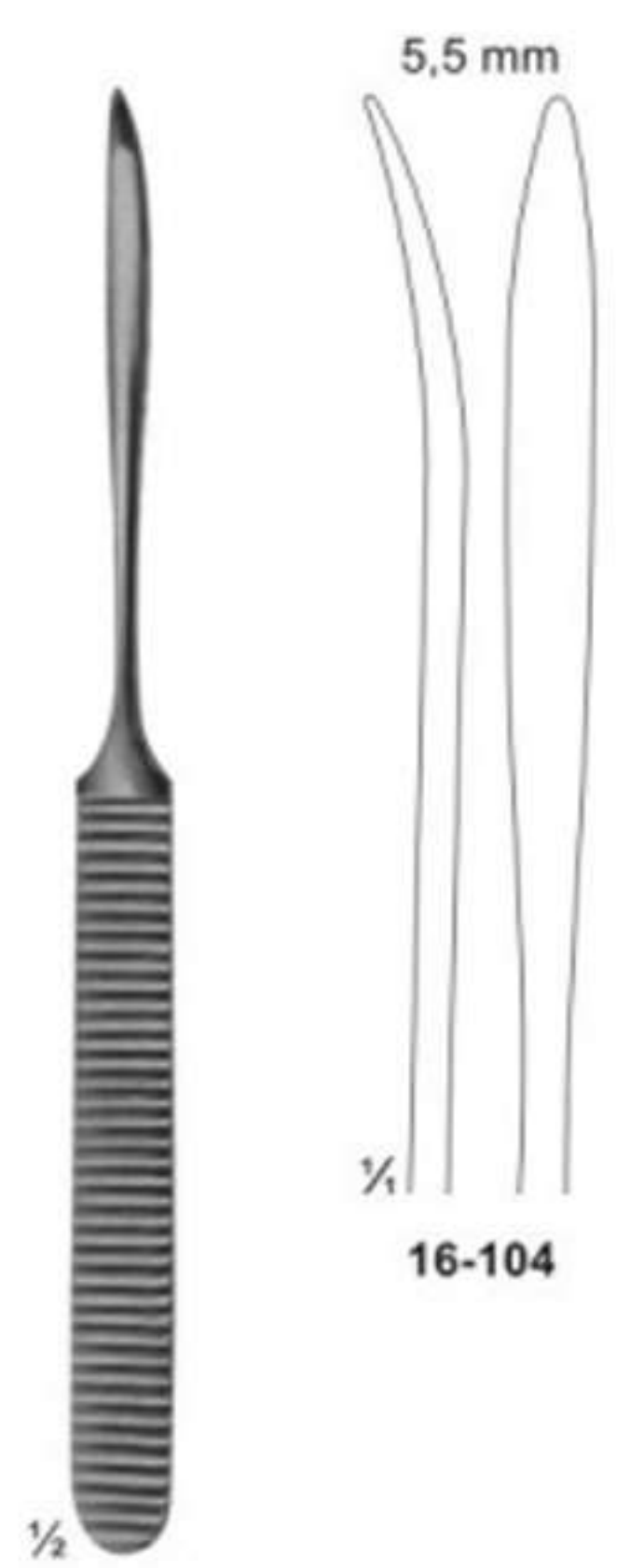

DMI-1-3004
WILLIGER170 mm

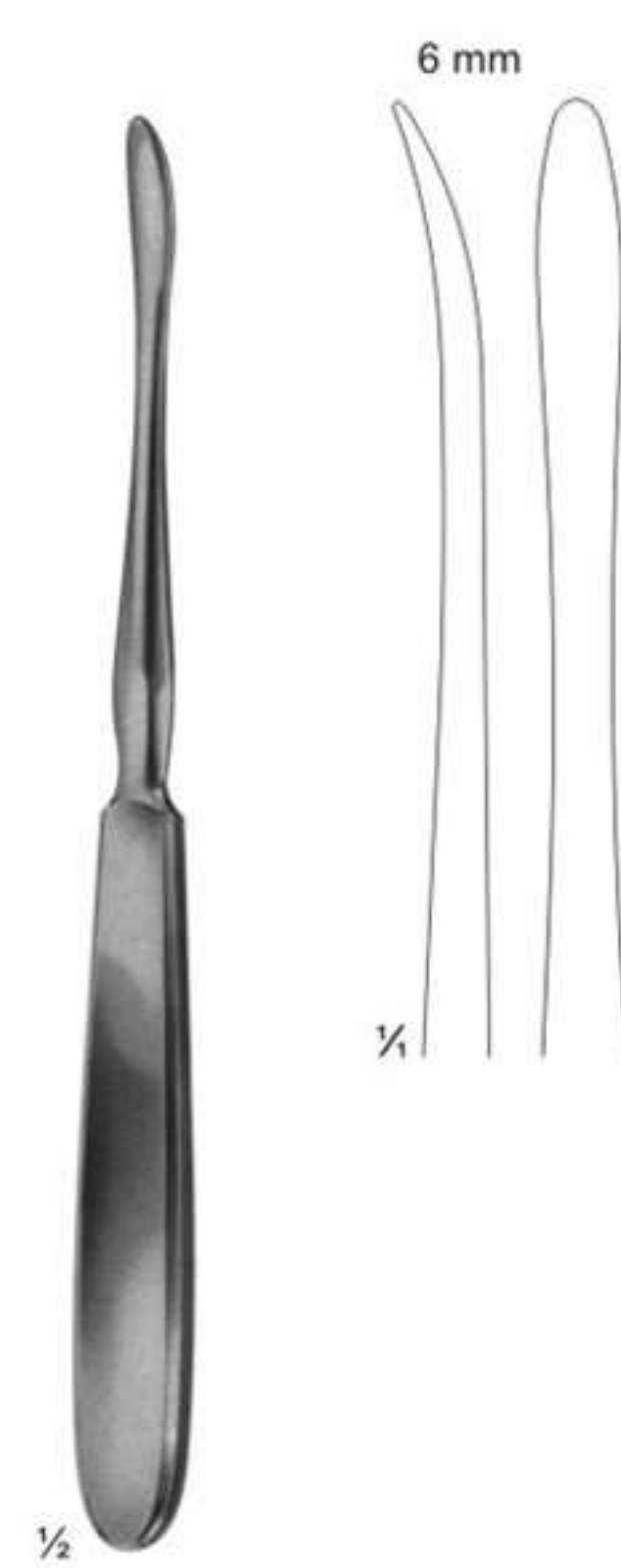

DMI-1-3005
QUERVAIN195 mm



DMI-1-3006
LANGENBACK195 mm

**Elevators, Bone Levers, Raspatories,
Bone Files, Bone Curettes**



DMI-1-3007
LANGENBACK 195 mm

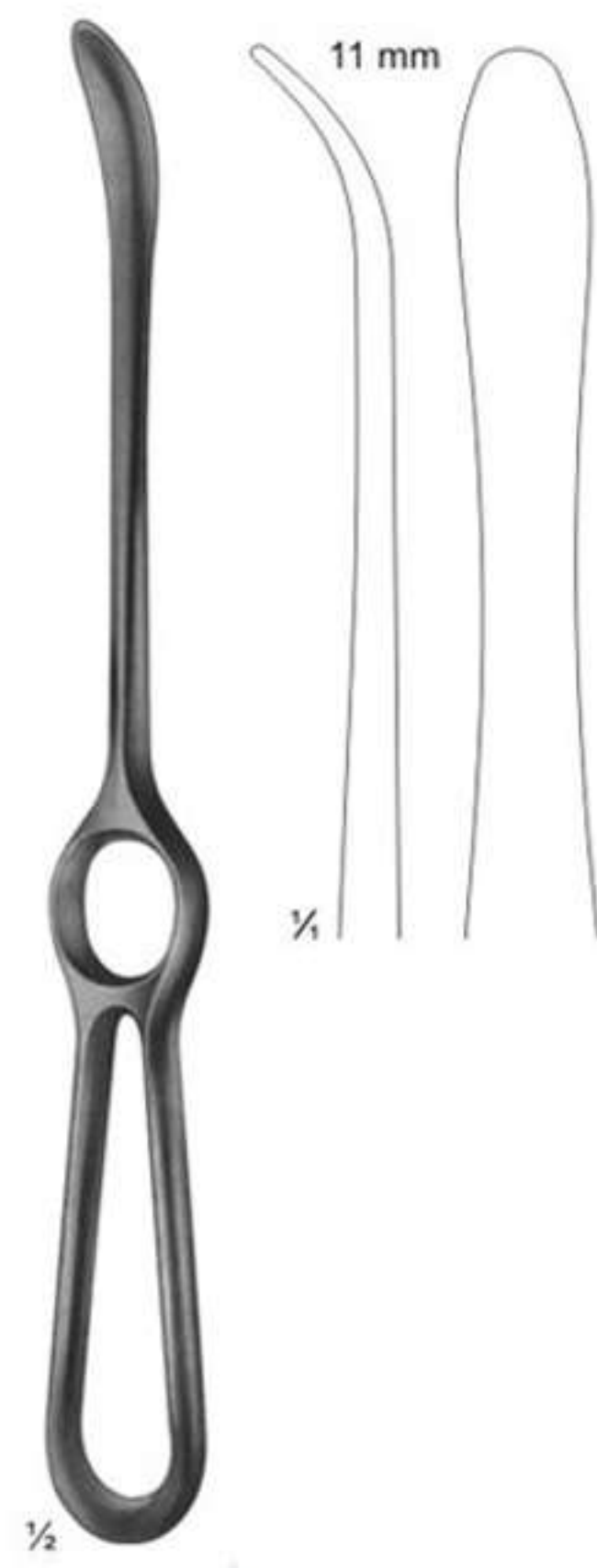

DMI-1-3008
LANGENBACK 230 mm



DMI-1-3009
LANE TRETOWAN 215 mm

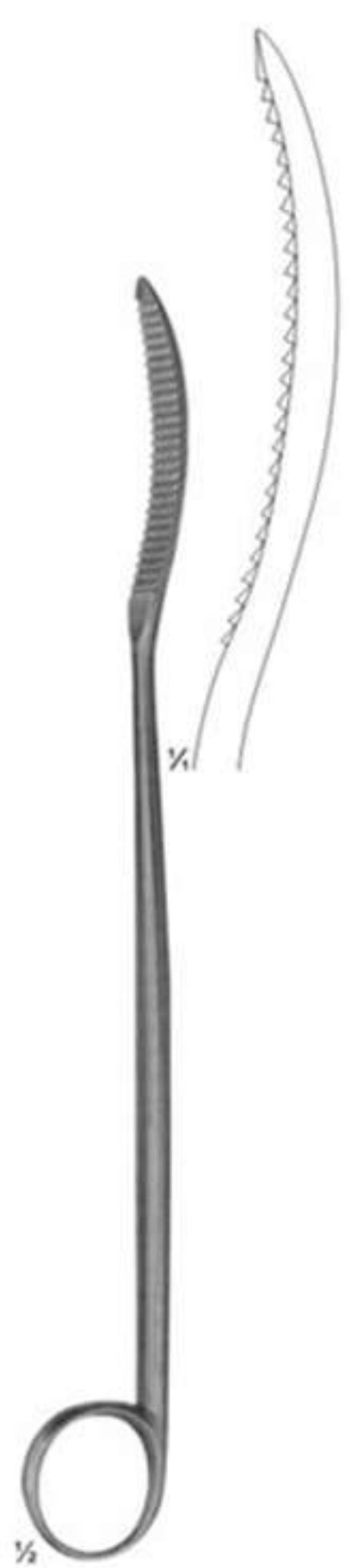

DMI-1-3010
LANE 255 mm



DMI-1-3011
LANGE-HOHMANN 250 mm

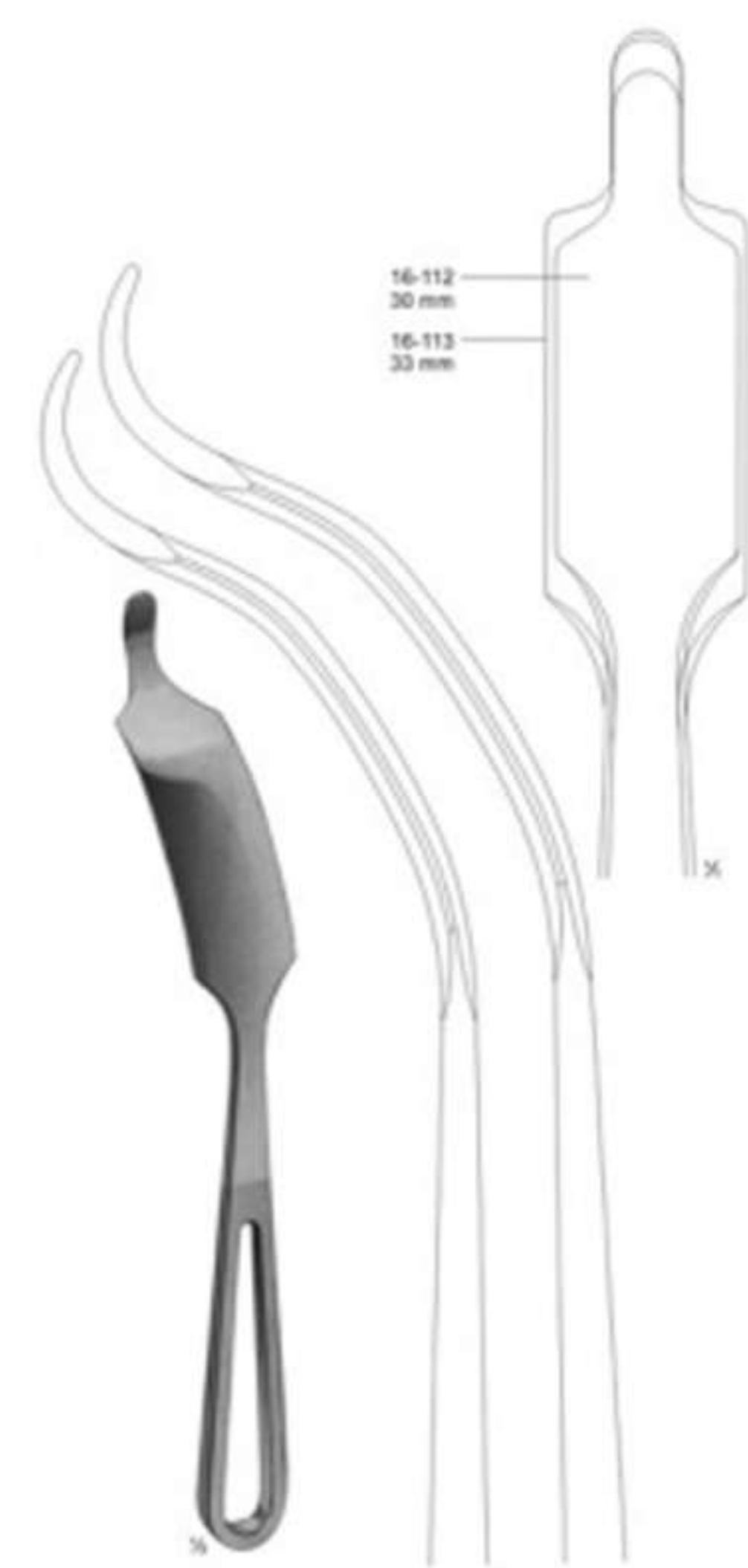

DMI-1-3012
LANGE-HOHMANN modif. 16-112 265 mm
16-113 280 mm

**Elevators, Bone Levers, Raspatories,
Bone Files, Bone Curettes**

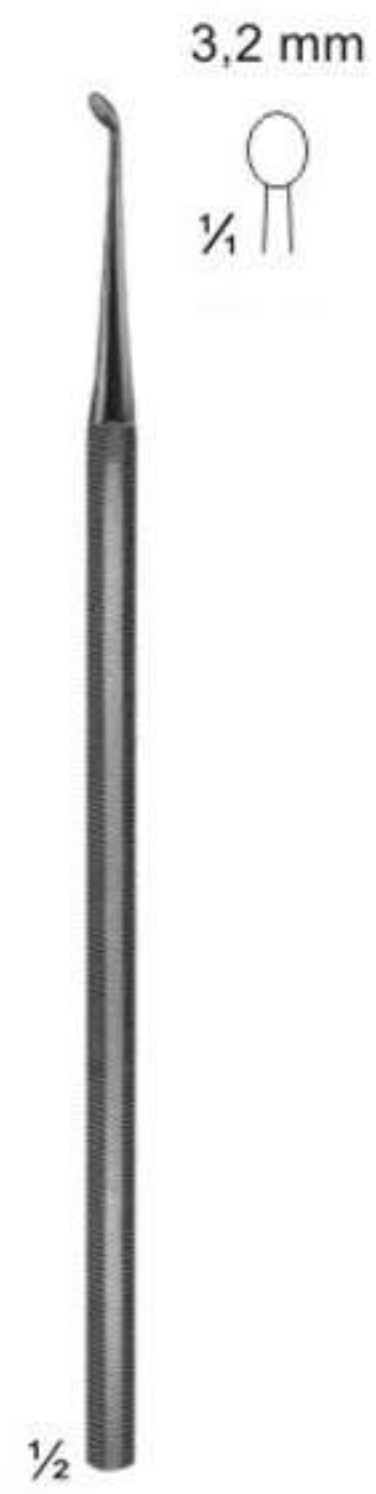

ART-DMI-1-3013
PARTSCH 150 mm



ART-DMI-1-3014
PARTSCH mod. LANGE 145 mm



ART-DMI-1-3015
MC KENTY 155 mm

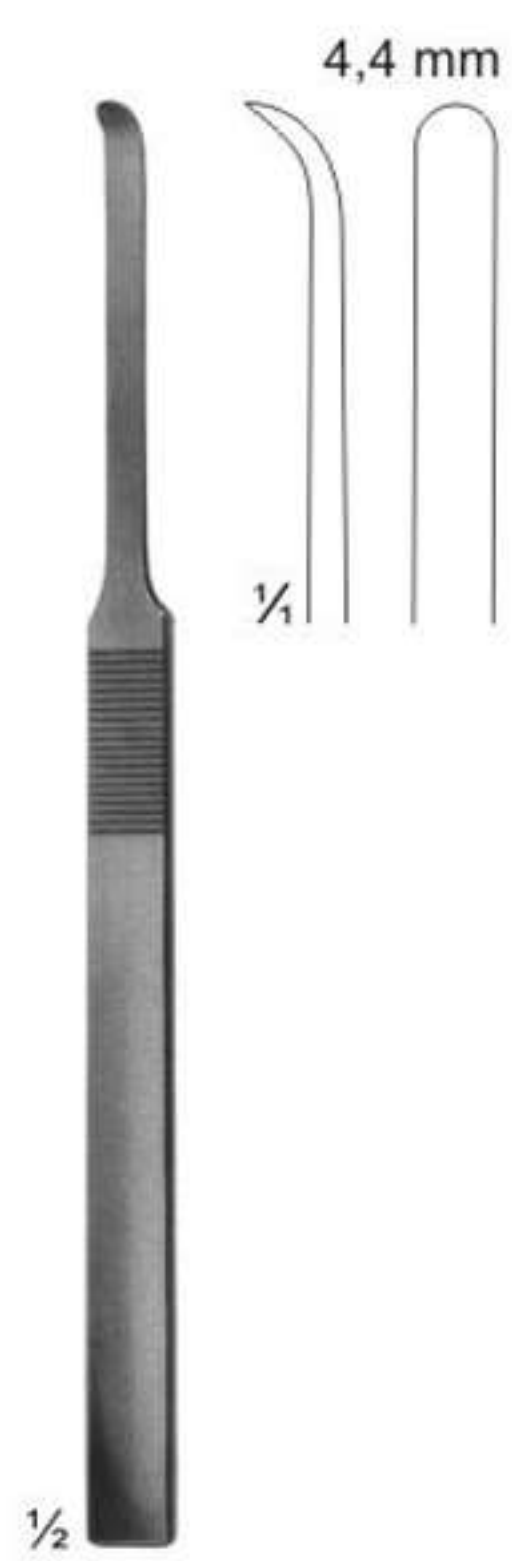

ART-DMI-1-3016
KOENIG 155 mm

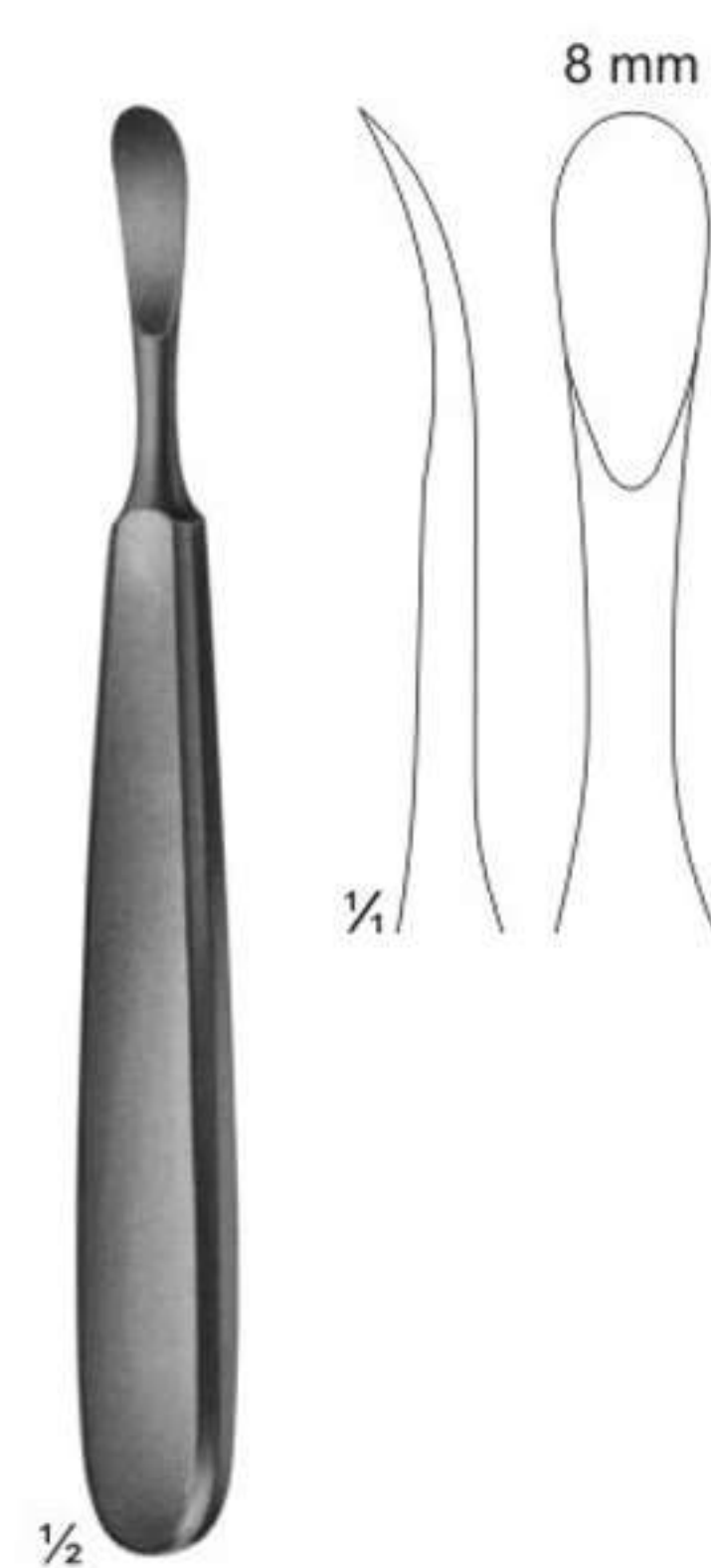

ART-DMI-1-3017
TRELAT 150 mm

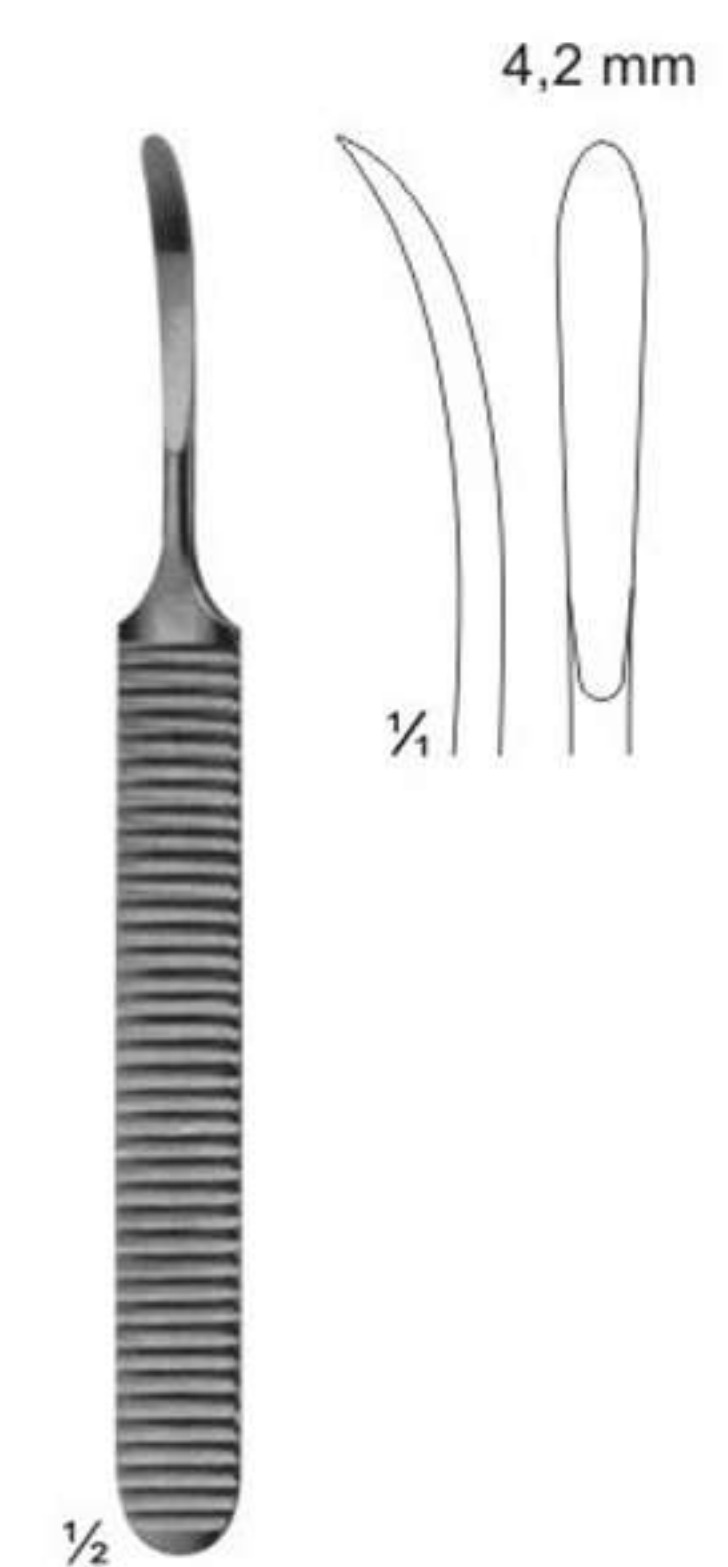

ART-DMI-1-3018
WILLIGER 140 mm

**Elevators, Bone Levers, Raspatories,
Bone Files, Bone Curettes**



DMI-1-3019
WILLIGER 160 mm

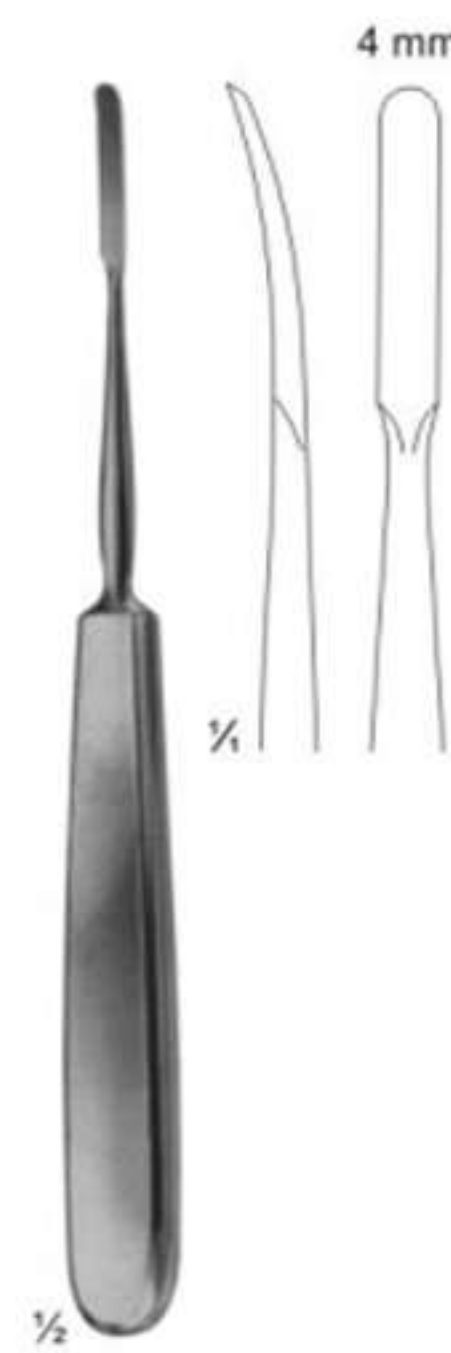

DMI-1-3020
JOSEPH 170 mm

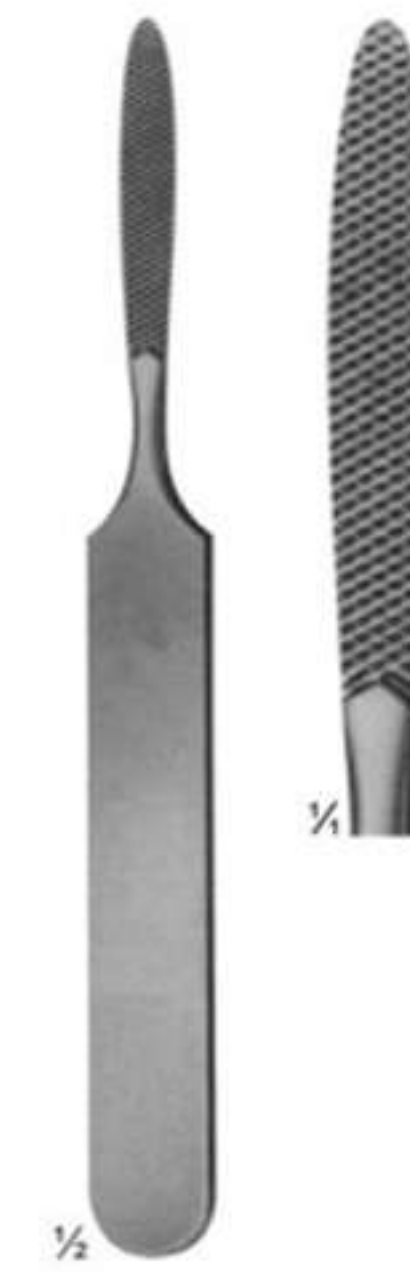

DMI-1-3021
JOSEPH fine, chequered



DMI-1-3022
JOSEPH fine, chequered

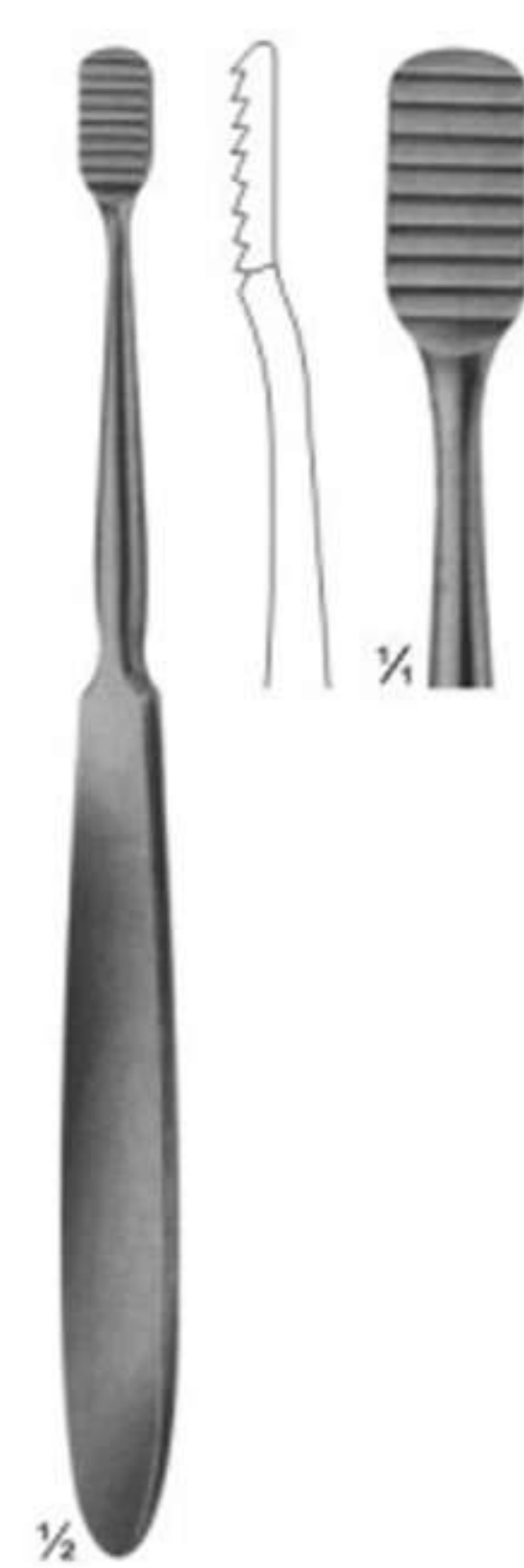

DMI-1-3023
LEWIS 8 mm fine teeth



DMI-1-3024
Coarse Teeth 175 mm

**Elevators, Bone Levers, Raspatories,
Bone Files, Bone Curettes**



DMI-1-3025
GALLAHER 190 mm

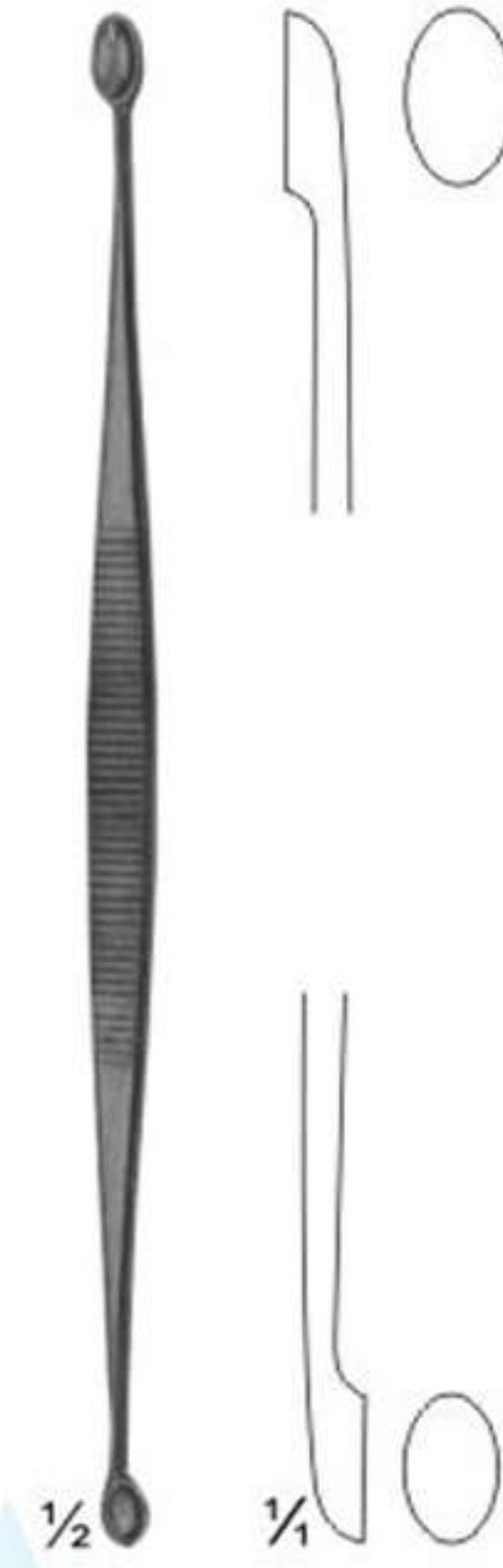

DMI-1-3026
JACOBSON 140 mm



DMI-1-3027
MARTINI 140 mm



DMI-1-3028
MARTINI 140 mm



DMI-1-3029
WILLIGER 145 mm



DMI-1-3030
JANSEN 160 mm

Mallets Chisels and Gouges



DMI-1-3031
BARTH 180 mm

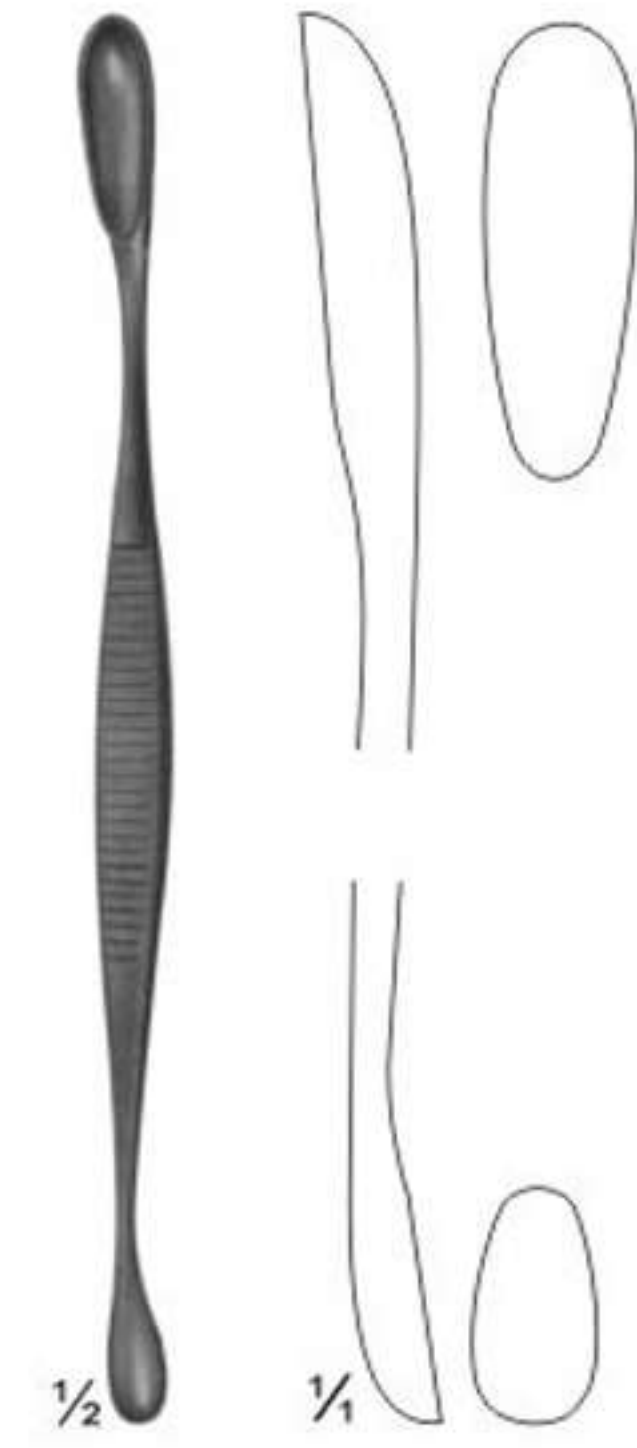

DMI-1-3032
VOLKMANN 130 mm

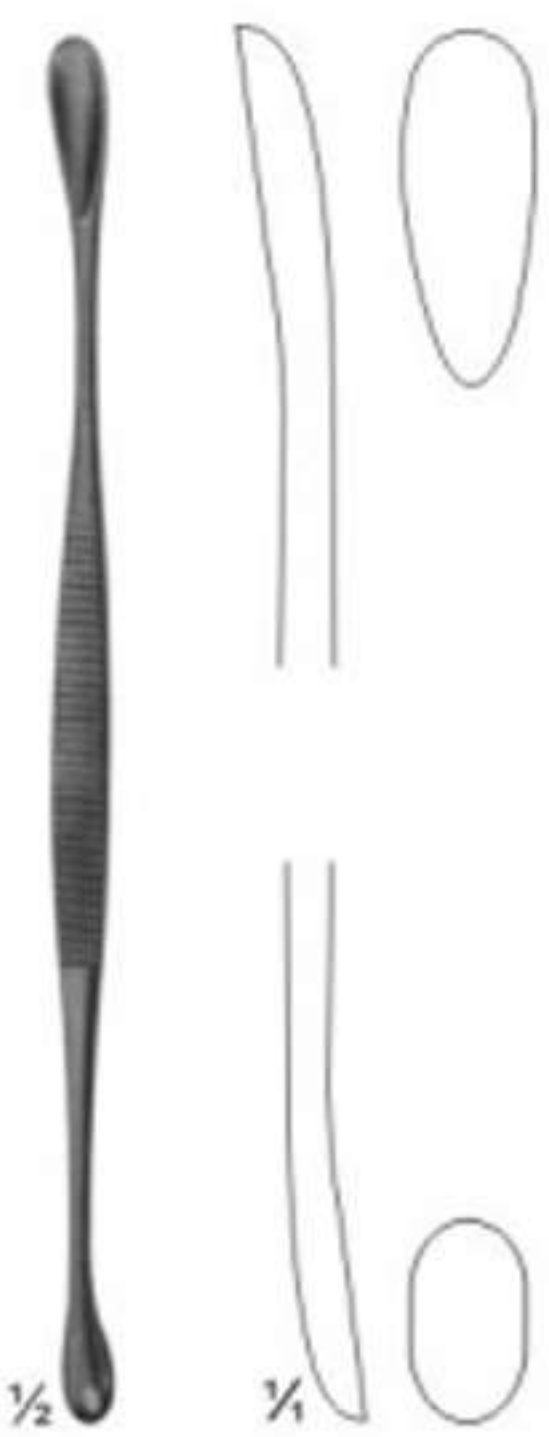

DMI-1-3033
VOLKMANN 145 mm



DMI-1-3034
VOLKMANN 170 mm

Mallets Chisels and Gouges



DMI-1-3101
MEAD 185 g with interchangeable plastic disks 190 mm



DMI-1-3102
17-102 pair of spare disks



DMI-1-3103
140 g with interchangeable plastic disks 185 mm



DMI-1-3104
pair of spare disks



DMI-1-3105
COTTLE 140 g 1 Side Flat 1 Side convex 185 mm



DMI-1-3106
165 g lead filled head 190 mm

Mallets Chisels and Gouges



DMI-1-3107
MANNERFELT Gouge 155 mm



DMI-1-3108
Osteotomes 140 mm

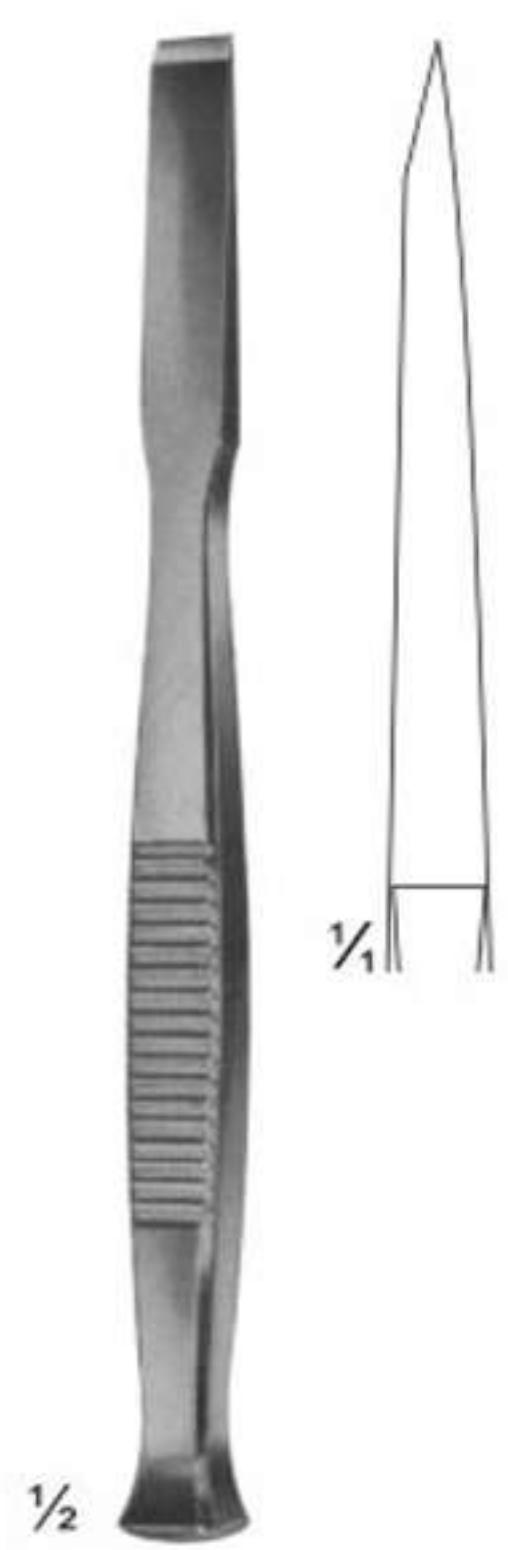

DMI-1-3109
Chisels 140 mm

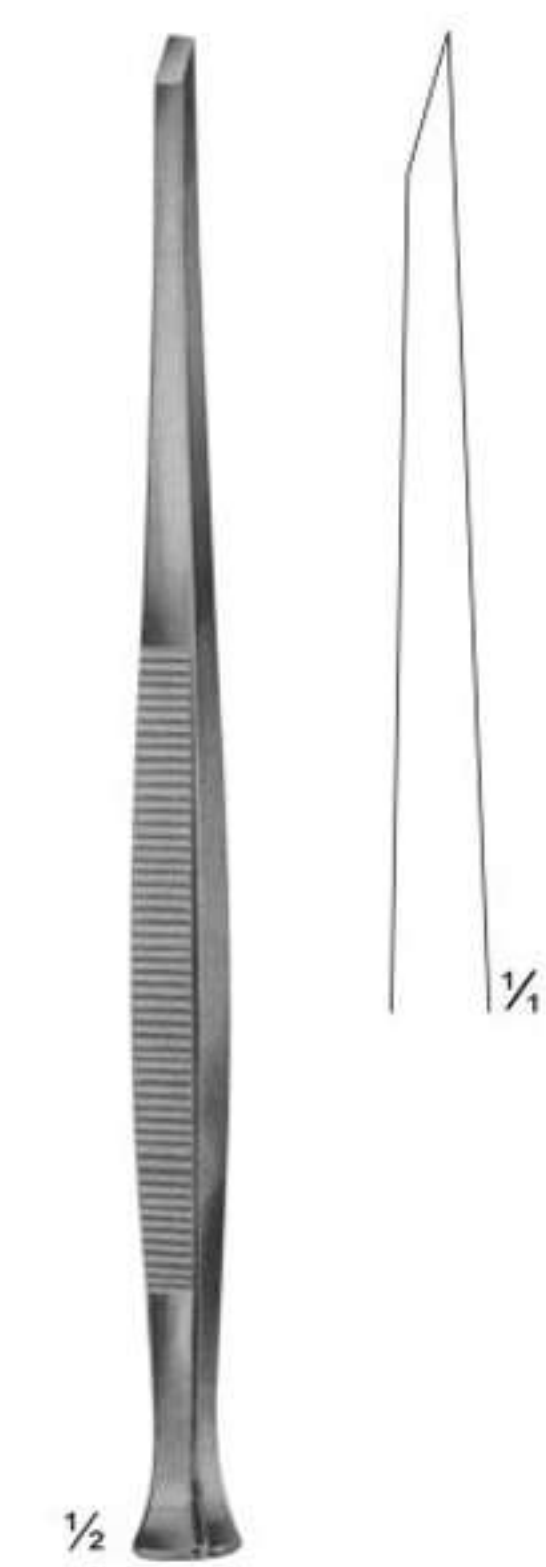

DMI-1-3110
Gouges 140 mm

**Bone Holding Forceps, Bone Rongeurs,
Bone Cutting Forceps**



DMI-1-3201
Patella forceps 185 mm



DMI-1-3202
Forceps with ratchet fixation 140 mm



DMI-1-3203
Forceps with thread fixation 170 mm

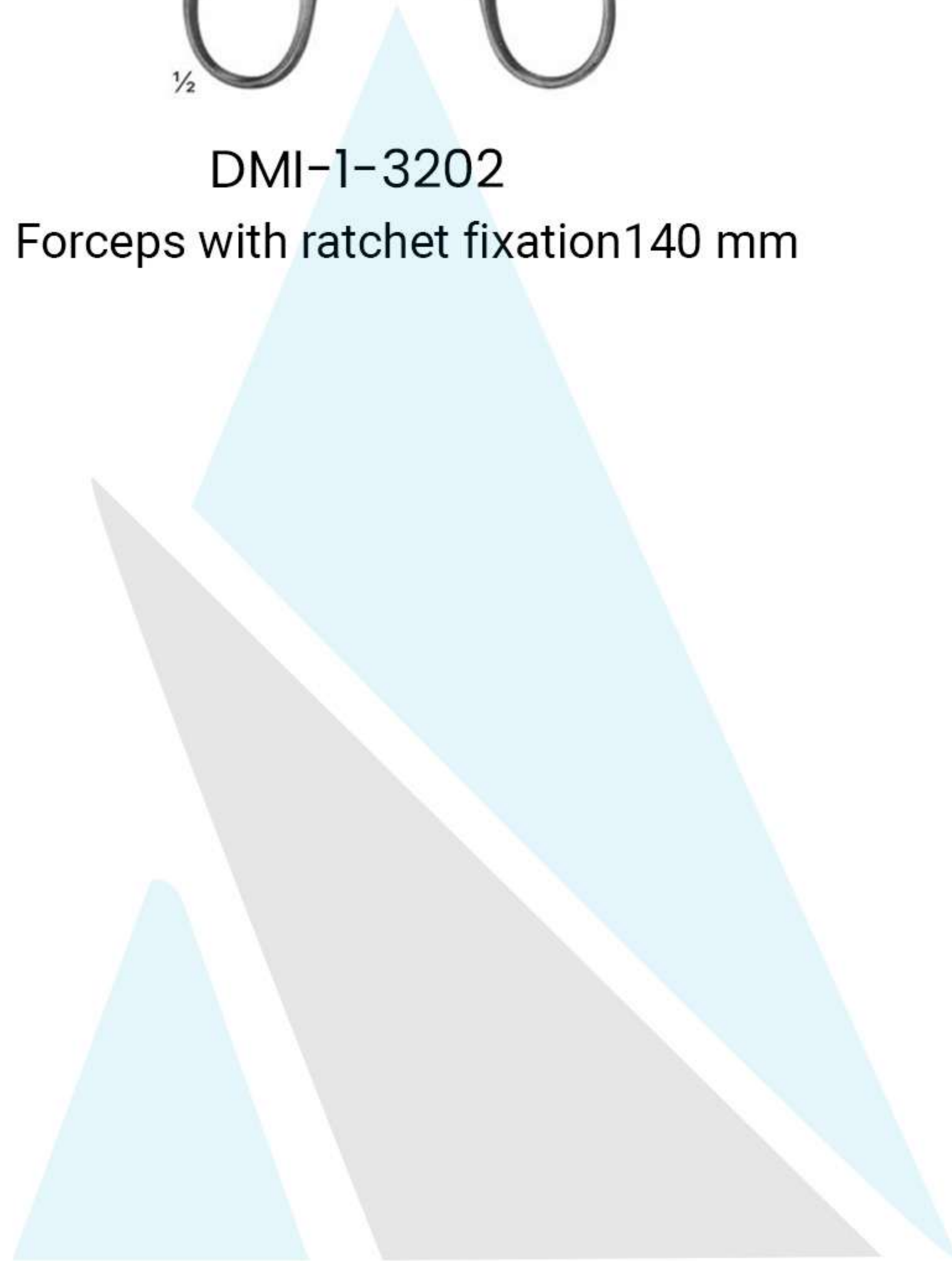

DMI-1-3204
Forceps with thread fixation 235 mm

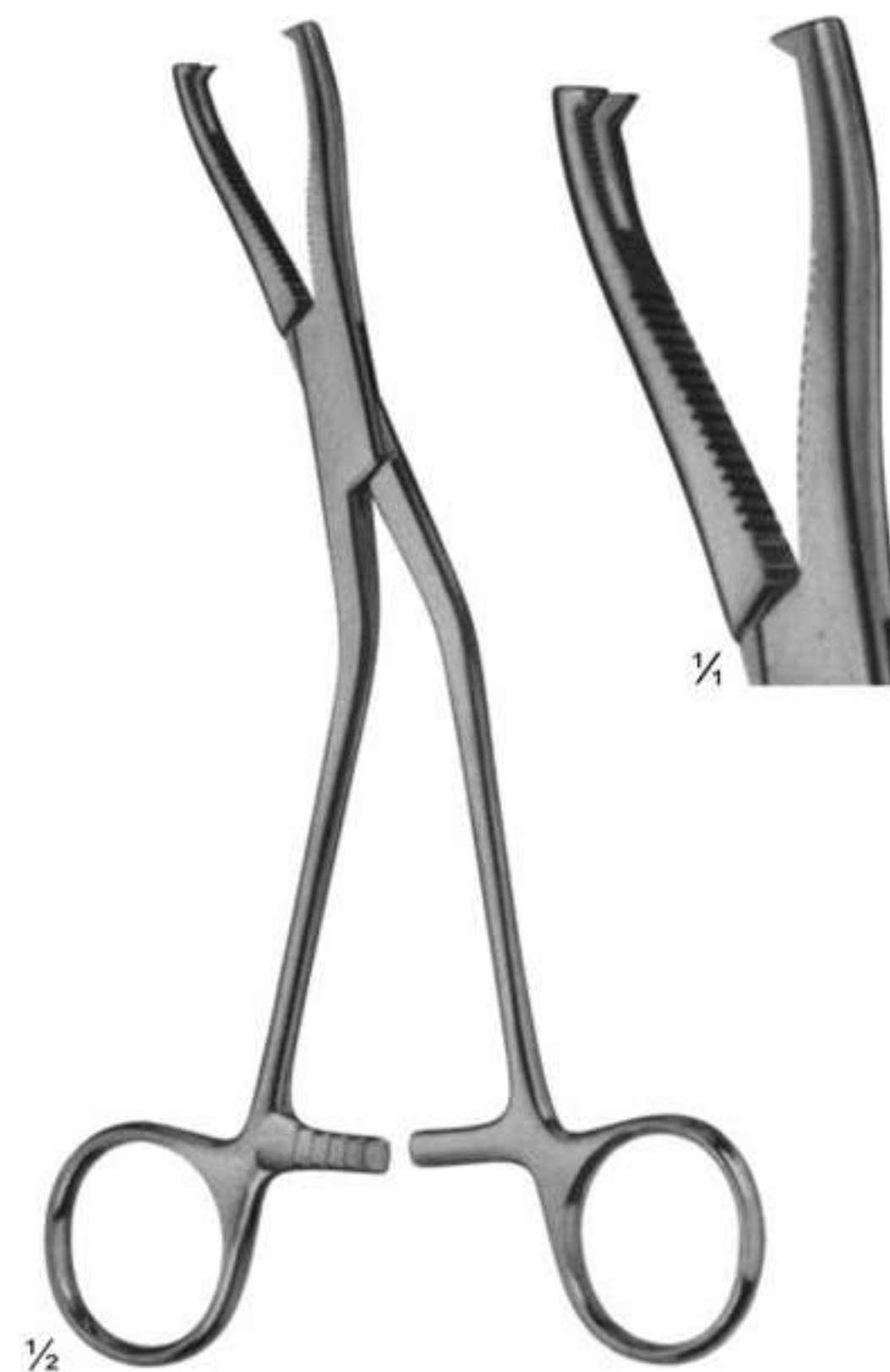

DMI-1-3205
DINGMANN 185 mm



DMI-1-3206
KERN-LANE 240 mm

**Bone Holding Forceps, Bone Rongeurs,
Bone Cutting Forceps**



DMI-1-3207
LANE 330 mm



DMI-1-3208
KERN-LANE 240 mm



DMI-1-3209
Bone Holding Forceps, Bone Rongeurs,
Bone Cutting Forceps



DMI-1-3210
LOWMAN 17-154 170 mm 17-155
205 mm



DMI-1-3211
LOWMAN-GERSTER 210 mm



DMI-1-3212
17-157 LOWMAN-HOGLUND 175 mm

**Bone Holding Forceps, Bone Rongeurs,
Bone Cutting Forceps**



DMI-1-3213
LUER150 mm



DMI-1-3214
LUER155 mm



DMI-1-3215
BLUMENTHAL155 mm



DMI-1-3216
BLUMENTHAL150 mm



DMI-1-3217
JANSEN175 mm

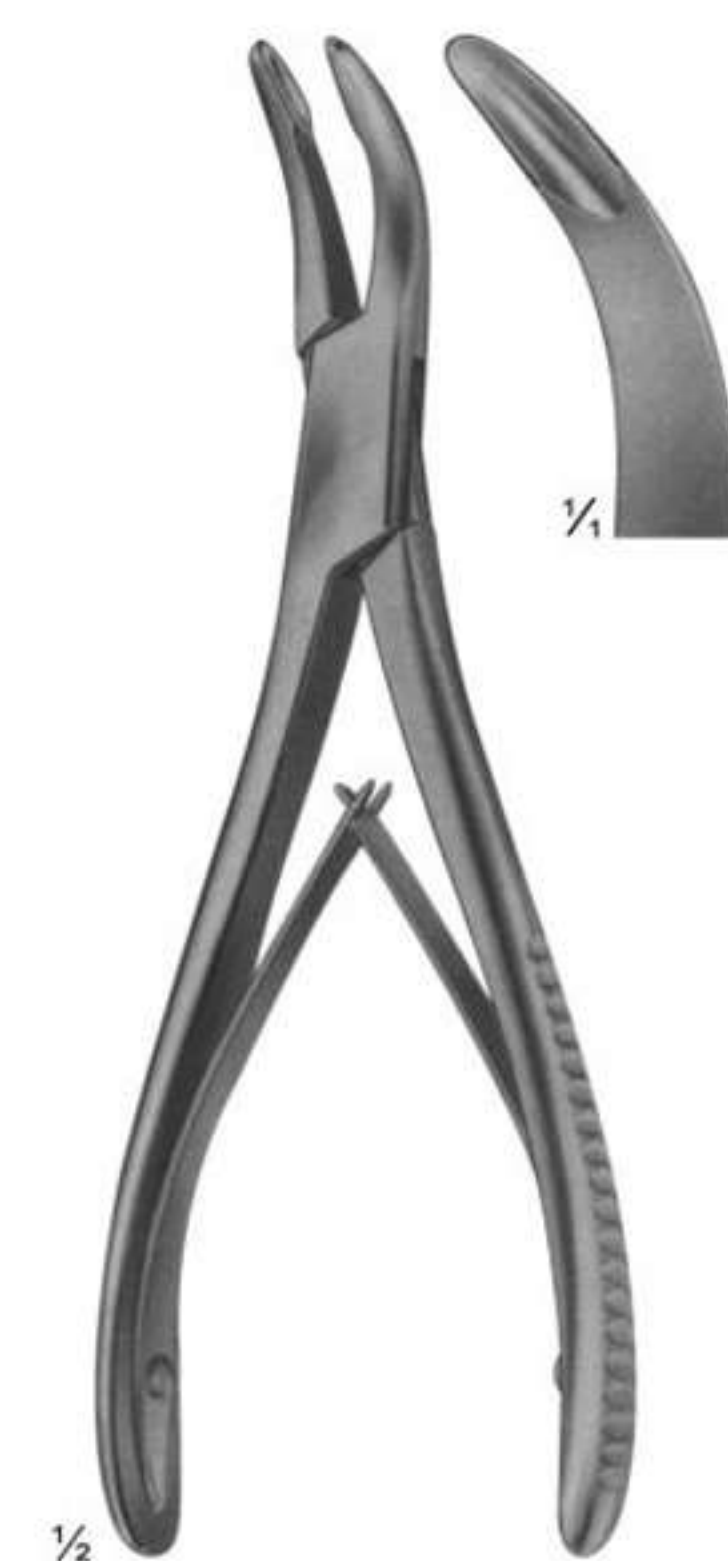

DMI-1-3218
BANE-HARTMANN175 mm

**Bone Holding Forceps, Bone Rongeurs,
Bone Cutting Forceps**



DMI-1-3219
STILLE235 mm



DMI-1-3220
LEKSELL-STILLE240mm



DMI-1-3221
STILLE-RUSKIN240mm

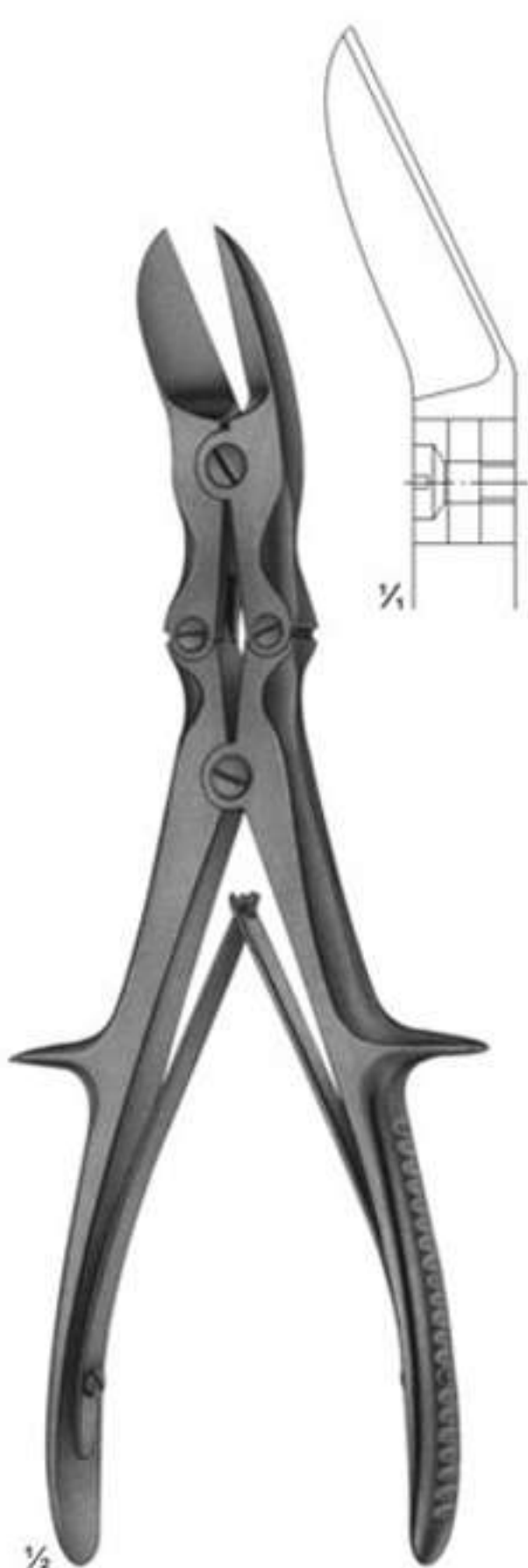

DMI-1-3222
LISTONcurved on flat240 mm



DMI-1-3223
LISTONstraight280 mm



DMI-1-3224
LISTONcurved on flat280 mm

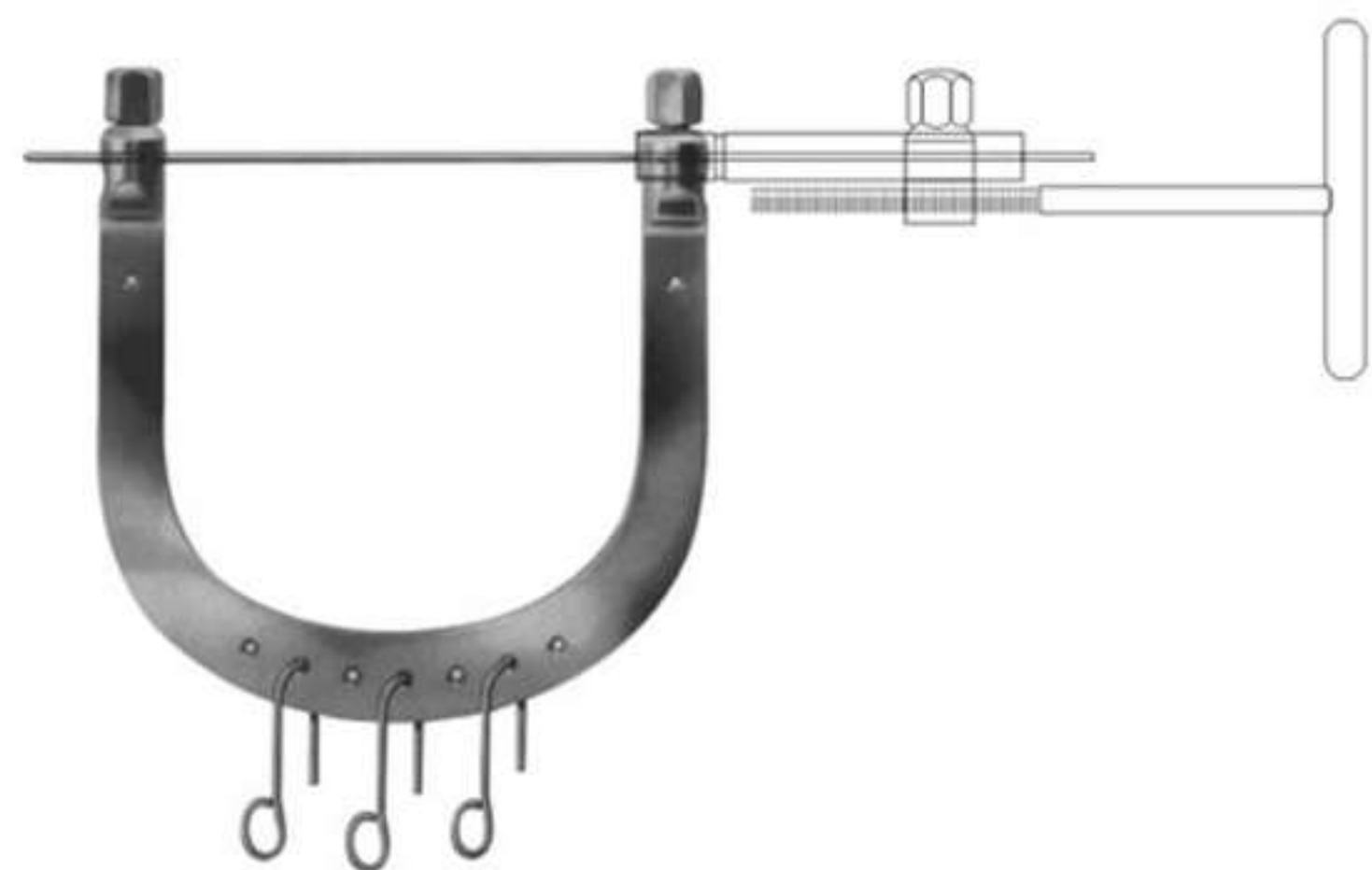

DMI-1-3301
KIRSCHNER Wire traction bows, to be used with KIRSCHNER-wires up to 2.5 mm diam., With 3 hooks, stainless steel



DMI-1-3302
Traction hook only, large size



DMI-1-3303
Traction hook only, small size



DMI-1-3304
KIRSCHNER Wire traction bows, modified, adjustable in width, holds wire securely, with 1 hook



DMI-1-3305
Fixation clamp, to secure clamping jaws of 17-179 stainless steel

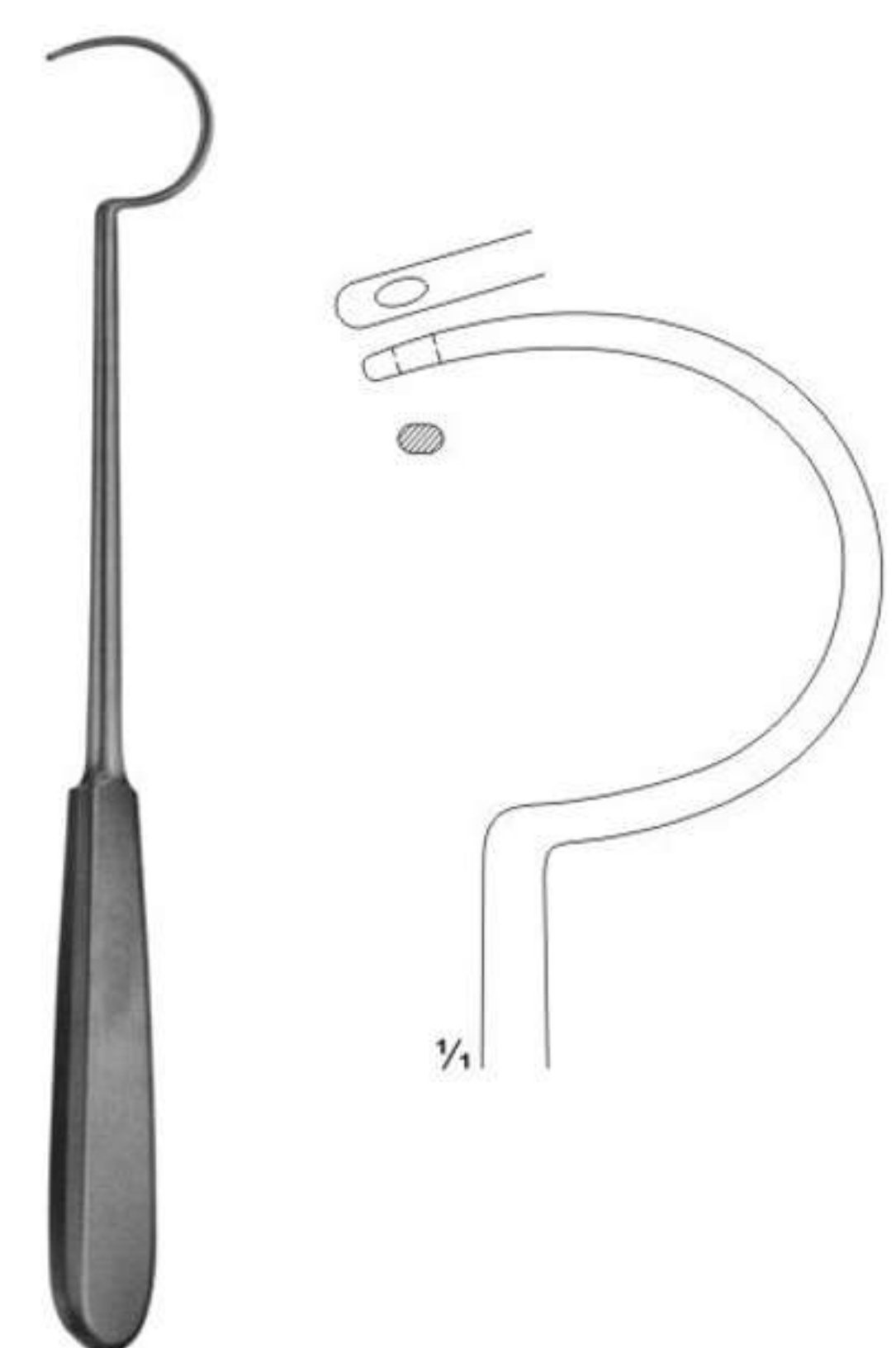

DMI-1-3306
DEMEL Wire guides 17-186275 mm 17-187285 mm 17-188305 mm

Plaster Instruments

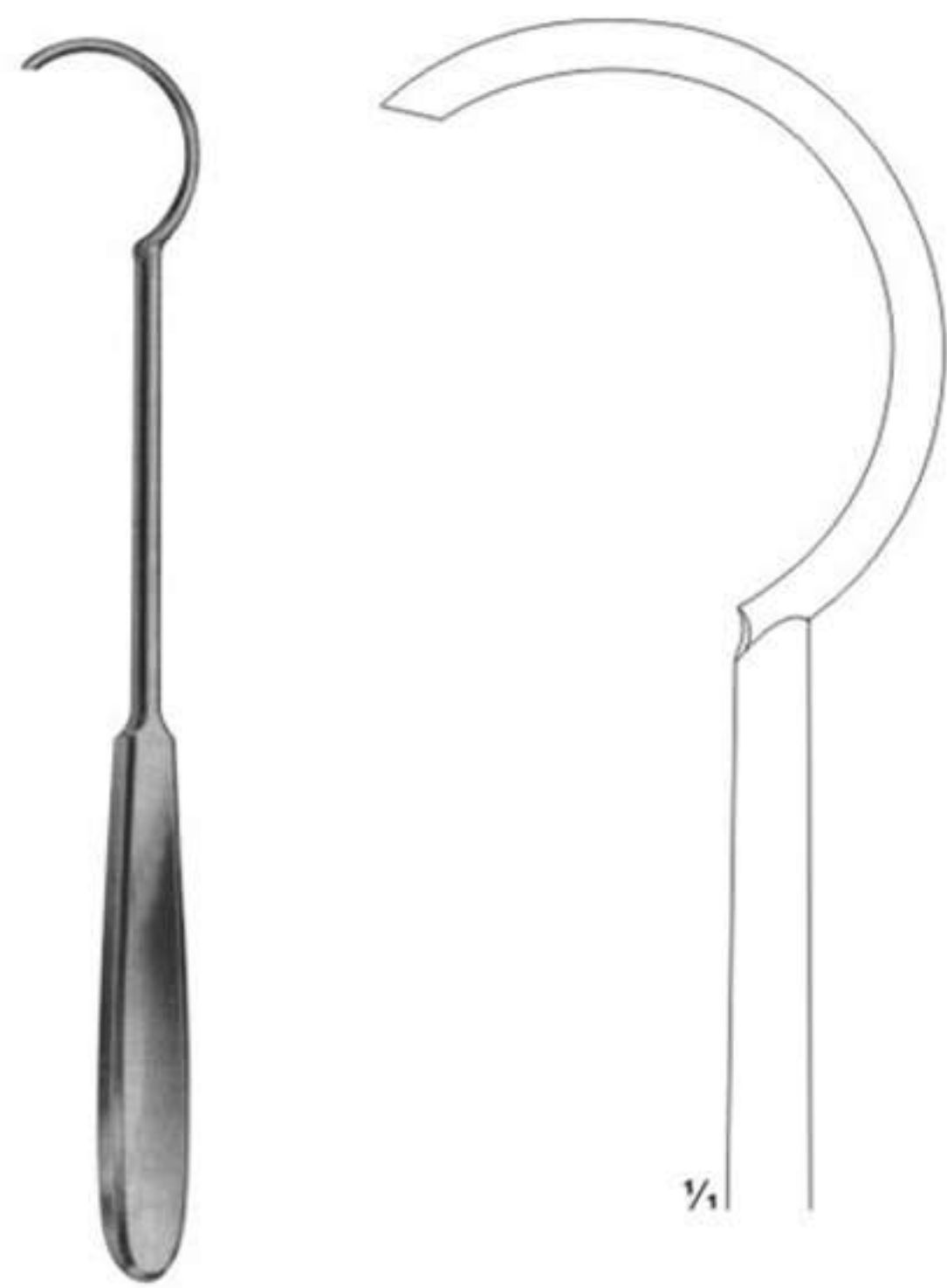

DMI-1-3307
17-189240 mm

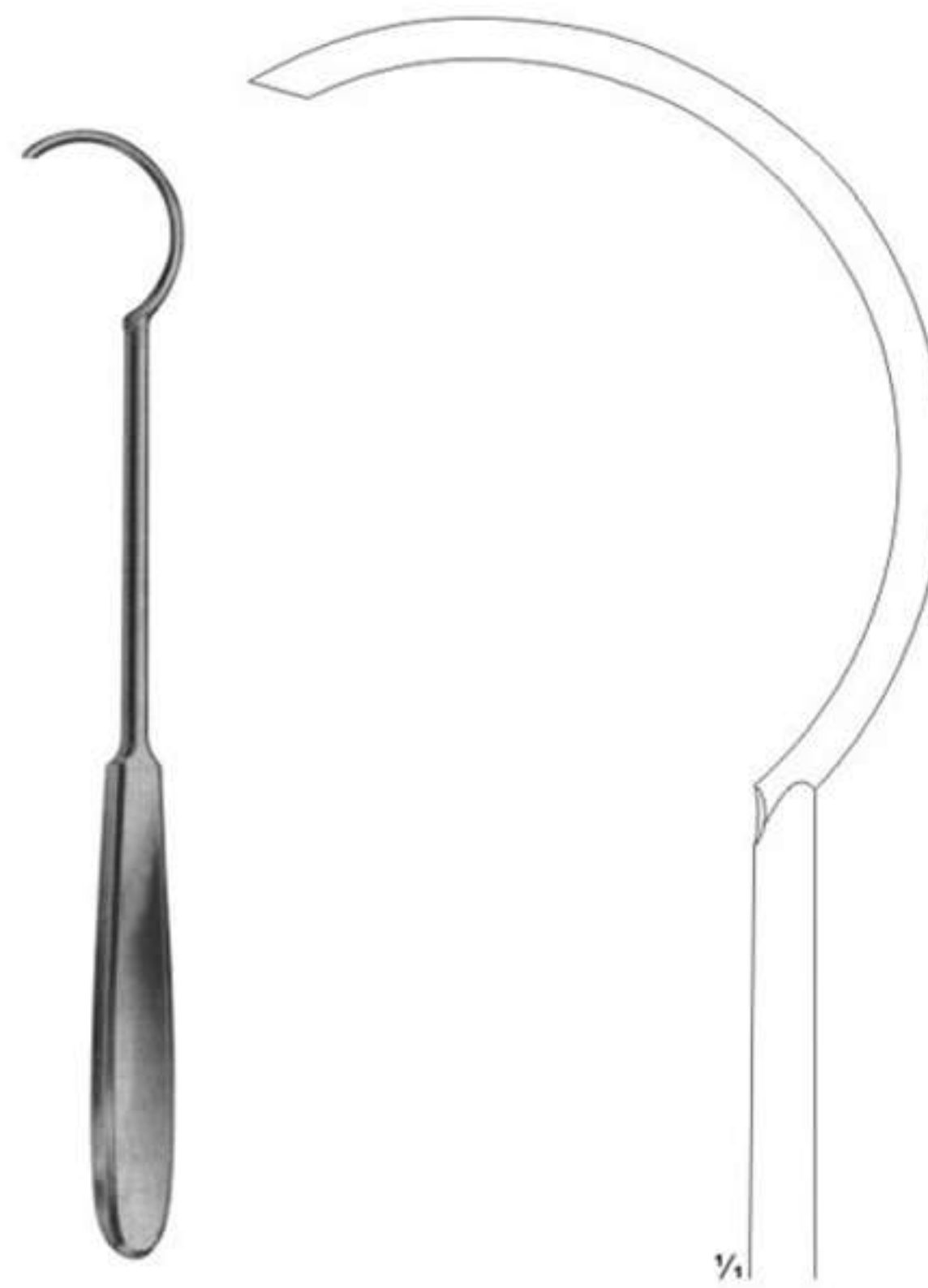

DMI-1-3308
17-190270 mm

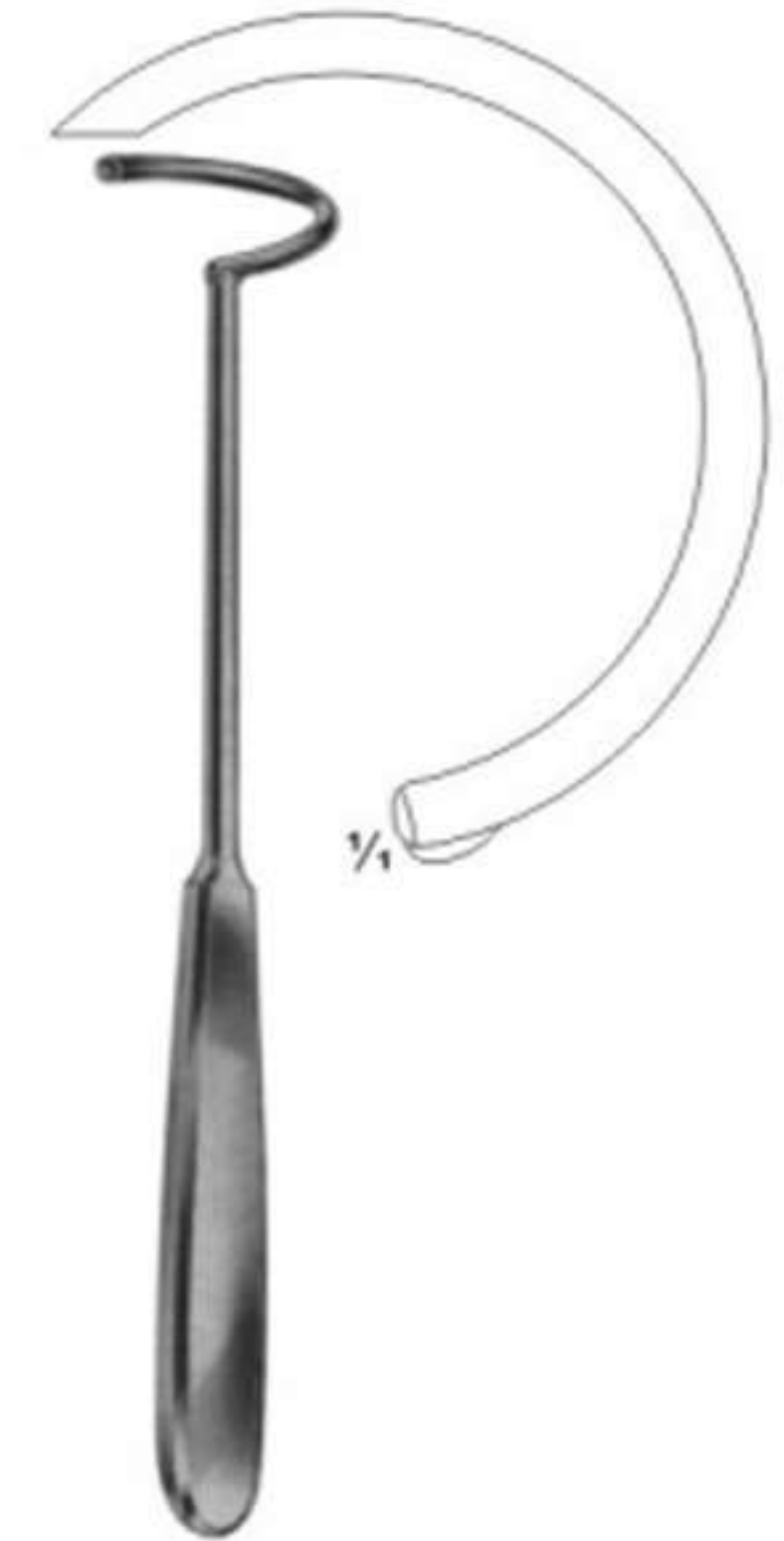

DMI-1-3309
17-191225 mm



DMI-1-3310
DUROGRIP Holding forceps for cerclagewire, with lateral jaws to avoid wire slipping off 170 mm



DMI-1-3311
DUROGRIP Wire, tightening pliers, Ligature pliers 150 mm



DMI-1-3312
DUROGRIP Wire, tightening pliers, Ligature pliers 150 mm



DMI-1-3313
with serrated jaws 140 mm



DMI-1-3314
one jaw smooth, one jaw
serrated 140 mm



DMI-1-3315
with serrated jaws 17-198 with
longitudinal and transversal grooves 170 mm



DMI-1-3316
190 mm



DMI-1-3317
Extraction pliers for boring wires



DMI-1-3318
Flat-nosed pliers, parallel 185 mm



DMI-1-3319
Vise grip 200 mm

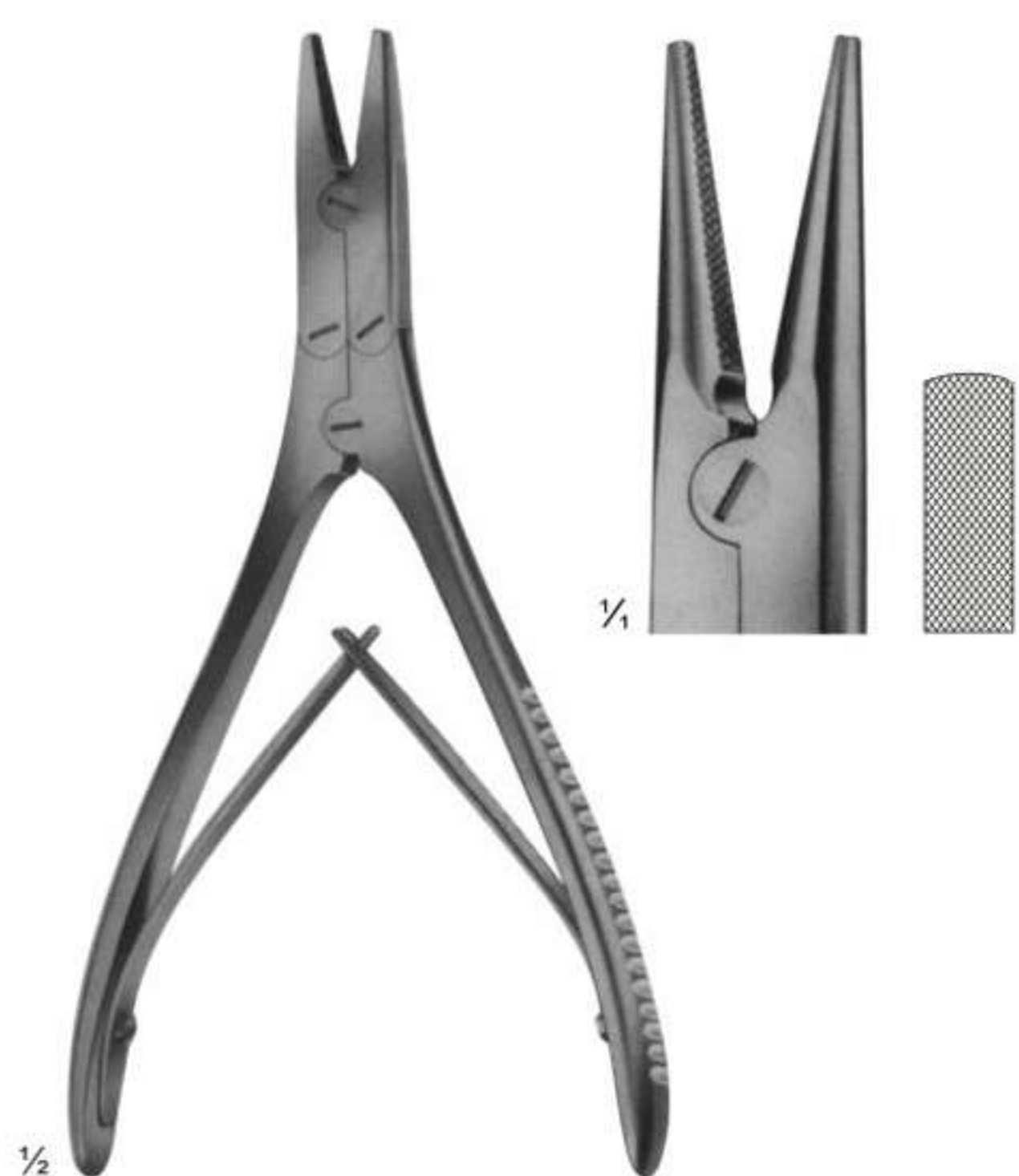

DMI-1-3320
Round Pliers 180mm



DMI-1-3321
Bending pliers for wires up to 1.8 mm diam

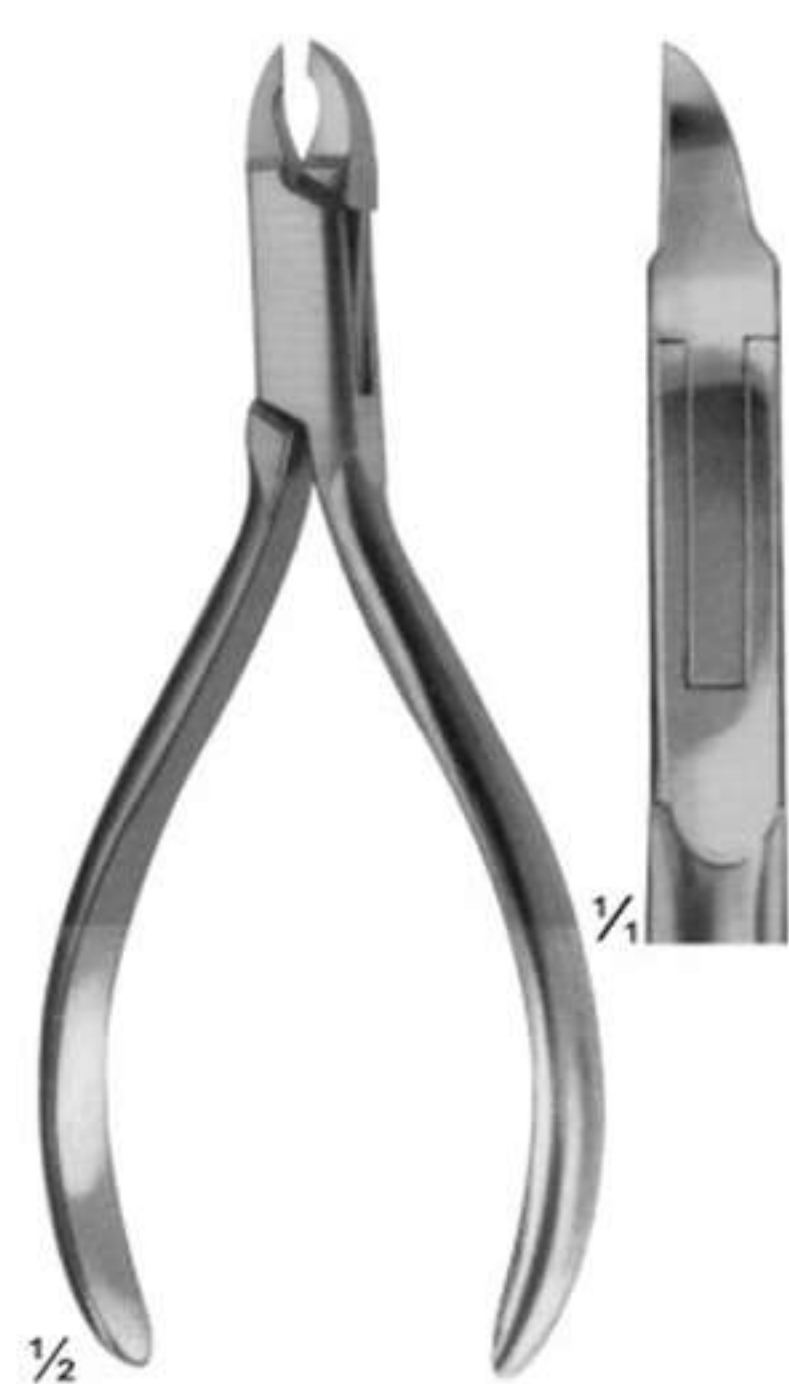

DMI-1-3322
ANGLE DUROTIP 130 mm

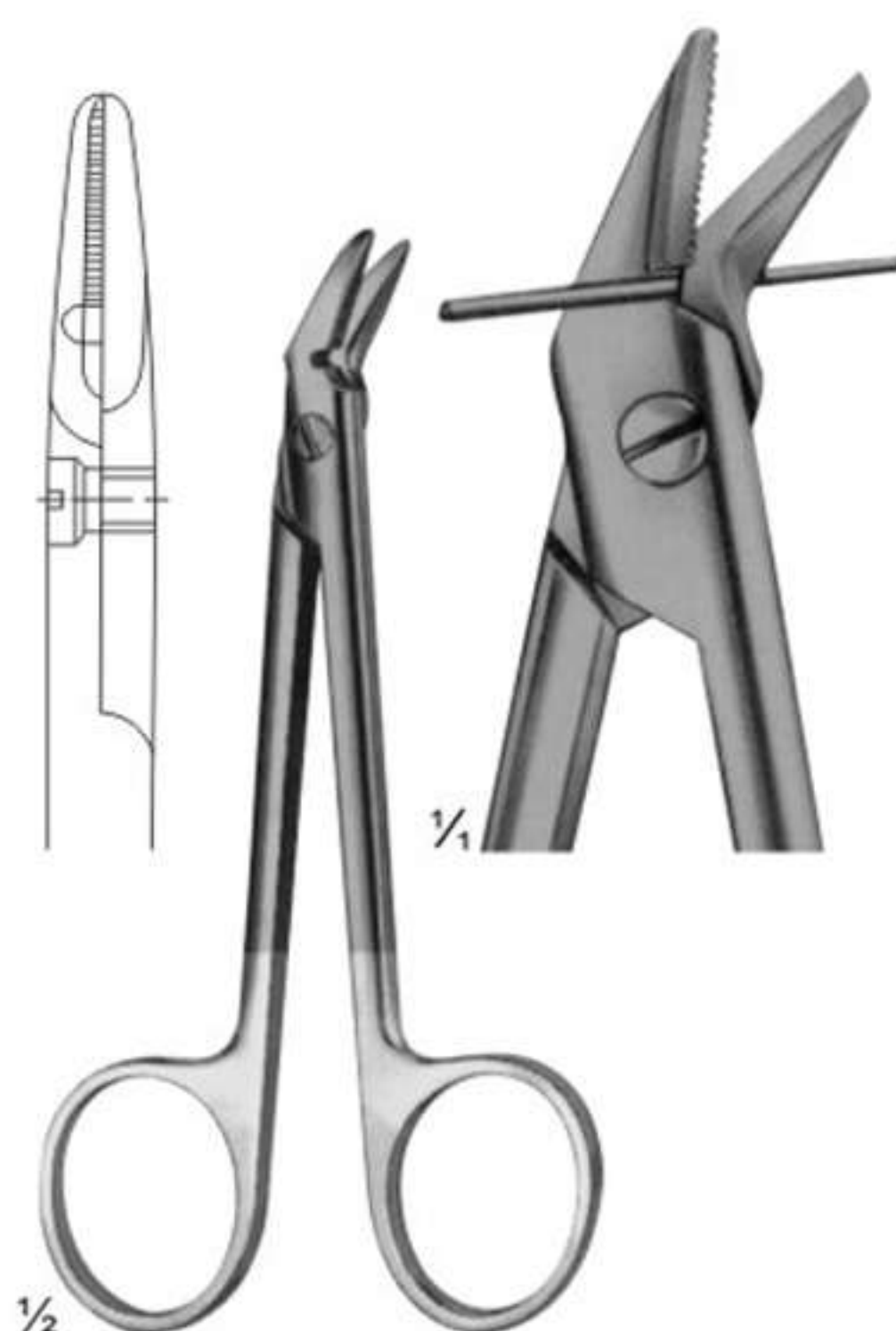

DMI-1-3323
DUROTIP ANGEL

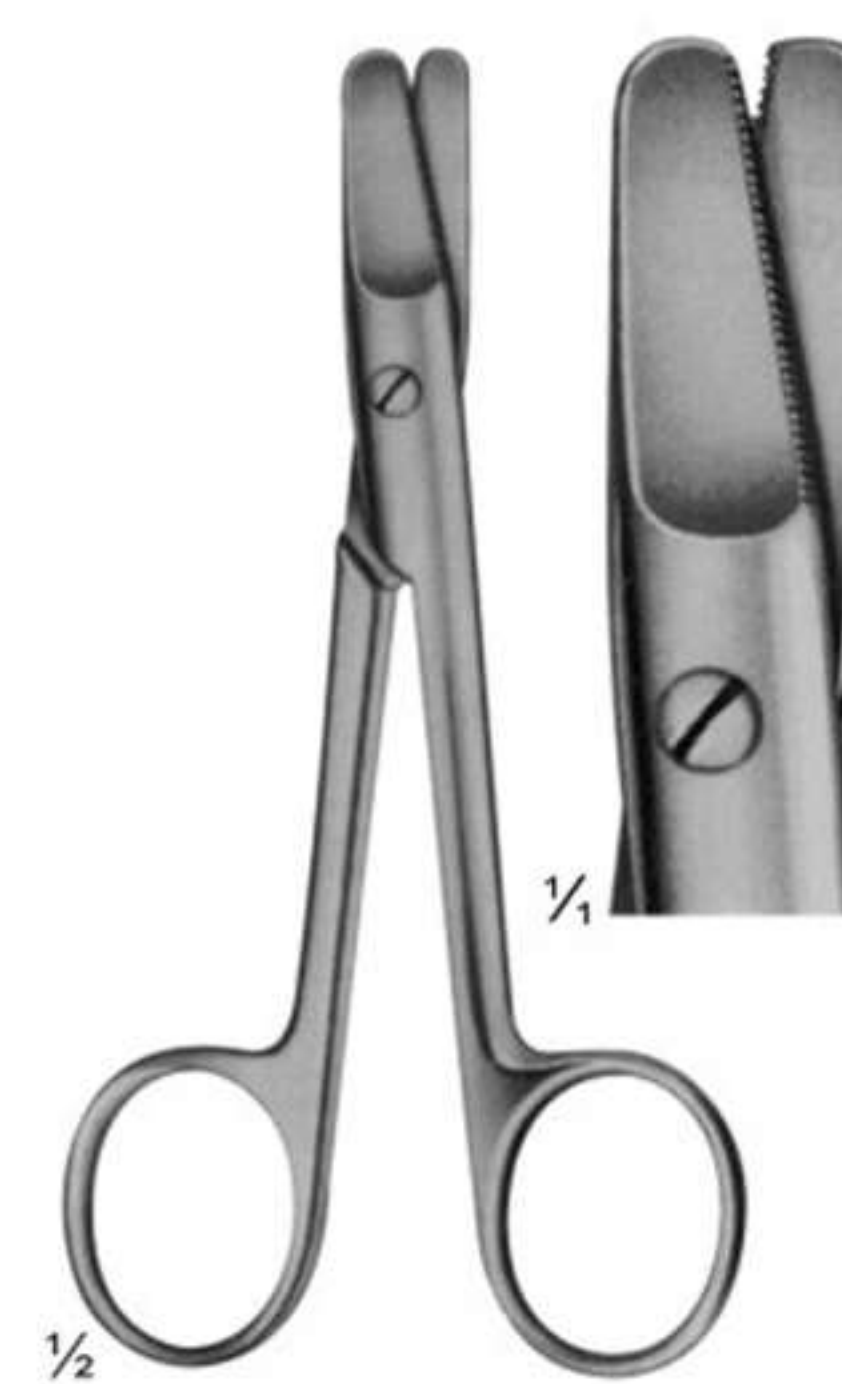

DMI-1-3324
120 mm



DMI-1-3325
240 mm



DMI-1-3326
145 mm



DMI-1-3327
145 mm



DMI-1-3328
220 mm



DMI-1-3329
320 mm



DMI-1-3330
Cutter for cutting off KIRSCHNER wires,
Tibia head screws, bolts, pins, up to
6 mm diam. 470 mm

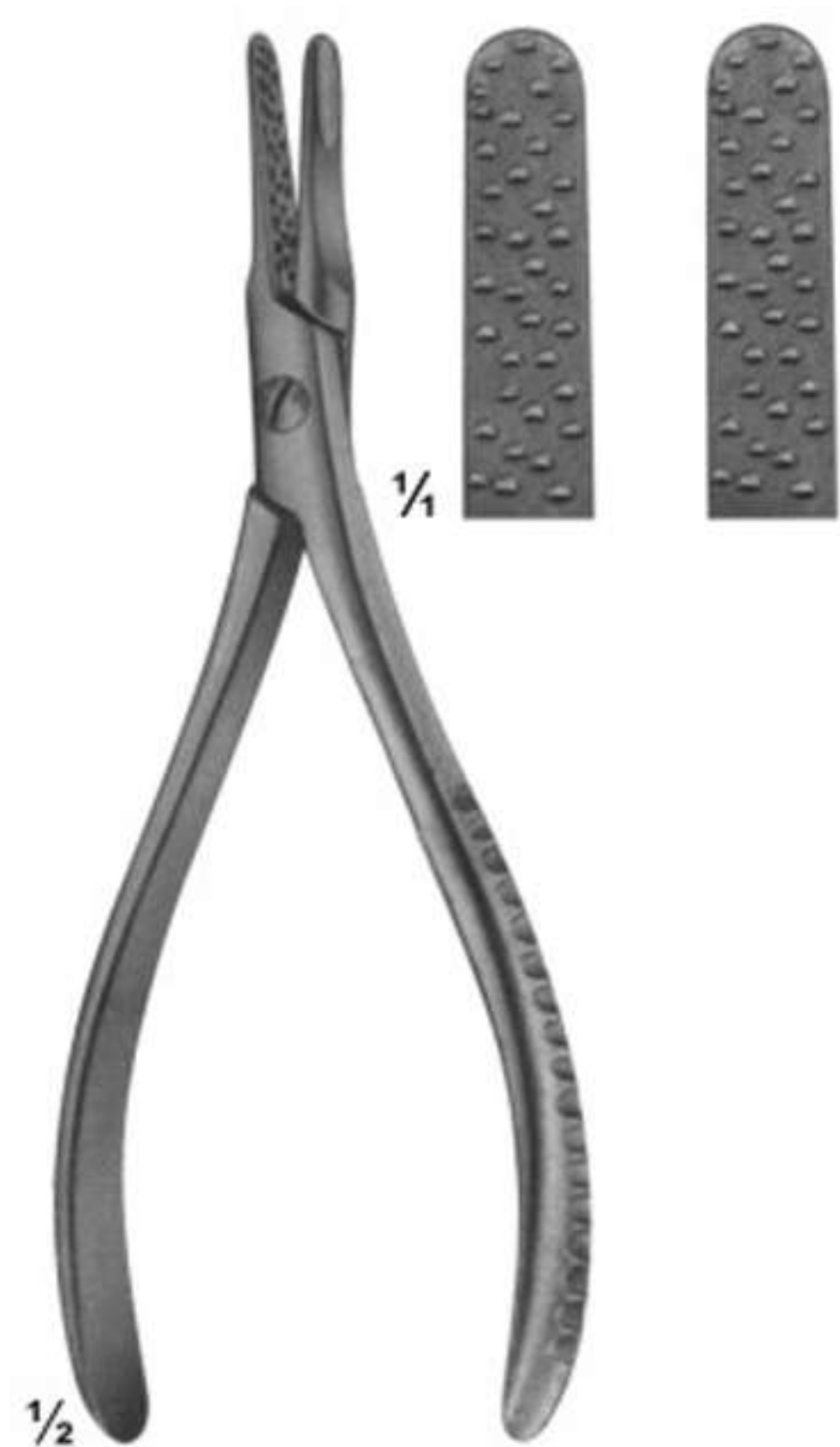

DMI-1-3331
Nail extracting forceps 135 mm



DMI-1-3332
Nail extracting forceps 145 mm

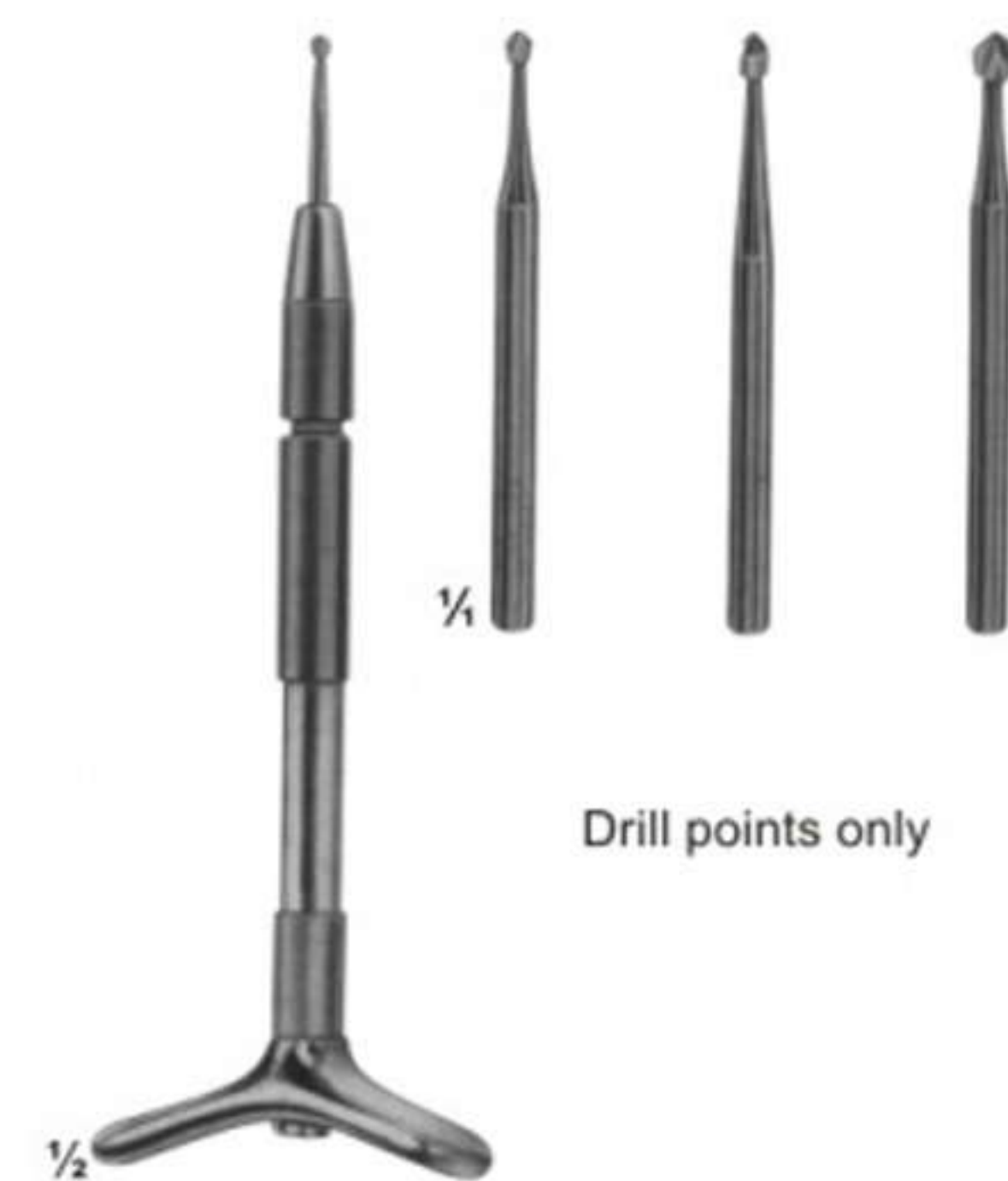

DMI-1-3333
Finger nail drill with 3 drill points

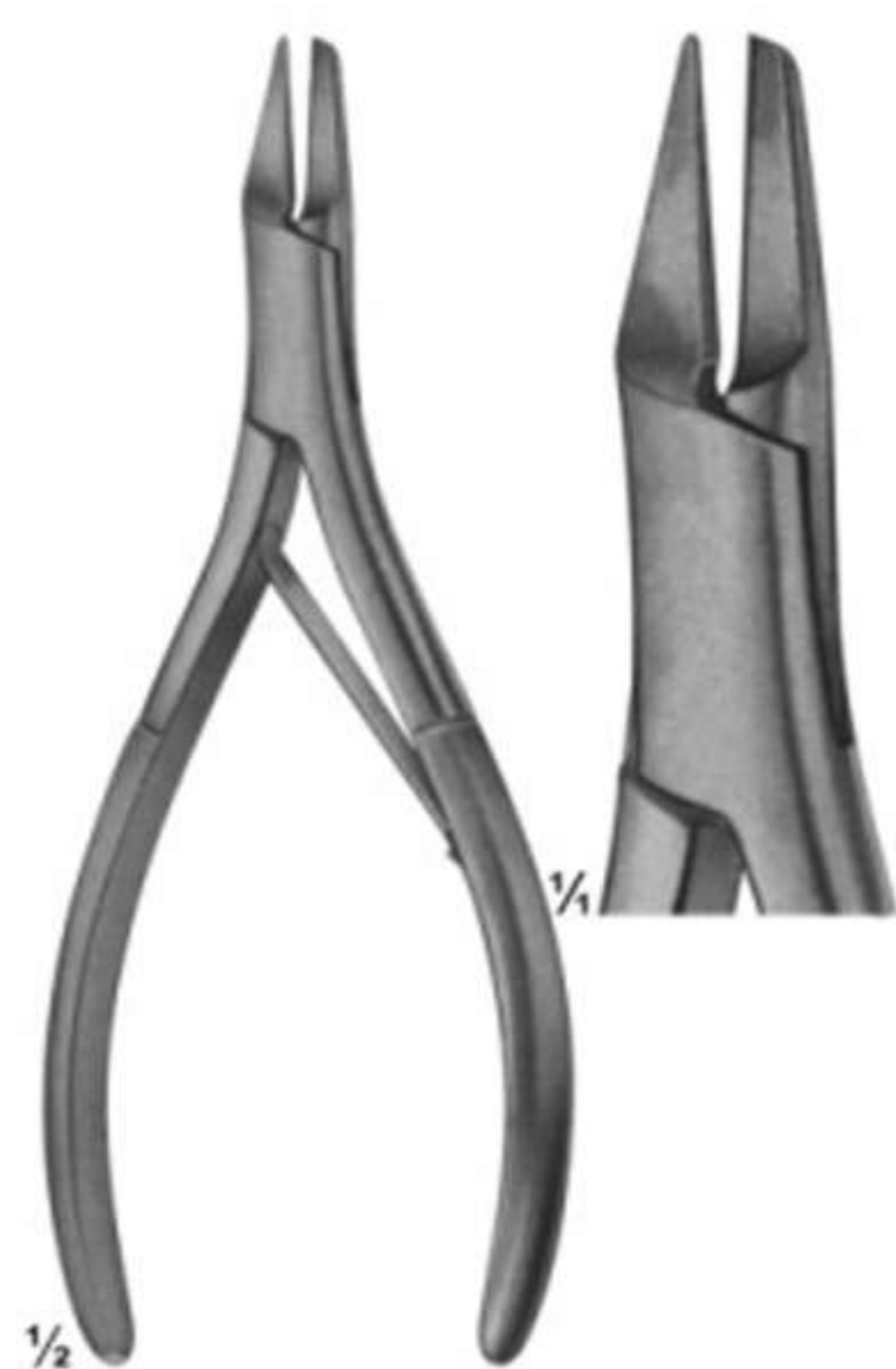

DMI-1-3334
220 mm

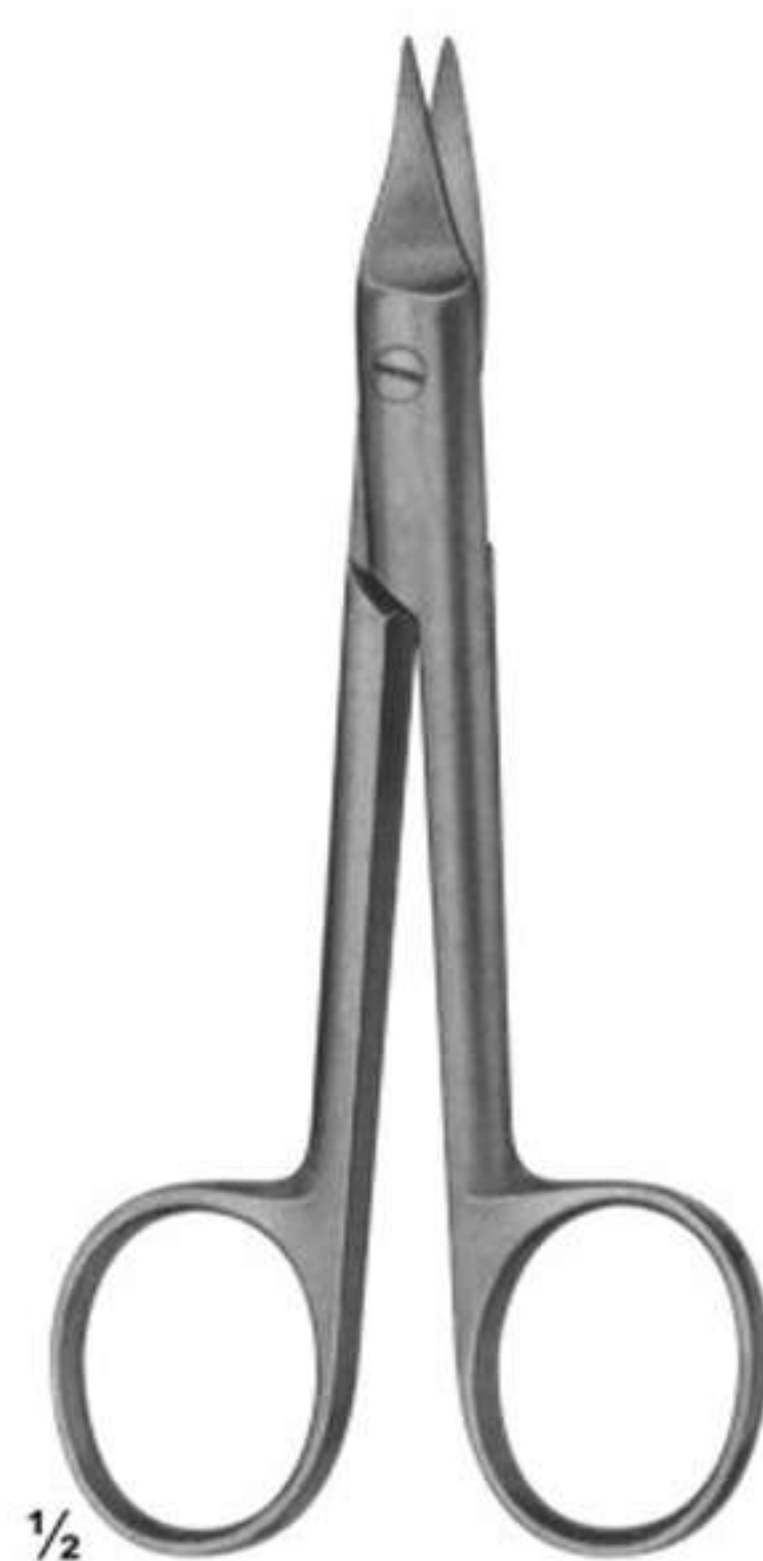

DMI-1-3335
SYSTRUNK Scissors, for splitting finger nails 130 mm



DMI-1-3336
Finger ring saw 150 mm

Plaster Instruments



DMI-1-3337
Spare blade



DMI-1-3338
STILLE-AESFULAP260 mm



DMI-1-3339
STILLE-AESFULAP360 mm



DMI-1-3340
HENING270 mm



DMI-1-3341
MOD.USA230 mm



DMI-1-3342
290 mm



DMI-1-3343
290 mm

Suction Instruments



DMI-1-3401
For tonsillectomy, oral- and laryngeal operations 180 mm



DMI-1-3402
Suction cannula for tonsillectomy, oral- and laryngeal operations 220 mm



DMI-1-3403
Suction cannula for tonsillectomy, oral- and laryngeal operations 180 mm



DMI-1-3404
S-shaped blunt cannula for aspirating fluid from the excretory ducts of large glands and for keeping the operating area clear 170 mm

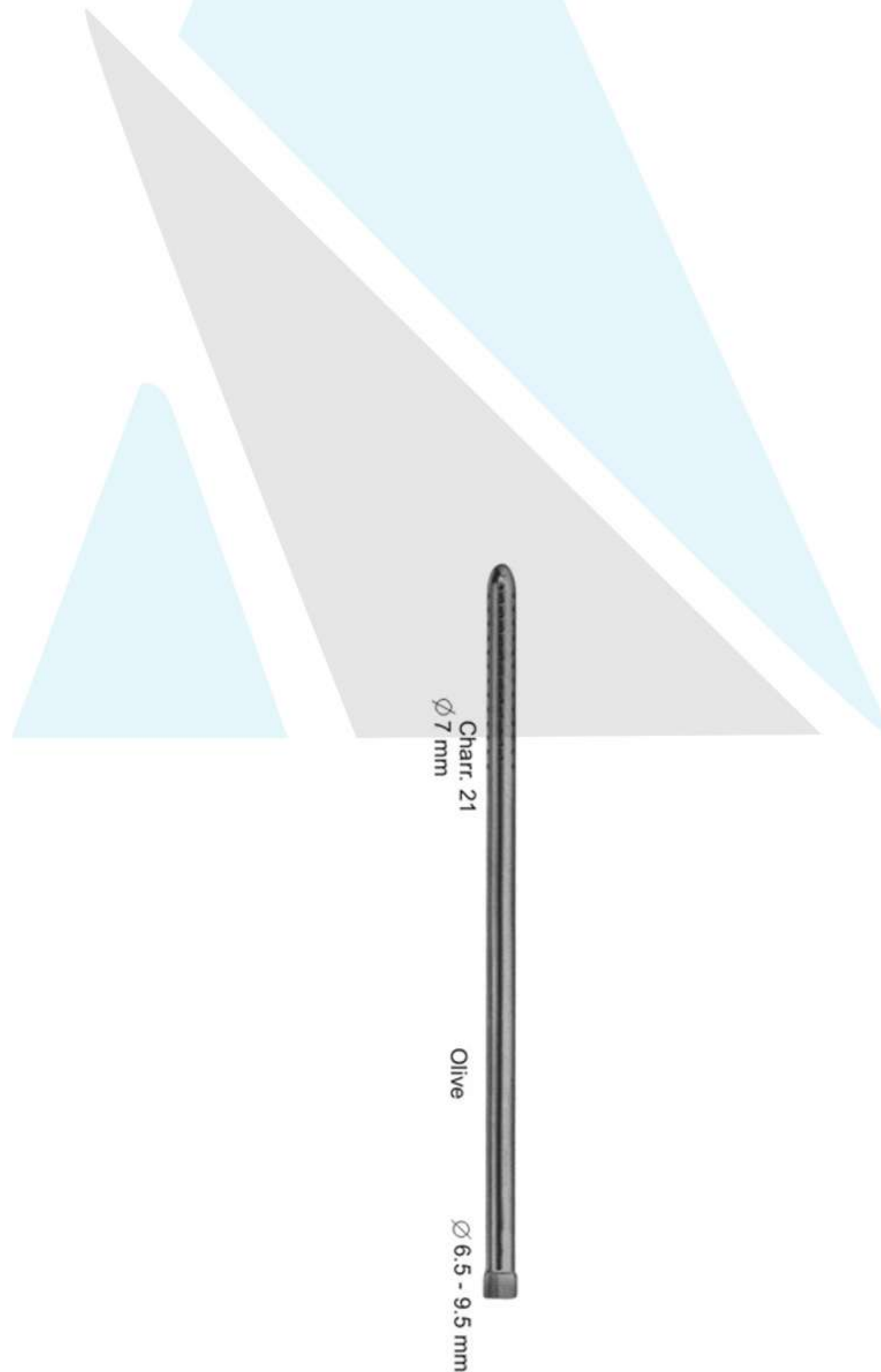

DMI-1-3405
POOL Suction cannula, with outer tube to be screwed off 225 mm



DMI-1-3406
POOL Suction cannula, with outer tube to be screwed off 225 mm

Suction Instruments



DMI-1-3401
For tonsillectomy, oral and laryngeal operations 180 mm



DMI-1-3402
Suction cannula for tonsillectomy, oral and laryngeal operations 220 mm



DMI-1-3403
Suction cannula for tonsillectomy, oral and laryngeal operations 180 mm



DMI-1-3404
S-shaped blunt cannula for aspirating fluid from the excretory ducts of large glands and for keeping the operating area clear 170 mm



DMI-1-3405
POOL suction cannula, with outer tube to be screwed of 225 mm



DMI-1-3406
POOL suction cannula, with outer tube to be screwed off 225 mm

Suction Instruments

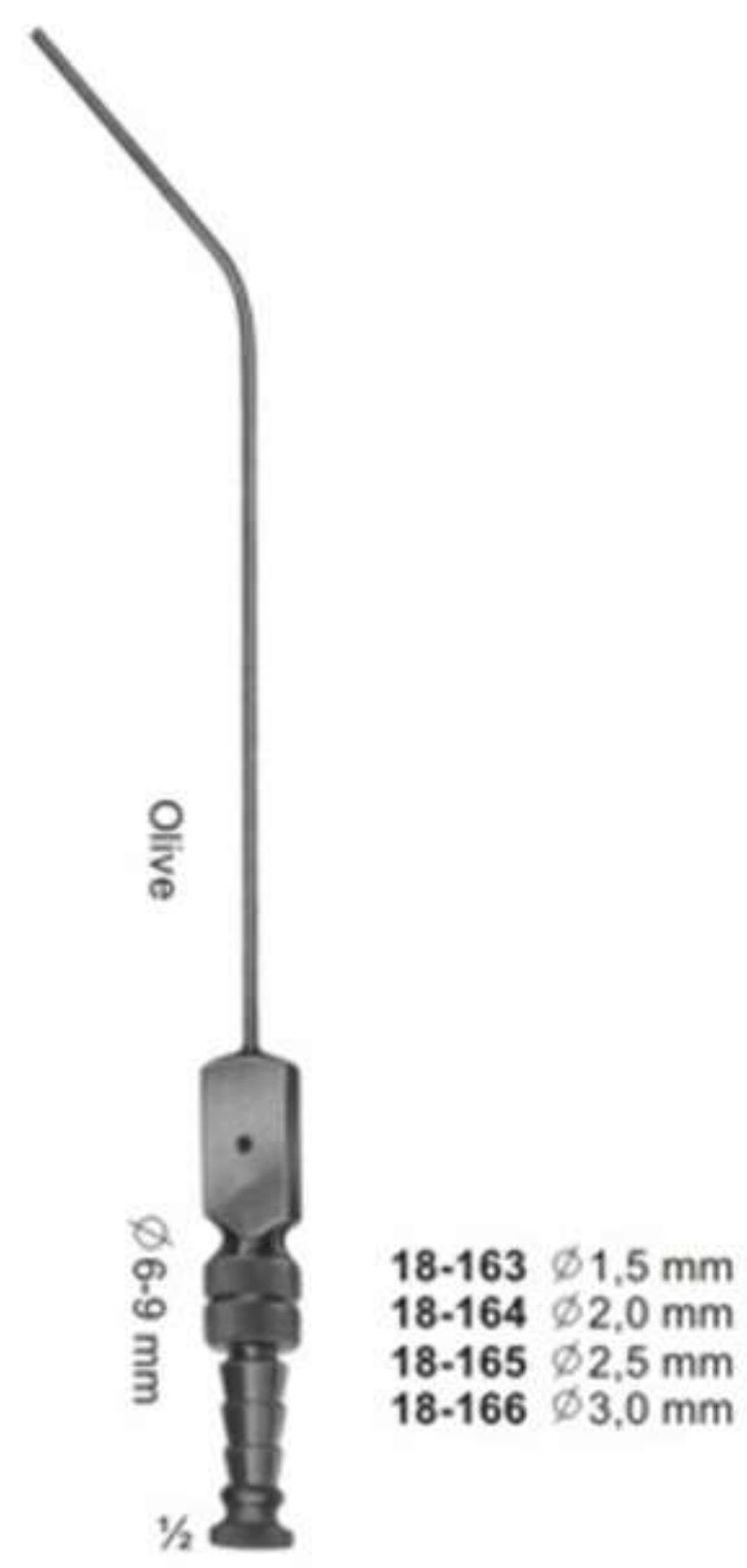

- 18-163 Ø 1,5 mm
- 18-164 Ø 2,0 mm
- 18-165 Ø 2,5 mm
- 18-166 Ø 3,0 mm

DMI-1-3407
 PLESTER with finger cut-off and stylet, thumb piece parallel to curve, with LUER hub 195 mm

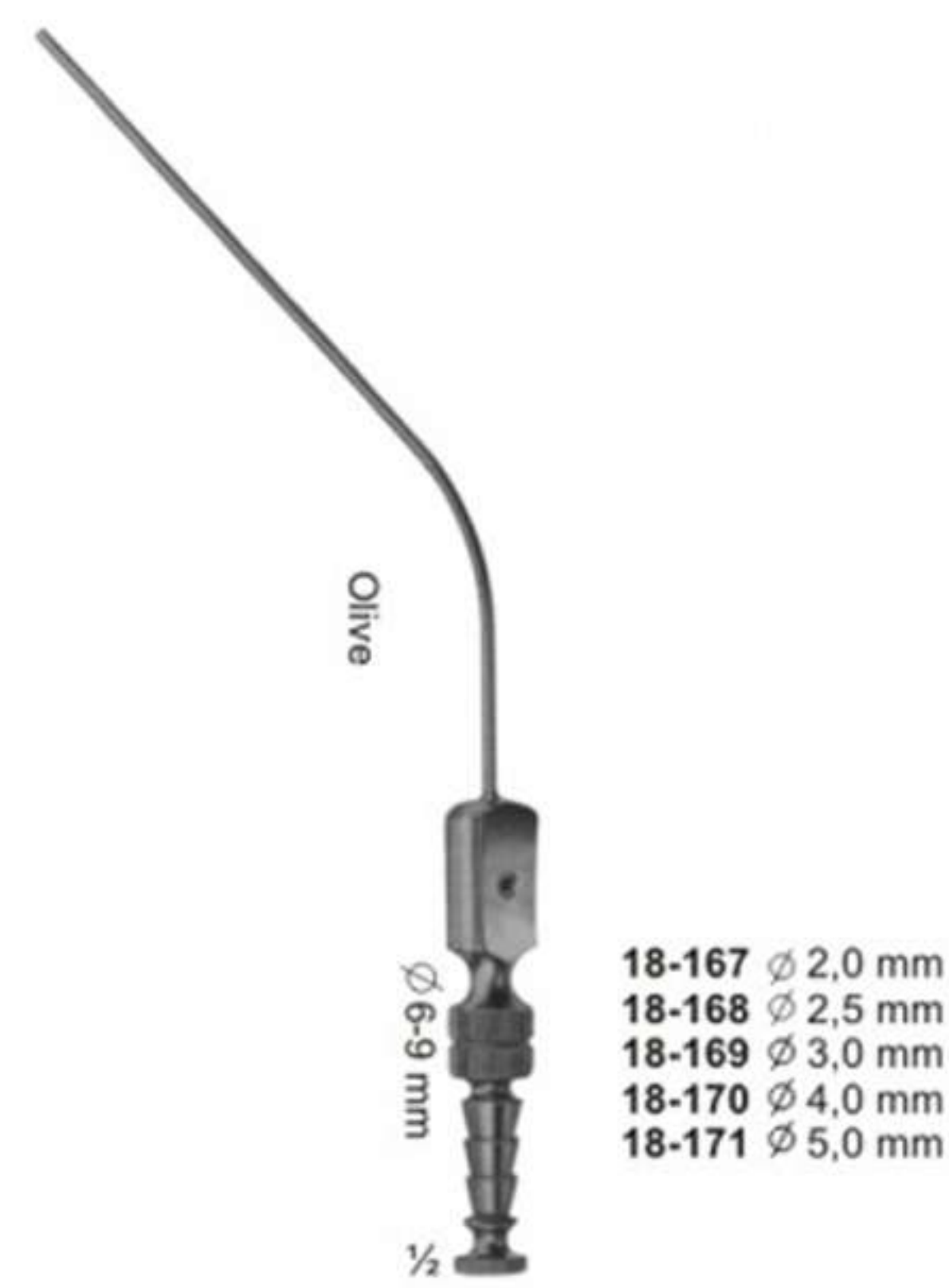

- 18-167 Ø 2,0 mm
- 18-168 Ø 2,5 mm
- 18-169 Ø 3,0 mm
- 18-170 Ø 4,0 mm
- 18-171 Ø 5,0 mm

DMI-1-3408
 FERGUSSON with finger cut-off and stylet, thumb piece 90 to curve, with LUER hub 180 mm



DMI-1-3409
 FERGUSSON with finger cut-off and stylet, thumb piece 90 to curve, with LUER hub 180 mm



DMI-1-3410
 FRAZIER insulated, with finger cut-off and stylet, thumb piece 90 to curve, with LUER hub 180 mm

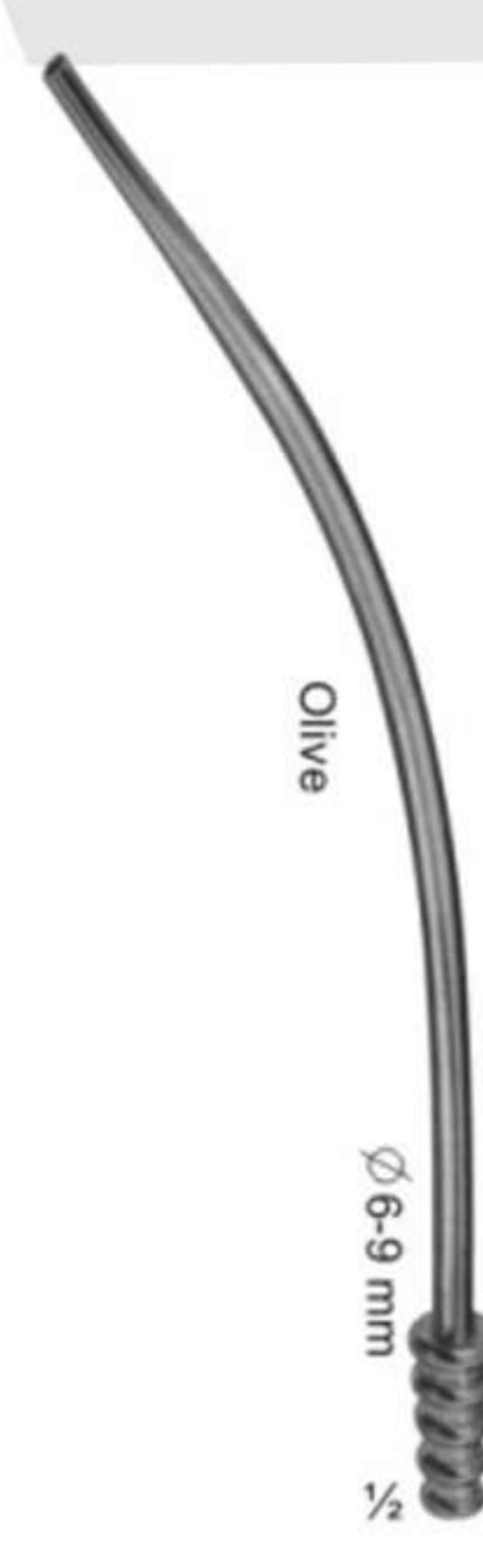

DMI-1-3411
 LUER 5,0 mm diam., Tip 6,5 mm wide, Nasal suction tube, with LUER hub 180 mm



DMI-1-3412
 Nasal suction tubes 175 mm

Suction Instruments



DMI-1-3413
GORNEY Suction dissector 180 mm



DMI-1-3414
Suction raspatories, sharp, bayonet-shaped, with stylet 200 mm



DMI-1-3415
LOPEZ-REINKETonsil dissector with suction device 235 mm

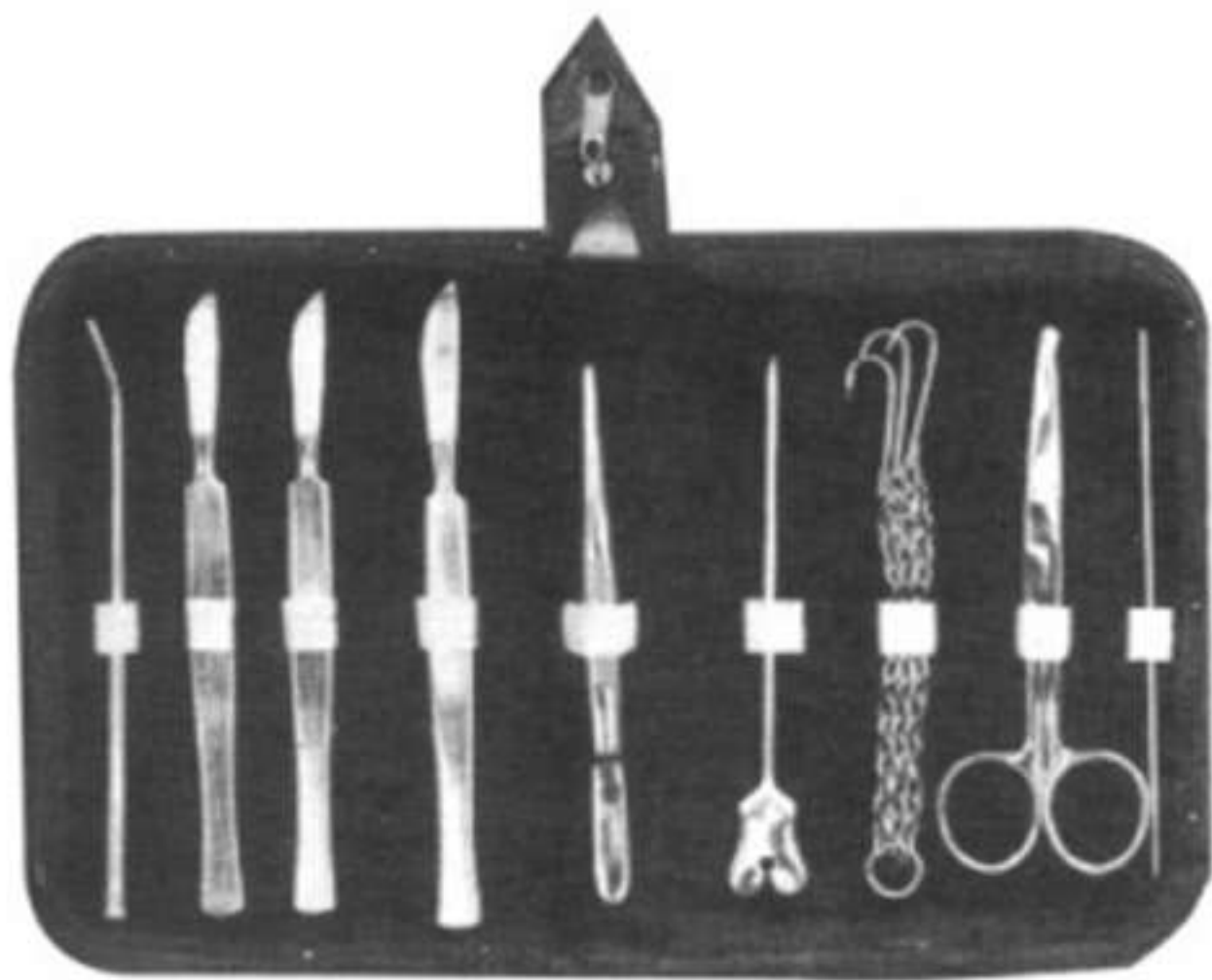

DMI-1-3416

1- Blow pipe .2- 3 PCS .scalpel.3- Dissecting forcep 13 cm.4- Grooved director with tounge tie 13 cm.5- Triple chain hook.6- Dressing scissors probe pointed 13 cm.7- Probe double 13 cm.8- Zipper case inside red velvet.

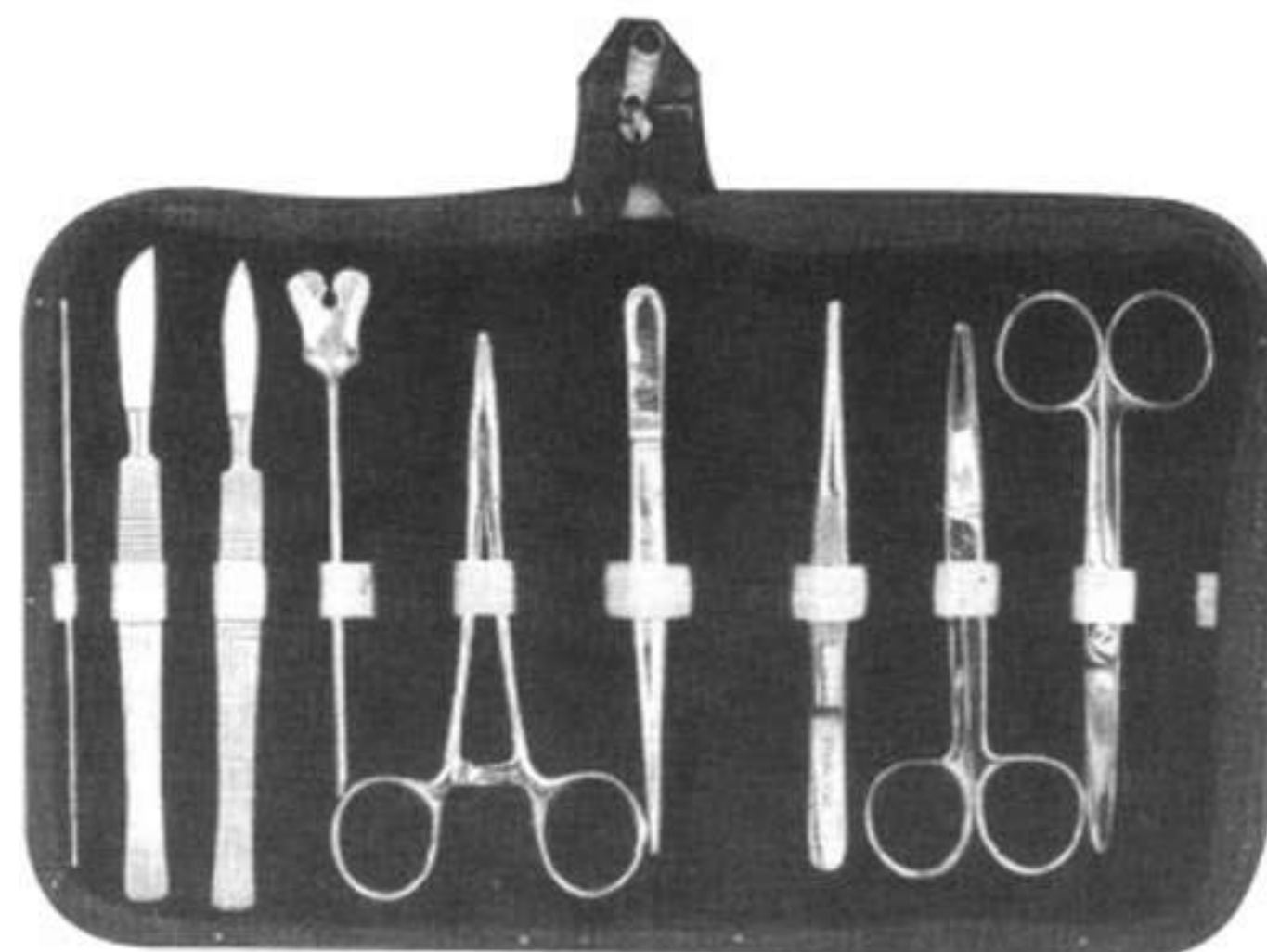

DMI-1-3417

1- Probe Double 13 cm2- 2 PCS. Scalpel S.3- Grooved Director With tongue Tie 13 cm 4- Mayo Hegar Needle Holder 13cm5- Disscting Forcep 13 cm 1x2 Teeth6- Dressing Forcep 13 CMS Serrated.7- Dressing Scissor 13 cm S/B STR.8- Dressing Scissor 13 cm S/B CVD.9- Zipper Case Inside Red Velvet.

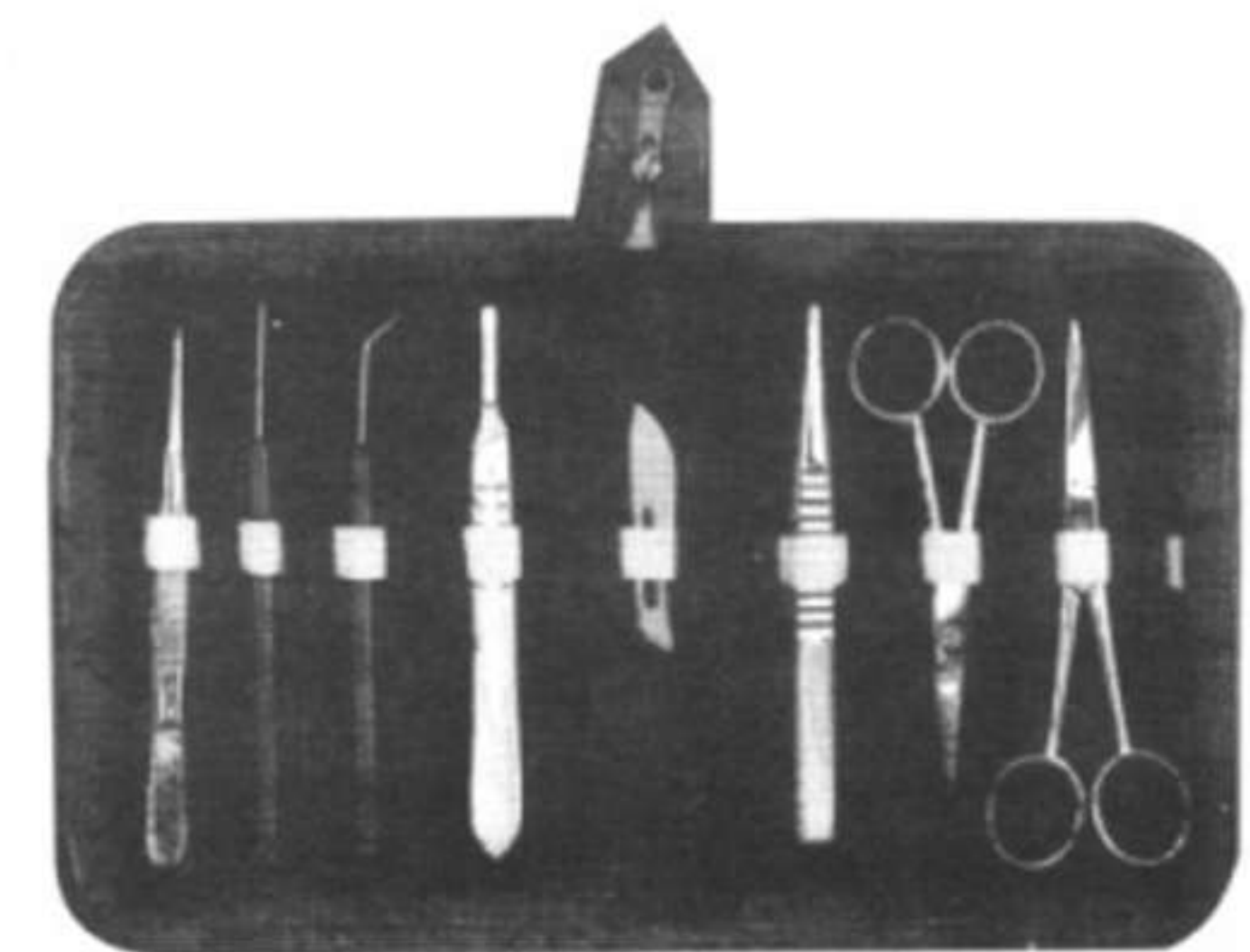

DMI-1-3418

1- Dissecting Forcep 11.5 cm Sharp Point.2- Iris Scissor3- B.P Handle No. 44- Teasing Needle Sharp angular.5- Blade No. 226- Thumb Forceps T.O.E 13 cm7- Dissecting Scissor STR 11.5 cm8- Dissecting Scissor STR 13 cm9- Zipper case Inside Red Velvet

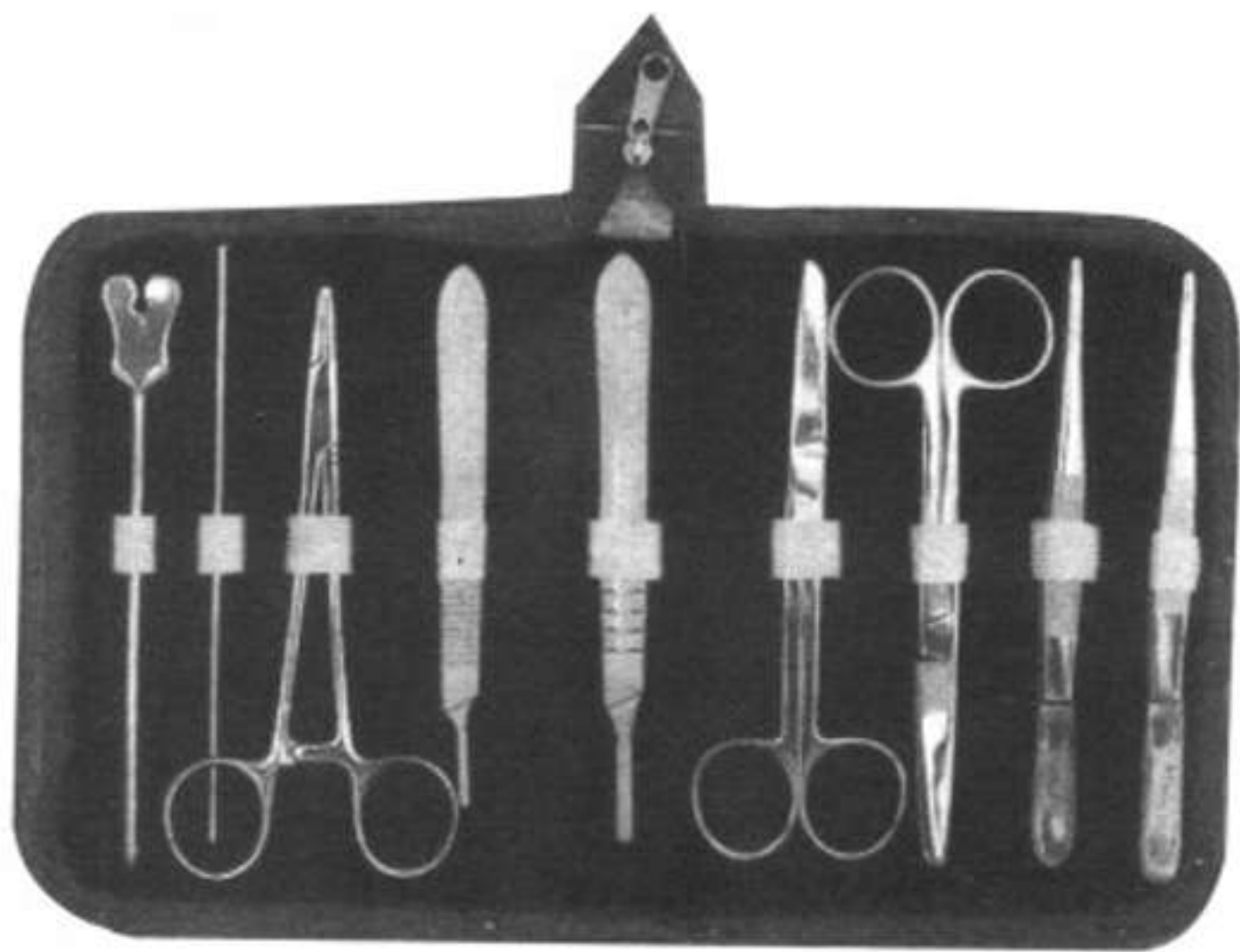

DMI-1-3419

- 1- Grooved Director with Tongue Tie 14 cm
- 2- Probe Double 14 cm
- 3- Mayo Hegar Needle Holder 14 cm
- 4- BP. Handle no. 35
- 5- BP. Handle no. 46
- 6- Dressing Scissor 14 cm S/B STR
- 7- Dressing Scissor 14 cm S/B CVD
- 8- Dressing Forcep 1x2 Teeth 14 cm
- 9- Dressing Forcep Serrated 14 cm

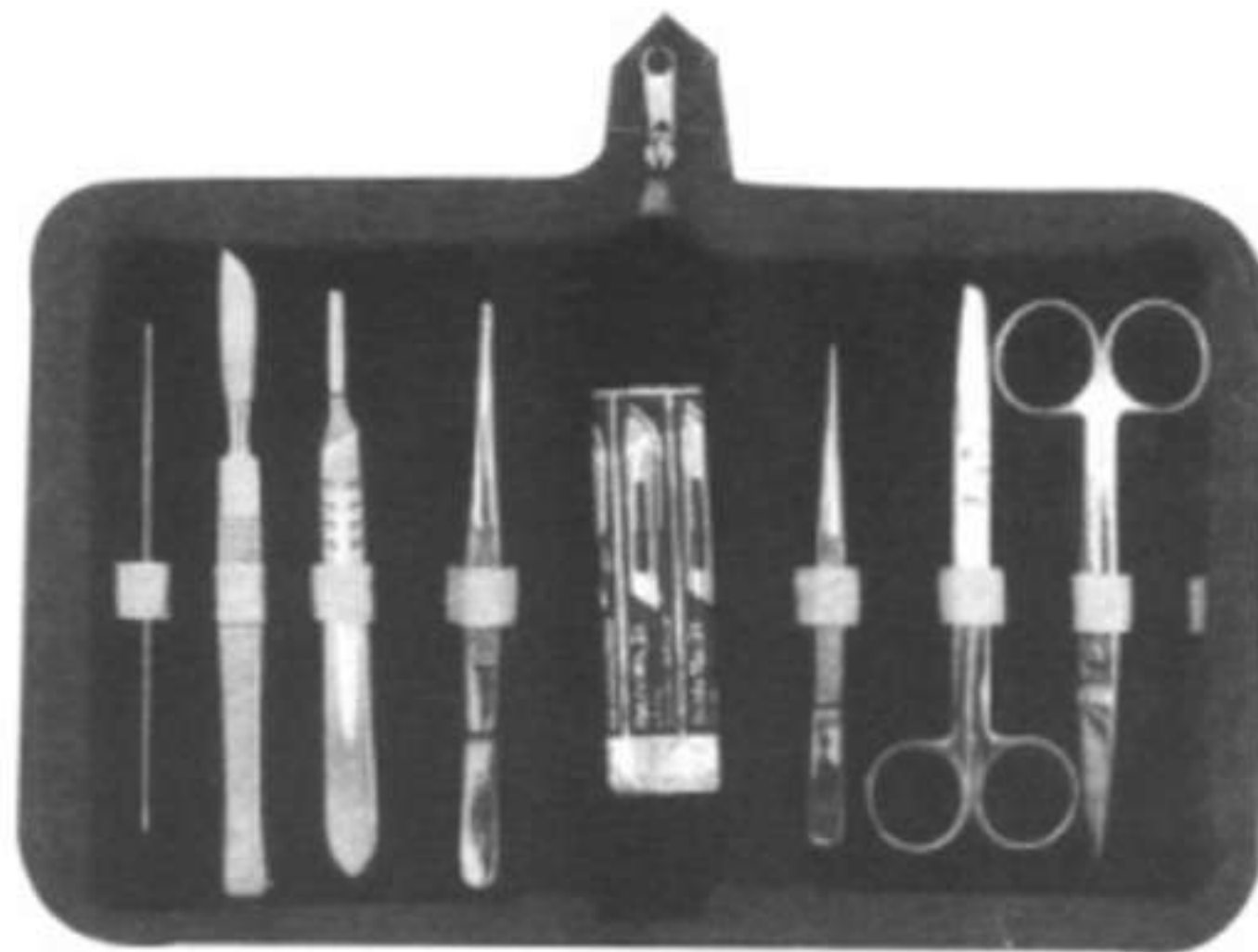

DMI-1-3420

- 1- Probe double 12.5 cm
- 2- Scalpel
- 3- B.P Handle No. 44
- 4- 6 PCS Blade 2 each no. 21, 22, 23
- 5- Dissecting Forcep 12.5 cm
- 6- Dissecting Forcep 11.5 cm sharp Point
- 7- Dissecting Scissor S/B STR 13 cm
- 8- Dissecting Scissor S/S STR 13 cm

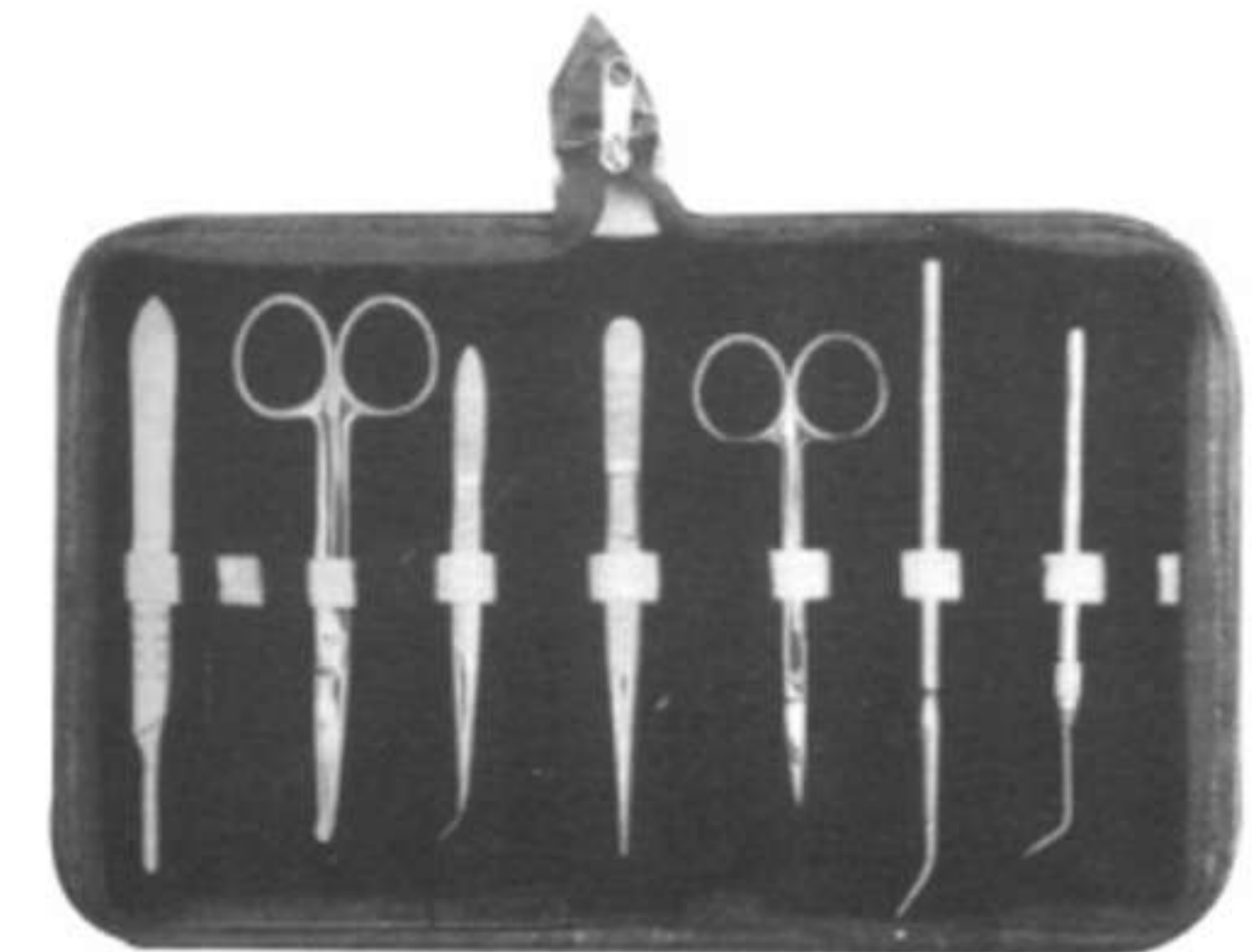

DMI-1-3421

- 1- Teasing Needle with Chuck CVD
- 2- Huber Probe
- 3- Iris Scissor
- 4- Dissecting Forcep Fine 14 cm
- 5- Dissecting Forcep Fine CVD. 12 cm
- 6- Operating Scissor with Probe 14 cm
- 7- B.P. Handle no. 4



DMI-1-3422

- 1- Probe with eye
- 2- Dissecting Forcep cvd fine 12 cm
- 3- Iris Scissor
- 4- Operating Scissor S/B str 14 cm
- 5- Grooved Director and Tongue tie
- 6- Huber Probe
- 7- Triple Chain Hook
- 8- B.P Handle No. 49
- 9- B.P Handle No. 310
- 10- Teasing Needle with Chuck cvd
- 11- Teasing Needle with Chuck str
- 12- Dissecting Forceps Fine 14 cm.

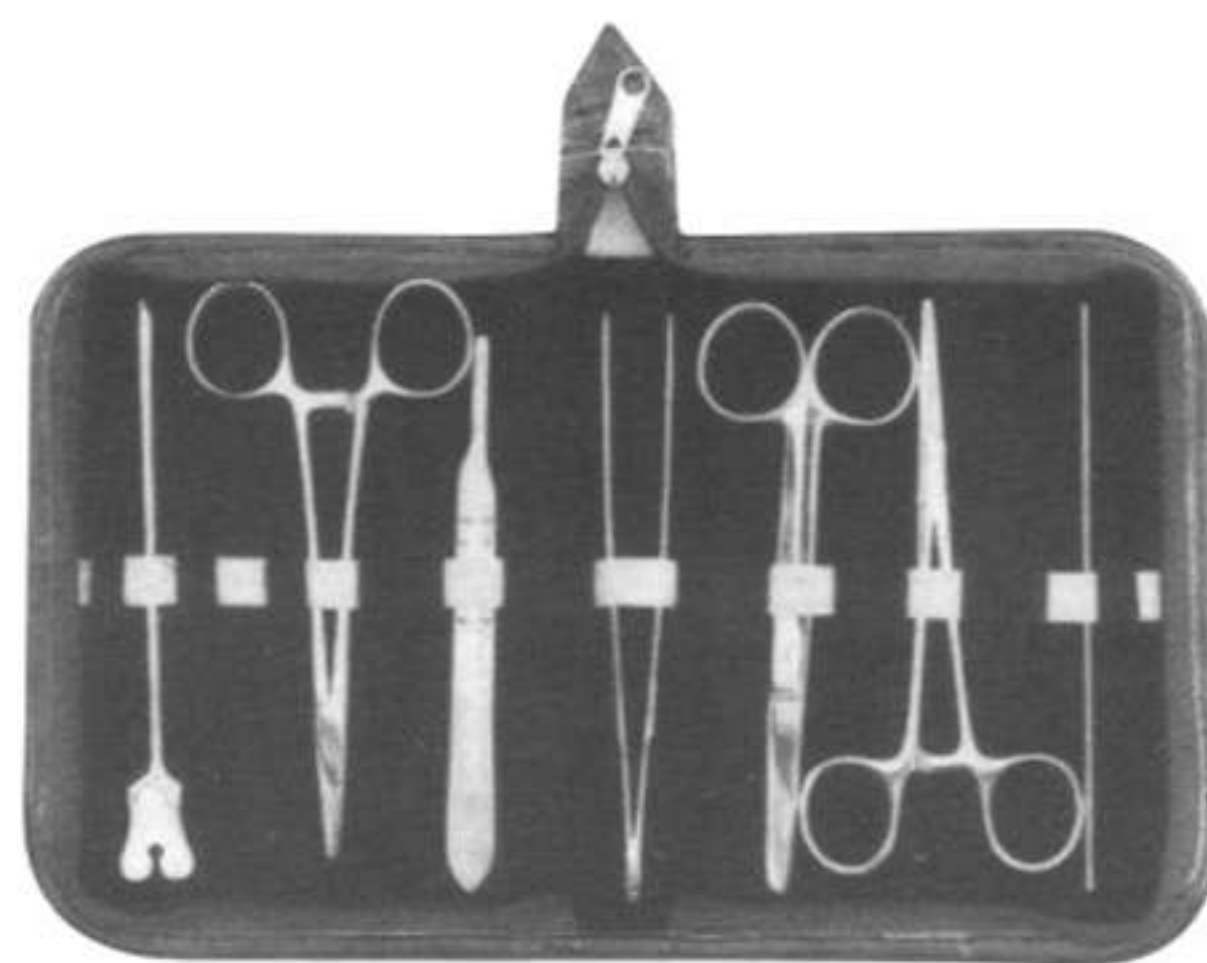

DMI-1-3423

- 1- Grooved Director and Tongue tie
- 2- Mayo Hearn Needle Holder 14 cm
- 3- B.P Handle No. 44
- 4- Dissecting Forceps Thump 14 cm
- 5- Operating Scissor S/B str 14 cm
- 6- Kelly Forcep STR 14 cm
- 7- Probe Double end

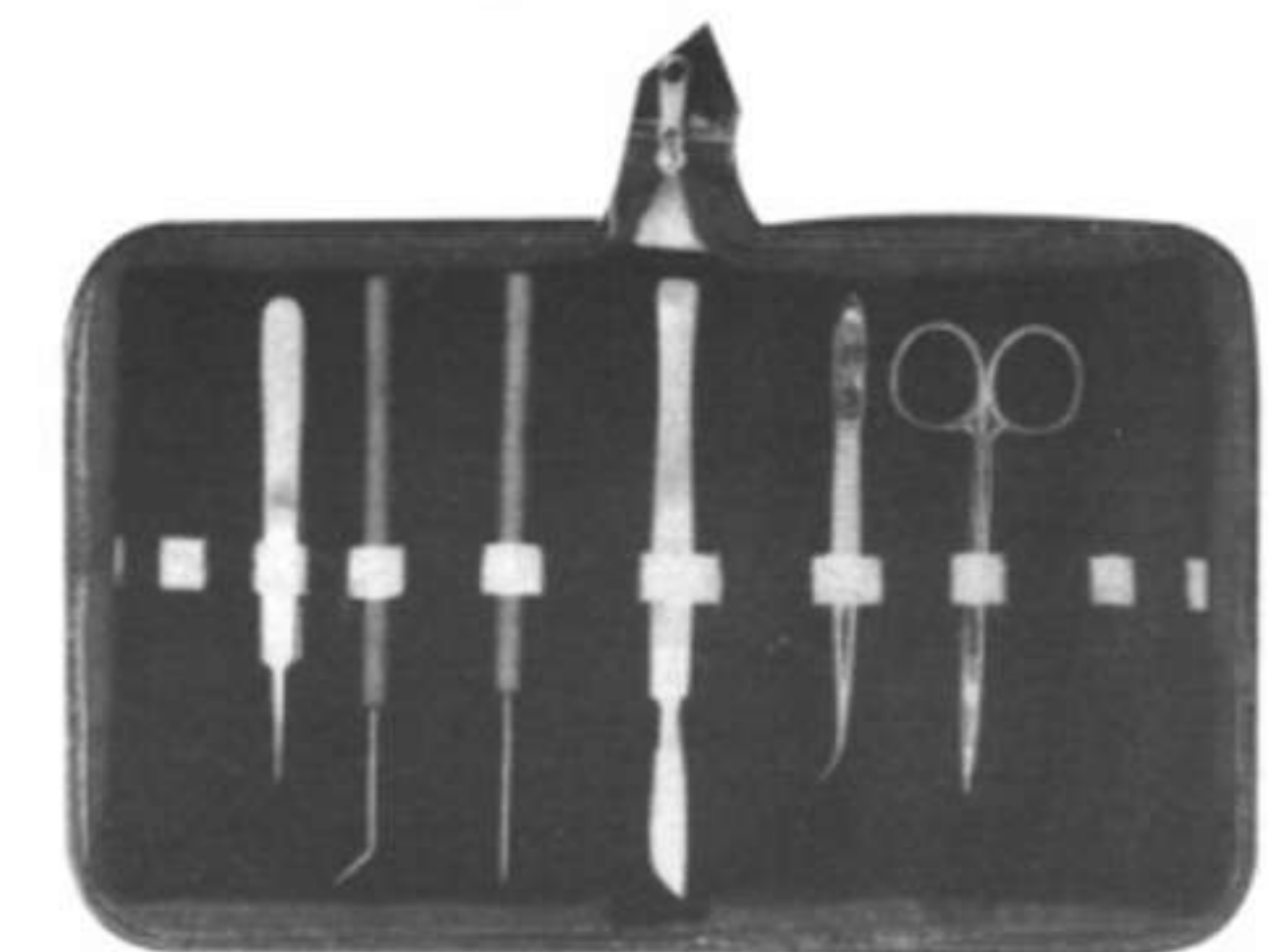

DMI-1-3424

- 1- Iris Scissor STR
- 2- Dissecting Forceps CVD 12 cm
- 3- Scalpel
- 4- Teasing Needle STR wooden handle
- 5- Teasing Needle CVD wooden handle
- 6- Watchmaker fine point.

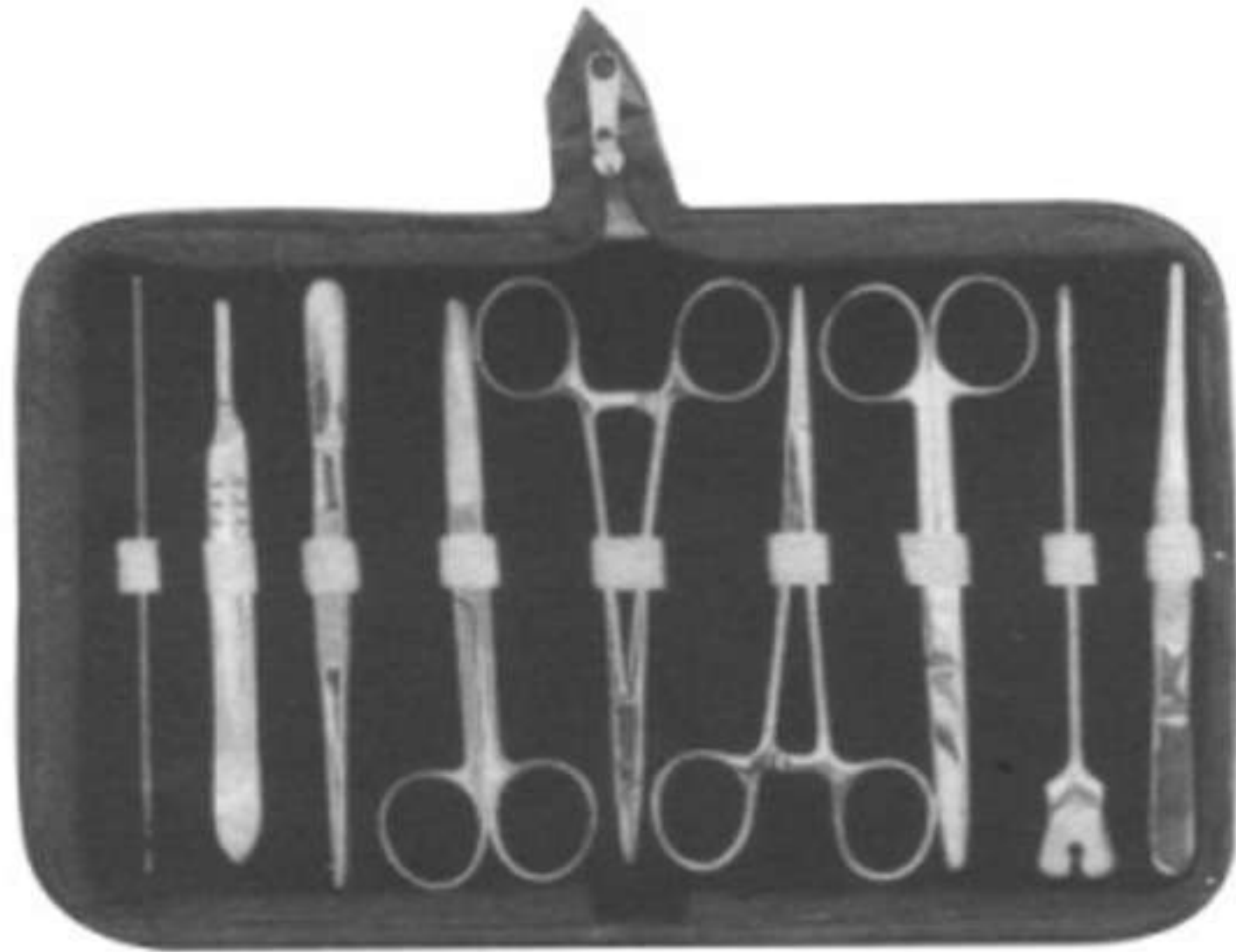

DMI-1-3425

- 1- Probe Double end
- 2- B.P Handle No. 43
- 3- Dissecting Forcep 1x2 Teeth 14 cm.
- 4- Operating Scissor S/B str 14 cm
- 5- Mayo Herg Needle Holder 14 cm
- 6- Kelly Forcep STR 14 cm.
- 7- Operating Scissor S/B CVD 14 cm
- 8- Grooved Director and Tongue tie
- 9- Dissecting Forceps Thumb 14 cm.

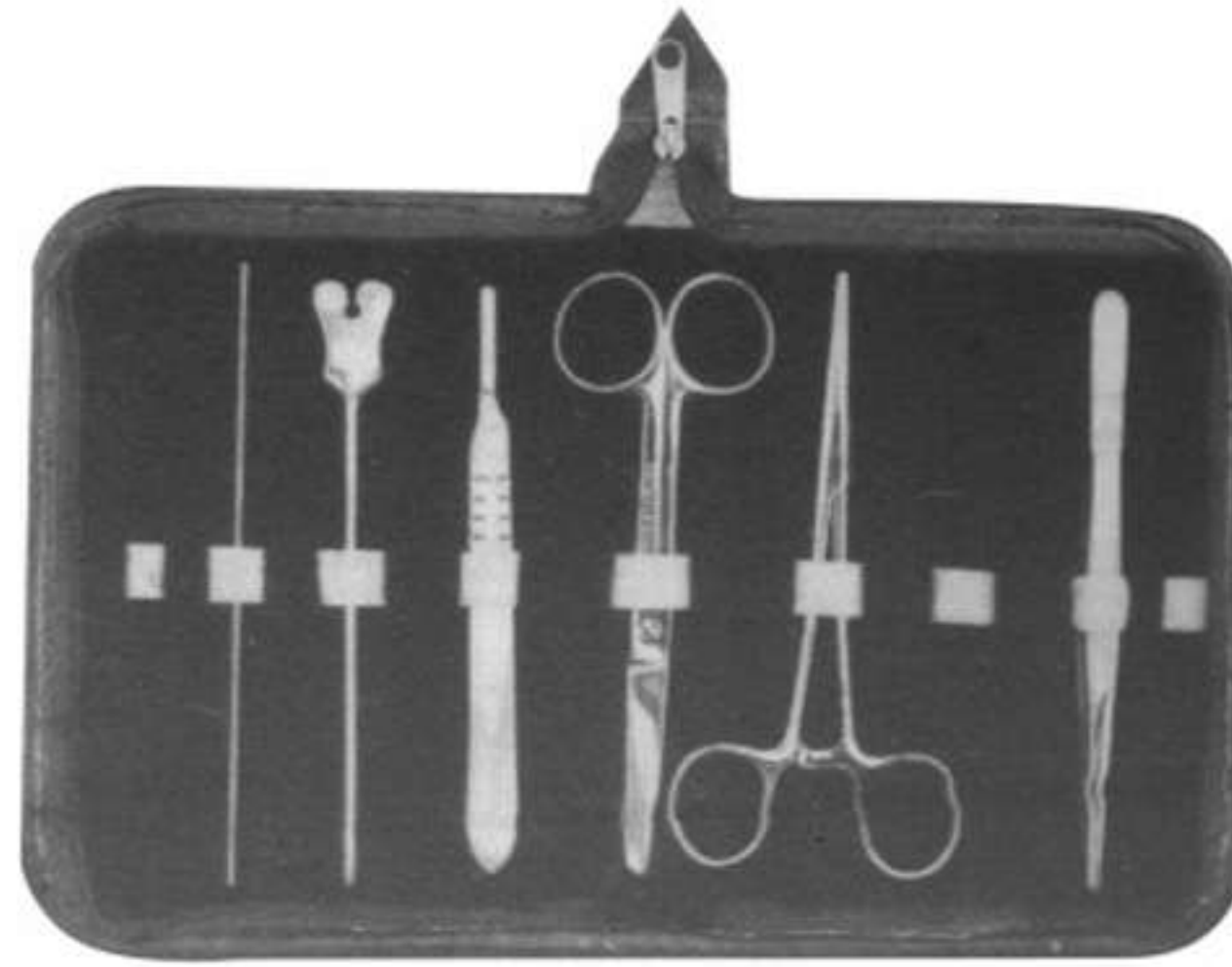

DMI-1-3426

- 1- Probe double end.
- 2- Grooved director and tounge tie.
- 3-B.P handle no.
- 4- Operating scissor STR S/b14cm.
- 5- Kelly forceps STR 14cm.
- 6- Dissecting forceps thumb 13cm.

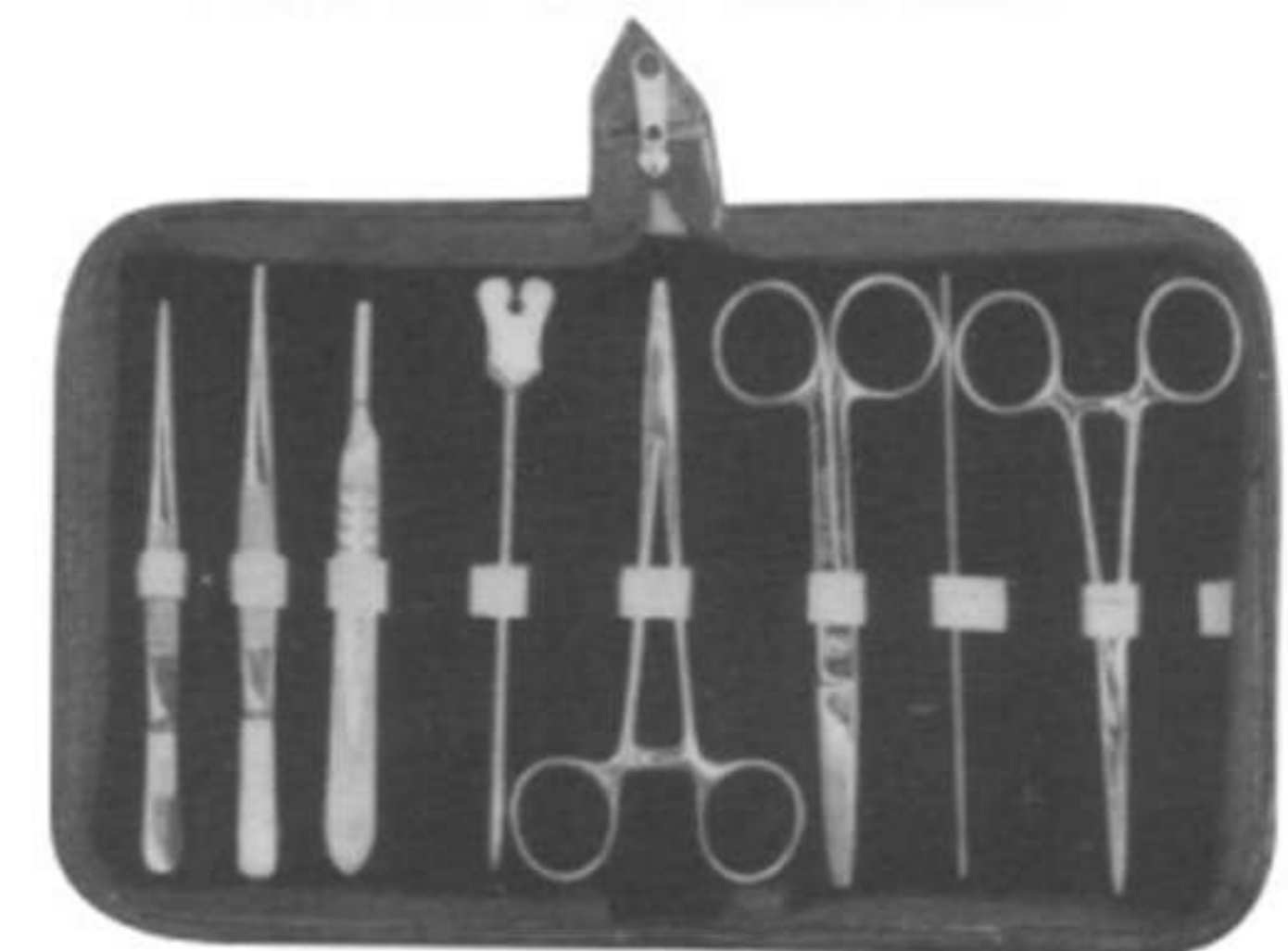

DMI-1-3427

- 1- Dissecting Forceps Thumb 14 cm
- 2- Dissecting Forcep 1x2 Teeth 14 cm.
- 3- B.P Handle No. 34
- 4- Grooved Director and Tongue tie
- 5- Mayo Herg Needle Holder 14 cm
- 6- Operating Scissor S/B str 14 cm
- 7- Probe Double end
- 8- Kelly Forcep STR 14 cm.

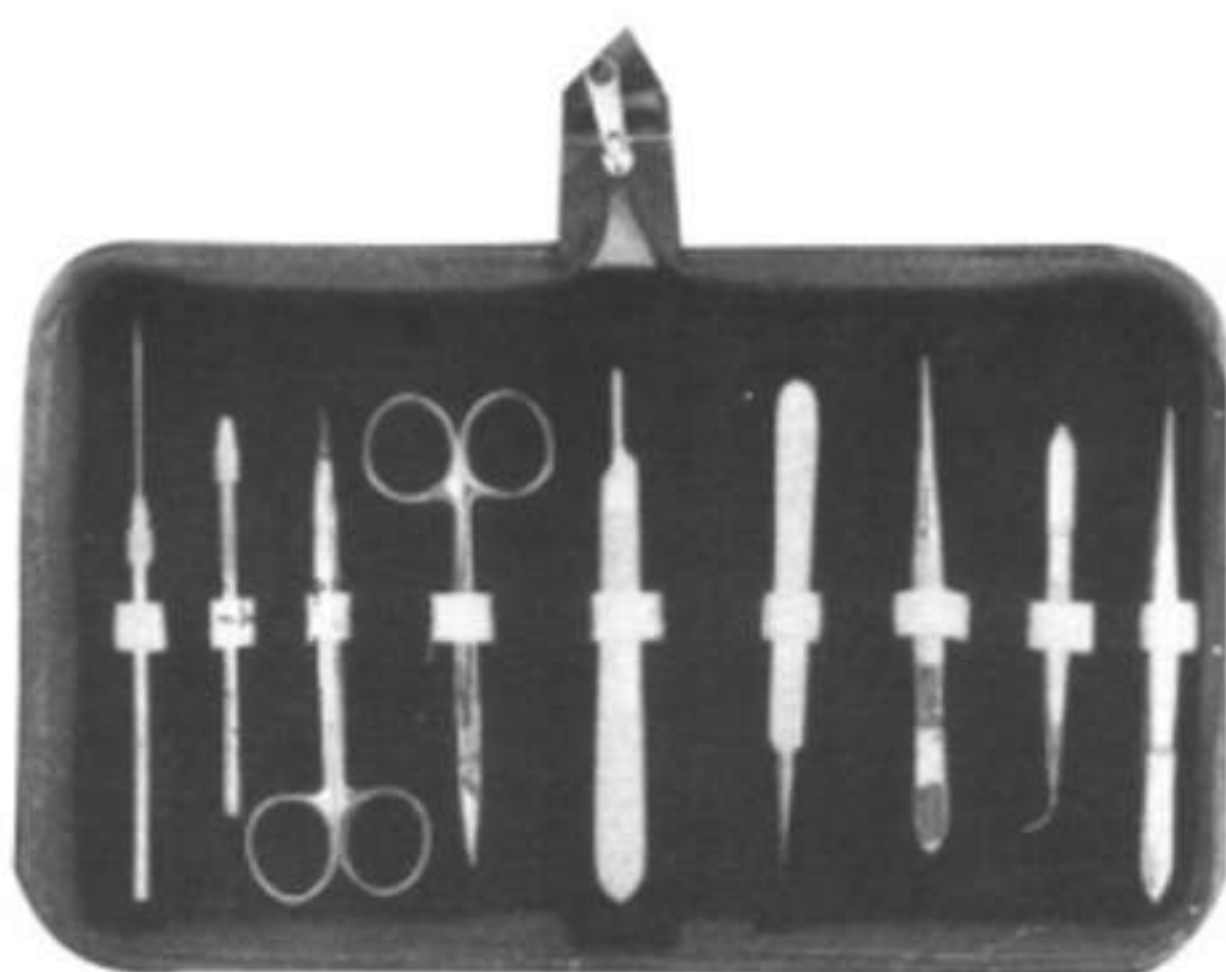

DMI-1-3428

- 1- Dissecting Forcep Fine 14cm.
- 2- Dissecting Forcep Fine CVD 12cm
- 3- Dissecting Forcep with Pin 14cm.
- 4- Watchmaker Fine point
- 5- Iris scissor STR
- 6- Iris scissor CVD.
- 7- Teasing Needle holder
- 8- Teasing Needle STR.
- 9- B.P. Handle no. 3



DMI-1-3429

- 1- Teasing Needle STR.
- 2- Grooved Director and Tongue Tie.
- 3- Teasing Needle CVD.
- 4- Dissecting Forcep with Pin 12 cm Fine
- 5- Operating Scissor S/B STR 14 cm
- 6- Triple Chain Hook
- 7- Probe with eye
- 8- Probe Double end
- 9- Probe and Hook
- 10- Dissecting Forcep Fine 14 cm
- 11- Iris Scissor
- 12- Huber Probe
- 13- B.P. Handle no.
- 314- B.P. Handle no.4



DMI-1-3430

- 1- Dissecting forcep fine STR with pin 12cm.
- 2- Iris scissor STR.
- 3- Probe with eye.
- 4- Probe and hook.
- 5- Operating scissor S/B STR 14cm
- 6- Triple chain hook.
- 7- B.P. handle no.
- 48- Humber probe.
- 9- B.P.handle no.
- 310- Teasing needle STR plastic handle.
- 11- Teasing needle CVD plastic handle.
- 12- Grooved director and tounge tie.
- 13- Probe double end.

Suction Instruments



DMI-1-3431

1- Dissecting Forceps Thumb 14 cm. 2- Dissecting Forcep 1x2 Teeth 14 cm. 3- B.P Handle No. 34- Grooved Director and Tongue tie 5- Mayo Hearg Needle Holder 14 cm 6- Operating Scissor S/B str 14 cm 7- Probe Double end 7- Kelly Forcep STR 14 cm.



DMI-1-3432
Schimmelbusch



DMI-1-3433

Box 120 x 65 x 13 mm
(without Bulldog clamps, without silicone tape)



DMI-1-3434

Box with support 120 x 65 x 13 mm
(ohne Bulldogklemmen)



DMI-1-3435

Box with support for needle
(electrodes, without instruments)

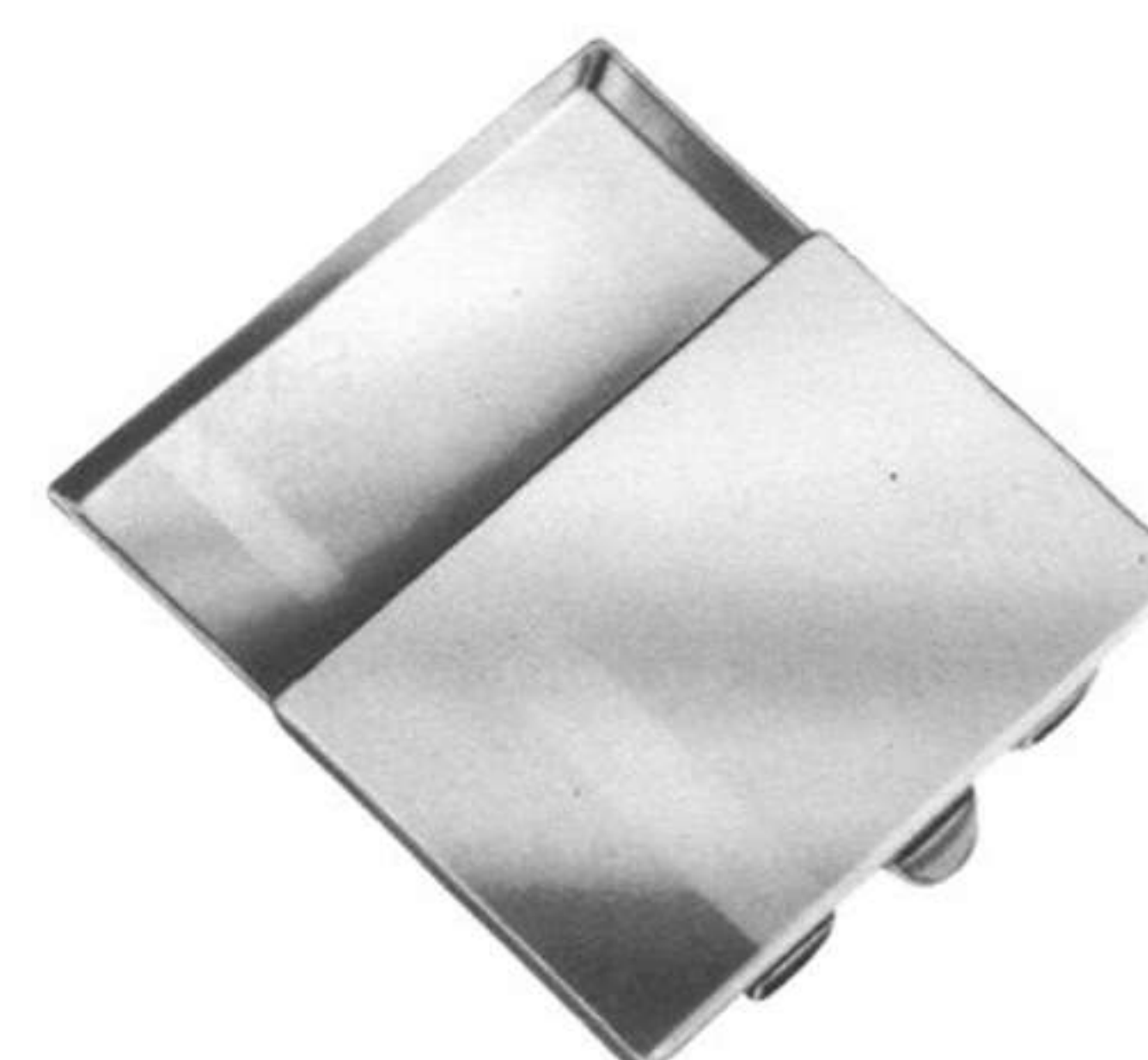

DMI-1-3436

50 x 25 x 4,5 mm 19-120 65 x 42 x 8 mm
19-121 75 x 25 x 4,5 mm



DMI-1-3437
65mm x 15mm



DMI-1-3438
Suction Instruments



DMI-1-3439
Martin Sterilizing Forceps consisting of: 1 Sterilizing Forceps, curved, 25 cm, without ratchet, with lid for jar 1 jar with bottom plate (an AS-tilt) ditto, with 32 cm long Sterilizing Forceps



DMI-1-3440
Suction Instruments



DMI-1-3441
205 x 105 x 35 mm



DMI-1-3442
Suction Instruments



DMI-1-3443
19-14925 cc



DMI-1-3444
19-15050 cc



DMI-1-3445
19-15120 cc Medicine Spoon



DMI-1-3446
19-152 75 x 12 mm Tablet Tray



DMI-1-3447
19-153 90 x 90 mm Metal Cup



DMI-1-3448
75 x 80 mm Sputum Cup



DMI-1-3449
Kidney Dish



DMI-1-3450
Suction Instruments



DMI-1-3451
Suction Instruments

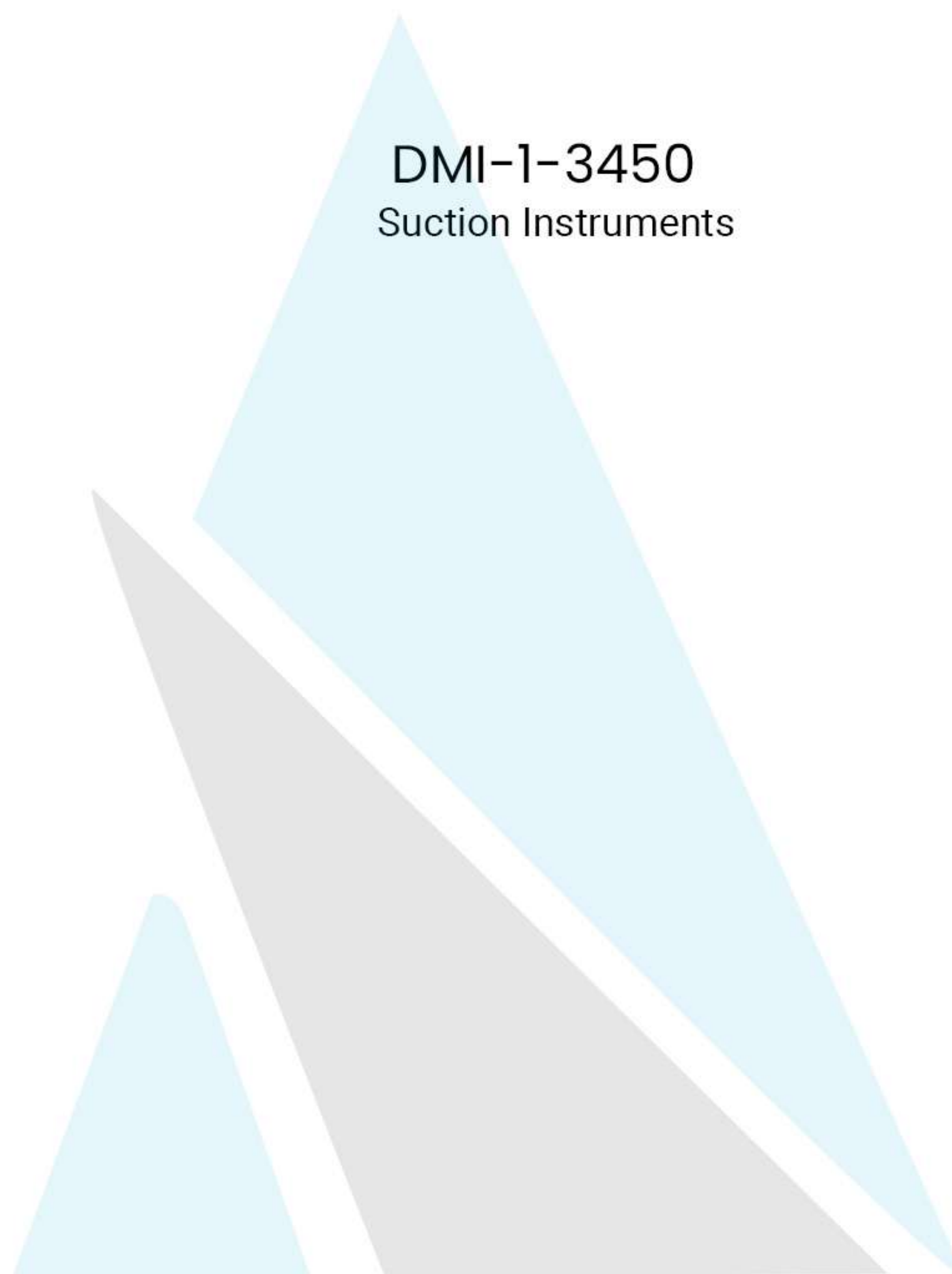

ART-DSC-1-3452
19-172100 cc 0.1L



ART-DSC-1-3453
Suction Instruments

Scissors With Tungsten Carbide Inserts



DMI-1-3501
Standard 14,5cm16,5cm18,5cm



DMI-1-3502
Standard 14,5cm16,5cm18,5cm

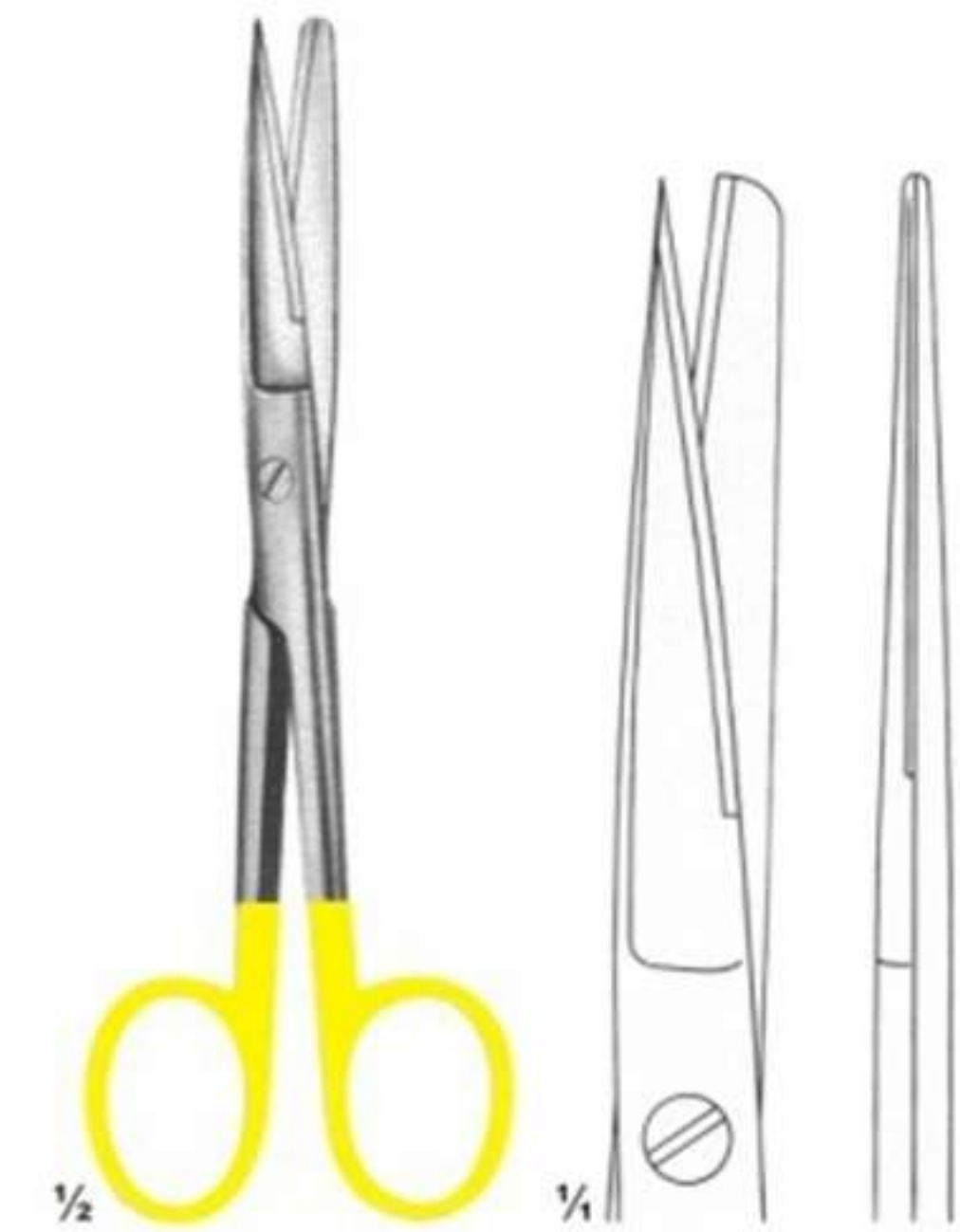

DMI-1-3503
Standard 14,5cm16,5cm18,5cm



DMI-1-3504
Standard 14,5cm16,5cm18,5cm



DMI-1-3505
Standard 14,5cm16,5cm18,5cm



DMI-1-3506
Standard 14,5cm16,5cm18,5cm

Scissors With Tungsten Carbide Inserts

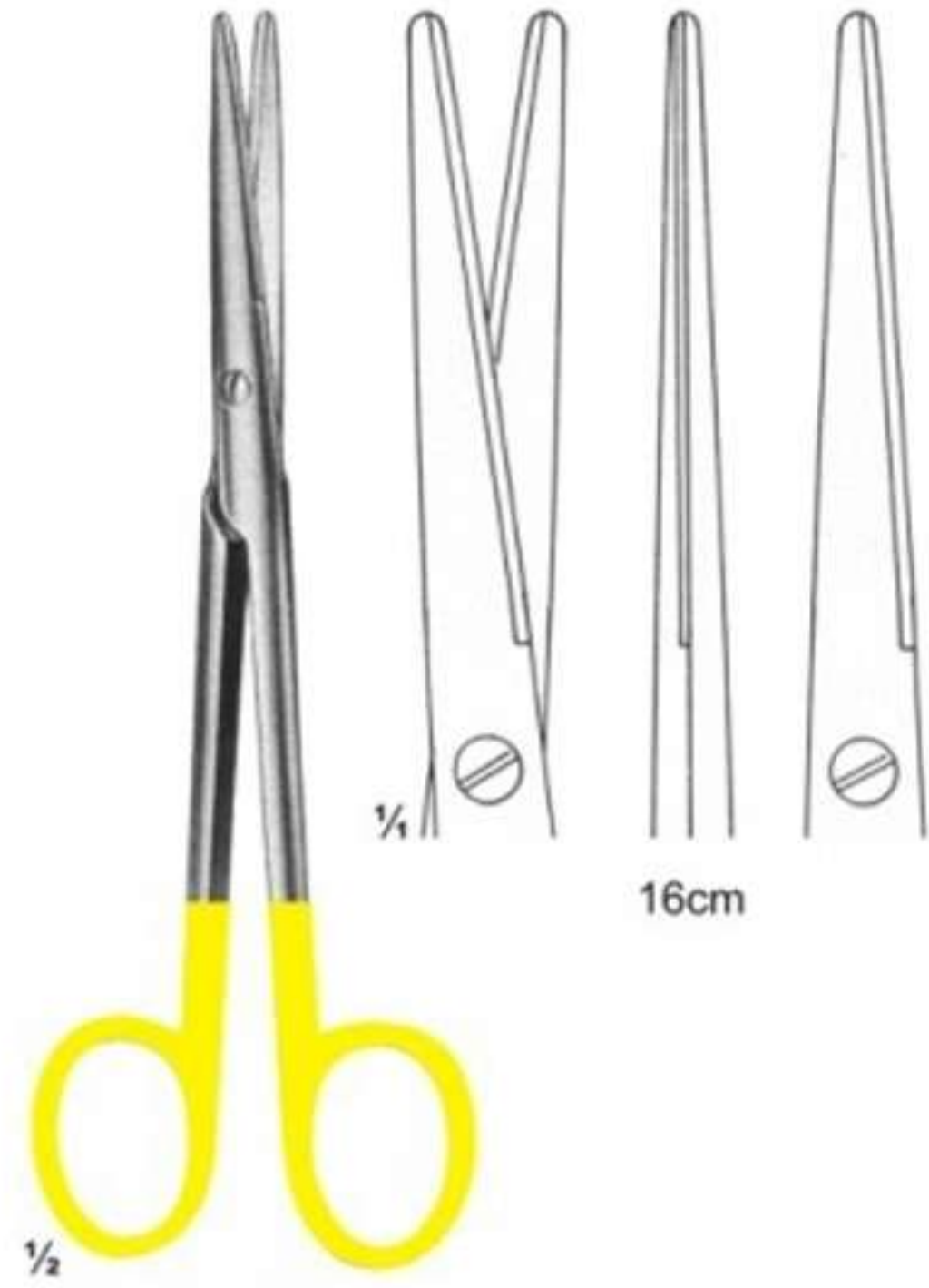

DMI-1-3507
Mayo-Lexer 16 cm

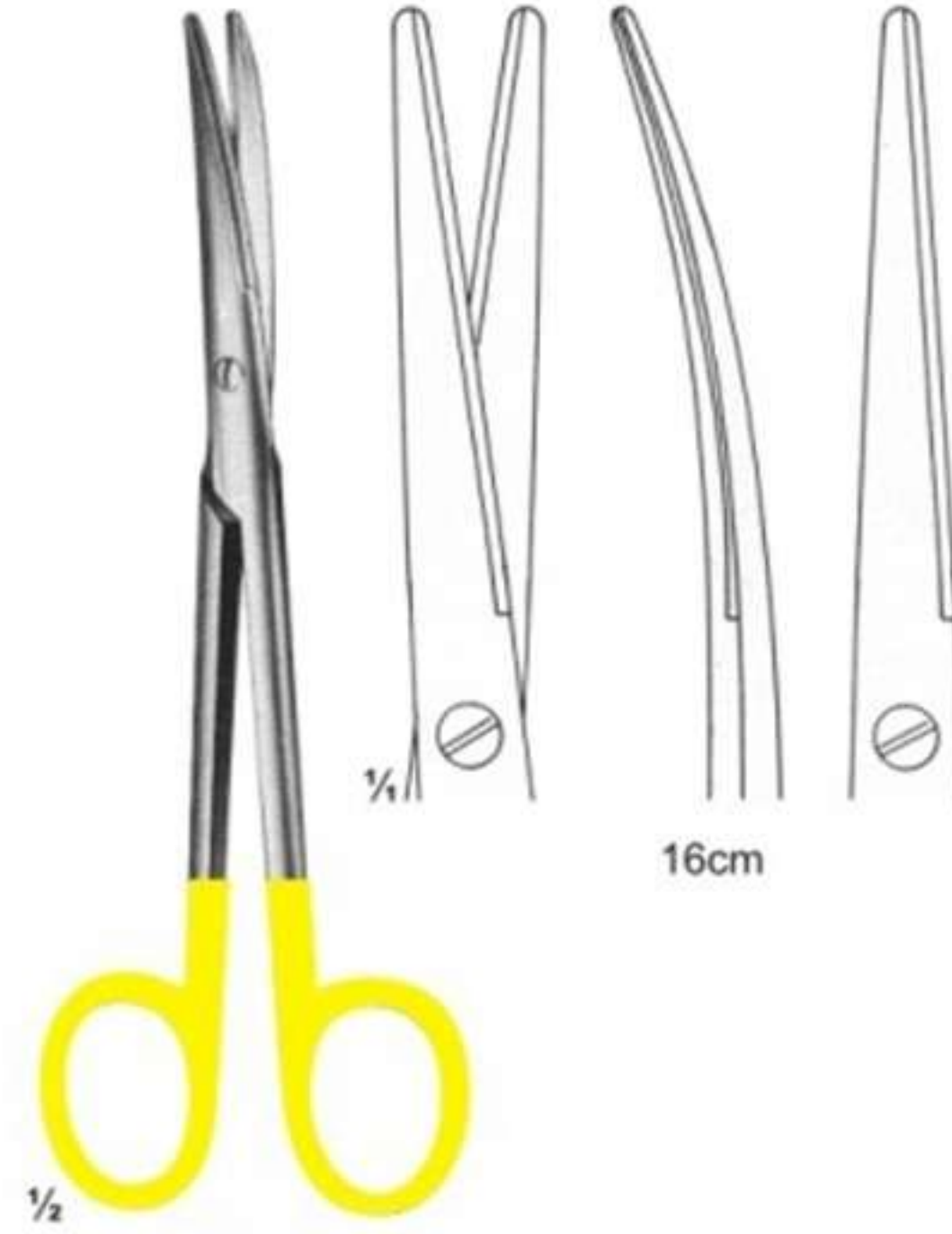

DMI-1-3508
Mayo-Lexer 16cm



DMI-1-3509
Lexer 16cm21cm

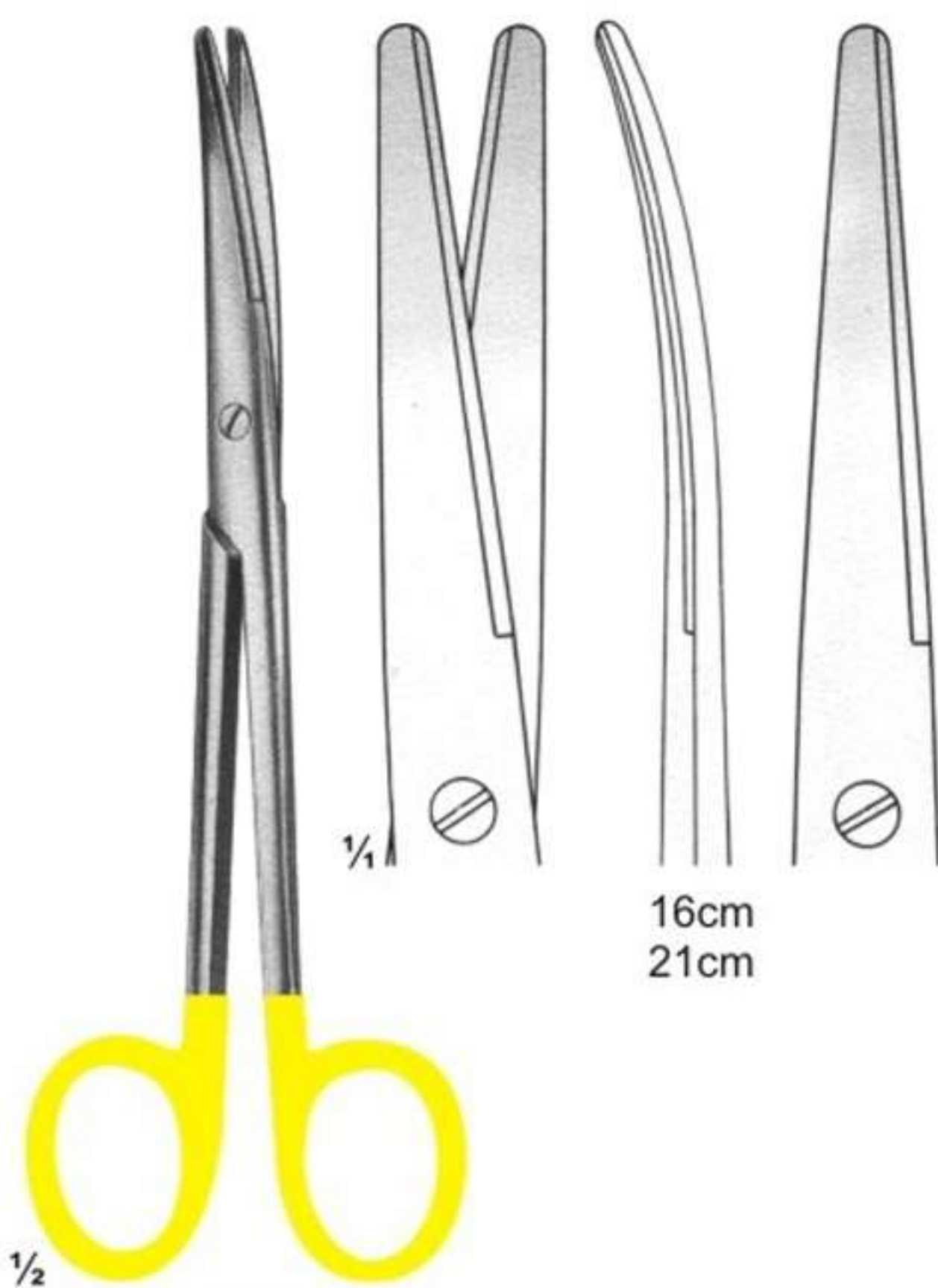

DMI-1-3510
Lexer 16cm21cm

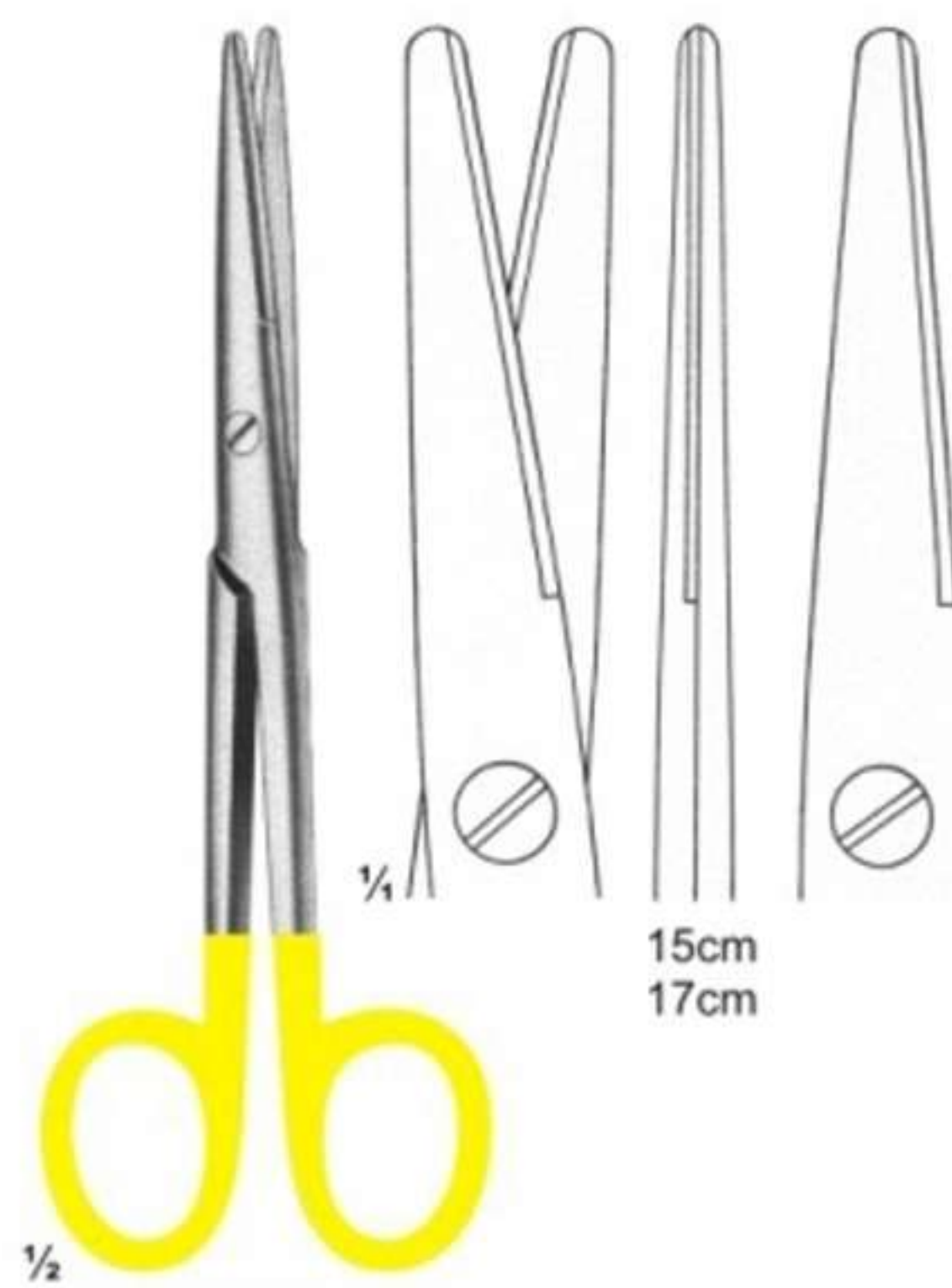

DMI-1-3511
Mayo-Stillle 15cm17cm

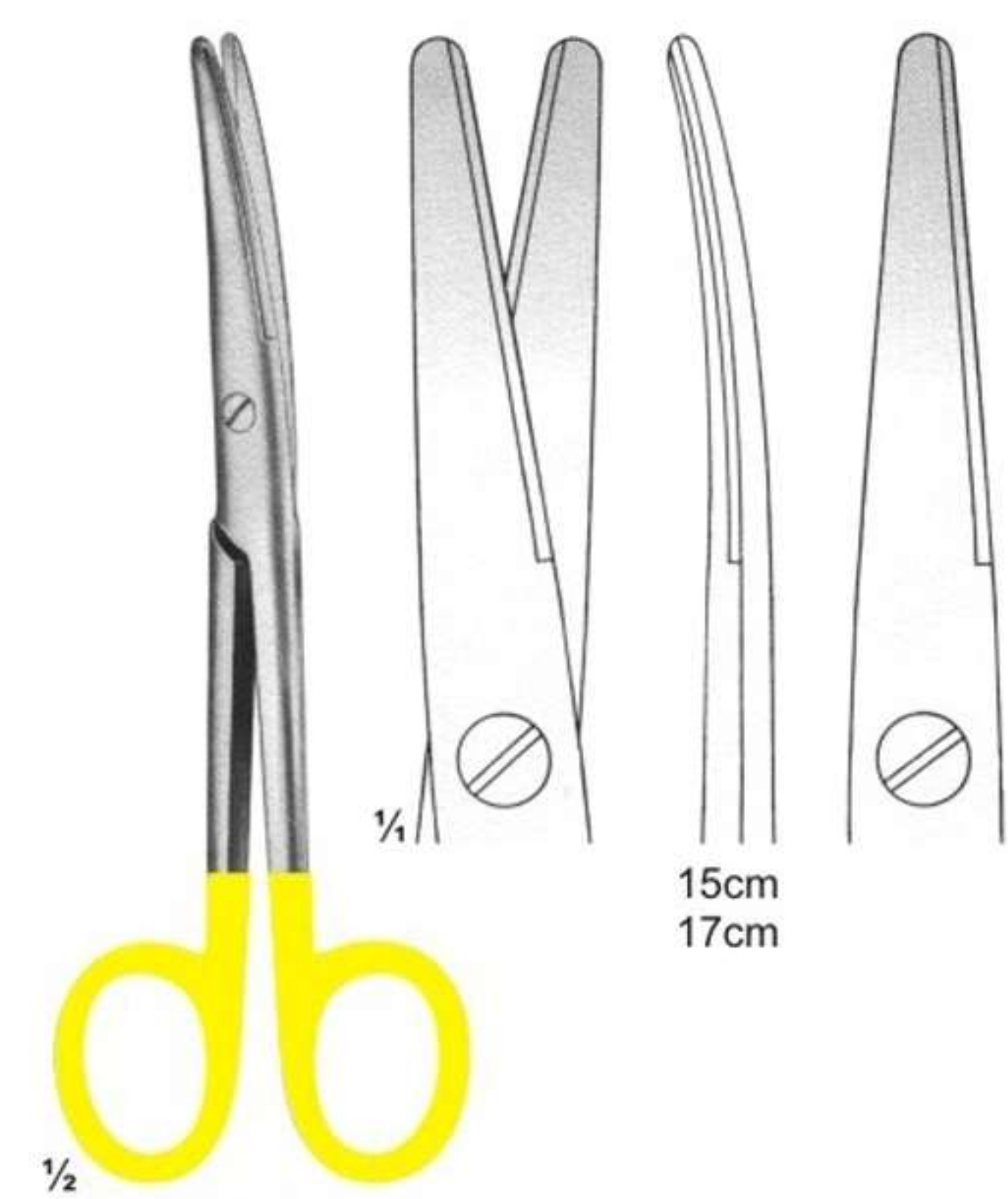

DMI-1-3512
Mayo-Stillle 15cm17cm

Scissors With Tungsten Carbide Inserts



DMI-1-3513
Metzenbaum
18cm 11,5cm 20cm 14,5cm 28cm 23,5cm 30cm 25,5cm



DMI-1-3514
Metzenbaum
11,5cm 14,5cm 23cm 25cm

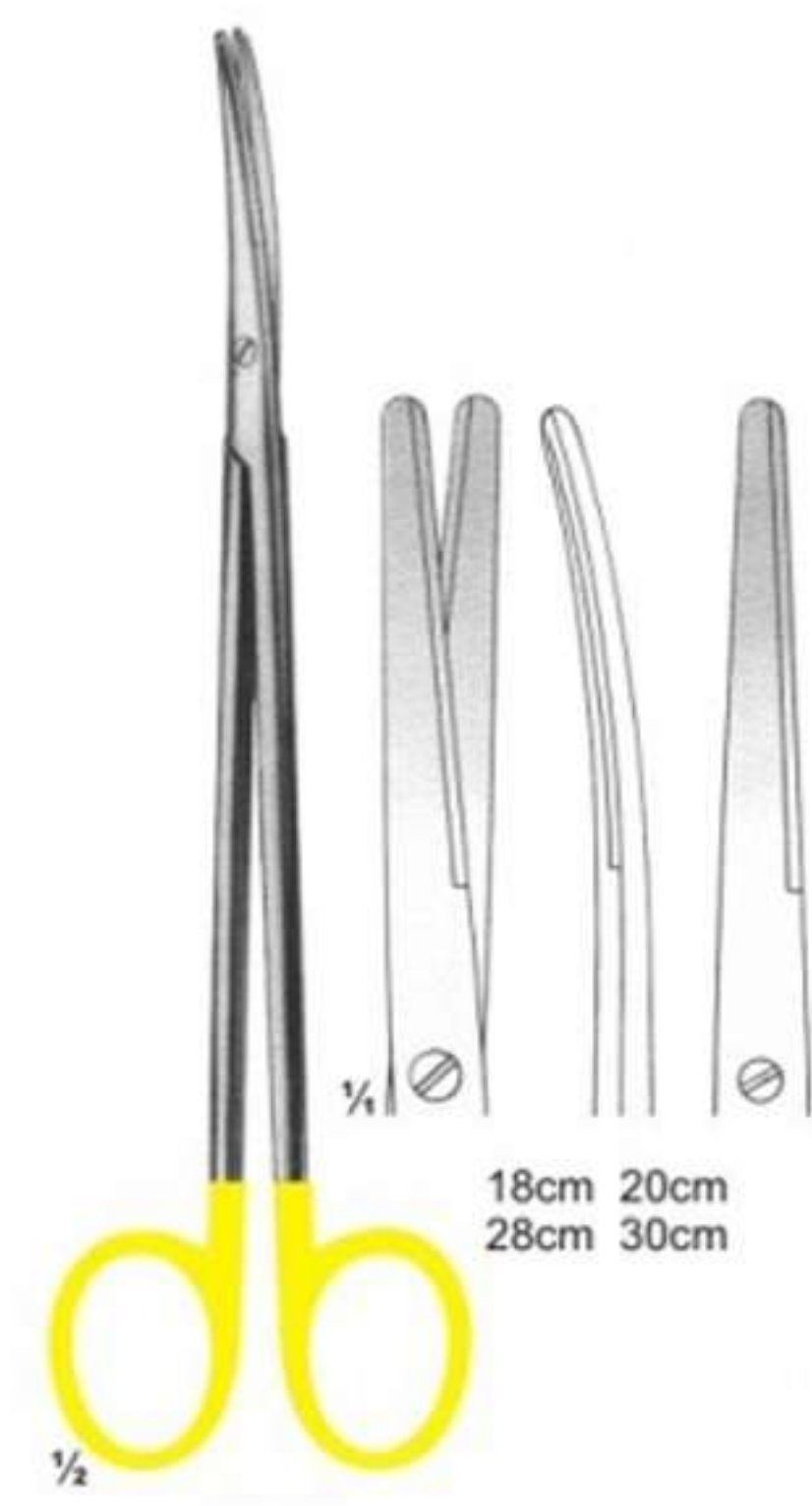

DMI-1-3515
Metzenbaum
18cm 20cm 28cm 30cm



DMI-1-3516
Metzenbaum-Fino
14cm 18cm 20cm 23cm 25cm 28cm



DMI-1-3517
Metzenbaum-Fino
14cm 18cm 20cm 23cm 25cm 28cm



DMI-1-3518
Metzenbaum-Fino
14cm 18cm 20cm 23cm

Scissors With Tungsten Carbide Inserts

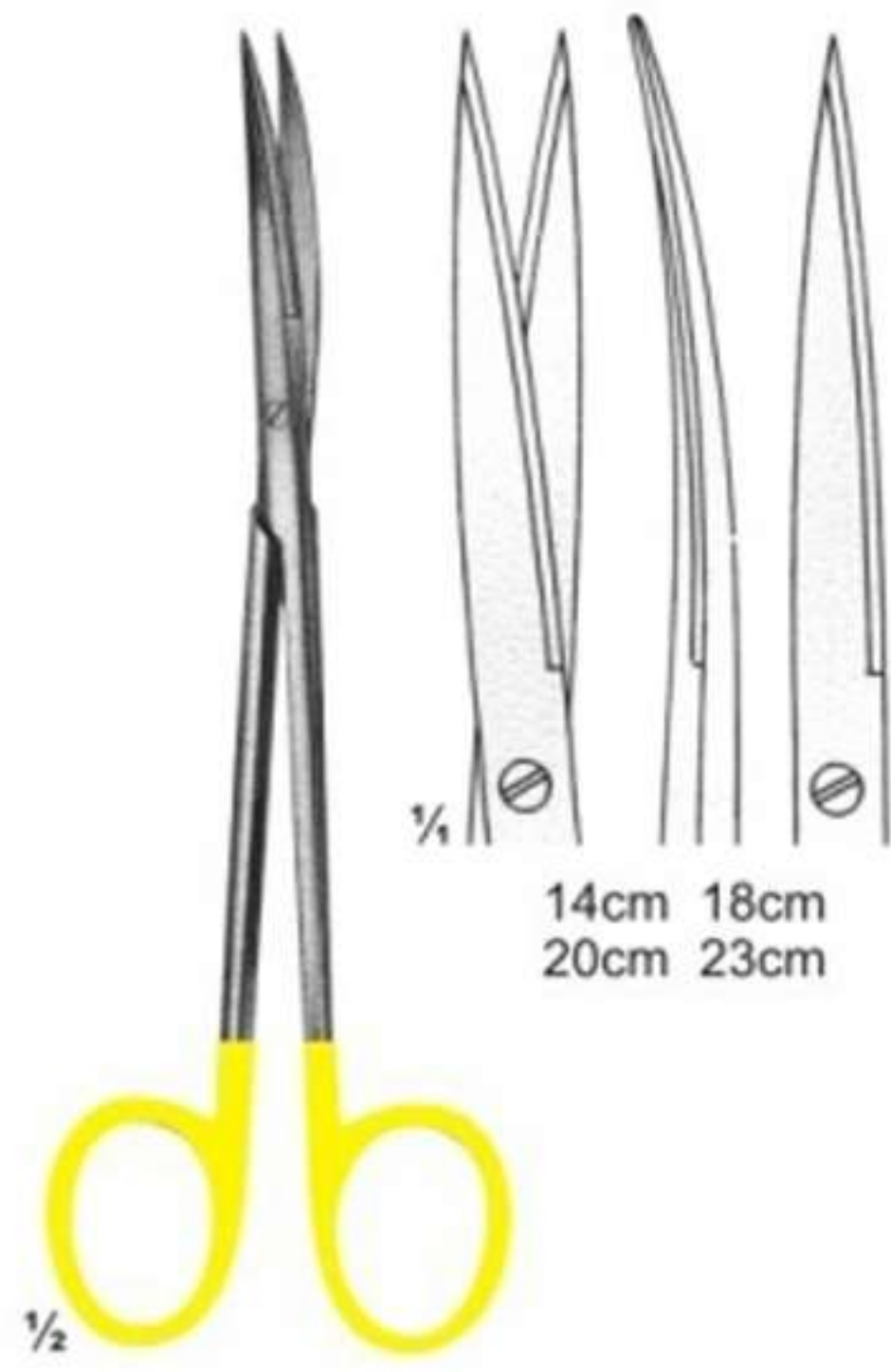

DMI-1-3519
Metzenbaum-Fino
14cm 18cm 20cm 23cm

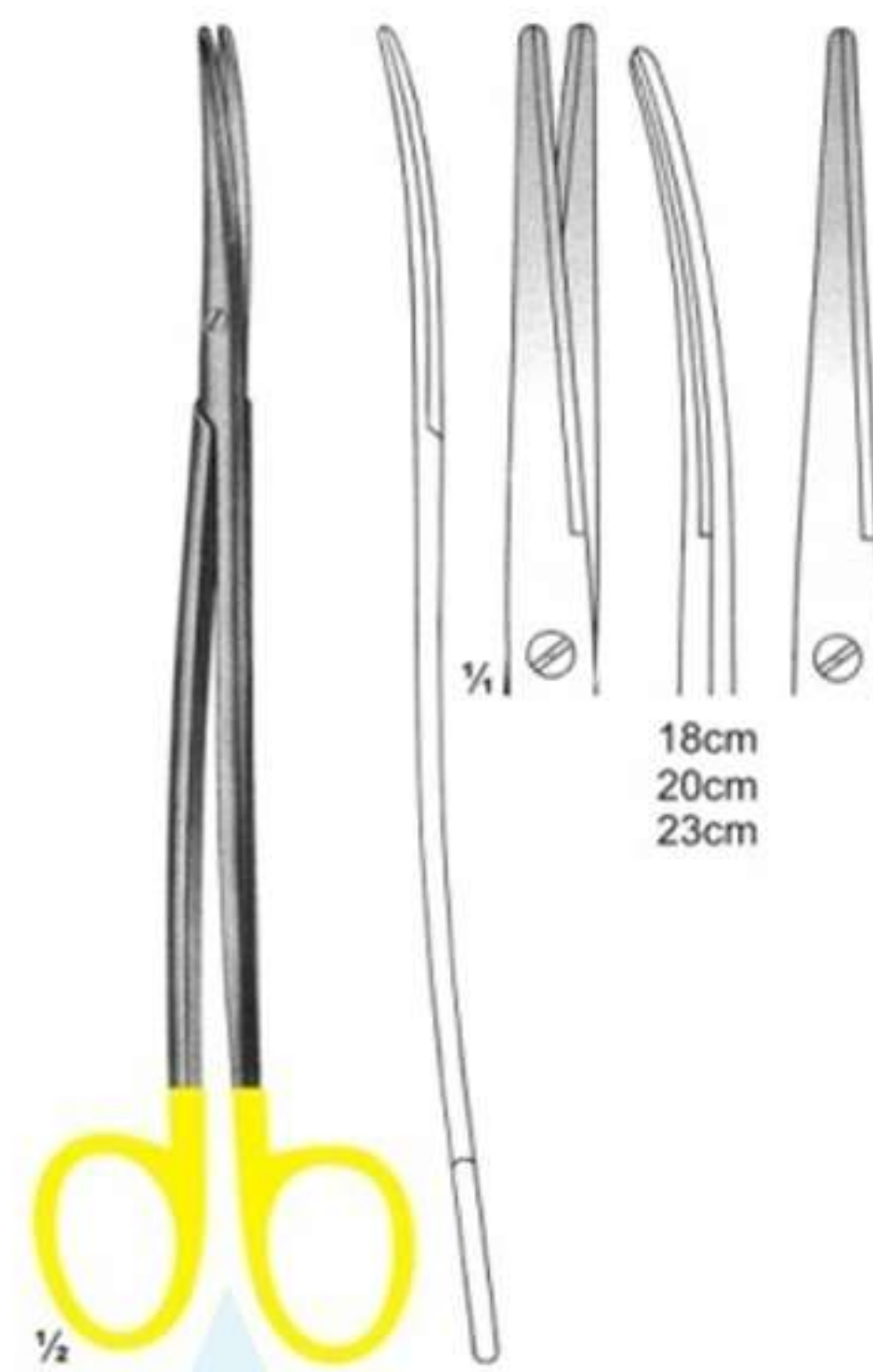

DMI-1-3520
Metzenbaum-Fino
18cm 20cm 23cm

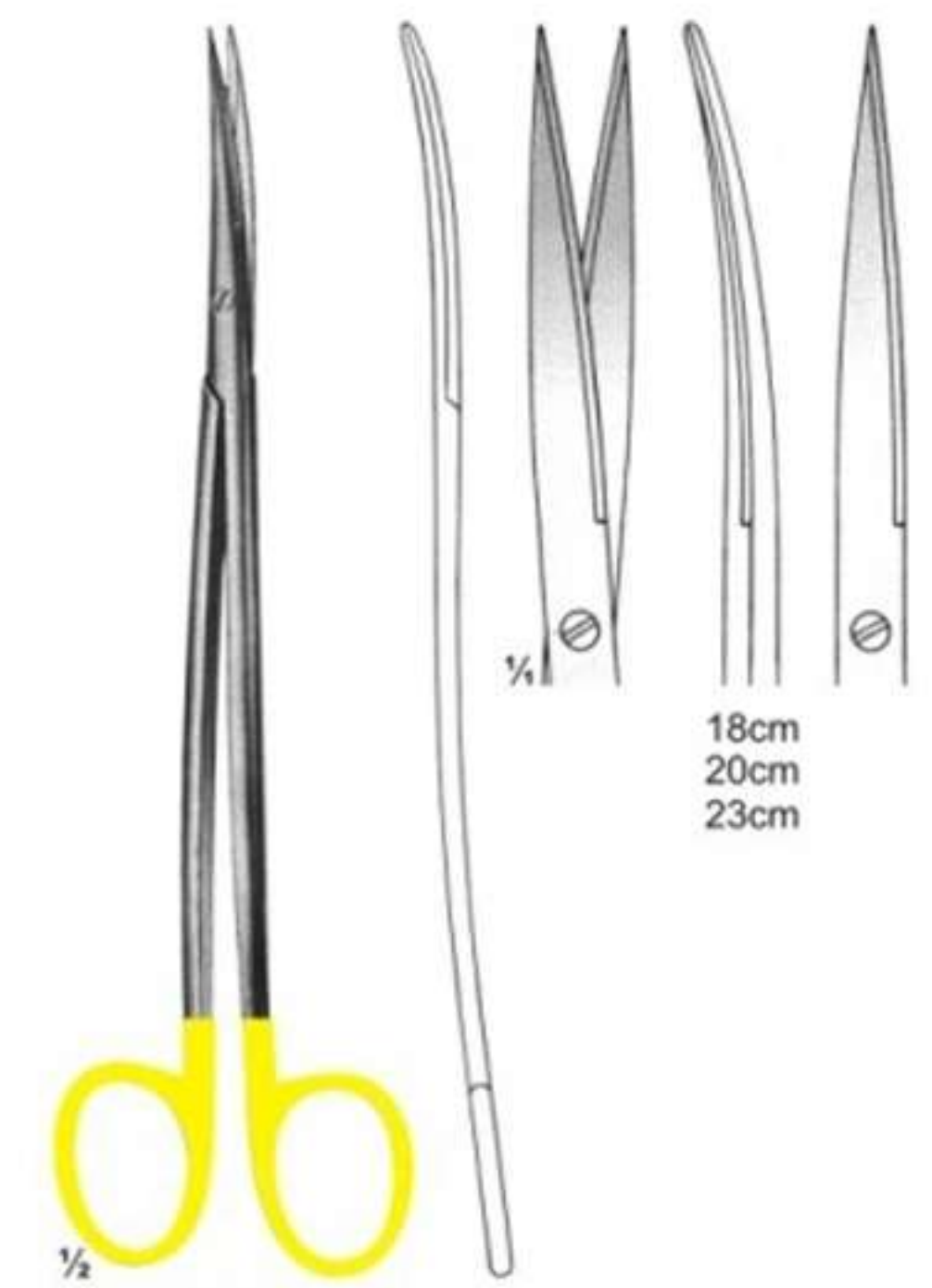

DMI-1-3521
Metzenbaum-Fino
18cm 20cm 23cm



DMI-1-3522
Metzenbaum
20cm 23cm

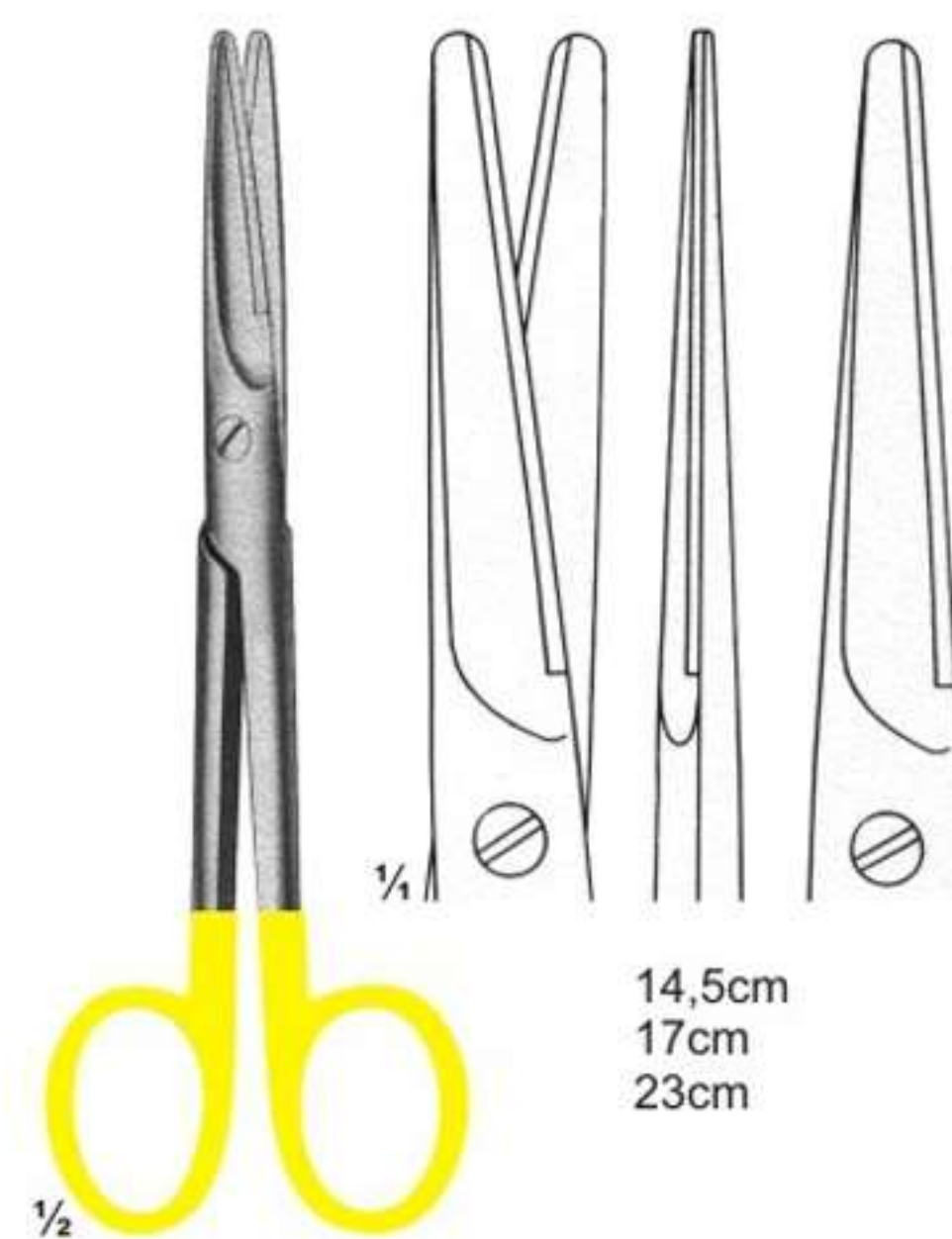

DMI-1-3523
Mayo
14,5cm 17cm 23cm

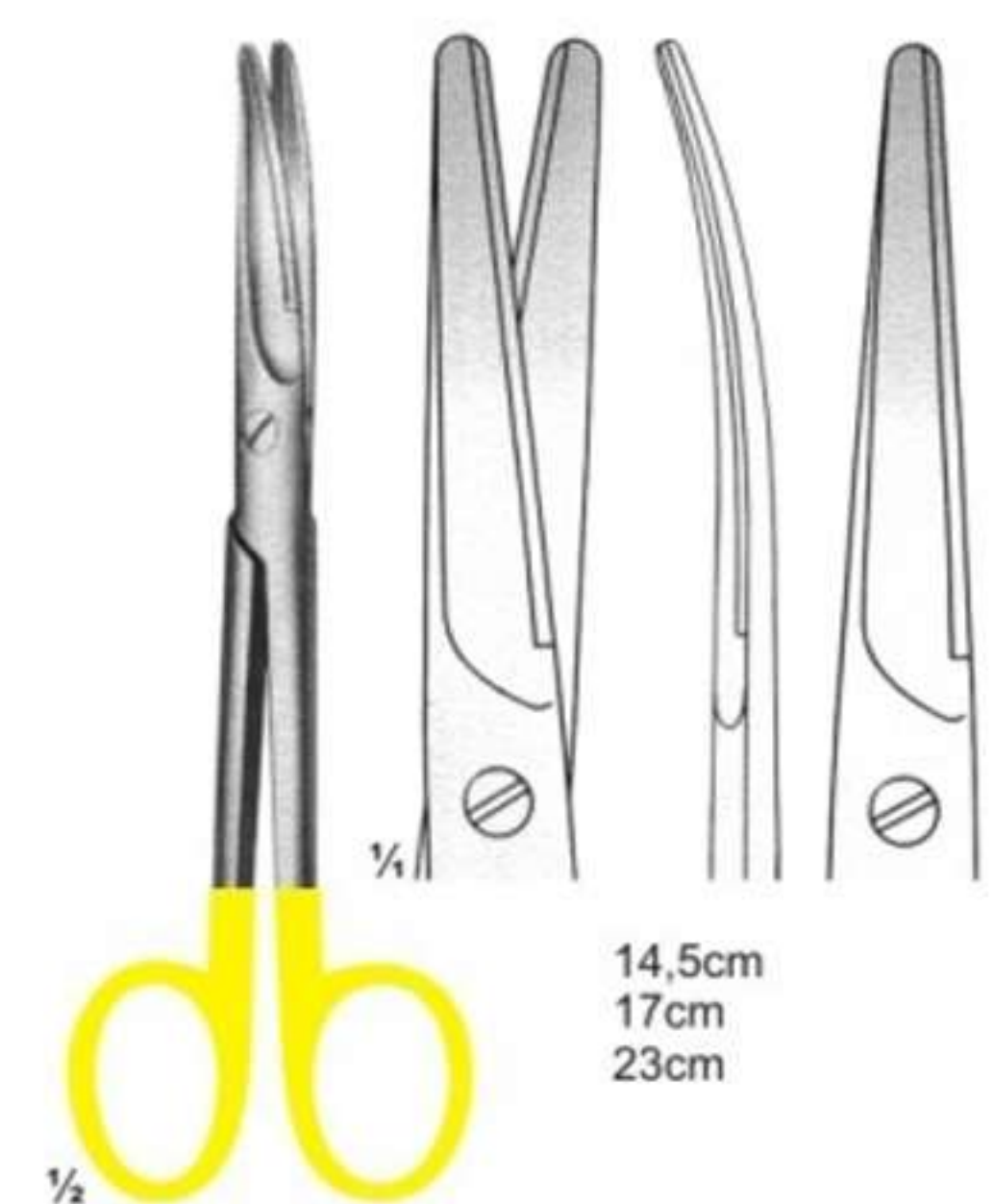

DMI-1-3524
Mayo
14,5cm 17cm 23cm

Scissors With Tungsten Carbide Inserts

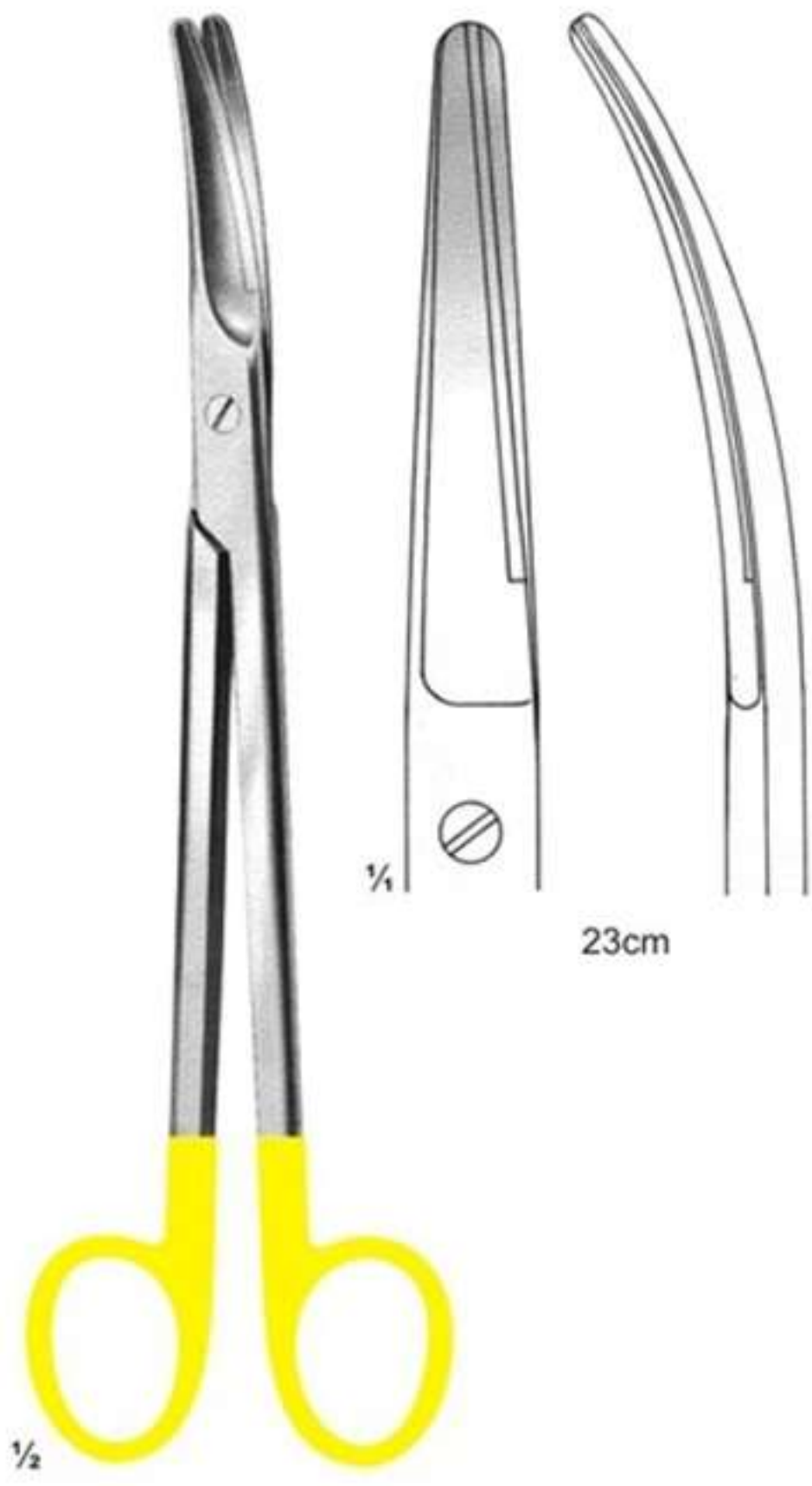

DMI-1-3525
Parametrium
23cm

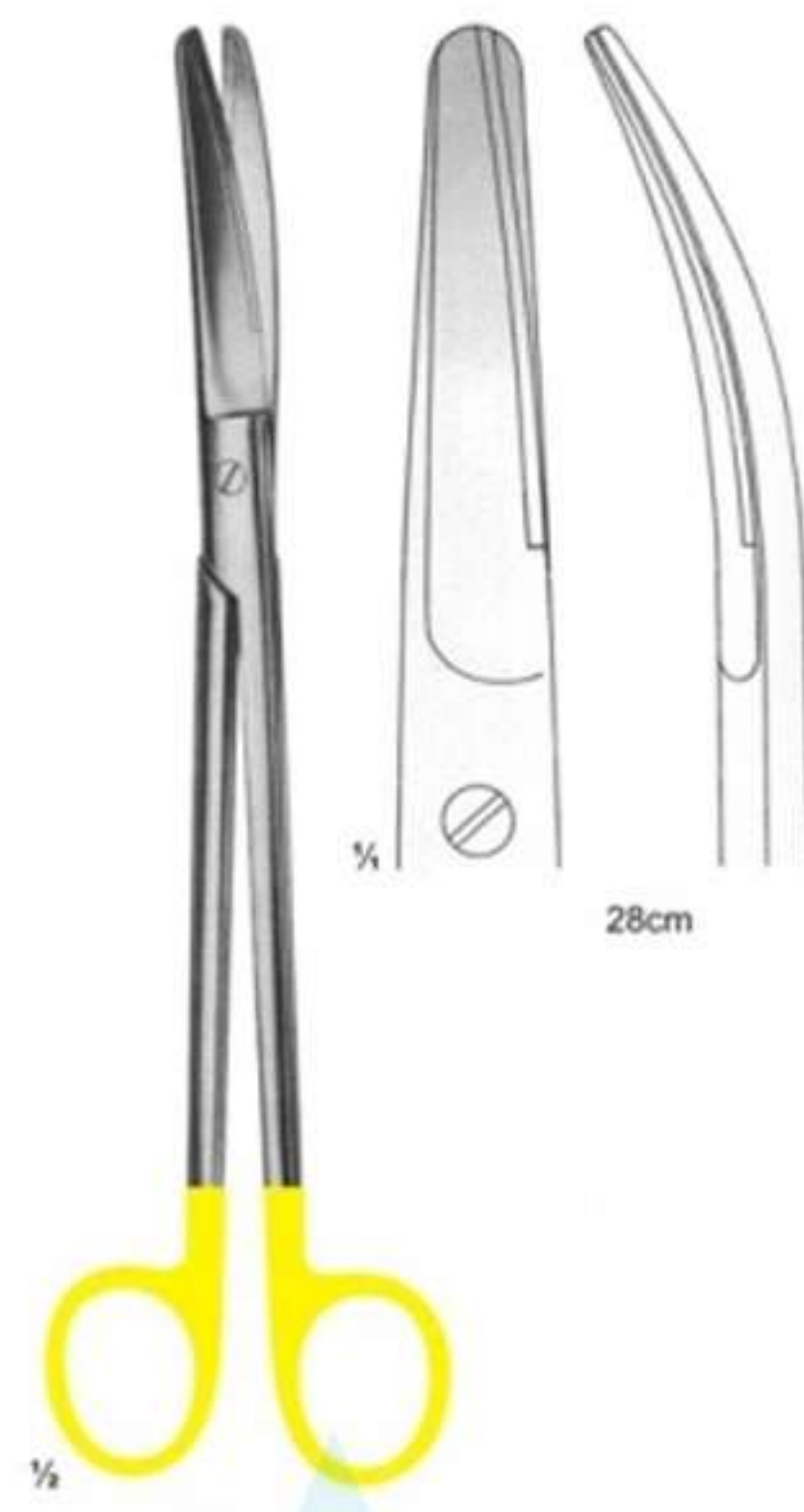

DMI-1-3526
Mayo-Harrington 28cm

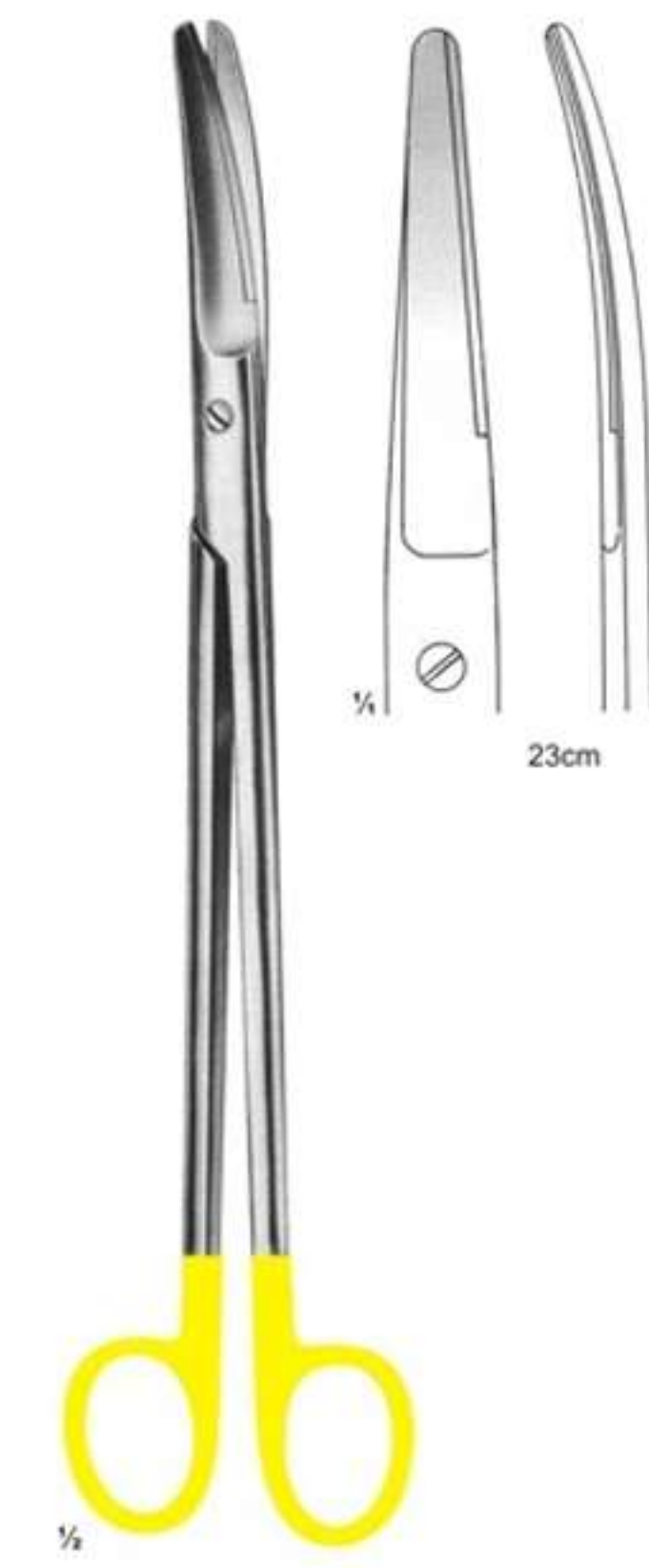

DMI-1-3527
Sims 23cm

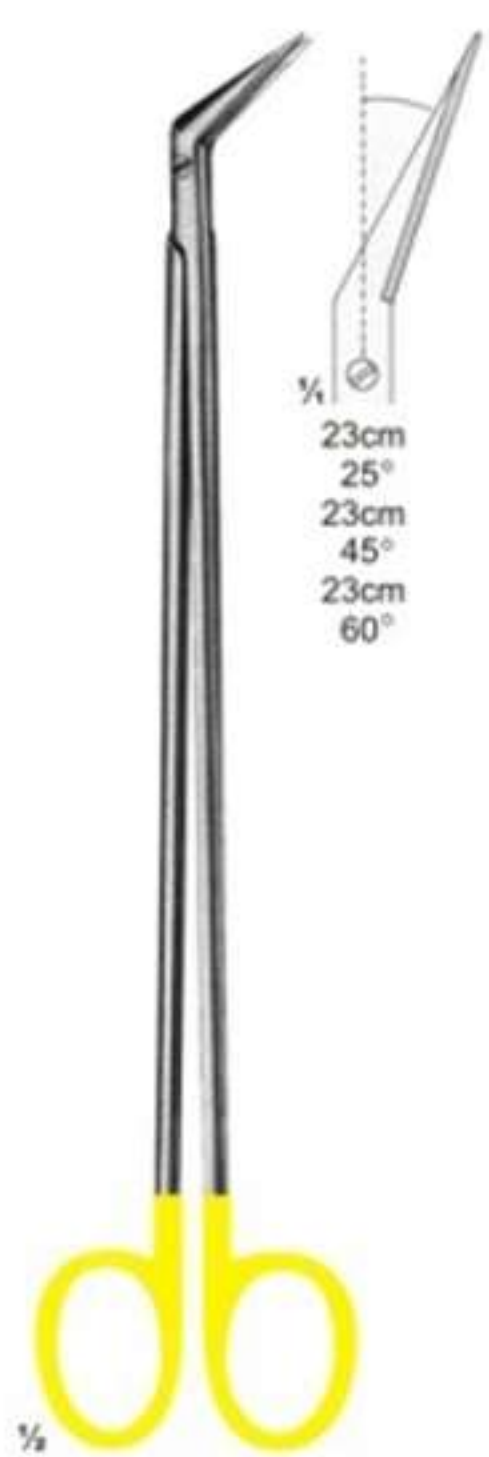

DMI-1-3528
De-Bakey 23cm 25 23cm 45 23cm 60



DMI-1-3529
De-Bakey 19cm 25 19cm 45 19cm 60

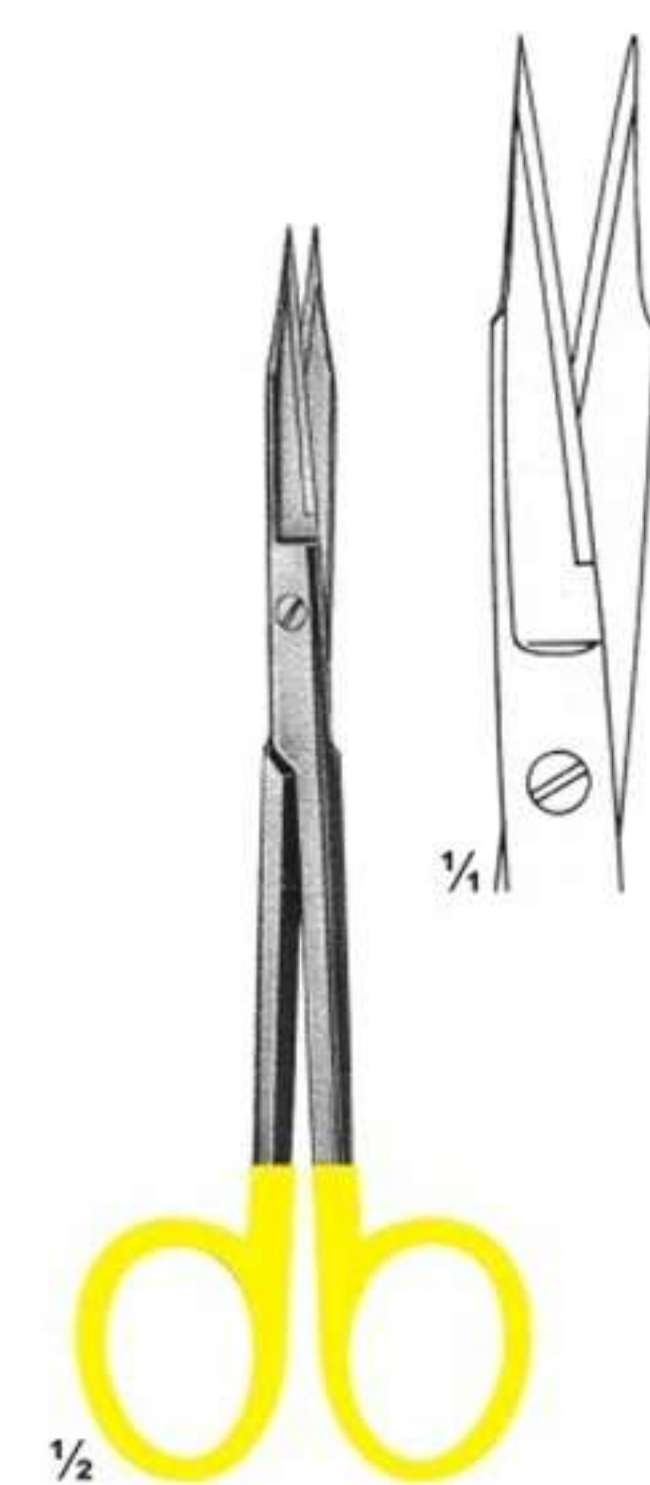

DMI-1-3530
Goldmann Fox 13cm

Scissors With Tungsten Carbide Inserts

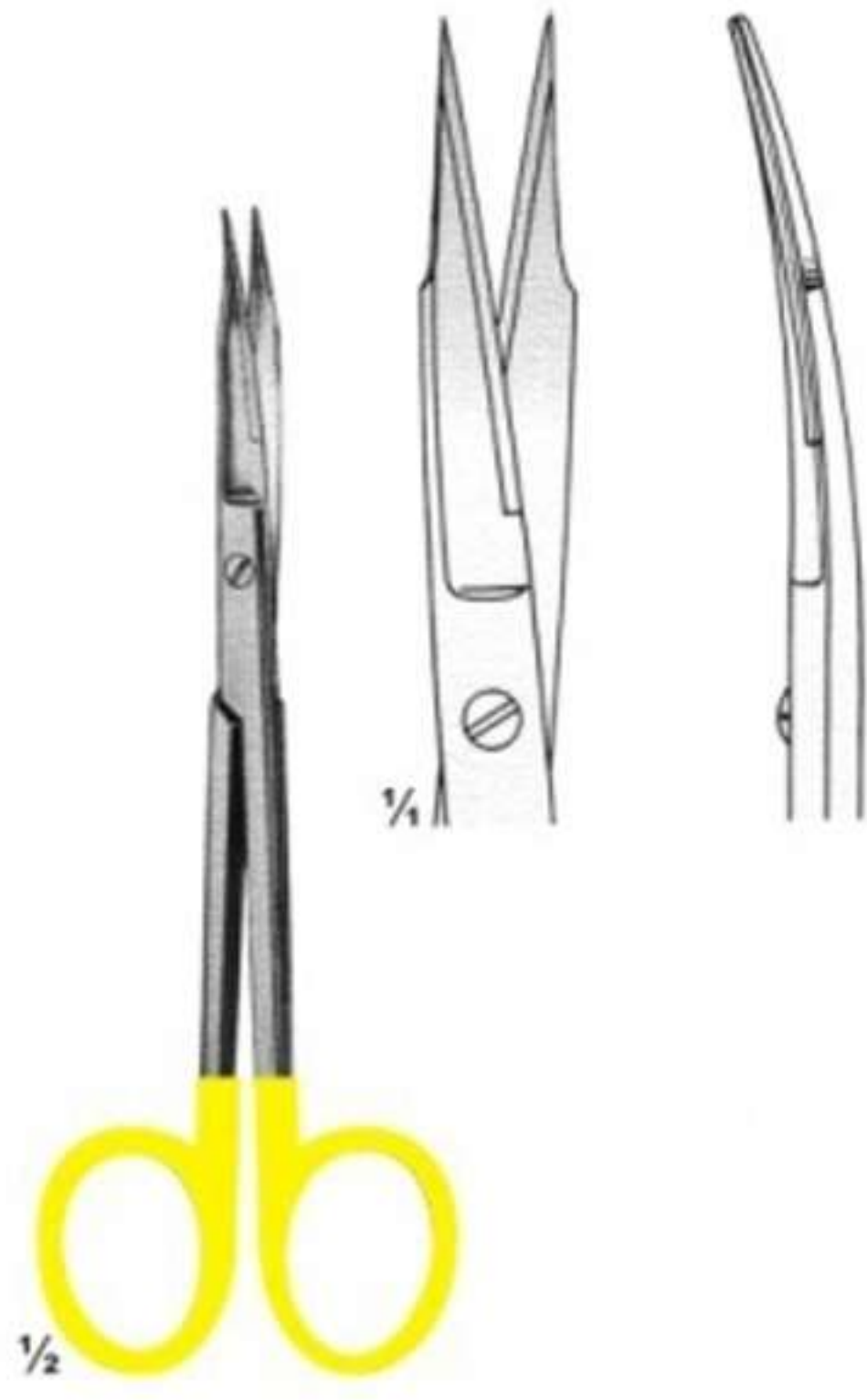

DMI-1-3530
Goldmann Fox 13cm

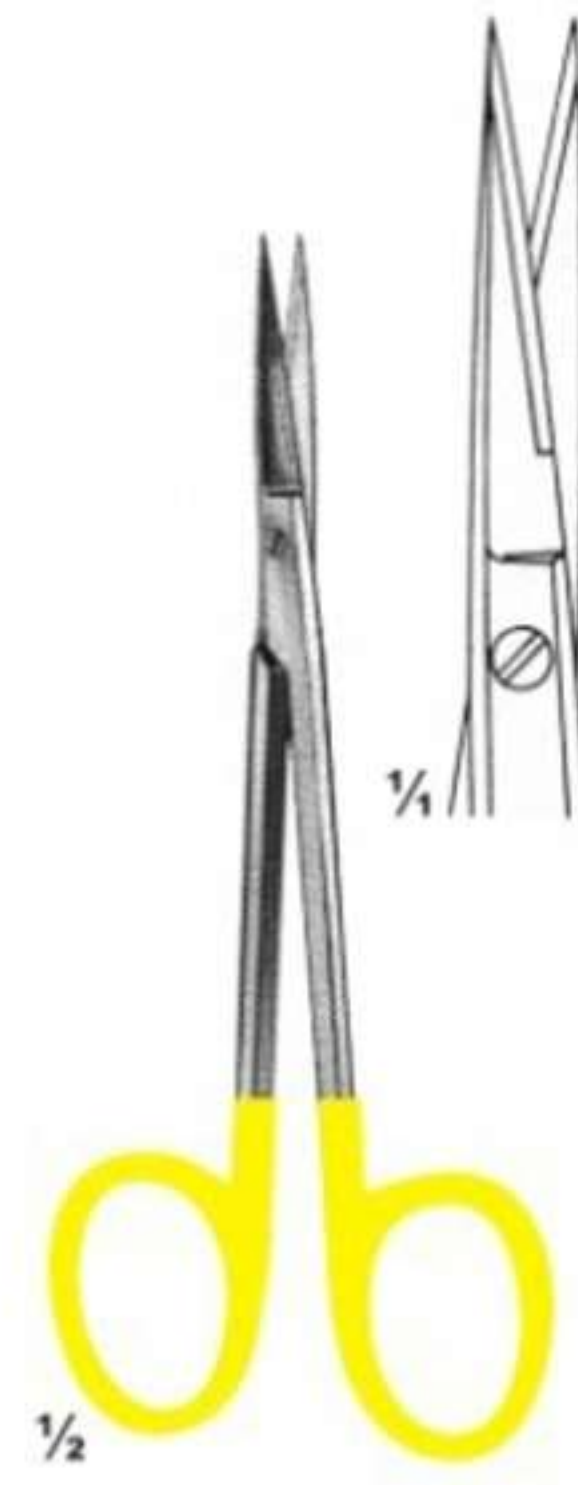

DMI-1-3531
Fine Scissor 11.5cm

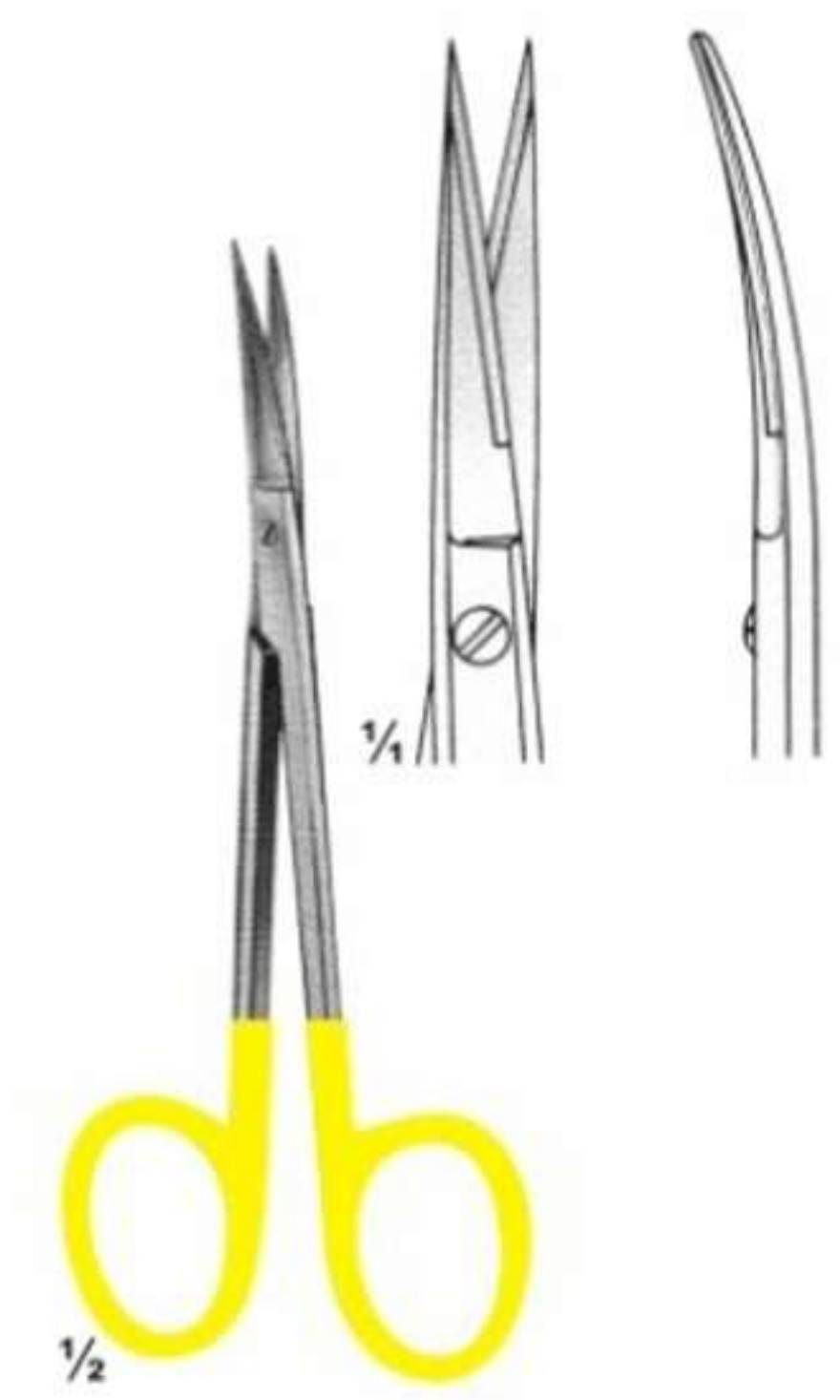

DMI-1-3532
Fine Scissor 11,5cm

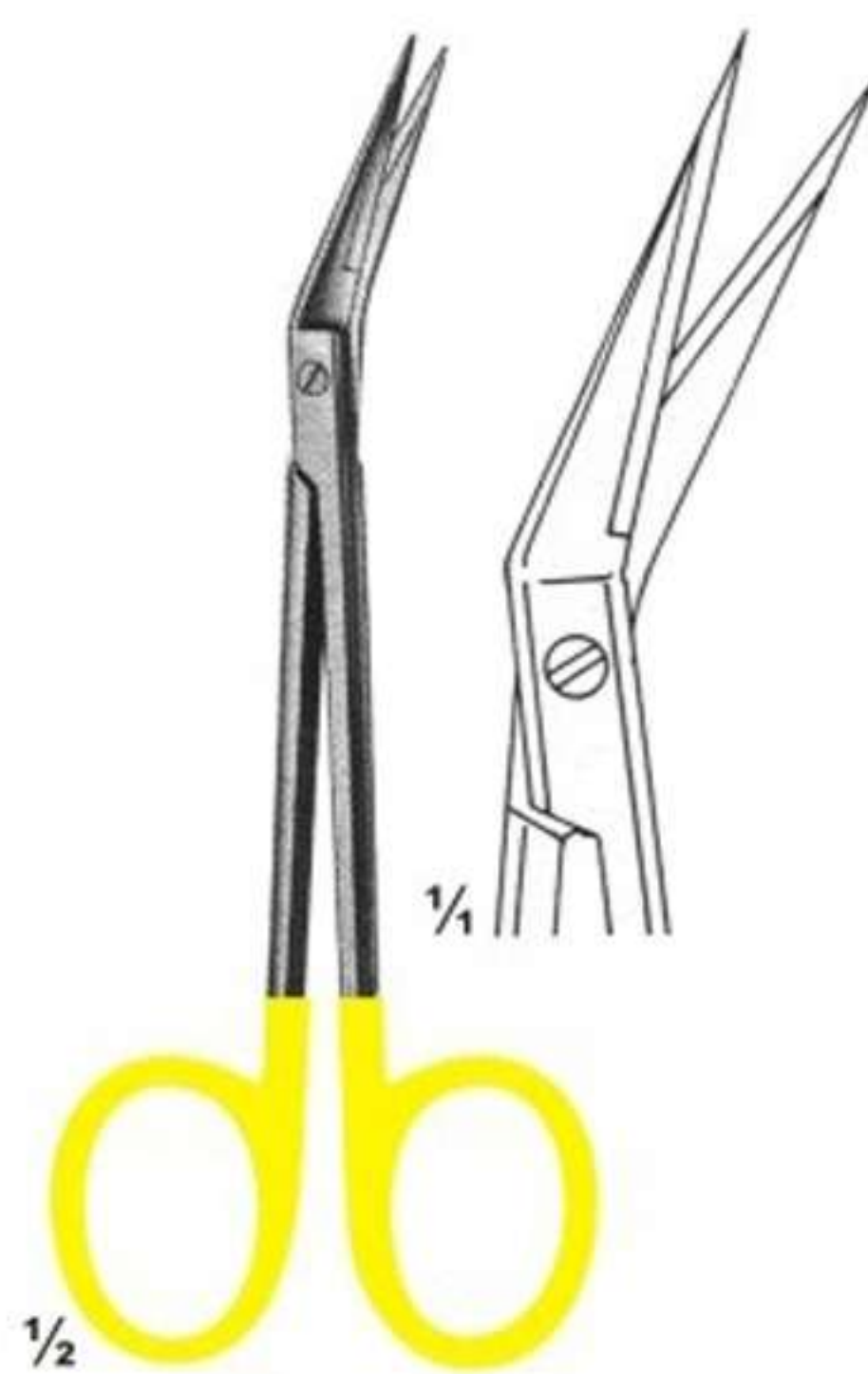

DMI-1-3533
11,5cm



DMI-1-3534
Ragnell 12cm

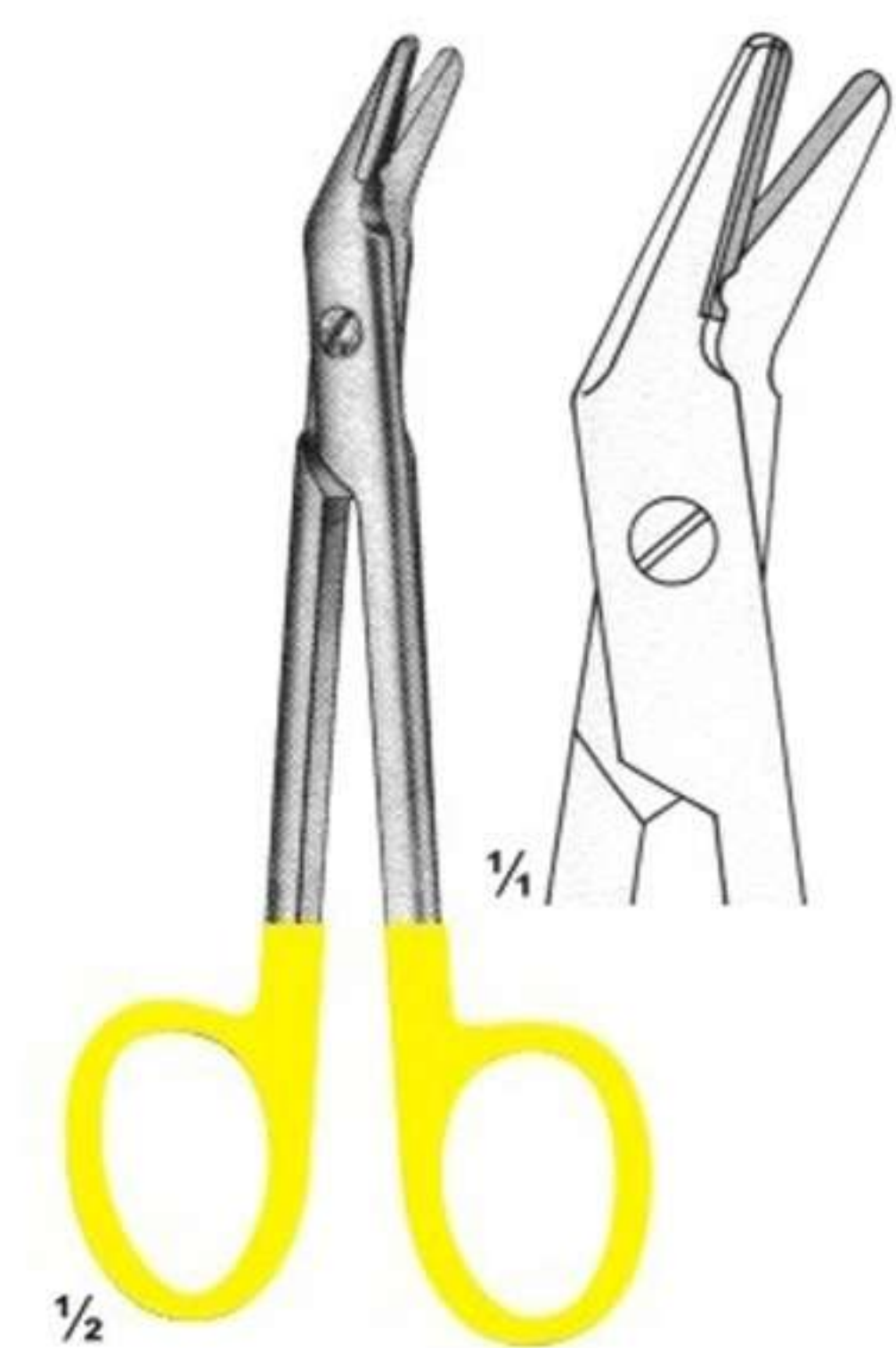

DMI-1-3535
Universal 12cm

Scissors With Tungsten Carbide Inserts



DMI-1-3536
Goldmann Fox 13cm

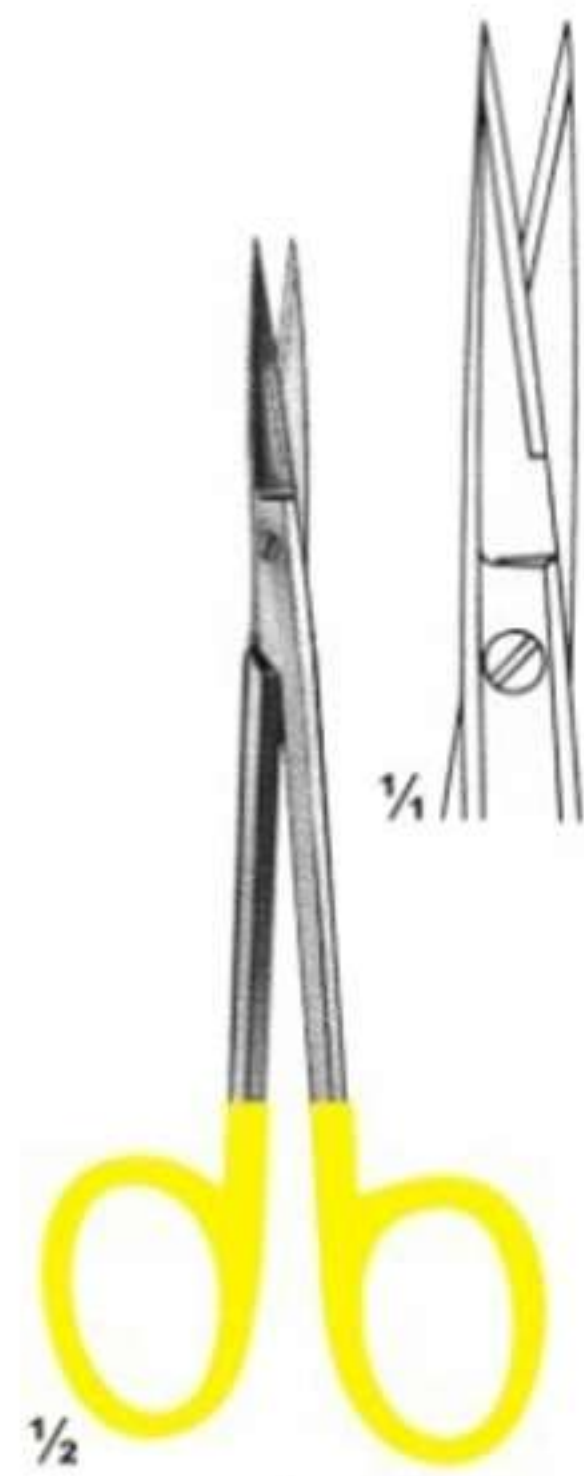

DMI-1-3537
Fine Scissor 11.5cm

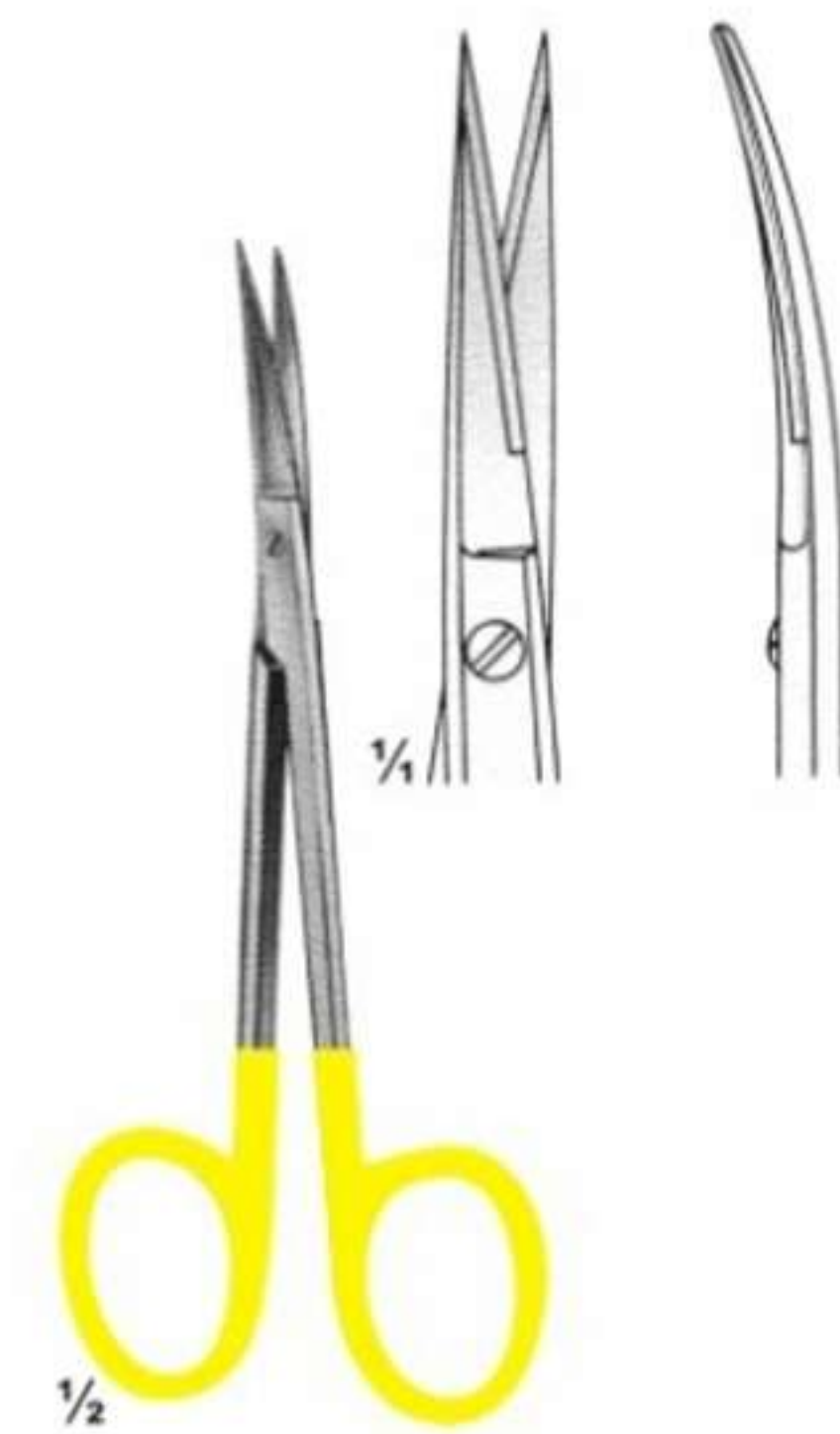

DMI-1-3538
Fine Scissor 11.5cm

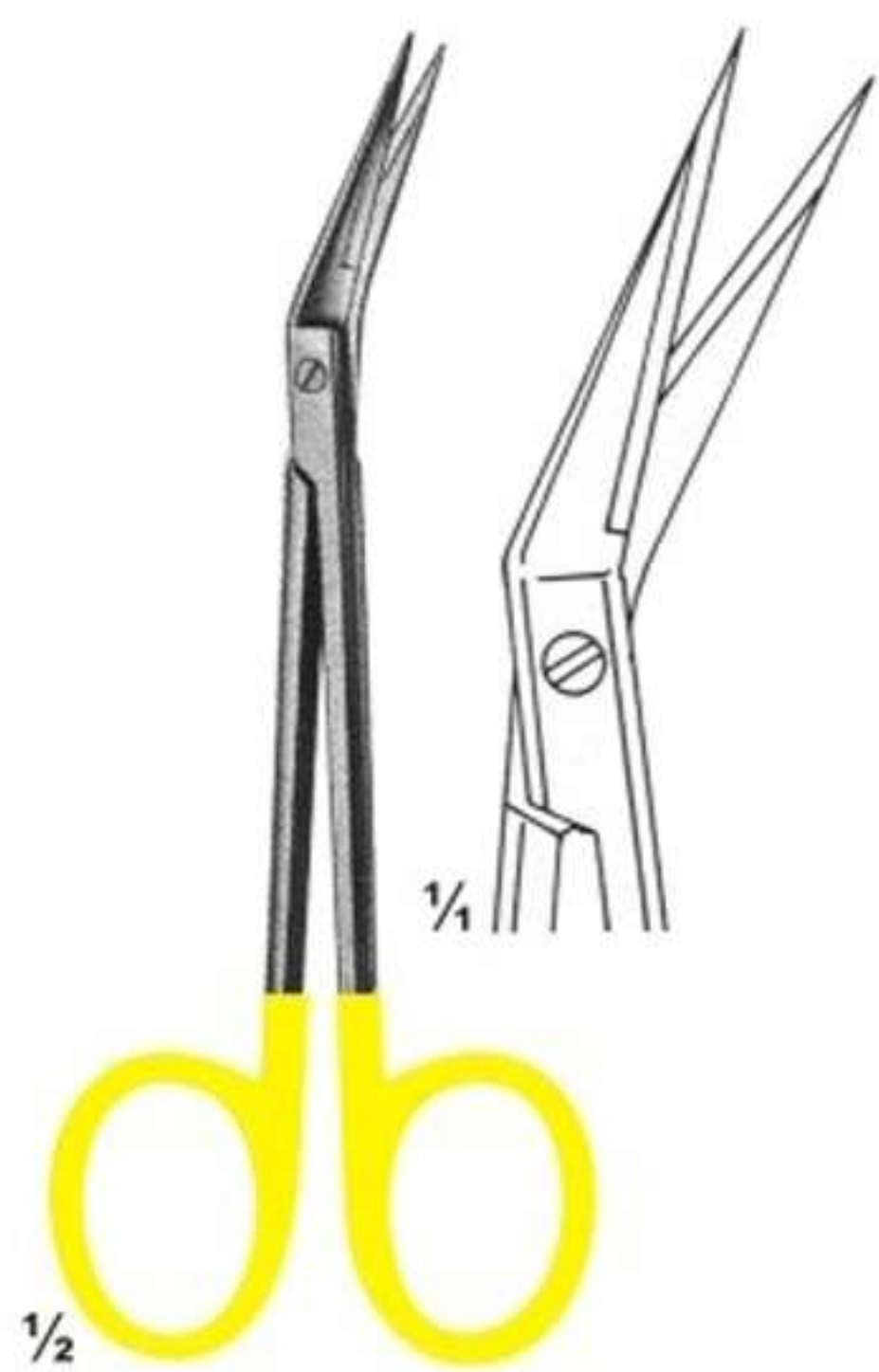

DMI-1-3539



DMI-1-3540
Ragnell 12cm

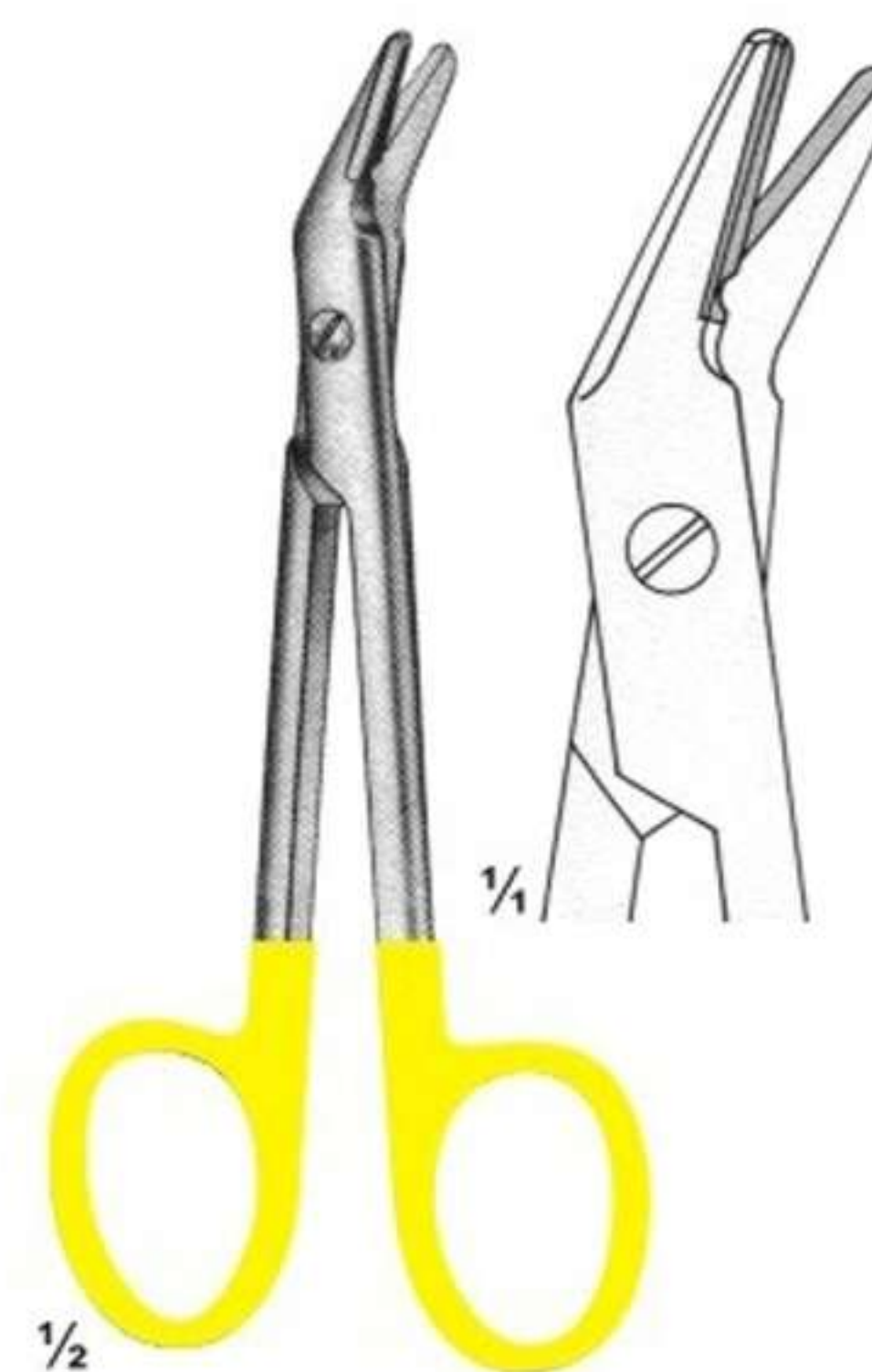

DMI-1-3541
Universal 12cm

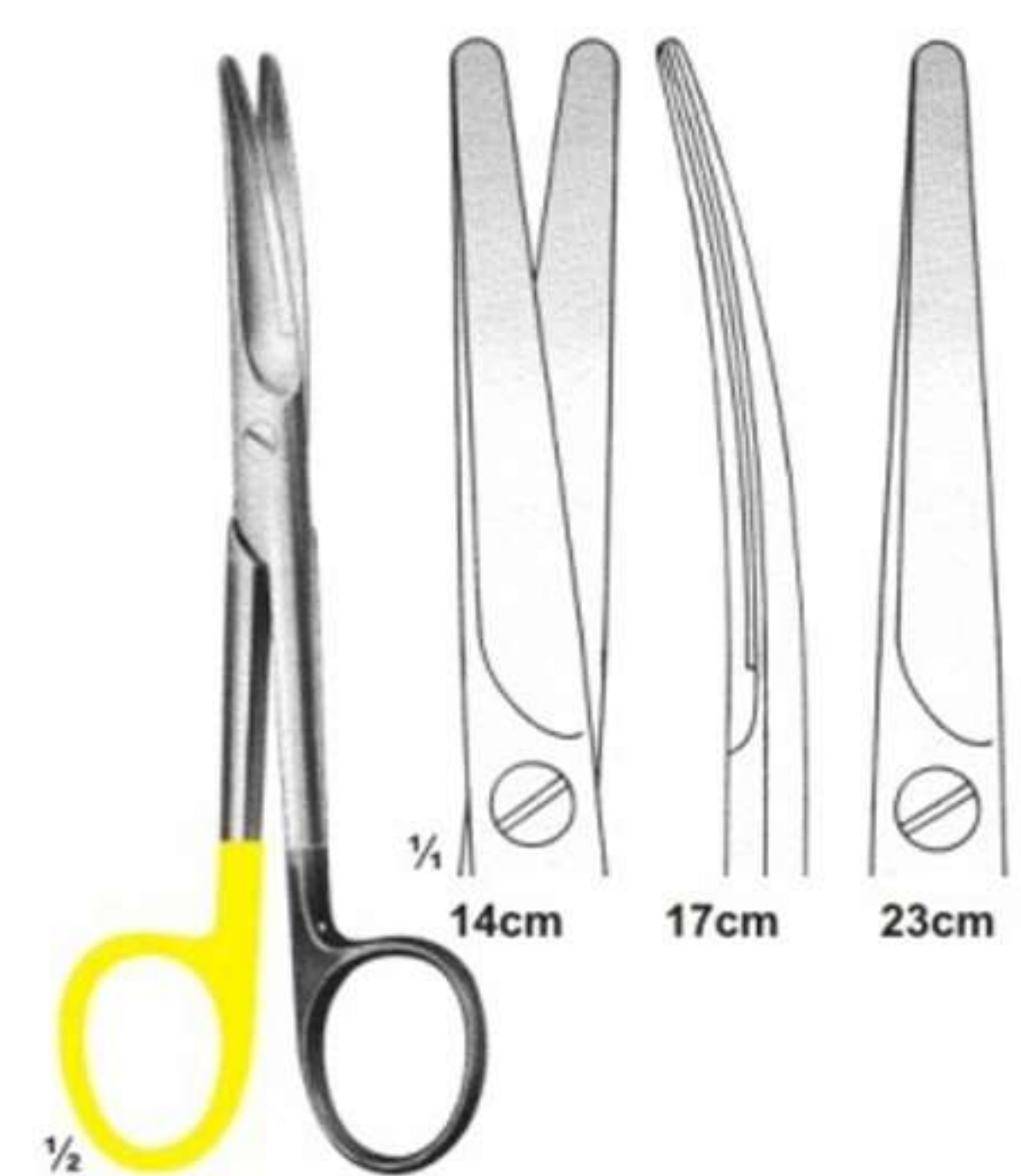

DMI-1-3542
Ligature Scissors 1 Black & 1 Goldplated ring

Dissecting Forceps with Tungsten Carbide Inserts

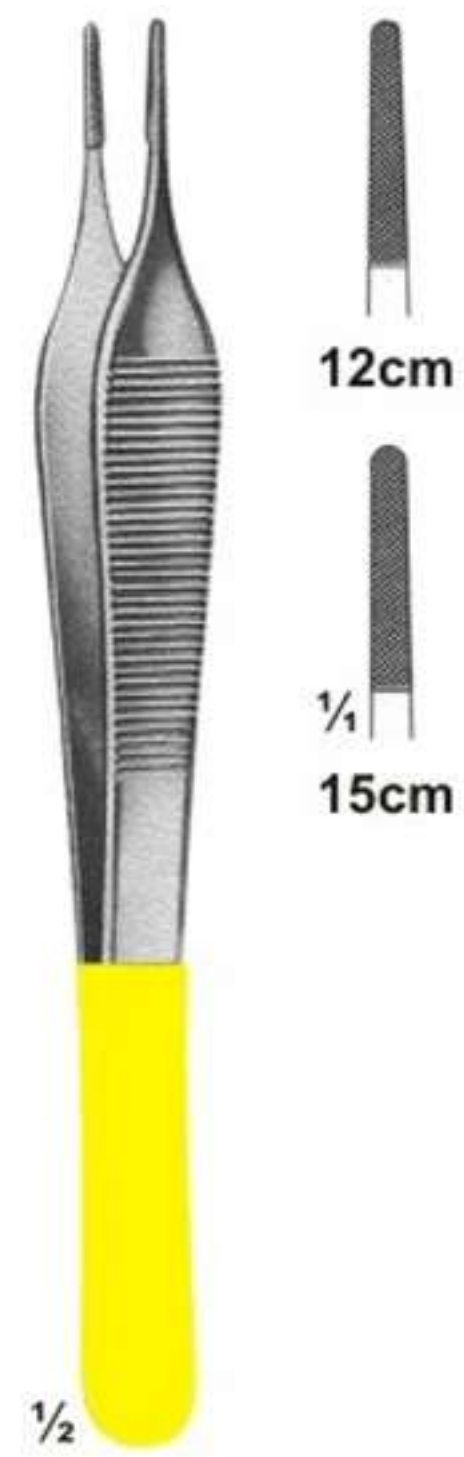

DMI-1-3601
Adson 12 cm 15 cm



DMI-1-3602
Cushing Cushing 17,5cm



DMI-1-3603
Cushing Cushing 18cm



DMI-1-3604
Cushing-Taylor 18cm



DMI-1-3605
Dissecting Forceps 15cm



DMI-1-3606
Semken 15cm

Dissecting Forceps with Tungsten Carbide Inserts



DMI-1-3607
Wangensteen 15cm23cm25cm

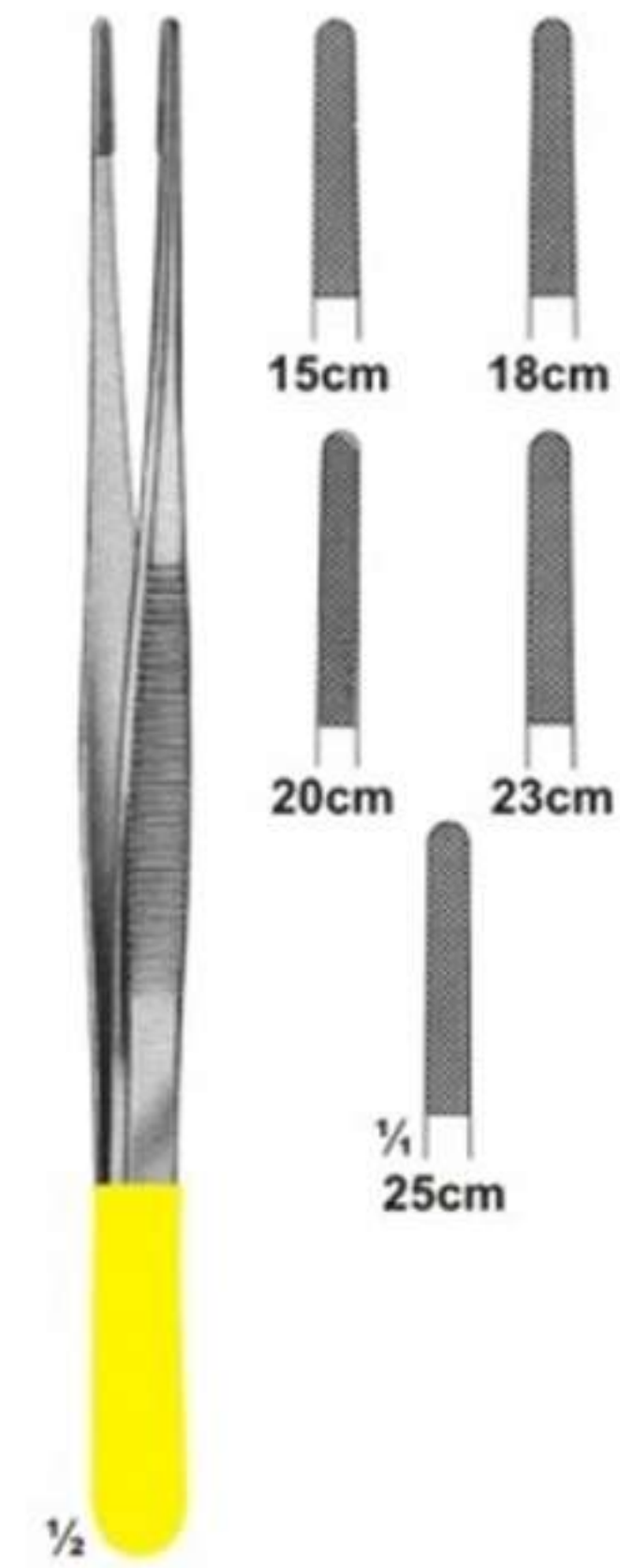

DMI-1-3608
Potts-Smith
15cm18cm20cm23cm25cm

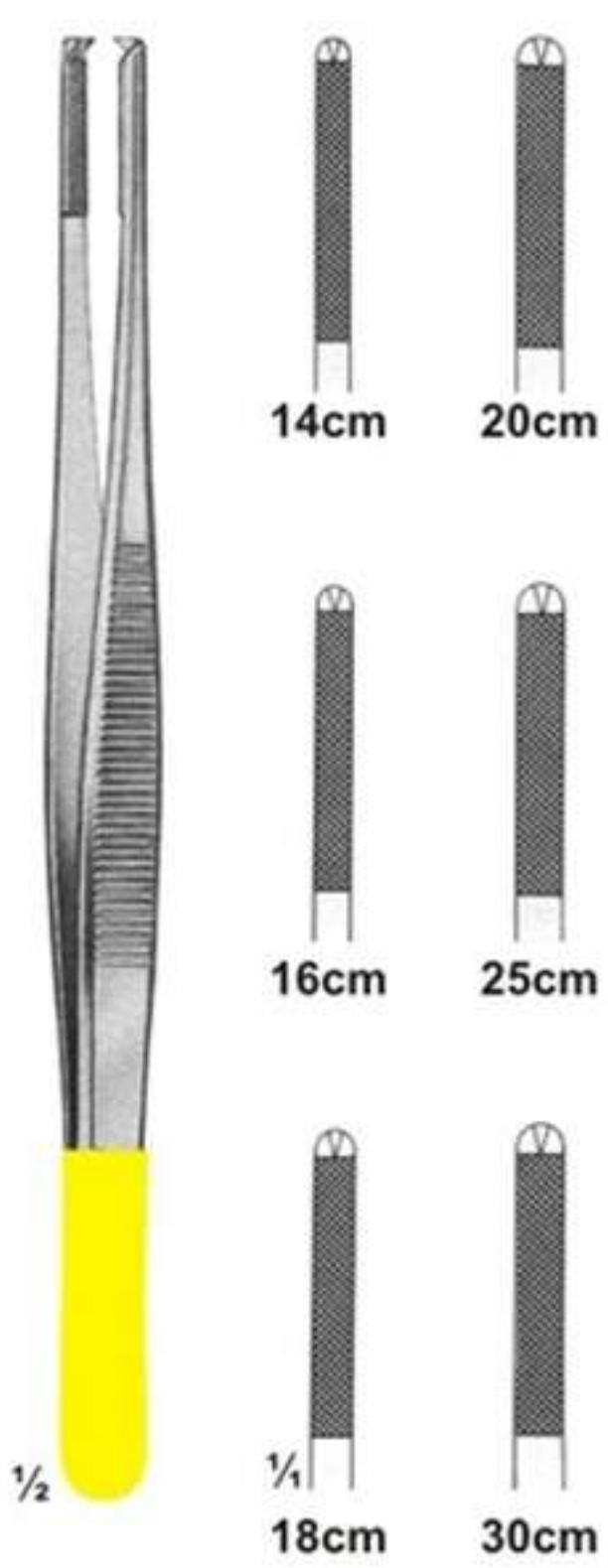

DMI-1-3609
Oehler
14cm16cm18cm20cm25cm30cm



DMI-1-3610
Potts-Smith22cm

Needle holders With Tungsten Carbide Inserts



DMI-1-3701
Hepp-Scheidle 18cm



DMI-3-3702
Castroviejo 14cm



DMI-3-3703
Castroviejo 14cm

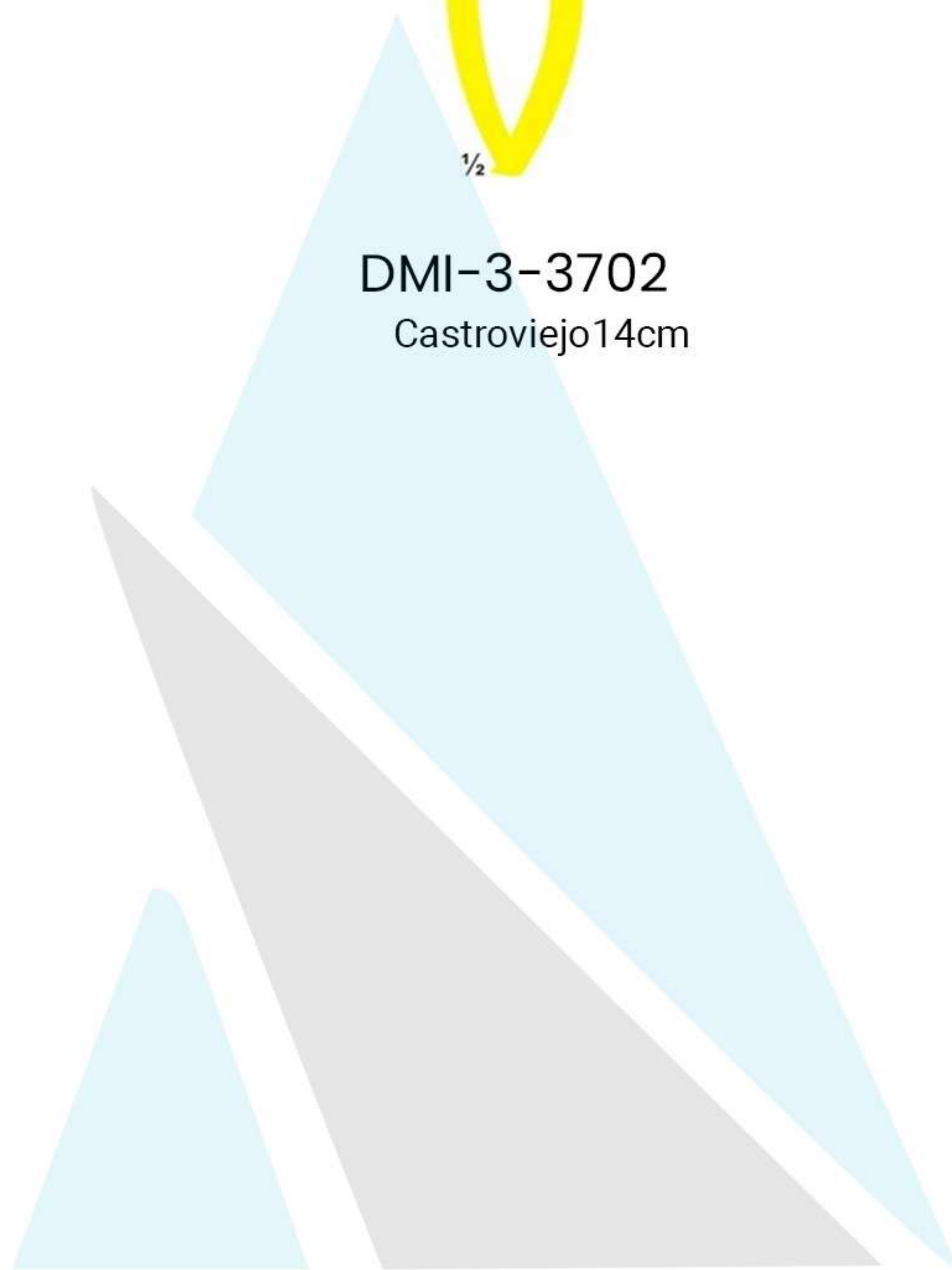

DMI-3-3704
Arruga 16cm



DMI-3-3705
Arruga 16cm



DMI-3-3706
Castroviejo 13cm

Needle holders With Tungsten Carbide Inserts

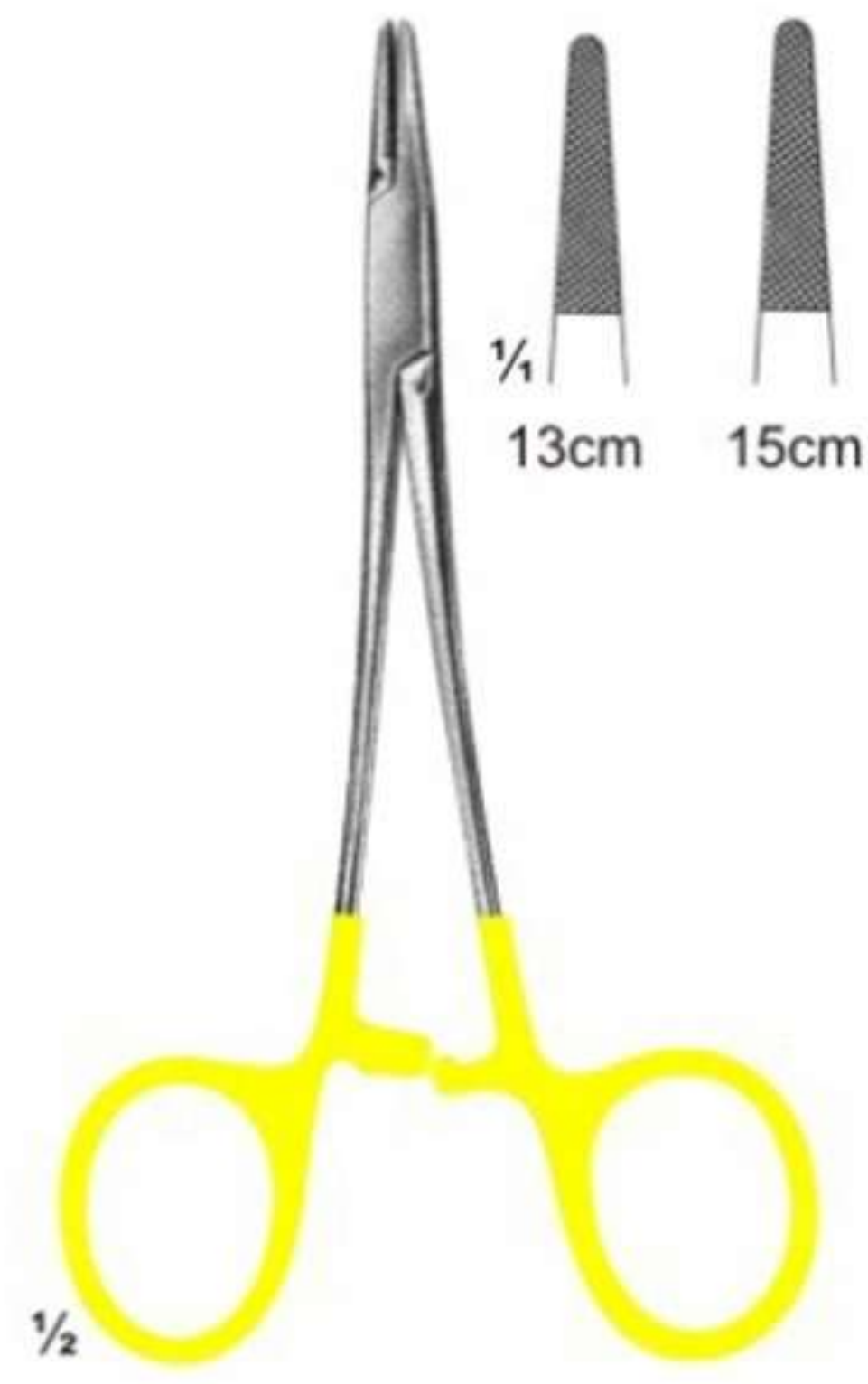

DMI-1-3707
Hegar 20cm 24cm

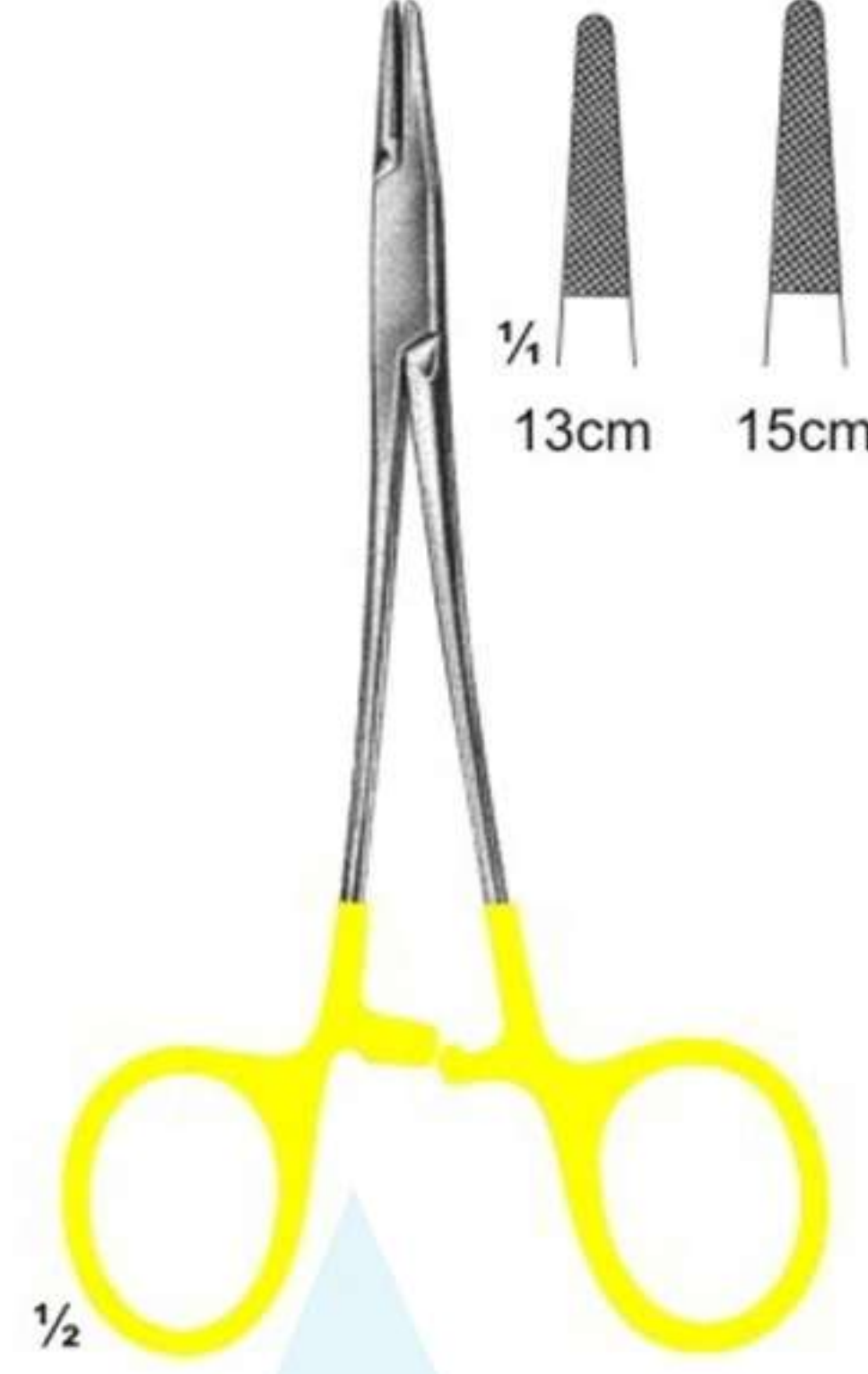

DMI-1-3708
Halsey 13cm 15cm

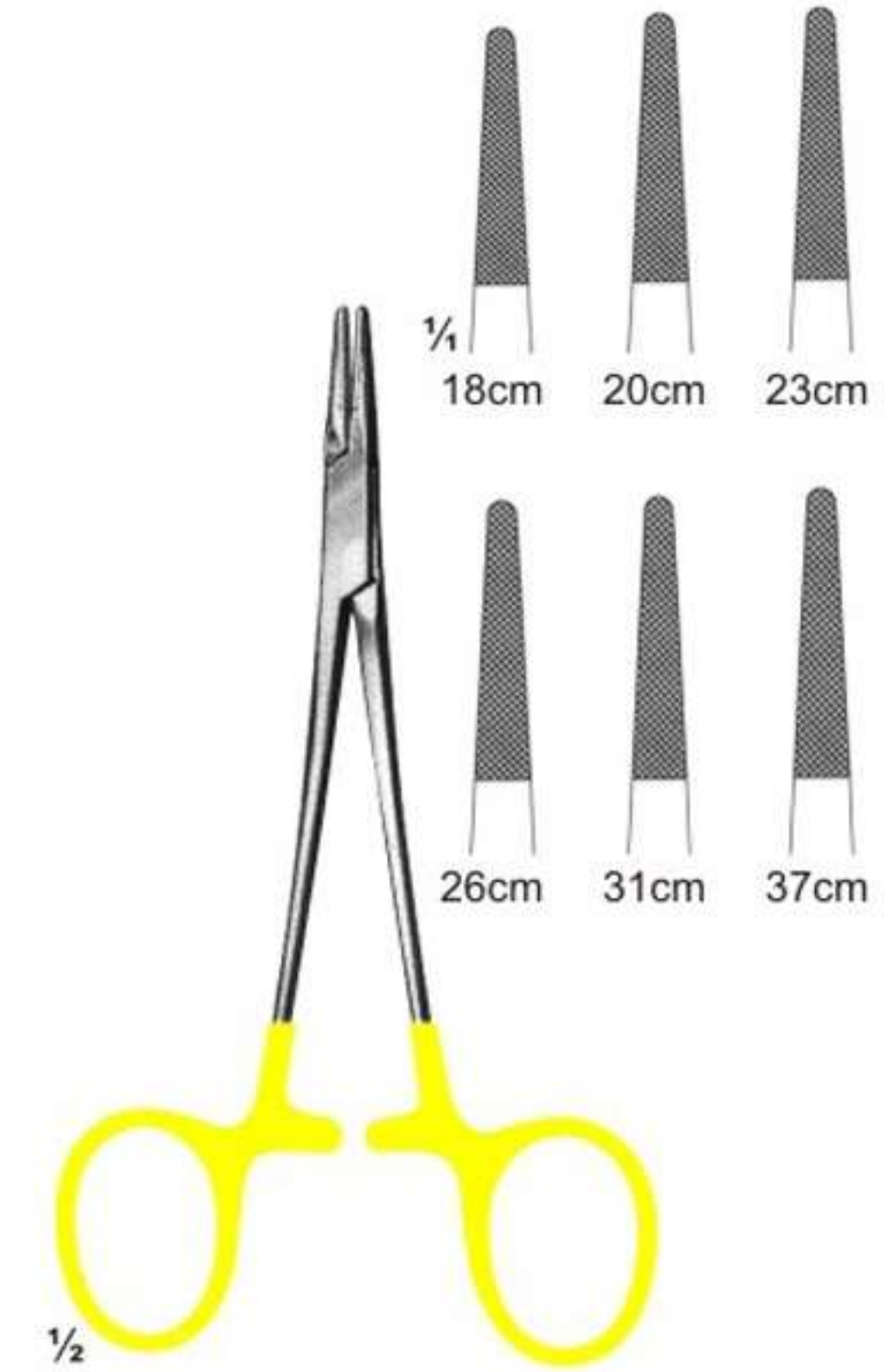

DMI-1-3709
Mayo-Hegar
16cm 18cm 20cm 24cm 26cm 30cm

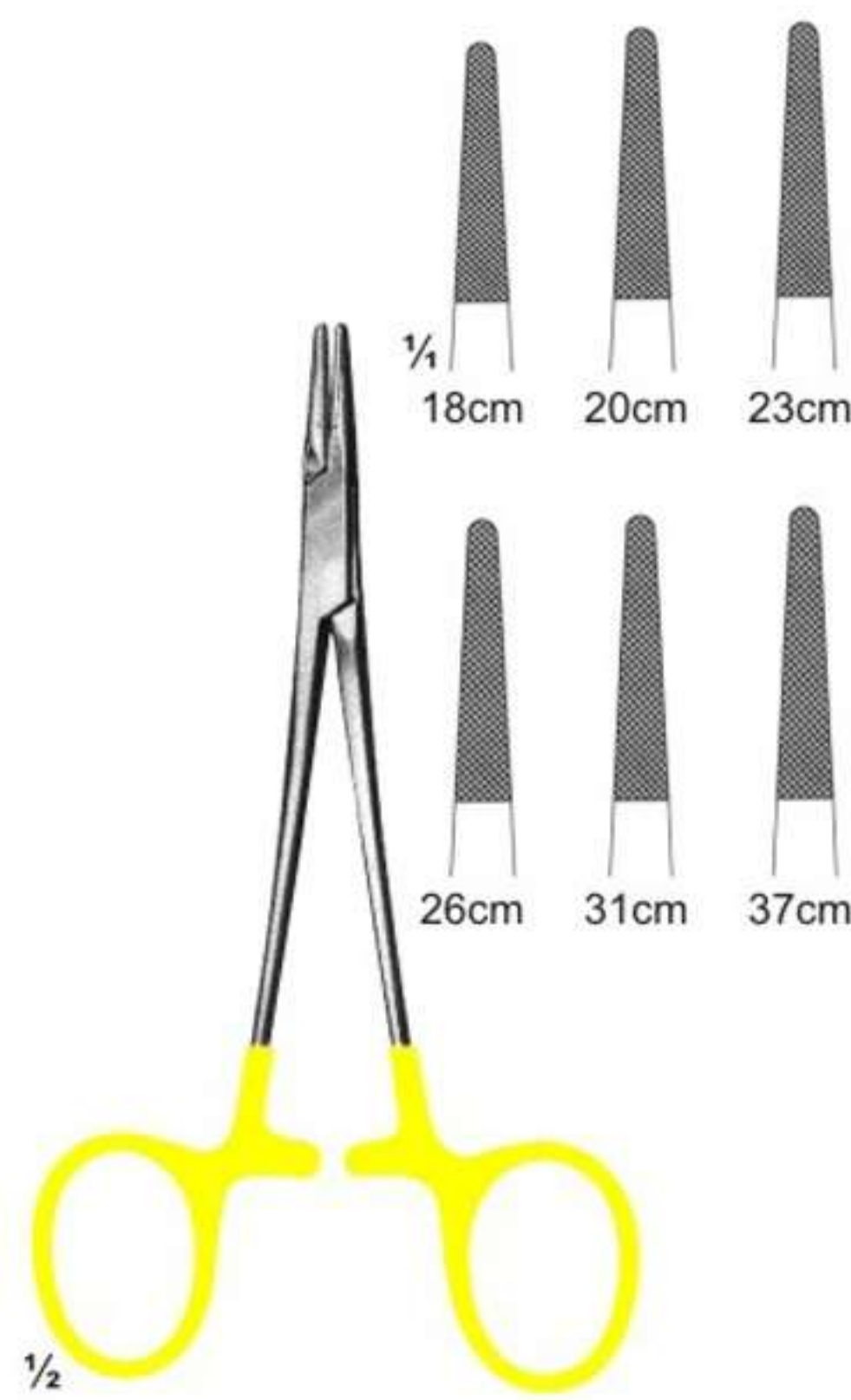

DMI-1-3710
De-Bakey
18cm 20cm 23cm 26cm 31cm 37cm

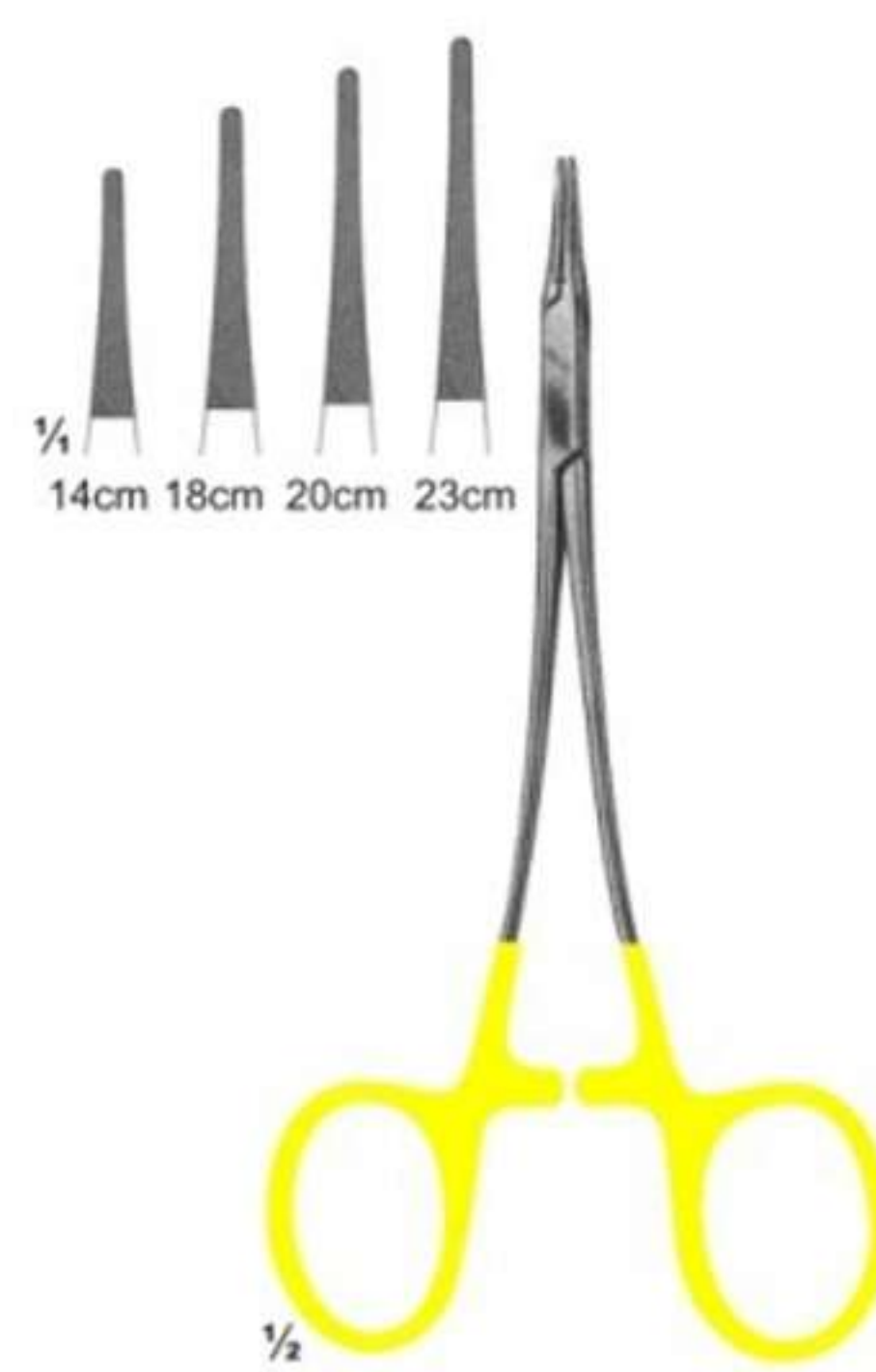

DMI-1-3711
Hegar-Vascular
14cm 18cm 20cm 23cm



DMI-1-3712
Bozemann-Wertheim 20cm 24cm 26cm

Needle holders With Tungsten Carbide Inserts



DMI-1-3713
Stratte 22cm 23cm

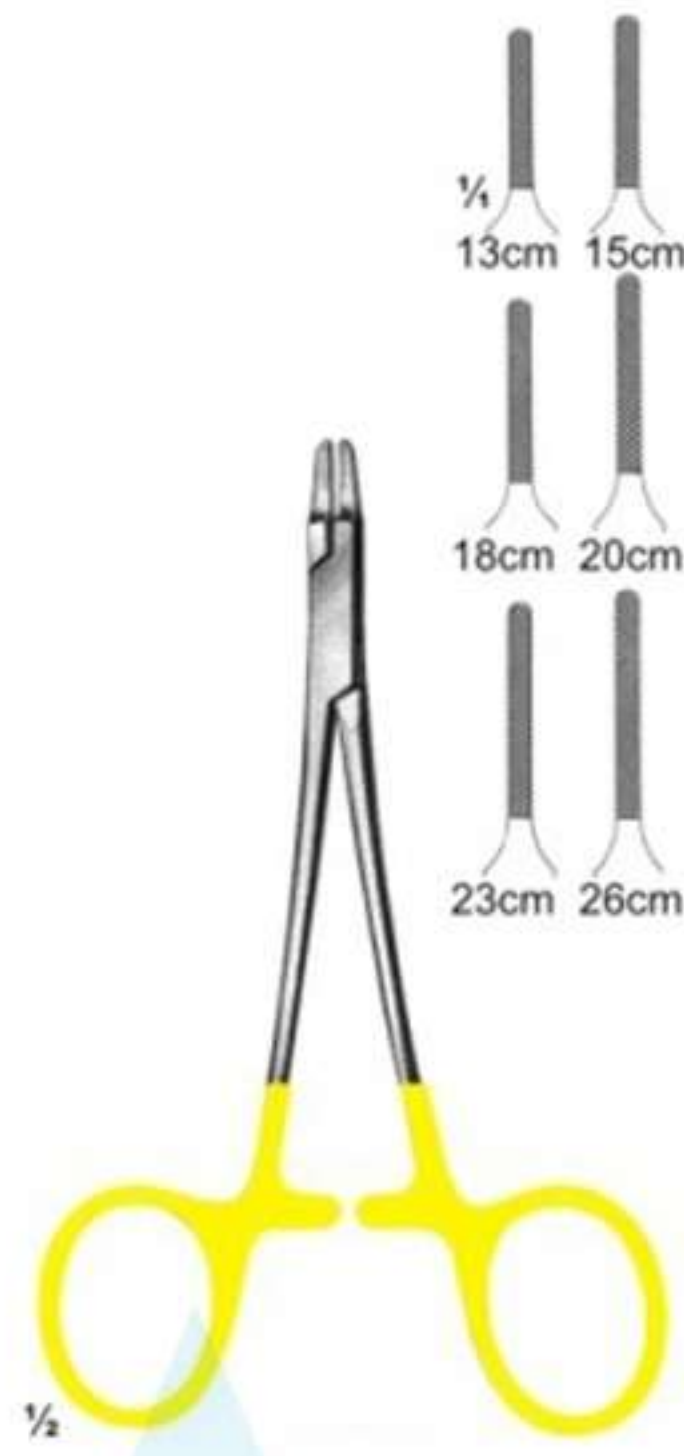

DMI-1-3714
Ryder 13cm 15cm 18cm 20cm 23cm 26cm



DMI-1-3715
Ryder-Vascular 13cm 15cm 18cm 20cm 23cm 26cm



DMI-1-3716
Martin
Martin 15cm 17cm 20cm



DMI-1-3717
Serot 18cm 20cm 26cm



DMI-1-3718
Finochietto 27cm

Needle holders With Tungsten Carbide Inserts



DMI-1-3719
Heaney 20cm 24cm

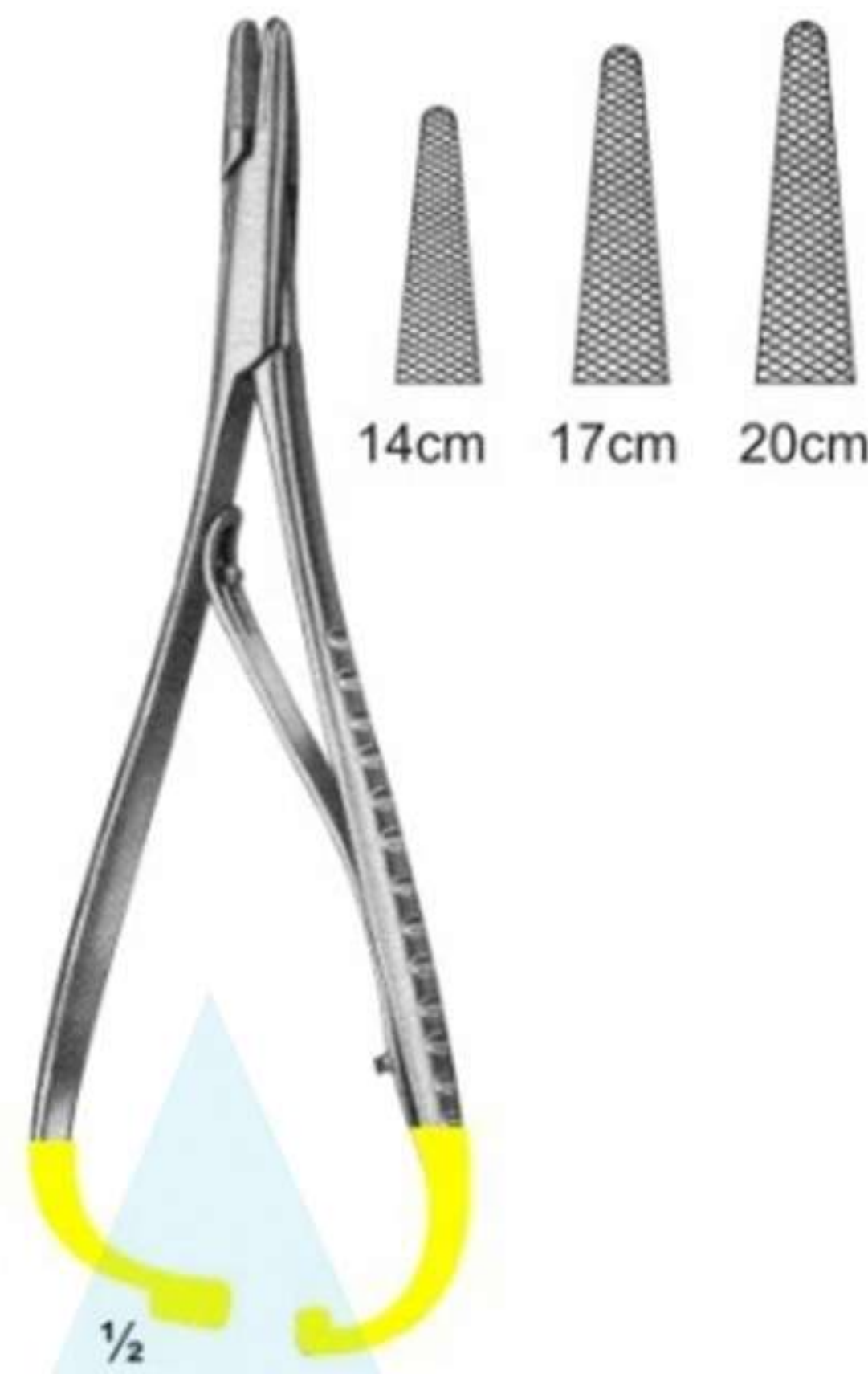

DMI-1-3720
Mathieu 14cm 17cm 20cm



DMI-1-3721
Mathieu 12cm 20cm 23cm



DMI-1-3722
Mathieu-Kosher 14cm 17cm 20cm 24cm



DMI-1-3723
Mathieu-Kosher 17cm 20cm 24cm



DMI-1-3724
Mathieu-Vascular 17cm 20cm 24cm

Needle holders With Tungsten Carbide Inserts



DMI-1-3725
Mathieu-Ryder 17cm 20cm 24cm



DMI-1-3726
Lichtenberg 20cm



DMI-1-3727
Langhals 20cm 25cm



DMI-1-3728
Lichtenberg 20cm 25cm



DMI-1-3729
Luehty-Beck 20cm 25cm



DMI-1-3730
Langebeck 18cm 20cm 23cm



DMI-1-3731
Langebeck-beck 18cm 20cm 23cm

CONTACT US

ADDRESS: DEFFENCE ROAD, MUZAFFAR PUR,
NEAR HOTEL JAFSON, Sialkot Pakistan

PHONE: +92 304 9892558/ 345 6995503

E-MAIL: info@Dentalmountaininstruments.com

WEB: www.dentalmountaininstruments.com